



US00D981053S

(12) **United States Design Patent**
Becattini, Jr. et al.

(10) **Patent No.:** **US D981,053 S**
(45) **Date of Patent:** **** Mar. 14, 2023**

(54) **FEEDING MAT**

amazon.com/Mighty-Paw-BPA-Free-Silicone-Dishwasher/dp/B08M3ZRL7V?th=1 (Year: 2020).*

(71) Applicant: **Towerstar Pets, LLC**, Malvern, PA (US)

(Continued)

(72) Inventors: **Fernando Becattini, Jr.**, Malvern, PA (US); **Jacquelyn N. Becattini**, Malvern, PA (US); **Steve A. Copeland**, Barrie (CA)

Primary Examiner — Katrina N Gonzalez

(74) *Attorney, Agent, or Firm* — Sand, Sebolt & Wernow Co., LPA

(73) Assignee: **Towerstar Pets, LLC**, Malvern, PA (US)

(57) **CLAIM**

The ornamental design for a feeding mat, as shown and described.

(**) Term: **15 Years**

DESCRIPTION

(21) Appl. No.: **29/754,908**

FIG. 1 is a top left front perspective view of a feeding mat in accordance with our design.

(22) Filed: **Oct. 15, 2020**

FIG. 2 is a top right front perspective view of a feeding mat in accordance with our design.

(51) **LOC (14) Cl.** **30-07**

FIG. 3 is a bottom left front perspective view of a feeding mat in accordance with our design.

(52) **U.S. Cl.**

USPC **D30/121; D30/199**

FIG. 4 is a front elevation plan view of a feeding mat in accordance with our design.

(58) **Field of Classification Search**

USPC **D30/121, 122, 129-133, 199; 119/51.01, 119/51.02, 51.03, 51.11, 51.15, 51.5, 70,**

FIG. 5 is a rear elevation plan view of a feeding mat in accordance with our design.

(Continued)

FIG. 6 is a right side elevation plan view of a feeding mat in accordance with our design.

(56) **References Cited**

U.S. PATENT DOCUMENTS

8,534,225 B2 9/2013 Vermeegen
D709,247 S 7/2014 Gailen

(Continued)

FIG. 7 is a left side elevation plan view of a feeding mat in accordance with our design.

FIG. 8 is a top plan view of a feeding mat in accordance with our design.

FOREIGN PATENT DOCUMENTS

WO 20190188 1/2019

FIG. 9 is a bottom plan view of a feeding mat in accordance with our design; and,

FIG. 10 is a cross-sectional front view of a feeding mat taken along and in the direction of line 10-10 in FIG. 8 in accordance with our design.

OTHER PUBLICATIONS

“Mighty Paw Dog Lick Pad” available Oct. 28, 2020, [online], [site visited Sep. 26, 2022]. Retrieved from Internet, URL:<https://www.>

The dash-dash broken lines illustrate portions of the feeding mat. The dot-dot-dash broken lines in FIGS. 1-3, 8, and 9, represent the bounds of the claim. The dot-dot-dash broken lines in FIG. 10 represent the bounds of the cross-sectional view. The broken lines form no part of the claimed design.

1 Claim, 7 Drawing Sheets

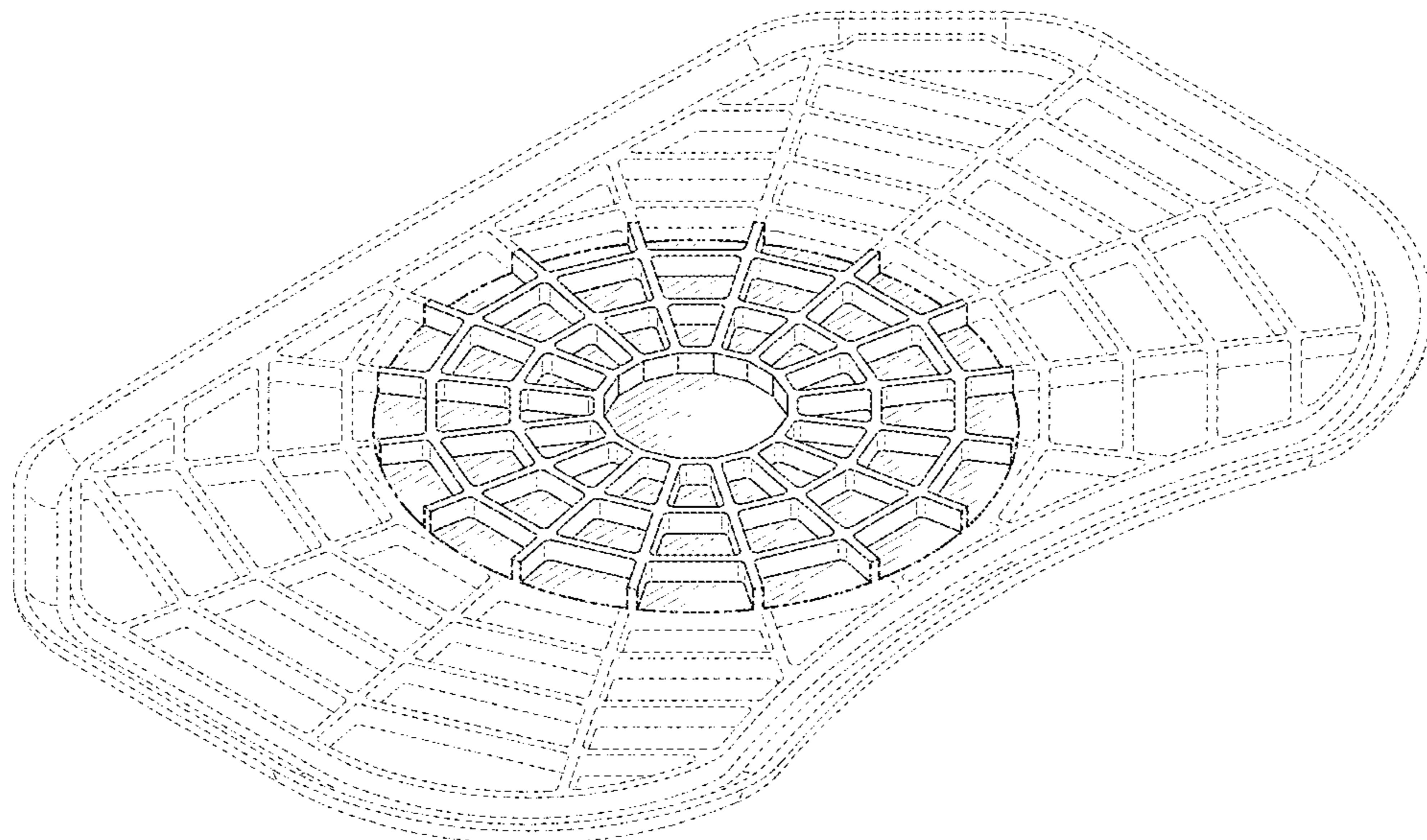

(58) **Field of Classification Search**

USPC 119/52.1, 52.3, 52.4, 53, 53.5, 54, 57.92,
 119/61.1, 61.3, 61.5, 61, 61.53, 61.54,
 119/61.55, 68, 72, 73, 74, 75, 78, 174
 CPC . A01K 5/00; A01K 7/00; A01K 39/02; A01K
 39/04; A01K 39/0213; A01K 5/0121;
 A01K 5/0135; A01K 7/005
 See application file for complete search history.

(56) **References Cited**

U.S. PATENT DOCUMENTS

8,844,466	B2	9/2014	Vermeegan	
D725,317	S	3/2015	Avalos Sartorio et al.	
D727,576	S	4/2015	Avalos Sartorio et al.	
D749,274	S	2/2016	Gailen	
D751,773	S	3/2016	Gailen	
D912,913	S *	3/2021	Wendling	D30/161
D914,996	S *	3/2021	Xie	D30/121
D915,686	S *	4/2021	Becattini, Jr.	D30/129
D926,395	S *	7/2021	Mei	D30/161
D927,795	S *	8/2021	Clarke	D30/121
D927,796	S *	8/2021	Clarke	D30/121
D929,679	S *	8/2021	Elliott	D30/161
D937,500	S *	11/2021	Wu	D30/121
2017/0071155	A1	3/2017	Gailen et al.	
2020/0196566	A1	6/2020	Clarke et al.	

OTHER PUBLICATIONS

“8 Tasty Treat Suggestions for the Neat-Lik Mat” available Aug. 11, 2021, [online], [site visited Sep. 26, 2022]. Retrieved from Internet,

URL:<https://neaterpets.com/blogs/news/neat-lik-mat-treat-suggestions> (Year: 2021).*

“Neater Pets Walmart” available Jul. 12, 2021, [online], [site visited Sep. 26, 2022]. Retrieved from Internet, URL:<https://www.walmart.com/reviews/product/858122977?sort=submission-asc> (Year: 2021).*

“Neater Pets Facebook” available Jul. 14, 2021, [online], [site visited Sep. 26, 2022]. Retrieved from Internet, URL:[facebook.com/NeaterPets/photos/3001198126794819](https://www.facebook.com/NeaterPets/photos/3001198126794819) (Year: 2021).*

“Neater Pets Amazon” available Nov. 20, 2020, [online], [site visited Sep. 26, 2022]. Retrieved from Internet, URL:[amazon.com/Neater-Pets-Neat-LIK-Feeding-Provide/dp/B08NXT5FRL?tag=rovetrx544-20](https://www.amazon.com/Neater-Pets-Neat-LIK-Feeding-Provide/dp/B08NXT5FRL?tag=rovetrx544-20) (Year: 2020).*

“14" Black Felt Spiderweb Placemat” available Sep. 29, 2022, [online], [site visited Sep. 29, 2022]. Retrieved from Internet, URL:[michaels.com/14in-black-felt-spiderweb-placemat-by-celebrate-it/10695937.html](https://www.michaels.com/14in-black-felt-spiderweb-placemat-by-celebrate-it/10695937.html) (Year: 2022).*

“Spider web hot pot holder” available Nov. 21, 2016, [online], [site visited Sep. 29, 2022]. Retrieved from Internet, URL:<https://www.iforgeiron.com/topic/48887-spider-web-hot-pot-holder/> (Year: 2016).*

“Spider Web—Laser Cut Out” available Jun. 20, 2019, [online], [site visited Sep. 29, 2022]. Retrieved from Internet, URL:[etsy.com/listing/225154812/spider-web-laser-cut-out-unfinished-wood](https://www.etsy.com/listing/225154812/spider-web-laser-cut-out-unfinished-wood) (Year: 2019).*

“Halloween Spider web silicone trivets” available Sep. 29, 2022, [online], [site visited Sep. 29, 2022]. Retrieved from Internet, URL:<https://www.silife365.com/product/halloween-spider-web-silicone-trivets-best-heat-resistant-countertop-protectors/> (Year: 2022).*

“Unmarked—3-497—Speaker, grill. Round spider web pattern_” available May 22, 2015, [online], [site visited Sep. 29, 2022]. Retrieved from Internet, URL:https://web.archive.org/web/20150601000000*/https://www.electronicssurplus.com/3-497-speaker-grill-round-spider-web-pattern (Year: 2015).*

* cited by examiner

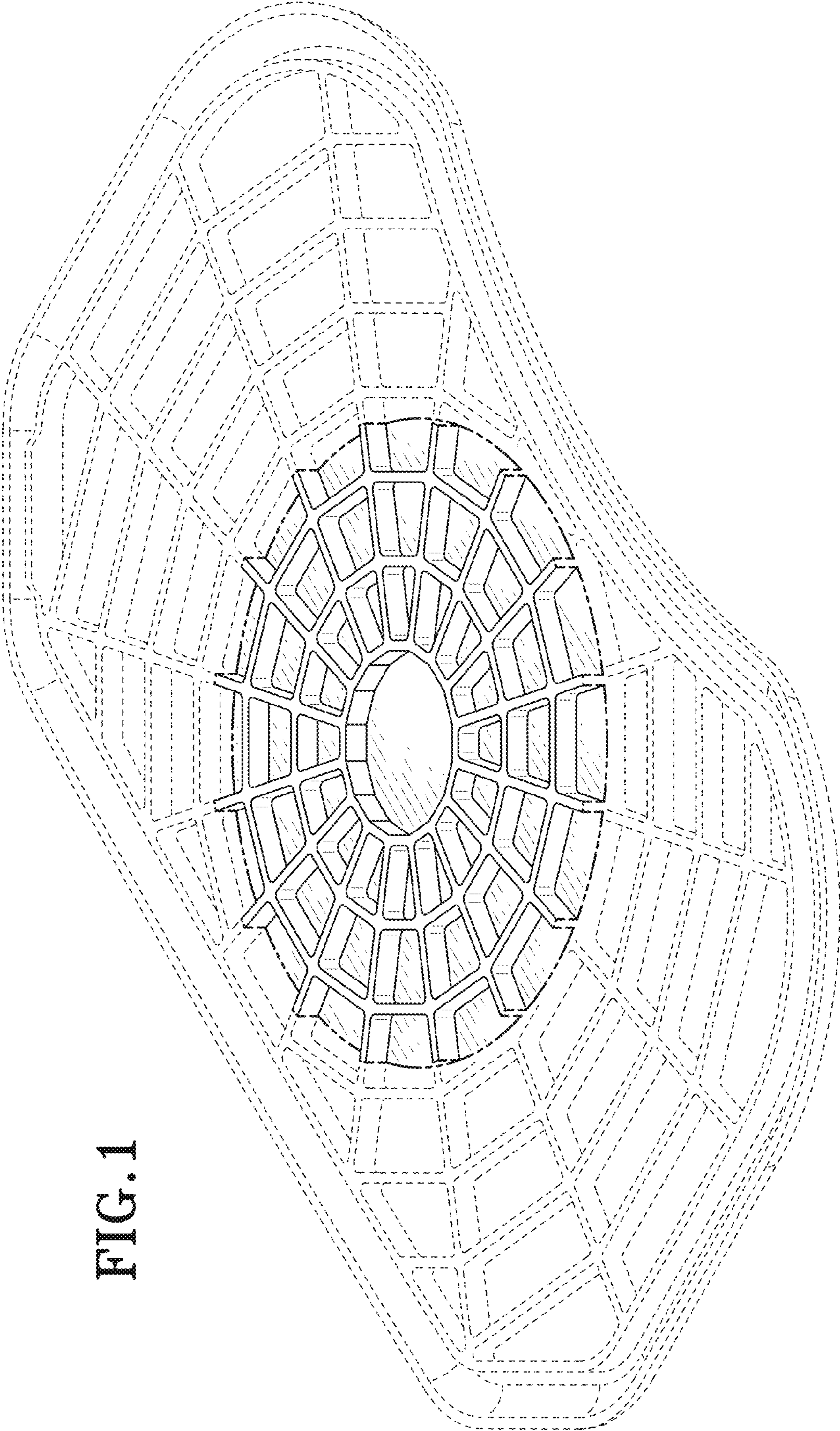
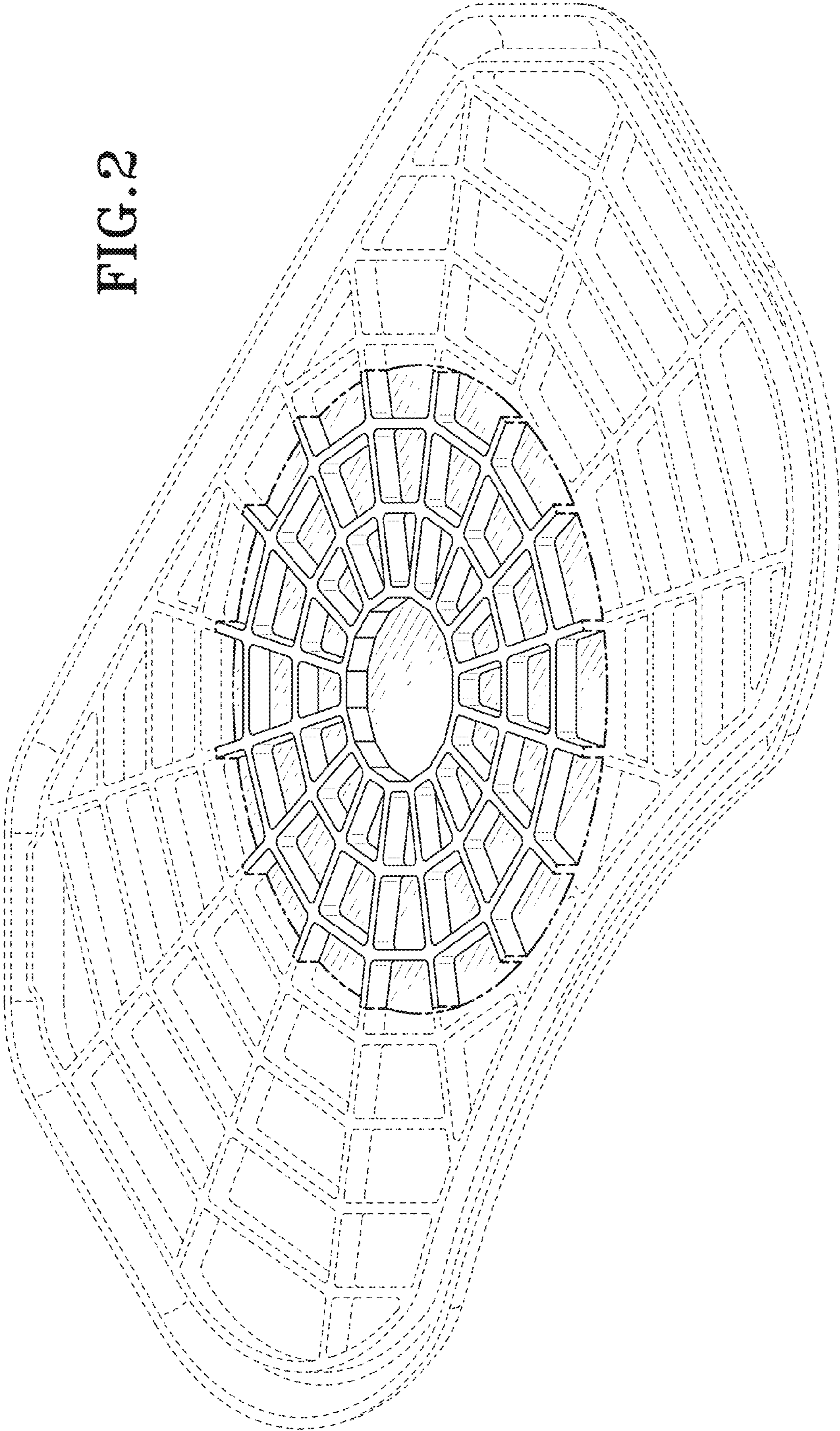

FIG. 1

FIG. 2



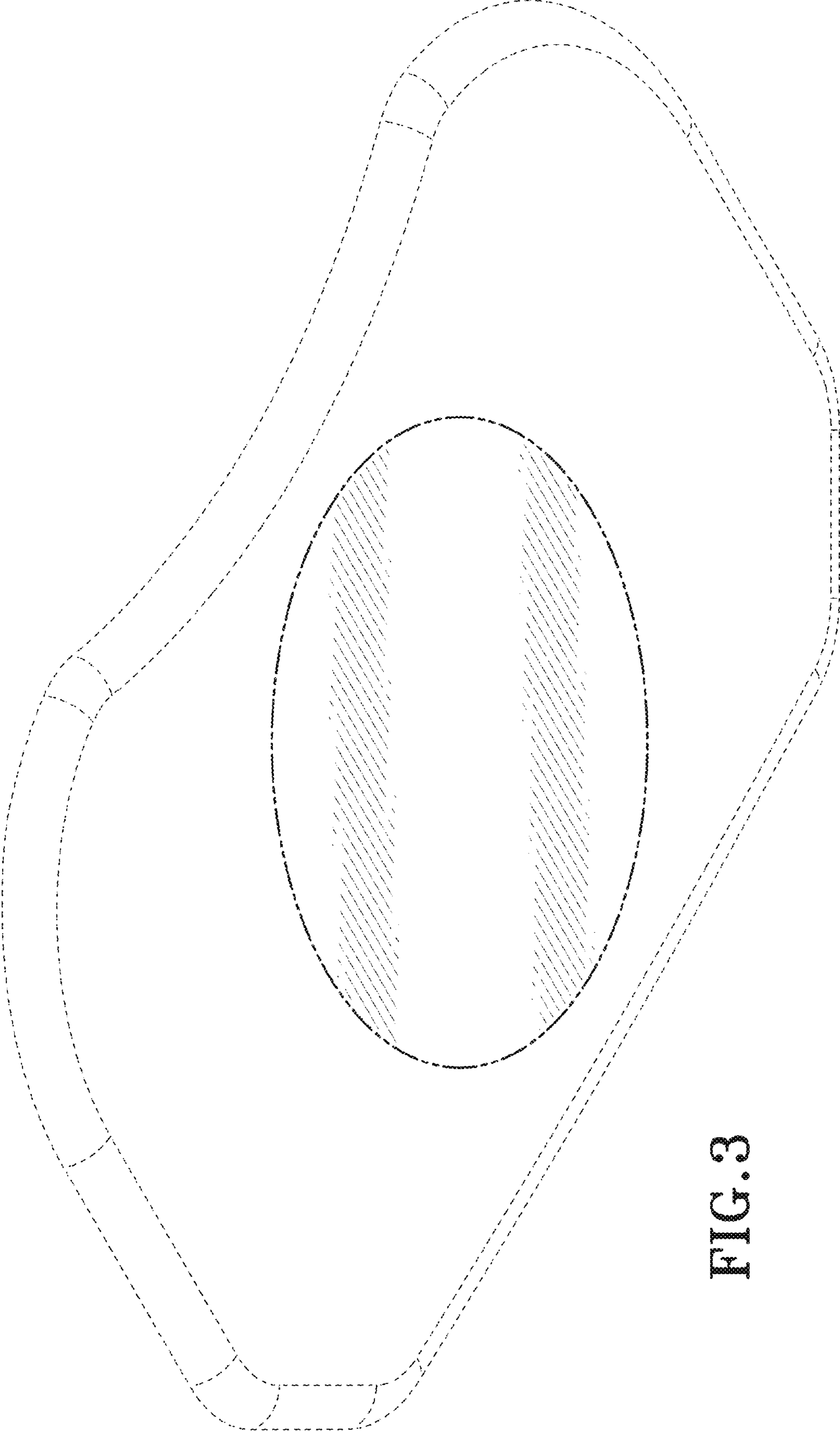

FIG. 3

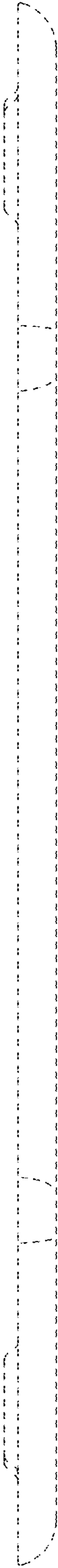

FIG. 4

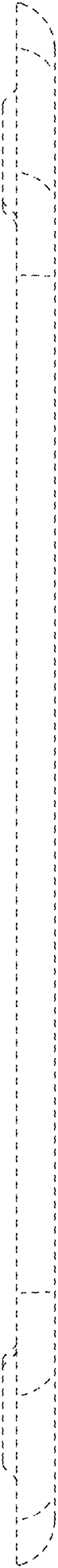

FIG. 5

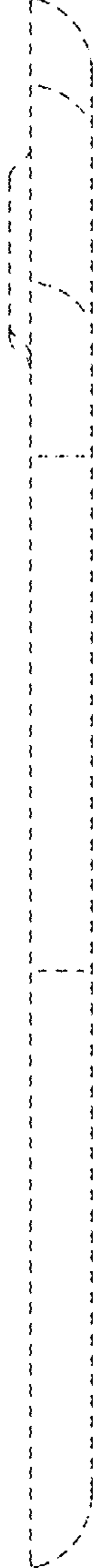

FIG. 6

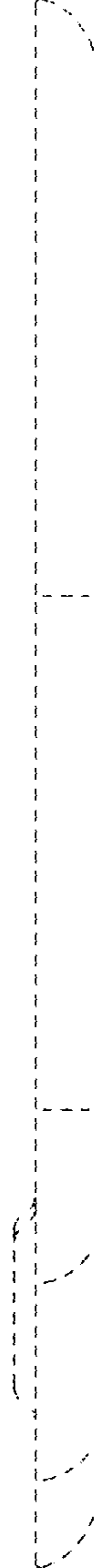

FIG. 7

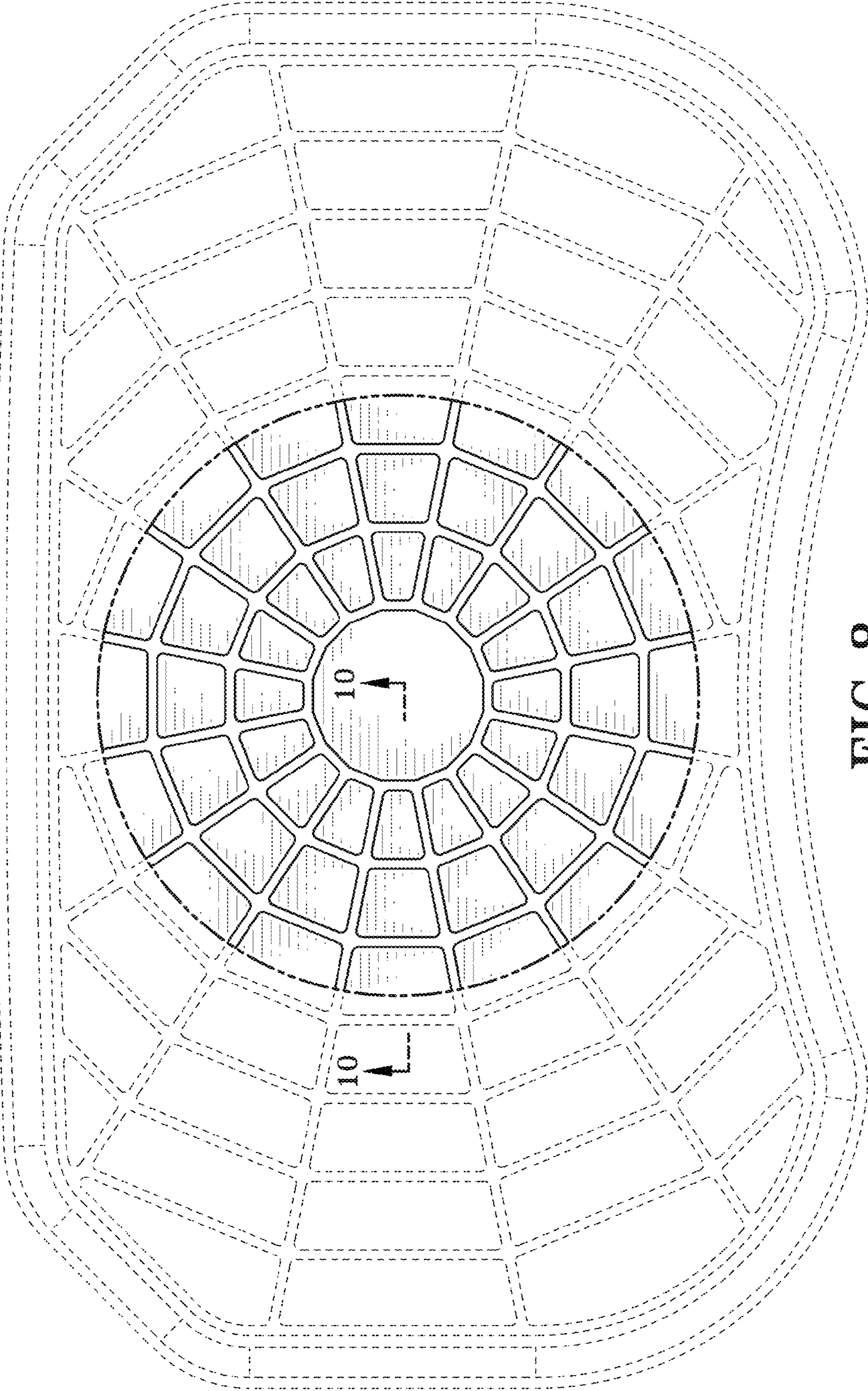

FIG. 8

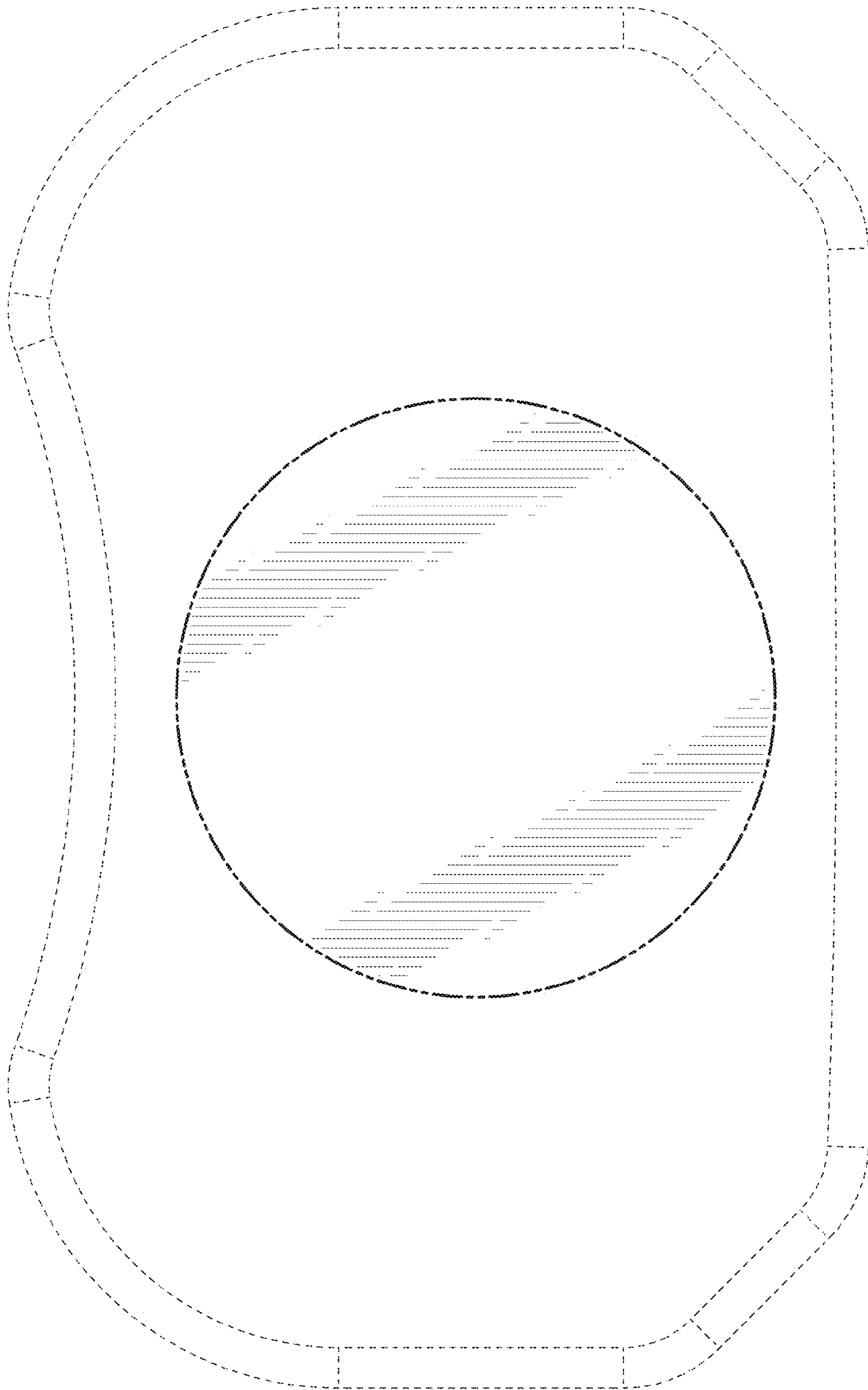

FIG. 9

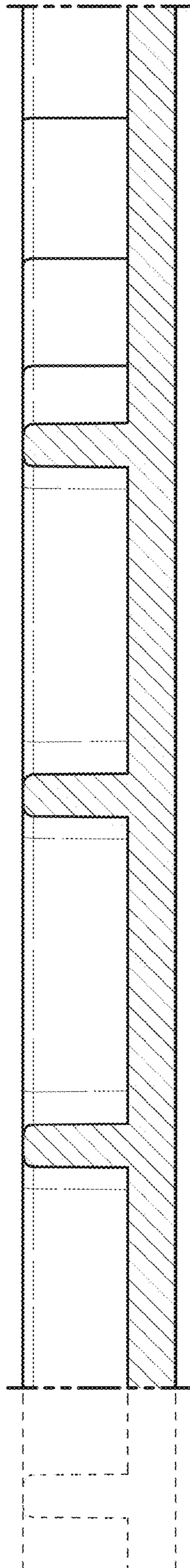

FIG. 10