



US00D981052S

(12) **United States Design Patent**
Becattini, Jr. et al.

(10) **Patent No.:** **US D981,052 S**
(45) **Date of Patent:** **** Mar. 14, 2023**

(54) **FEEDING MAT**

(71) Applicant: **Towerstar Pets, LLC**, Malvern, PA
(US)

(72) Inventors: **Fernando Becattini, Jr.**, Malvern, PA
(US); **Jacquelyn N. Becattini**, Malvern,
PA (US); **Steve A. Copeland**, Barrie
(CA)

(73) Assignee: **Towerstar Pets, LLC**, Malvern, PA
(US)

(**) Term: **15 Years**

(21) Appl. No.: **29/754,897**

(22) Filed: **Oct. 15, 2020**

(51) **LOC (14) Cl.** **30-07**

(52) **U.S. Cl.**
USPC **D30/121; D30/199**

(58) **Field of Classification Search**
USPC D30/121, 122, 129-133, 199; 119/51.01,
119/51.02, 51.03, 51.11, 51.15, 51.5, 70,
119/52.1, 52.3, 52.4, 53, 53.5, 54, 57.92,
119/61.1, 61.3, 61.5, 61, 52, 61.53, 61.54,
119/61.55, 68, 72, 73, 74, 75, 78, 174
(Continued)

(56) **References Cited**

U.S. PATENT DOCUMENTS

8,534,225 B2 9/2013 Vermeegen
D709,247 S 7/2014 Gailen
(Continued)

FOREIGN PATENT DOCUMENTS

WO 20190188 1/2019

OTHER PUBLICATIONS

“Mighty Paw Dog Lick Pad” available Oct. 28, 2020, [online], [site visited Sep. 26, 2022]. Retrieved from Internet, URL:https://www.

amazon.com/Mighty-Paw-BPA-Free-Silicone-Dishwasher/dp/B08M3ZRL7V?th=1 (Year: 2020).*

(Continued)

Primary Examiner — Katrina N Gonzalez
(74) *Attorney, Agent, or Firm* — Sand, Sebolt & Wernow
Co., LPA

(57) **CLAIM**

The ornamental design for a feeding mat, as shown.

DESCRIPTION

FIG. 1 is a top left front perspective view of a feeding mat in accordance with our design.
FIG. 2 is a top right front perspective view of a feeding mat in accordance with our design.
FIG. 3 is a bottom left front perspective view of a feeding mat in accordance with our design.
FIG. 4 is a front elevation plan view of a feeding mat in accordance with our design.
FIG. 5 is a rear elevation plan view of a feeding mat in accordance with our design.
FIG. 6 is a right side elevation plan view of a feeding mat in accordance with our design.
FIG. 7 is a left side elevation plan view of a feeding mat in accordance with our design.
FIG. 8 is a top plan view of a feeding mat in accordance with our design.
FIG. 9 is a bottom plan view of a feeding mat in accordance with our design; and,
FIG. 10 is a cross-sectional front view of a feeding mat taken along and in the direction of line 10-10 in FIG. 8 in accordance with our design.
The broken lines in FIG. 8 represent a cross section marker. The broken lines in FIG. 10 represent the bounds of the view. The broken lines form no part of the claimed design.

1 Claim, 7 Drawing Sheets

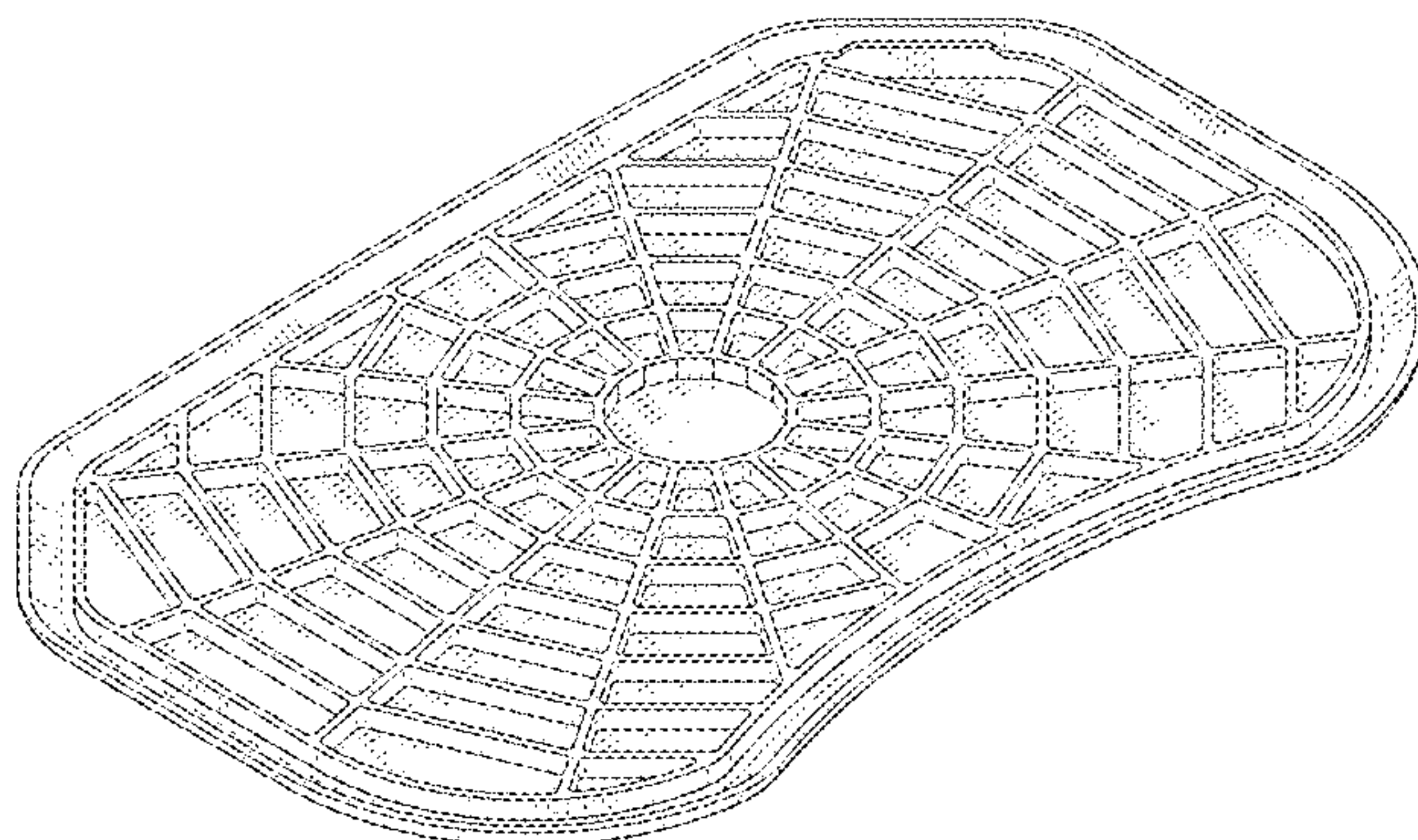

(58) **Field of Classification Search**

CPC . A01K 5/00; A01K 7/00; A01K 39/02; A01K 39/04; A01K 39/0213; A01K 5/0121; A01K 5/0135; A01K 7/005

See application file for complete search history.

D937,500 S * 11/2021 Wu D30/121
2017/0071155 A1 3/2017 Gailen et al.
2020/0196566 A1 6/2020 Clarke et al.

(56) **References Cited**

U.S. PATENT DOCUMENTS

8,844,466 B2 9/2014 Vermeegan
D725,317 S 3/2015 Avalos Sartorio et al.
D727,576 S 4/2015 Avalos Sartorio et al.
D749,274 S 2/2016 Gailen
D751,773 S 3/2016 Gailen
D912,913 S * 3/2021 Wendling D30/161
D914,996 S * 3/2021 Xie D30/121
D915,686 S 4/2021 Becattini, Jr. et al.
D926,395 S * 7/2021 Mei D30/161
D927,795 S * 8/2021 Clarke D30/121
D927,796 S * 8/2021 Clarke D30/121
D929,679 S * 8/2021 Elliott D30/161

OTHER PUBLICATIONS

“8 Tasty Treat Suggestions for the Neat-Lik Mat” available Aug. 11, 2021, [online], [site visited Sep. 26, 2022]. Retrieved from Internet, URL:<https://neaterpets.com/blogs/news/neat-lik-mat-treat-suggestions> (Year: 2021).*

“Neater Pets Walmart” available Jul. 12, 2021, [online], [site visited Sep. 26, 2022]. Retrieved from Internet, URL:<https://www.walmart.com/reviews/product/858122977?sort=submission-asc> (Year: 2021).*

“Neater Pets Facebook” available Jul. 14, 2021, [online], [site visited Sep. 26, 2022]. Retrieved from Internet, URL:[facebook.com/NeaterPets/photos/3001198126794819](https://www.facebook.com/NeaterPets/photos/3001198126794819) (Year: 2021).*

“Neater Pets Amazon” available Nov. 20, 2020, [online], [site visited Sep. 26, 2022]. Retrieved from Internet, URL:<https://www.amazon.com/Neater-Pets-Neat-LIK-Feeding-Provide/dp/B08NXT5FRL?tag=rovetrx544-20> (Year: 2020).*

* cited by examiner

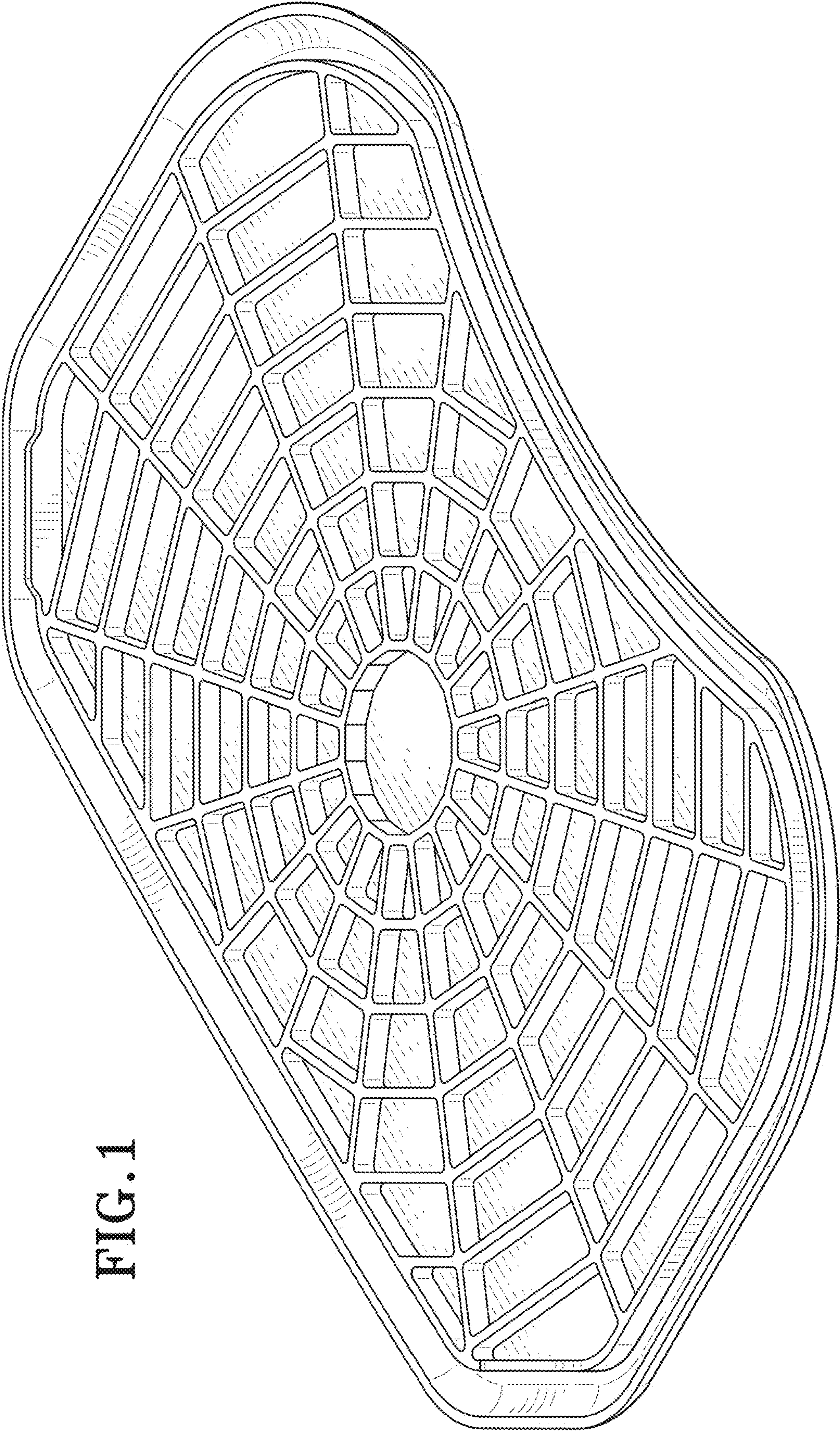
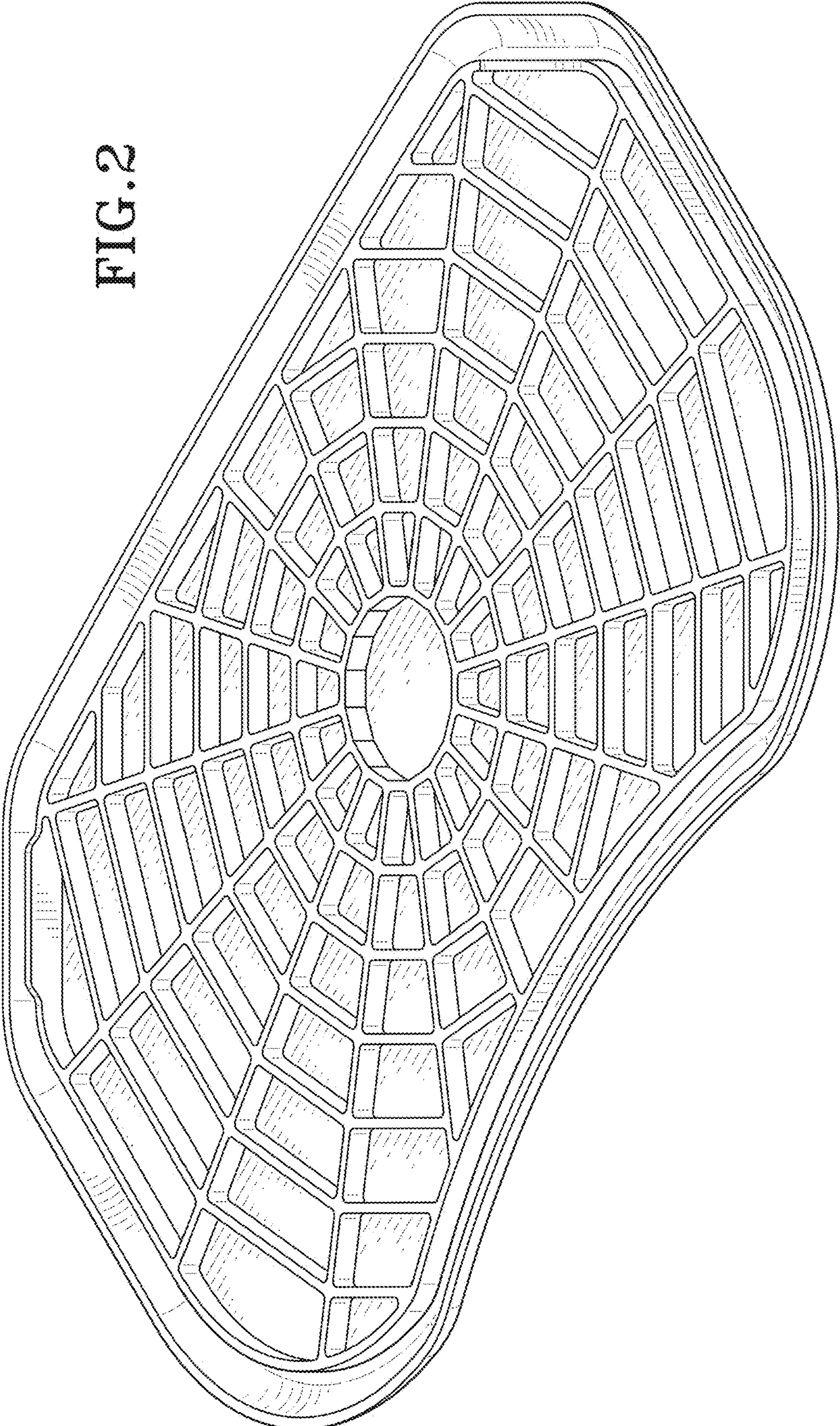

FIG. 1

FIG. 2



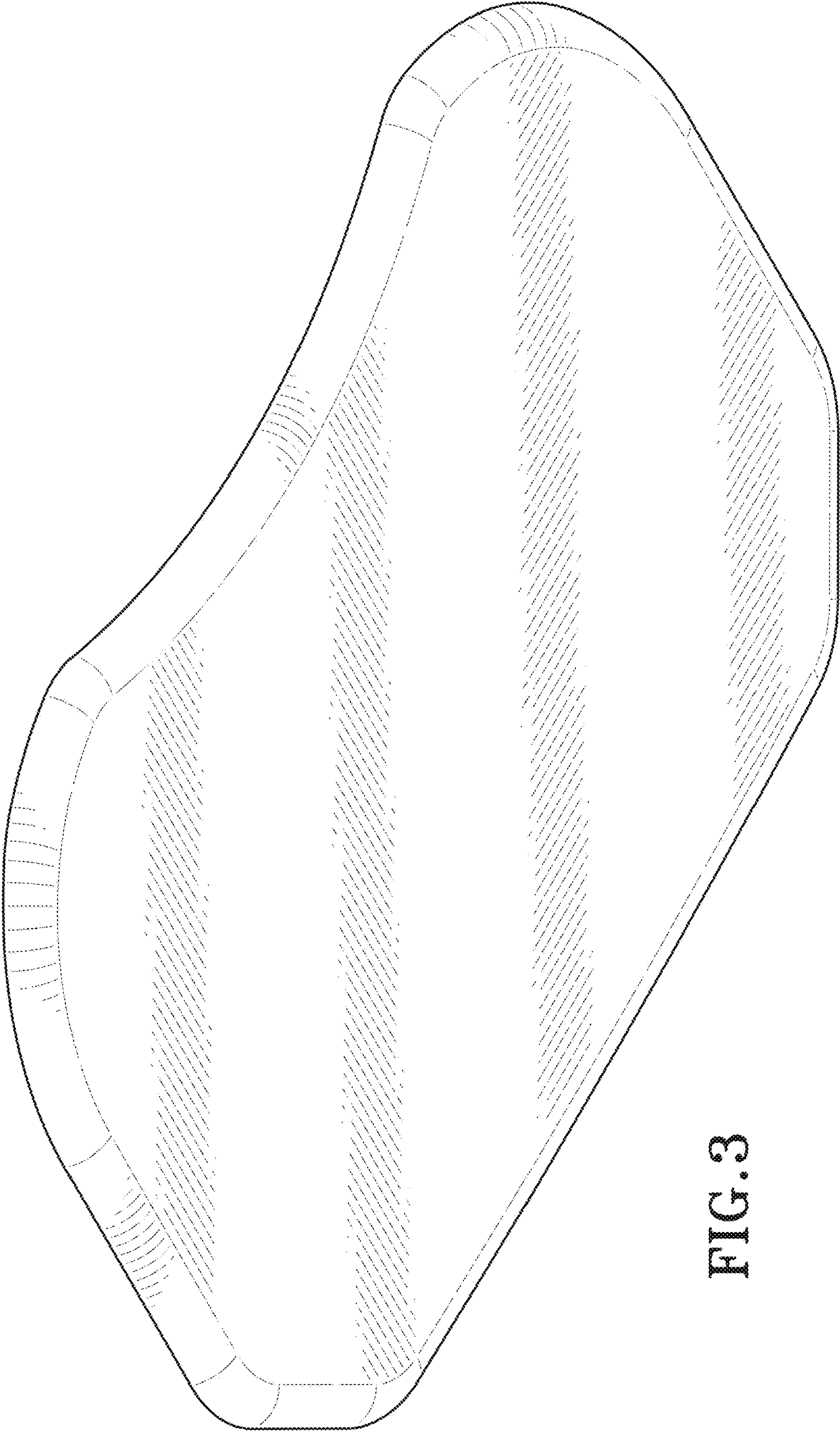

FIG. 3

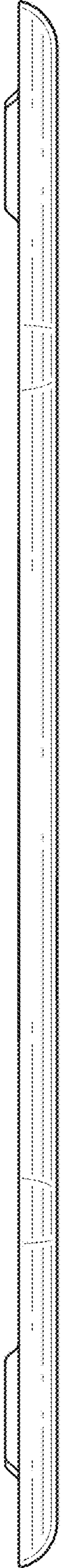

FIG. 4

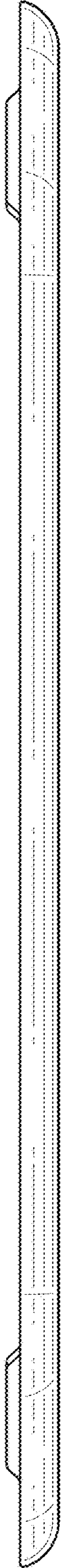

FIG. 5

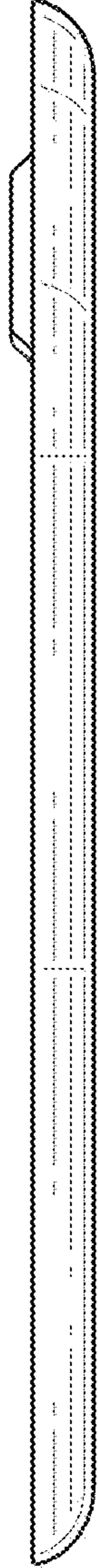

FIG. 6

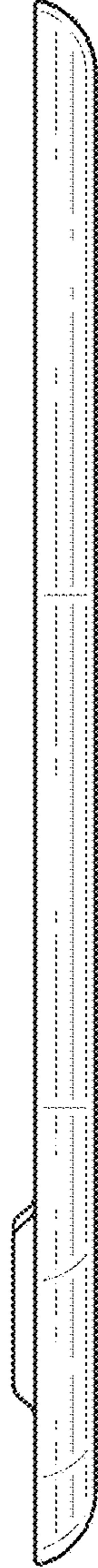

FIG. 7

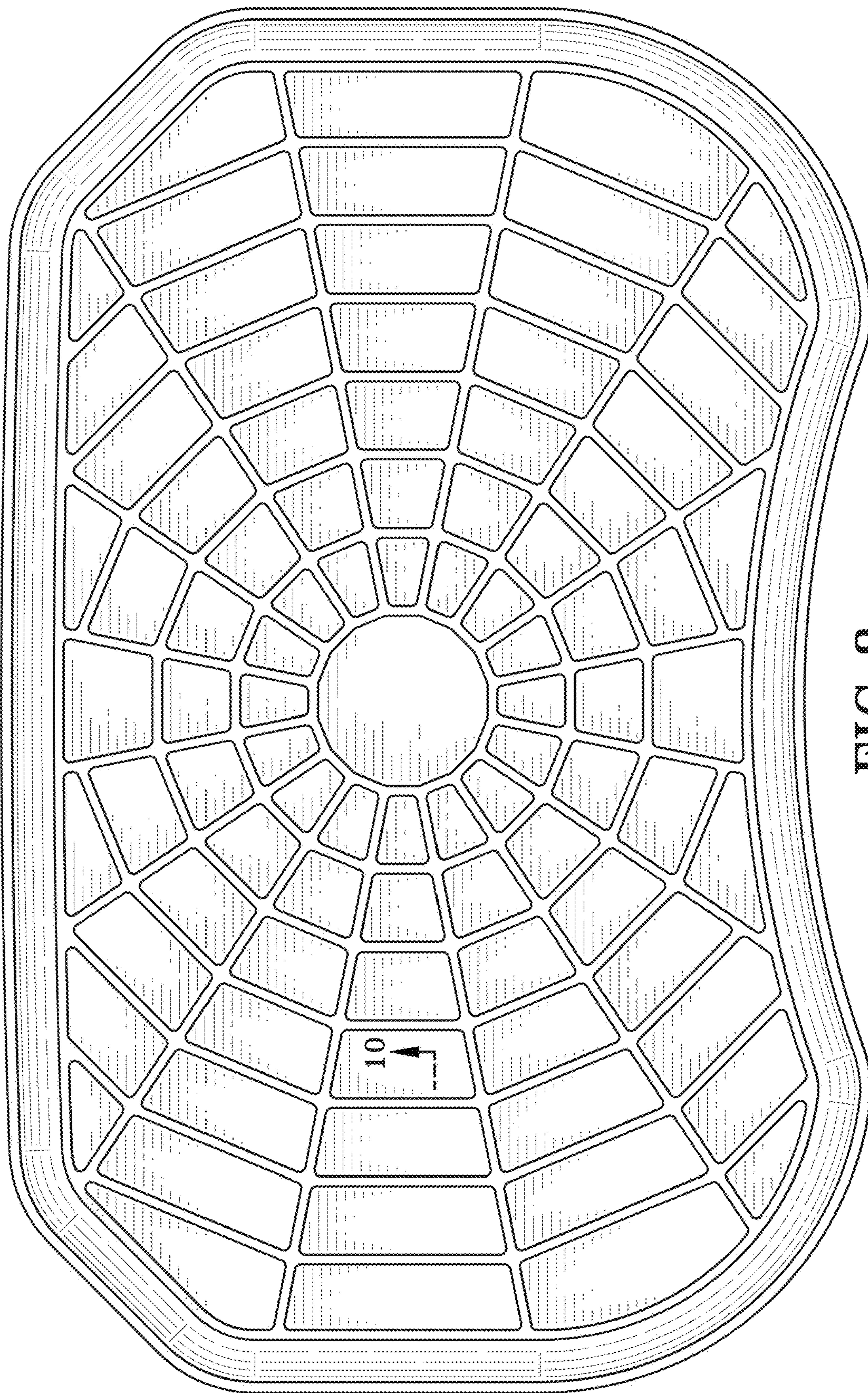

FIG. 8

10

10

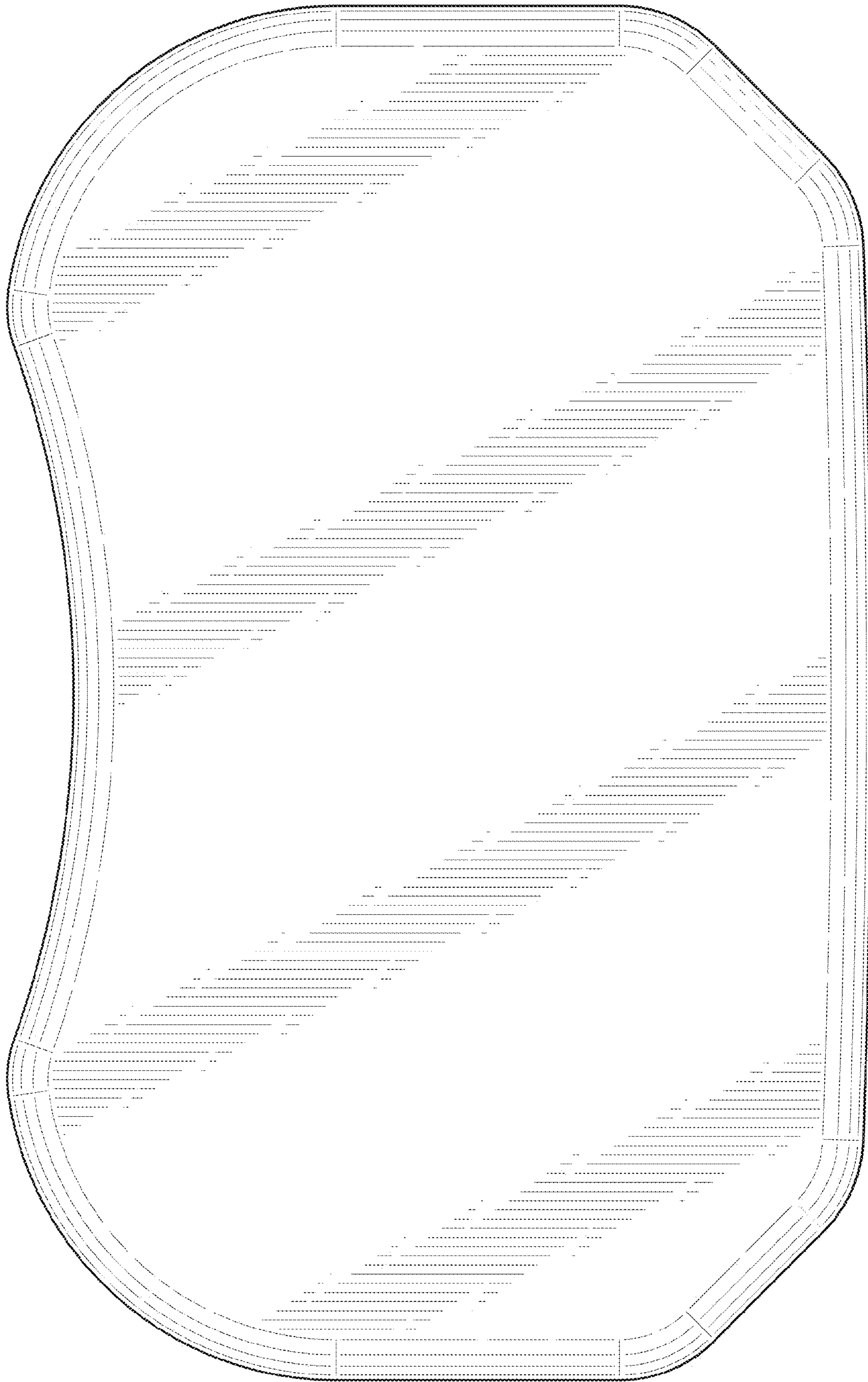

FIG. 9

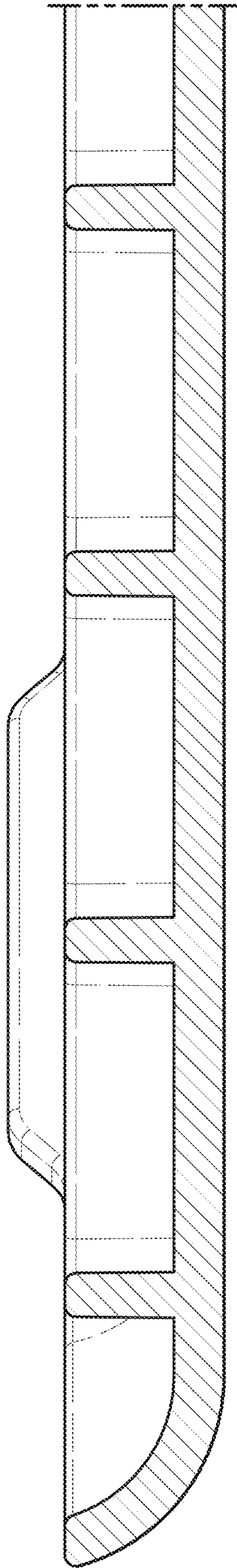

FIG. 10