



US00D981045S

(12) **United States Design Patent** (10) **Patent No.:** **US D981,045 S**
Goeder et al. (45) **Date of Patent:** **** Mar. 14, 2023**

(54) **ELECTRIC DRY SHAVER HEAD**
(71) Applicant: **Braun GmbH**, Kronberg (DE)
(72) Inventors: **Philipp Goeder**, Frankfurt (DE);
Gregor Ptok, Frankfurt (DE);
Bernhard Sikora, Kelkheim (DE);
Wolfgang Stegmann, Frankfurt (DE)
(73) Assignee: **Braun GMBH**, Kronberg (DE)
(**) Term: **15 Years**
(21) Appl. No.: **29/781,617**
(22) Filed: **Apr. 30, 2021**

Related U.S. Application Data

(62) Division of application No. 29/709,111, filed on Oct. 11, 2019, now Pat. No. Des. 921,985, which is a division of application No. 29/598,471, filed on Mar. 27, 2017, now Pat. No. Des. 868,377.

Foreign Application Priority Data

Sep. 28, 2016 (WO) 968861101
Nov. 10, 2016 (WO) 1336501

(51) **LOC (14) Cl.** **28-03**

(52) **U.S. Cl.**
USPC **D28/54**

(58) **Field of Classification Search**
USPC D28/49-54
CPC B26B 19/38-3813; B26B 19/3826; B26B 19/3846; B26B 19/386; B26B 19/06-08; B26B 19/10; B26B 19/04-048; B26B 19/48

See application file for complete search history.

(56) **References Cited**
U.S. PATENT DOCUMENTS
D356,185 S 3/1995 Rizzuto
D454,980 S 3/2002 Long et al.
D513,344 S 12/2005 Choi
D513,541 S * 1/2006 Nishizawa D28/49
D518,236 S 3/2006 Butcher
7,065,879 B2 6/2006 Bader et al.
D567,446 S 4/2008 Hara et al.
D571,957 S * 6/2008 Nishizawa D28/51
D586,955 S 2/2009 Eigenstetter et al.
D590,542 S * 4/2009 Ullmann D28/49
D590,543 S * 4/2009 Ullmann D28/49
(Continued)

FOREIGN PATENT DOCUMENTS

CN 110340948 A * 10/2019
CN 110340948 A 10/2019
(Continued)

OTHER PUBLICATIONS

All Office Actions; U.S. Appl. No. 29/598,471, filed Mar. 27, 2017.
(Continued)

Primary Examiner — Jennifer Rivard
(74) *Attorney, Agent, or Firm* — Kevin C. Johnson

(57) **CLAIM**
The ornamental design for an electric dry shaver head, as shown and described.

DESCRIPTION

FIG. 1 is a perspective view of an electric dry shaver head; FIG. 2 is a front view thereof; FIG. 3 is a right side view thereof; FIG. 4 is a rear view thereof; FIG. 5 is a left side view thereof; FIG. 6 is a top plan view thereof; and, FIG. 7 is a bottom view thereof.

1 Claim, 1 Drawing Sheet

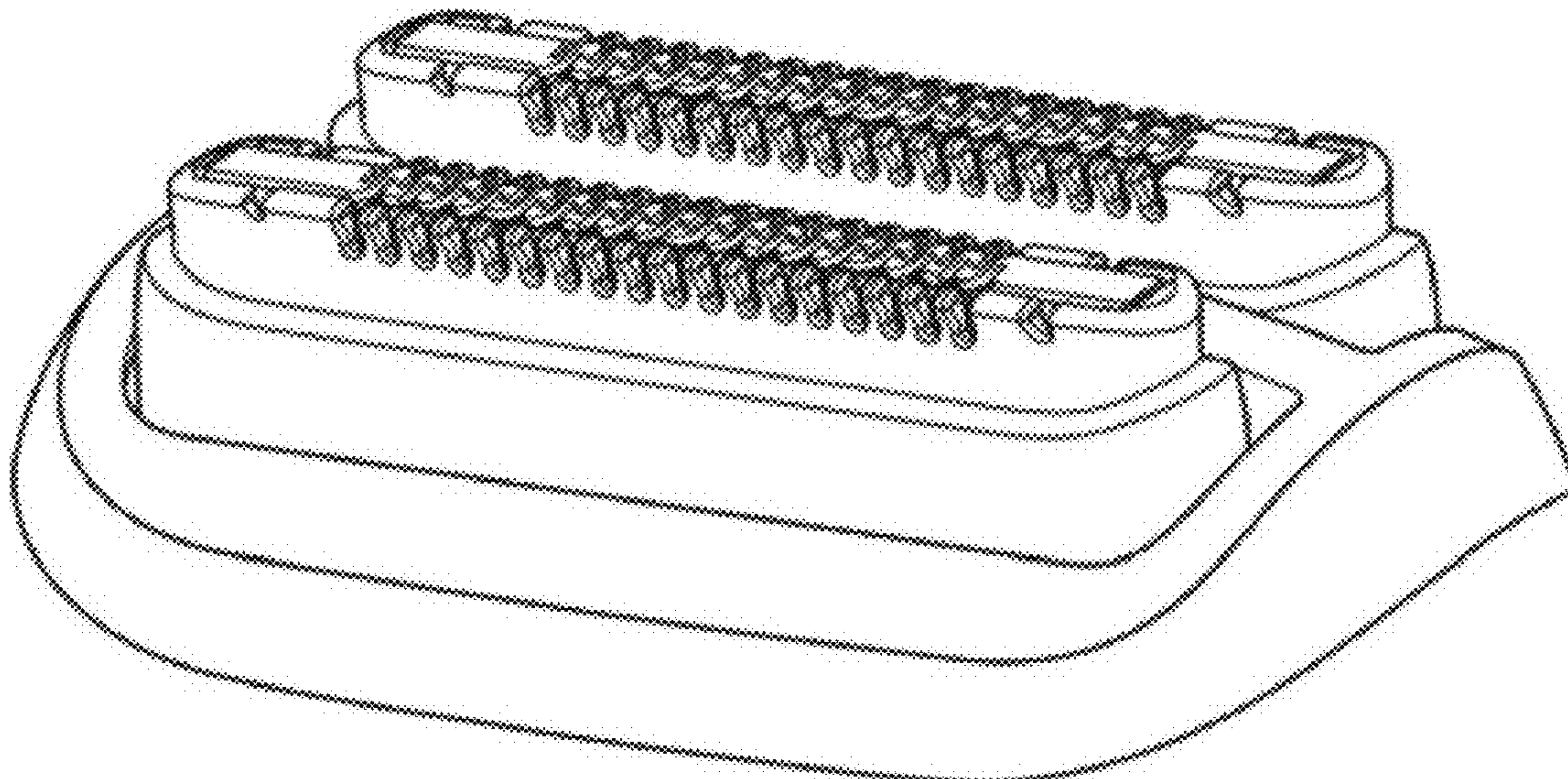

(56)

References Cited

U.S. PATENT DOCUMENTS

D604,907 S 11/2009 Emminger
 D628,745 S 12/2010 Dingelstad
 D648,895 S 11/2011 Ino
 D649,290 S 11/2011 Ino
 D657,912 S 4/2012 Yoon
 D664,298 S * 7/2012 Grabes D28/54
 D668,387 S * 10/2012 Grabes D28/51
 D675,377 S 1/2013 Boulanger
 D689,242 S * 9/2013 Grabes D28/54
 D690,880 S 10/2013 Grabes et al.
 D696,458 S 12/2013 Ino
 D698,084 S 1/2014 Yoon
 D698,492 S 1/2014 Grabes et al.
 D702,882 S * 4/2014 Grabes D28/51
 D711,594 S 8/2014 Palmer et al.
 D713,994 S * 9/2014 Grabes D28/54
 D717,001 S 11/2014 Uematsu
 D717,996 S 11/2014 Kikuchi
 D722,199 S 2/2015 Boulanger
 D724,271 S 3/2015 Giannini
 D733,358 S 6/2015 Palmer et al.
 D751,252 S * 3/2016 Grabes D28/51
 D752,811 S 3/2016 Okabe et al.
 D753,342 S 4/2016 Okabe
 D756,565 S 5/2016 Andersson
 D758,018 S * 5/2016 Okabe D28/54
 D760,437 S 6/2016 Emminger
 D763,509 S 8/2016 Teteak et al.
 D767,207 S 9/2016 Dekliein
 D768,391 S 10/2016 Kling et al.
 D771,315 S 11/2016 Andersson et al.
 D781,588 S 3/2017 Lee
 D784,618 S 4/2017 Mori et al.
 D799,118 S 10/2017 Ino
 D800,965 S 10/2017 Aulwes et al.
 D802,214 S 11/2017 Mintz et al.
 D804,189 S 12/2017 Von Berg
 D813,457 S 3/2018 Okabe et al.
 D813,458 S 3/2018 Okabe et al.
 9,962,842 B2 5/2018 Komori et al.
 D819,338 S 6/2018 Xiong
 10,080,428 B2 9/2018 Kern
 D829,445 S 10/2018 Kern
 D851,835 S 6/2019 Gross
 D853,648 S 7/2019 Boulanger et al.
 10,421,202 B2 9/2019 Erndt et al.
 D866,072 S 11/2019 Chen
 D866,861 S 11/2019 Dawson et al.
 D867,663 S 11/2019 Boulanger
 D868,377 S 11/2019 Goeder et al.
 10,486,316 B2 11/2019 Erndt et al.
 10,486,318 B2 11/2019 Bady et al.
 D872,366 S 1/2020 Cociffi et al.
 10,532,473 B2 1/2020 Krauss et al.
 10,556,354 B2 2/2020 Erndt et al.
 D879,377 S 3/2020 Dawson et al.
 D883,573 S 5/2020 Cociffi et al.
 10,702,999 B2 7/2020 Iaccarino et al.
 10,751,893 B2 8/2020 Okura et al.
 D899,690 S 10/2020 De Belizal
 D905,909 S 12/2020 Wang
 D908,962 S 1/2021 Tran
 10,906,195 B2 2/2021 Bady et al.
 D921,985 S * 6/2021 Goeder D28/51
 D922,682 S * 6/2021 Sikora D28/51
 D925,830 S * 7/2021 Szymanski D28/54
 D930,245 S 9/2021 De Belizal
 D940,958 S * 1/2022 Langberg D28/54
 D942,082 S 1/2022 Goeder et al.
 D942,083 S 1/2022 Goeder et al.
 D942,686 S 2/2022 Goeder et al.
 D961,160 S * 8/2022 Sikora D28/51
 D965,889 S 10/2022 Zeng
 2006/0010630 A1 1/2006 Tse

2008/0134514 A1 * 6/2008 Iwasaki B26B 19/10
 30/43.91
 2009/0133264 A1 * 5/2009 Eichhorn B26B 19/105
 30/45
 2012/0192436 A1 8/2012 Toy
 2013/0023806 A1 1/2013 Ungemach et al.
 2013/0097871 A1 4/2013 Yamaguchi et al.
 2015/0314461 A1 11/2015 Man Wong et al.
 2016/0031099 A1 2/2016 Provolo et al.
 2016/0176058 A1 6/2016 Piesker et al.
 2017/0190063 A1 7/2017 Schratte et al.
 2018/0085934 A1 * 3/2018 Erndt B26B 19/40
 2018/0085937 A1 * 3/2018 Erndt B26B 19/3846
 2018/0085940 A1 3/2018 Krauss et al.
 2018/0085945 A1 3/2018 Bady et al.
 2018/0085949 A1 * 3/2018 Krauss B26B 19/28
 2018/0085956 A1 * 3/2018 Bady B26B 19/42
 2018/0092449 A1 4/2018 Straka et al.
 2018/0311842 A1 11/2018 Kraus et al.
 2018/0319026 A1 11/2018 Hayashi et al.
 2019/0299433 A1 10/2019 Fuerst et al.
 2019/0299438 A1 10/2019 Erndt
 2021/0031386 A1 * 2/2021 Neyer B26B 19/382
 2021/0268674 A1 9/2021 Weschta et al.

FOREIGN PATENT DOCUMENTS

CN 112873285 A 6/2021
 CN 215282036 U * 12/2021
 CN 215282036 U 12/2021
 WO 2016041959 A1 3/2016
 WO WO-2016041959 A1 * 3/2016 B26B 19/04

OTHER PUBLICATIONS

All Office Actions; U.S. Appl. No. 29/709,111, filed Oct. 11, 2019.
 All Office Actions; U.S. Appl. No. 29/781,553, filed Apr. 30, 2021.
 All Office Actions; U.S. Appl. No. 29/781,558, filed Apr. 30, 2021.
 All Office Actions; U.S. Appl. No. 29/781,564, filed Apr. 30, 2021.
 All Office Actions; U.S. Appl. No. 29/781,600, filed Apr. 30, 2021.
 All Office Actions; U.S. Appl. No. 29/781,606, filed Apr. 30, 2021.
 All Office Actions; U.S. Appl. No. 29/781,610, filed Apr. 30, 2021.
 All Office Actions; U.S. Appl. No. 29/781,624, filed Apr. 30, 2021.
 All Office Actions; U.S. Appl. No. 29/781,627, filed Apr. 30, 2021.
 All Office Actions; U.S. Appl. No. 29/781,635, filed Apr. 30, 2021.
 All Office Actions; U.S. Appl. No. 29/781,642, filed on U.S. Appl. No. 29/781,642.
 All Office Actions; U.S. Appl. No. 29/781,651, filed Apr. 30, 2021.
 All Office Actions; U.S. Appl. No. 29/781,656, filed Apr. 30, 2021.
 All Office Actions; U.S. Appl. No. 29/781,663, filed Apr. 30, 2021.
 All Office Actions; U.S. Appl. No. 29/781,627, filed Apr. 30, 2021.
 URL Link: <https://www.amazon.com/Braun-Trimmer-Cordless-Rechargeable-Clipper/dp/B07XZS N2N3?th=1Braun Beard Trimmer BT3221>, reviewed as early as May 2020, 1 page (Year: 2020).
 Kemei Dry Shaver Brush, www.cdn.shopify.com, 1 page, downloaded Dec. 2018 (Year: 2018).
 Philips Series 7000, www.philips.co.uk, 1 page, downloaded Dec. 2018 (Year: 2018).
 U.S. Appl. No. 29/781,651, filed Apr. 30, 2021, Philipp Goeder et al.
 U.S. Appl. No. 29/781,656, filed Apr. 30, 2021, Philipp Goeder et al.
 U.S. Appl. No. 29/781,663, filed Apr. 30, 2021, Philipp Goeder et al.
 U.S. Appl. No. 29/781,558, filed Apr. 30, 2021, Philipp Goeder et al.
 U.S. Appl. No. 29/781,564, filed Apr. 30, 2021, Philipp Goeder et al.
 U.S. Appl. No. 29/781,600, filed Apr. 30, 2021, Philipp Goeder et al.
 U.S. Appl. No. 29/781,606, filed Apr. 30, 2021, Philipp Goeder et al.
 U.S. Appl. No. 29/781,610, filed Apr. 30, 2021, Philipp Goeder et al.

(56)

References Cited

OTHER PUBLICATIONS

U.S. Appl. No. 29/781,624, filed Apr. 30, 2021, Philipp Goeder et al.

U.S. Appl. No. 29/781,553, filed Apr. 30, 2021, Philipp Goeder et al.

* cited by examiner

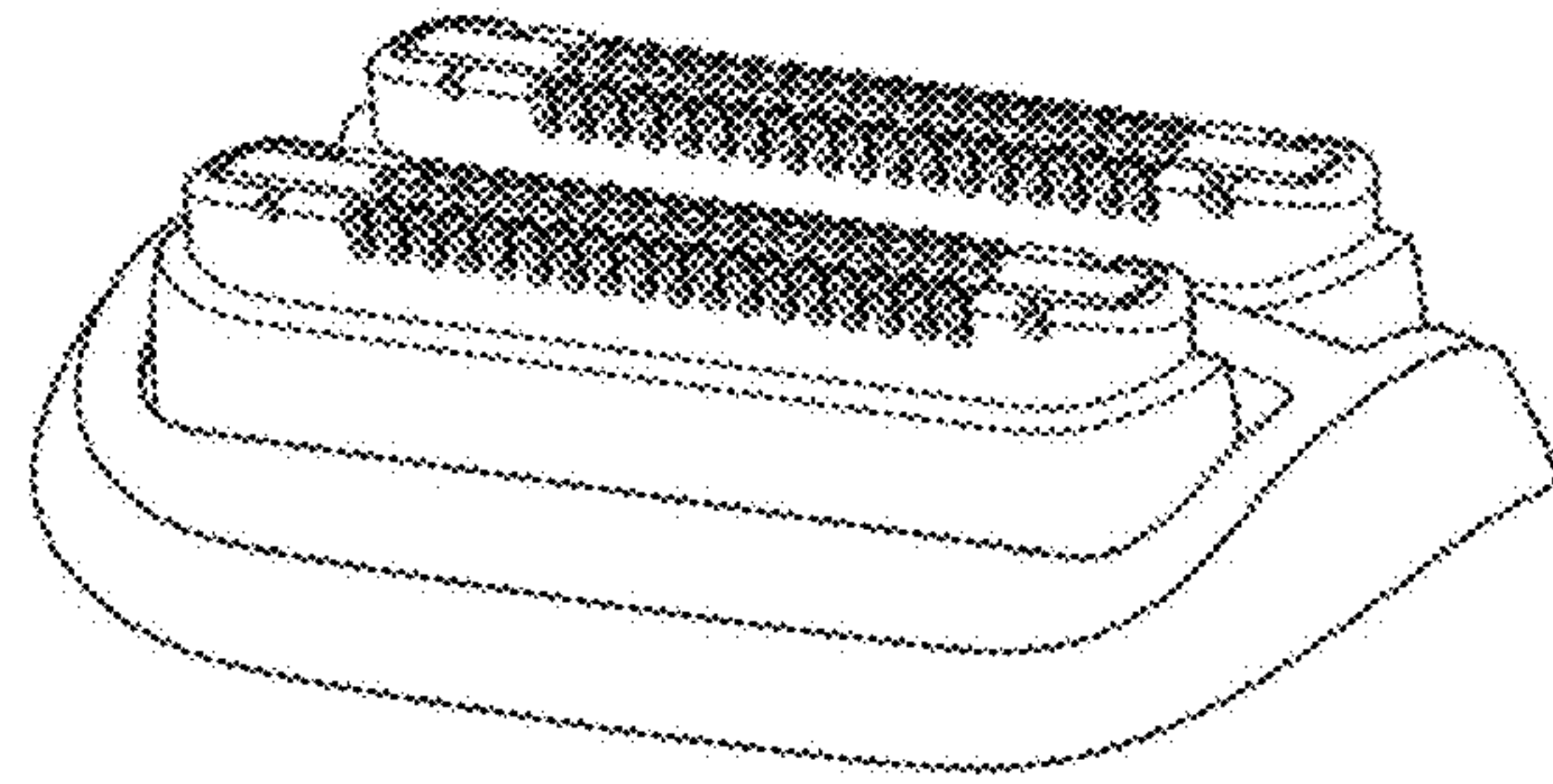

Fig. 1

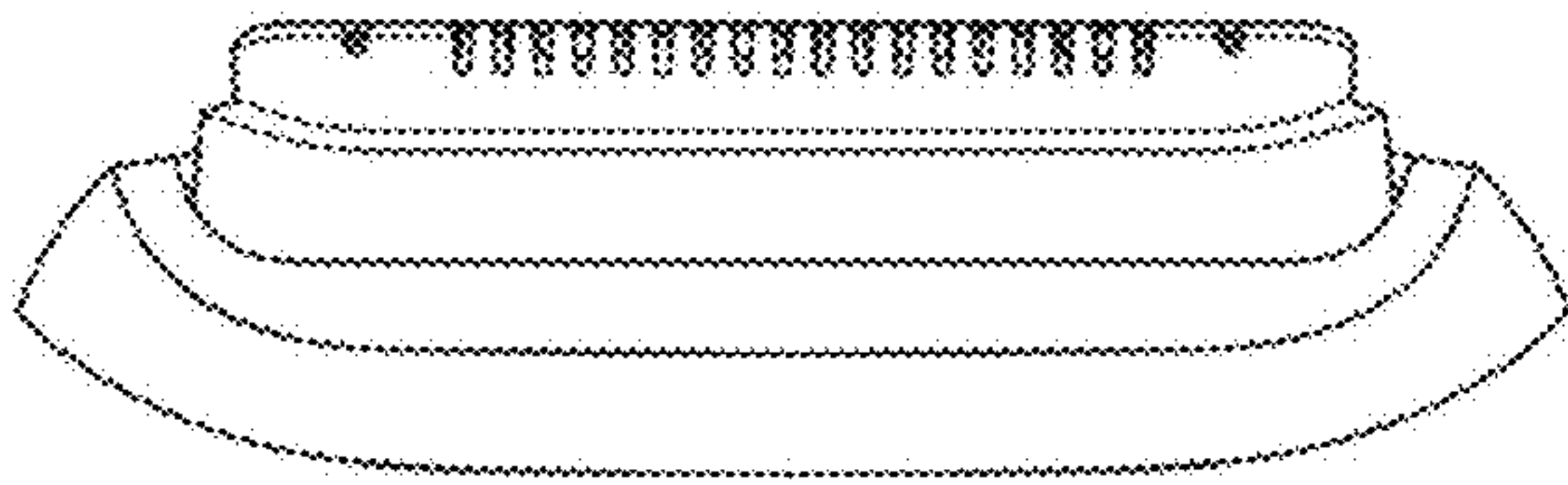

Fig. 2

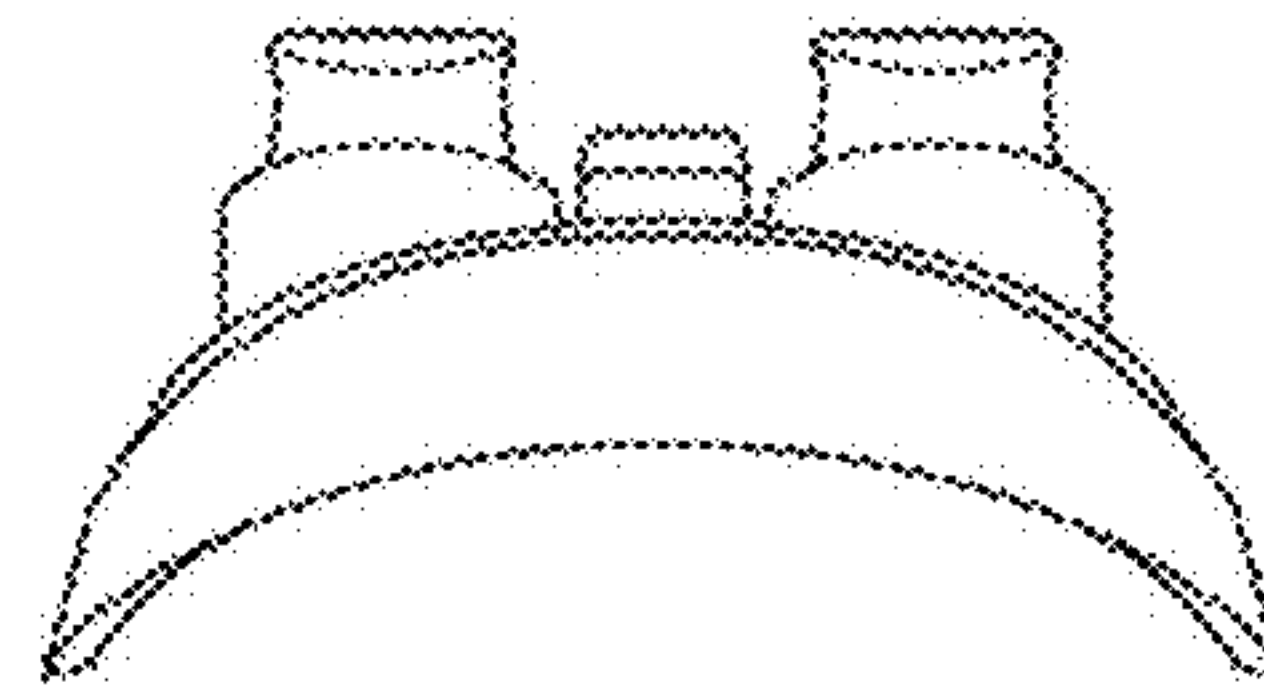

Fig. 3

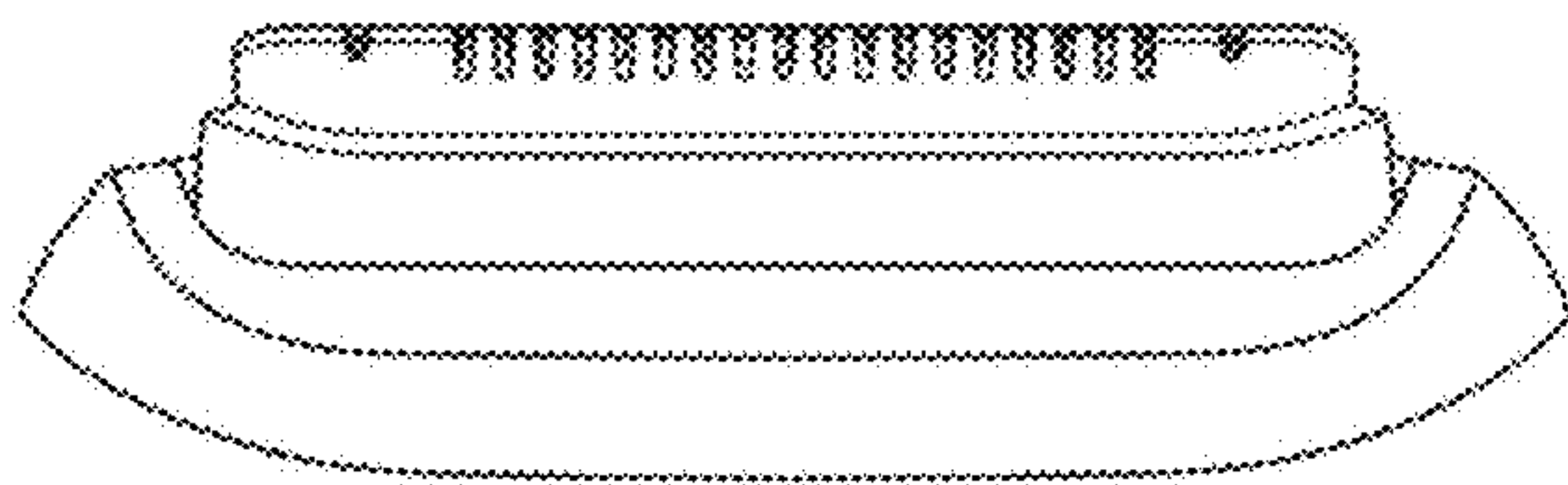

Fig. 4

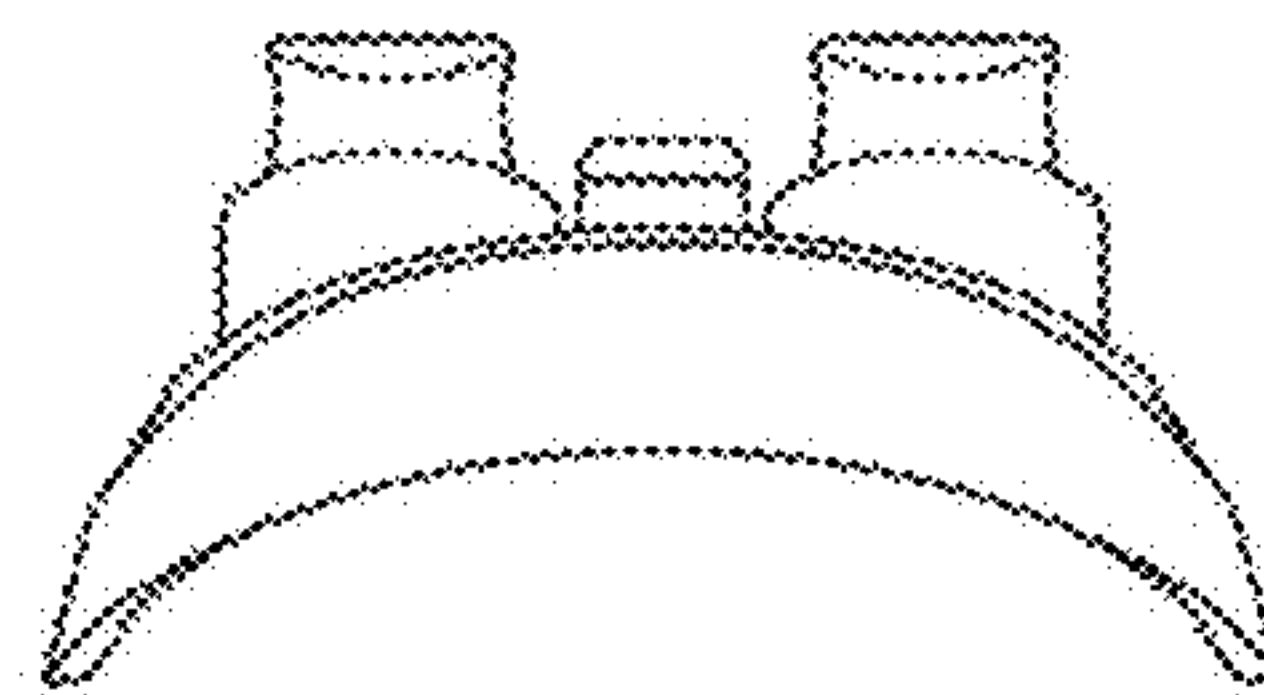

Fig. 5

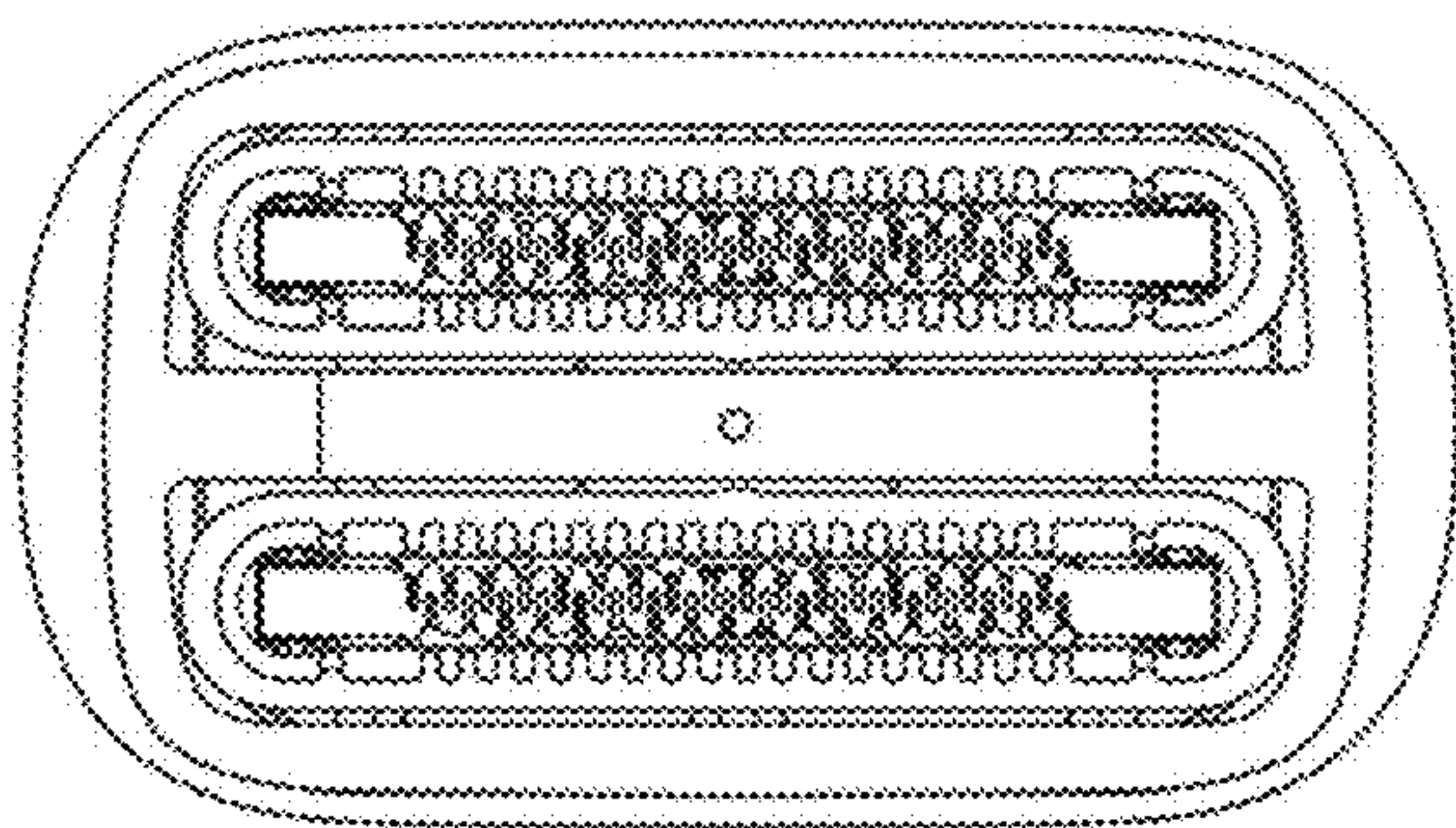

Fig. 6

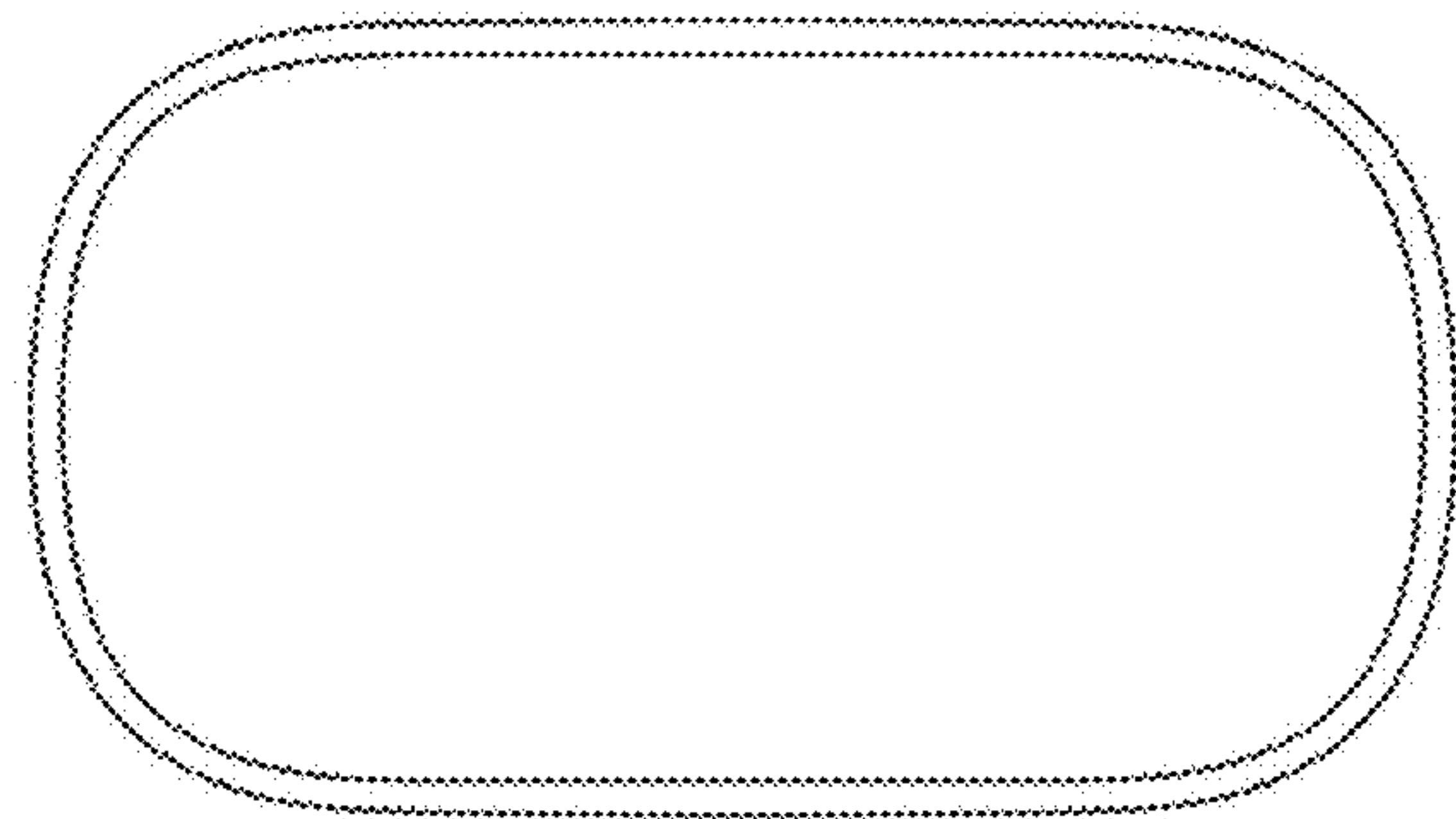

Fig. 7