



US00D980972S

(12) **United States Design Patent** (10) **Patent No.:** **US D980,972 S**
Zarins et al. (45) **Date of Patent:** **** Mar. 14, 2023**

(54) **DISTAL EXTENSION FOR A BLOOD PUMP SYSTEM**

peripheral-intervention/angiography/diagnostic-peripheral-catheters/performa-vessel-sizing-catheters/ (Year: 2022).*

(Continued)

(71) Applicant: **ABIOMED, Inc.**, Danvers, MA (US)

Primary Examiner — Natasha Vujcic

(72) Inventors: **Christopher Zarins**, Danvers, MA (US); **Alexander Ship**, Danvers, MA (US); **Zhenghong Tao**, Danvers, MA (US)

Assistant Examiner — Gilbert B Ford

(74) *Attorney, Agent, or Firm* — Botos Churchill IP Law LLP

(73) Assignee: **ABIOMED, INC.**, Danvers, MA (US)

(57) **CLAIM**

The ornamental design for a distal extension for a blood pump system, as shown and described.

(**) Term: **15 Years**

DESCRIPTION

(21) Appl. No.: **29/808,065**

(22) Filed: **Sep. 16, 2021**

(51) **LOC (14) Cl.** **24-02**

(52) **U.S. Cl.**
USPC **D24/112**

(58) **Field of Classification Search**
USPC D24/112–114, 133, 127–131, 140, 146,
D24/186, 108, 152, 156, 176

(Continued)

(56) **References Cited**

U.S. PATENT DOCUMENTS

3,965,909 A * 6/1976 Waddell B29C 63/18
604/269
4,898,577 A * 2/1990 Badger A61M 25/0152
604/95.04

(Continued)

FOREIGN PATENT DOCUMENTS

JP 2017515581 A 6/2017
KR 3010378970000 12/2019
TW D146687 4/2012

OTHER PUBLICATIONS

Performa® Vessel-Sizing Catheters, meritmedical, [Post date unknown],
[Site seen Oct. 26, 2022], seen at URL: <https://www.merit.com/>

FIG. 1 is a top, rear, right side perspective view of a distal extension for a blood pump system according to a first embodiment of our new design;
FIG. 2 is a right side elevation view thereof;
FIG. 3 is a left side elevation view thereof;
FIG. 4 is a rear side elevation view thereof;
FIG. 5 is a front side elevation view thereof;
FIG. 6 is a top plan view thereof;
FIG. 7 is a bottom plan view thereof;
FIG. 8 is a bottom, front, right side perspective view thereof;
FIG. 9 is a top, rear, right side perspective view of a second embodiment thereof;
FIG. 10 is a right side elevation view of FIG. 9;
FIG. 11 is a left side elevation view of FIG. 9;
FIG. 12 is a rear side elevation view of FIG. 9;
FIG. 13 is a front side elevation view of FIG. 9;
FIG. 14 is a top plan view of FIG. 9;
FIG. 15 is a bottom plan view of FIG. 9;
FIG. 16 is a top, rear, right side perspective view of a third embodiment thereof;
FIG. 17 is a right side elevation view of FIG. 16;
FIG. 18 is a left side elevation view of FIG. 16;
FIG. 19 is a rear side elevation view of FIG. 16;
FIG. 20 is a front side elevation view of FIG. 16;
FIG. 21 is a top plan view of FIG. 16; and,
FIG. 22 is a bottom plan view of FIG. 16.

The dot-dash broken lines represent boundaries of the claimed design and form no part thereof. All other broken

(Continued)

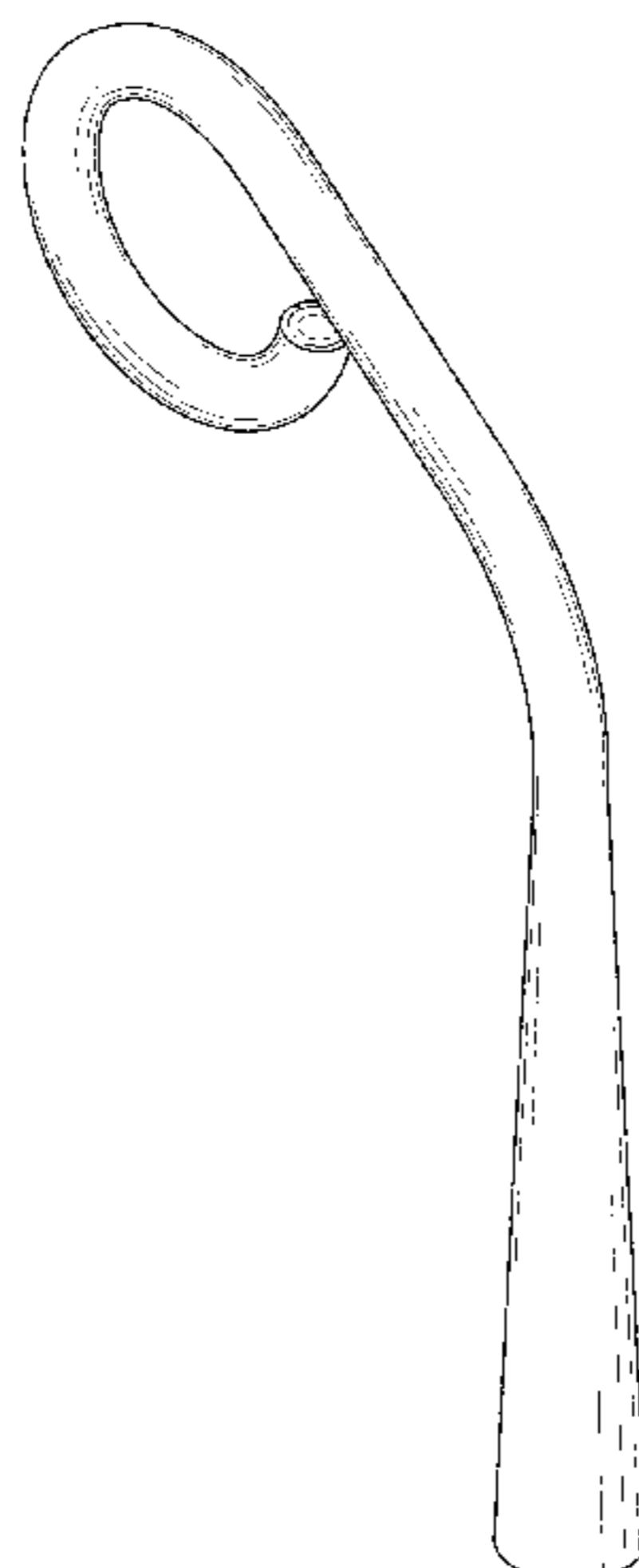

lines illustrate portions of the distal extension for a blood pump system that forms no part of the claimed design.

1 Claim, 16 Drawing Sheets

(58) **Field of Classification Search**

CPC A61M 25/0108; A61M 2025/09166; A61M 2025/0095; A61M 25/0102

See application file for complete search history.

(56) **References Cited**

U.S. PATENT DOCUMENTS

5,037,403 A * 8/1991 Garcia A61M 25/007
600/435
5,045,072 A * 9/1991 Castillo A61M 25/008
604/529
5,163,431 A * 11/1992 Griep A61M 25/0041
604/525
D340,111 S * 10/1993 Yoshikawa D24/129

5,300,048 A * 4/1994 Drewes, Jr. A61M 25/0108
604/529
5,957,911 A * 9/1999 Nesto A61M 25/0041
600/435
D460,555 S * 7/2002 Holbrook D24/156
D733,304 S * 6/2015 De Clerck D24/156
D748,257 S 1/2016 Franklin
D750,247 S * 2/2016 Cho D24/152
D751,200 S 3/2016 Larose et al.
9,656,042 B2 * 5/2017 Takagi A61M 25/0097
9,814,814 B2 11/2017 Corbett et al.
D895,801 S * 9/2020 Tanaka D24/152
D896,956 S * 9/2020 Harder D24/135
D931,464 S * 9/2021 Berkely D24/176
2020/0330664 A1 10/2020 Ship et al.
2022/0160997 A1 * 5/2022 Hou A61B 90/39

OTHER PUBLICATIONS

145 Degree Cardiac Pigtail Catheters, meritoem.com, [Post date unknown], [Site seen Oct. 26, 2022], Seen at URL: <https://meritoem.com/product/7776-c3/> (Year: 2022).*

* cited by examiner

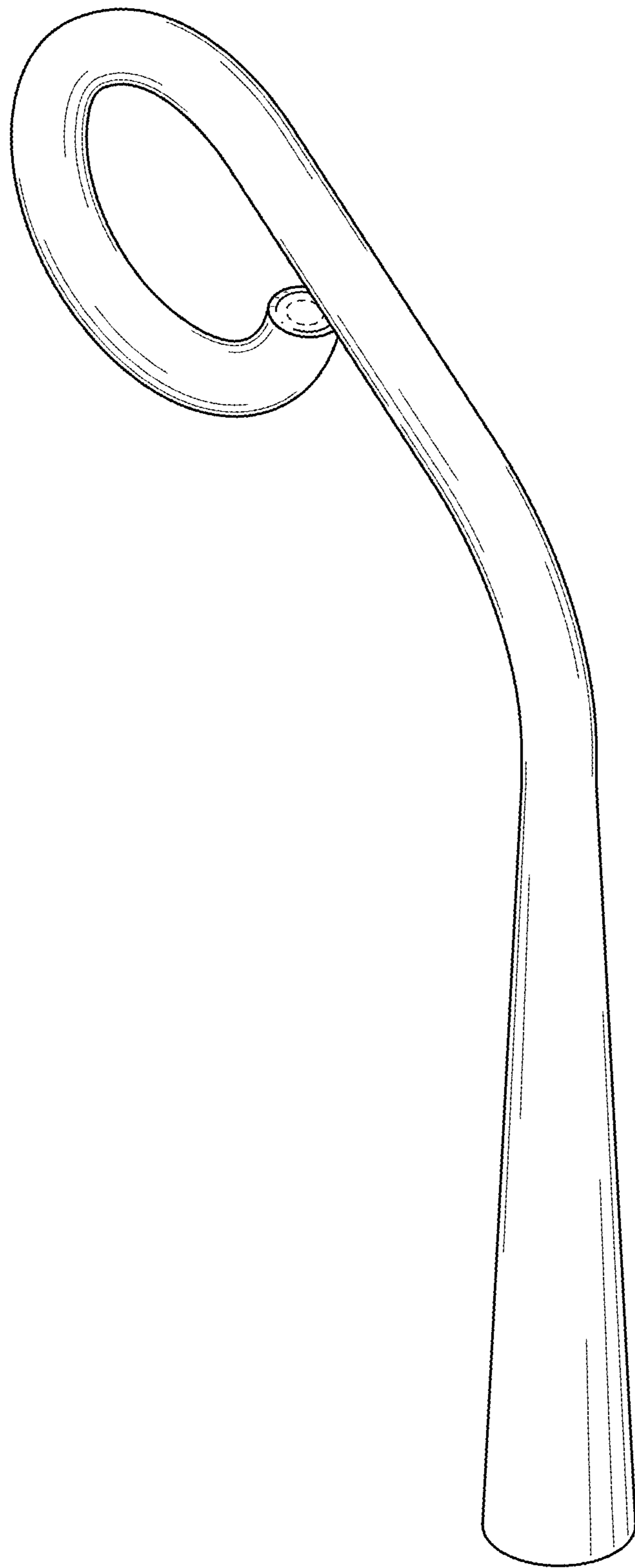

FIG. 1

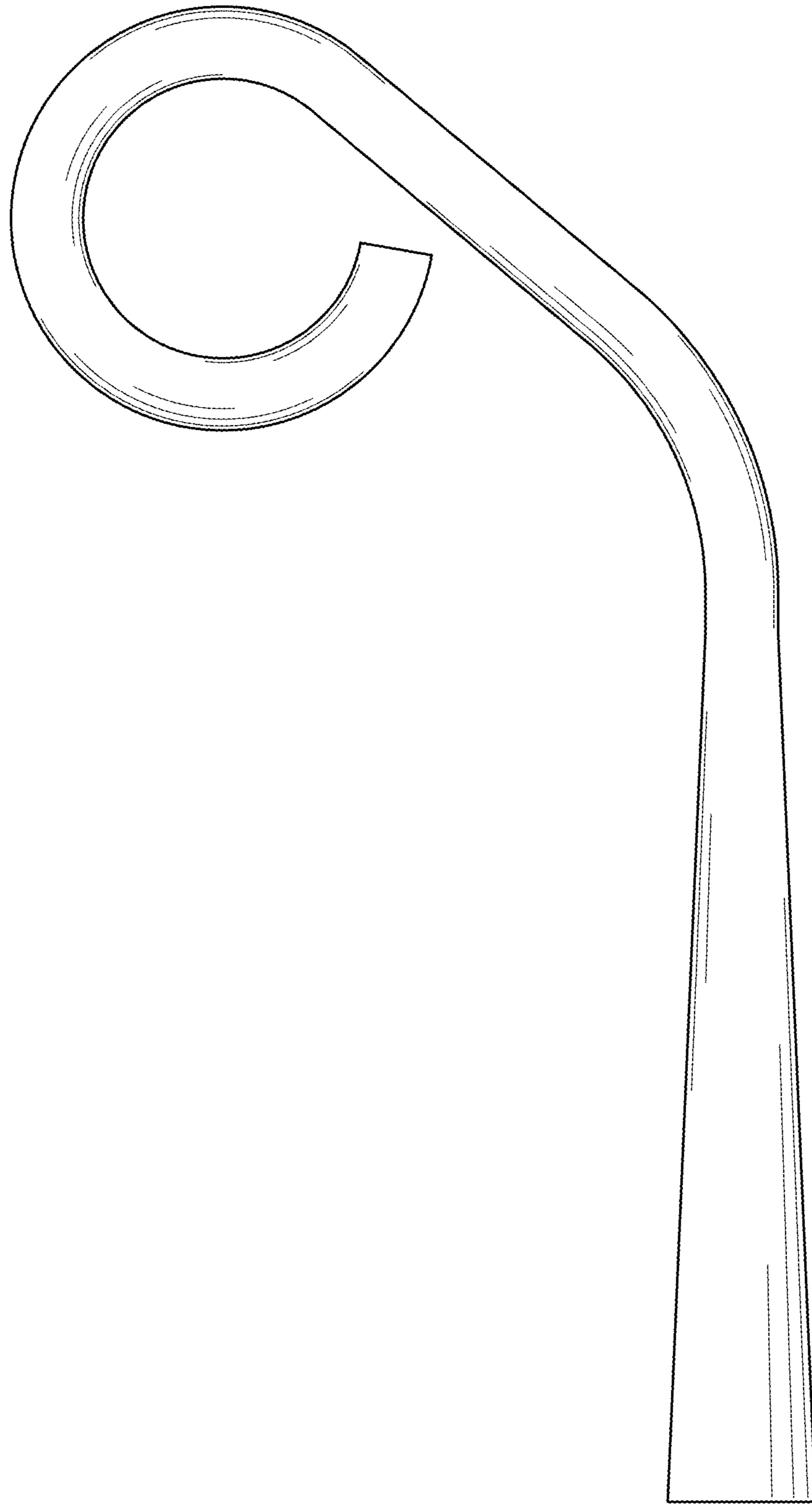

FIG. 2

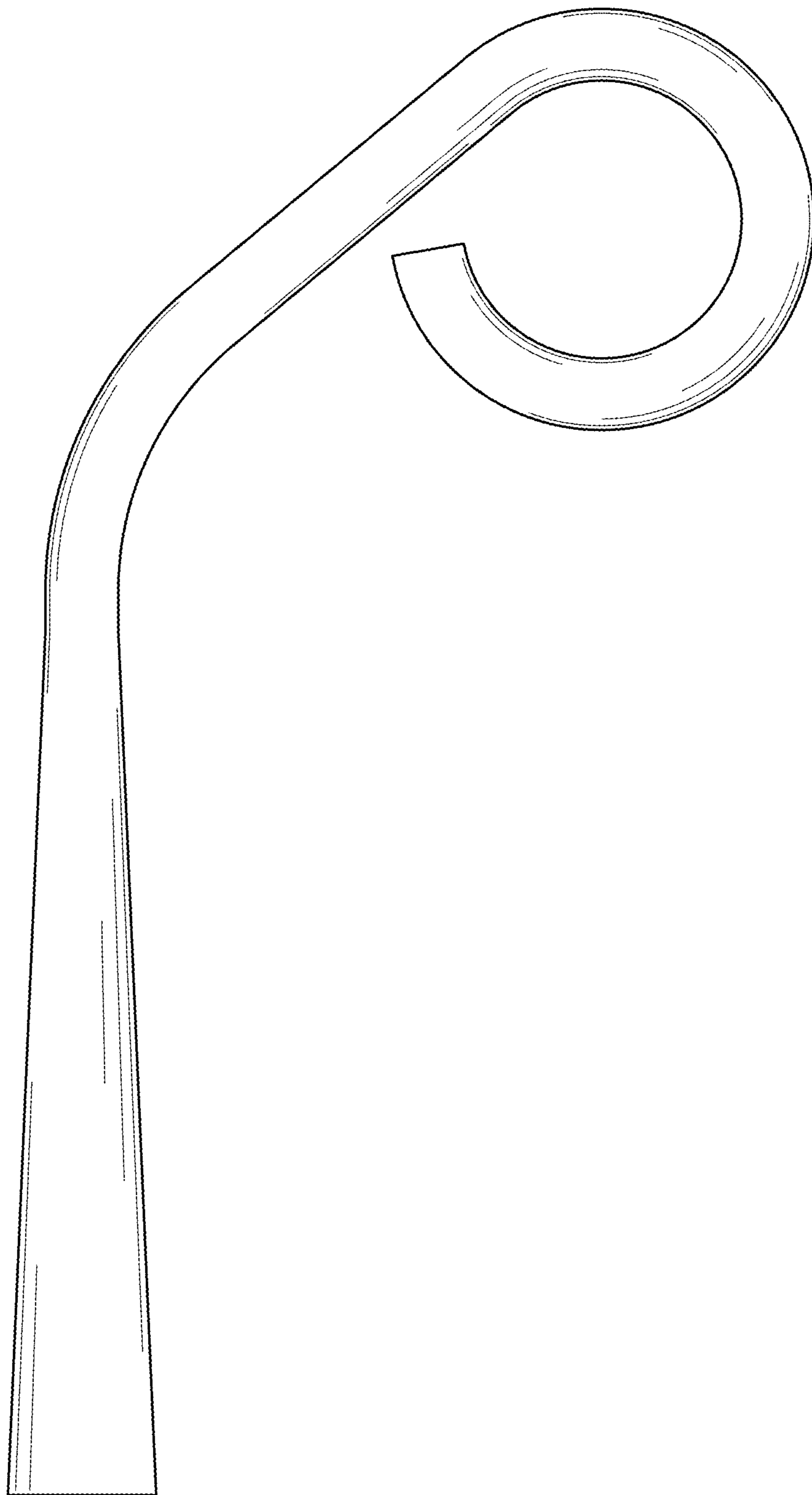

FIG. 3

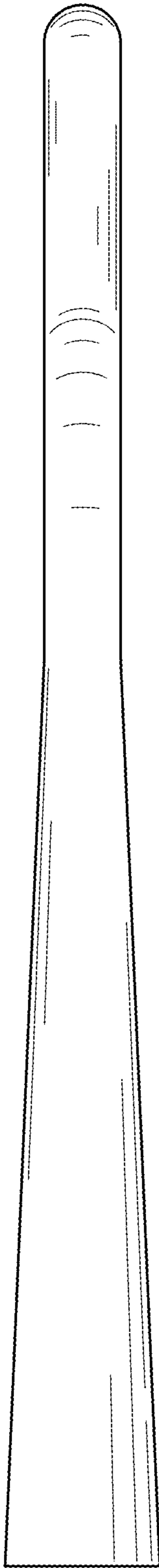

FIG. 4

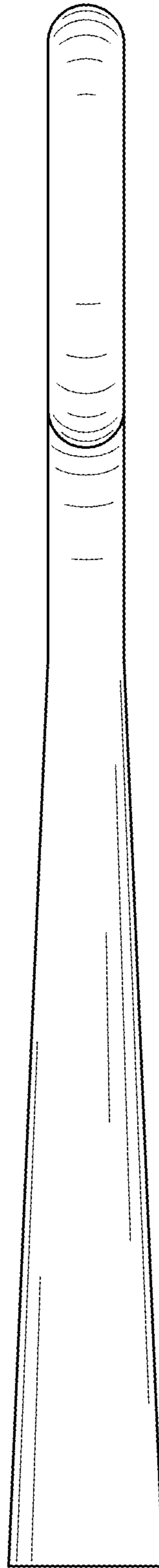

FIG. 5

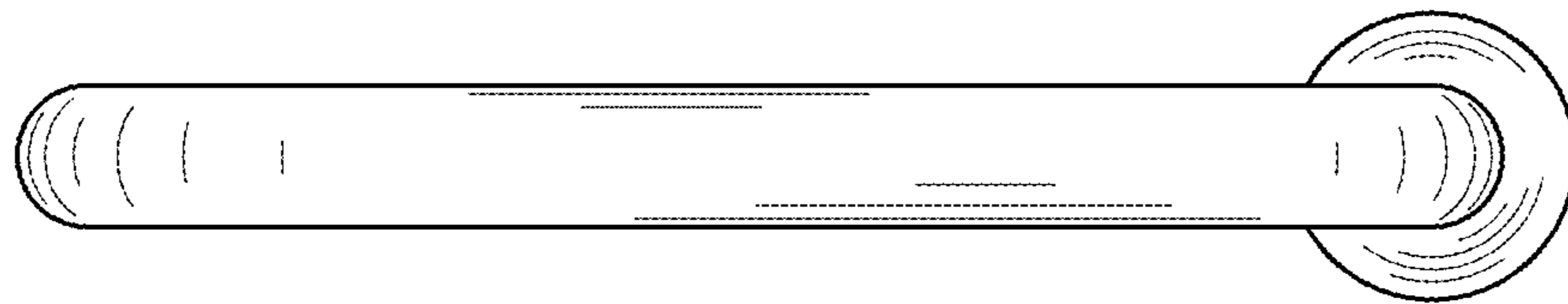

FIG. 6

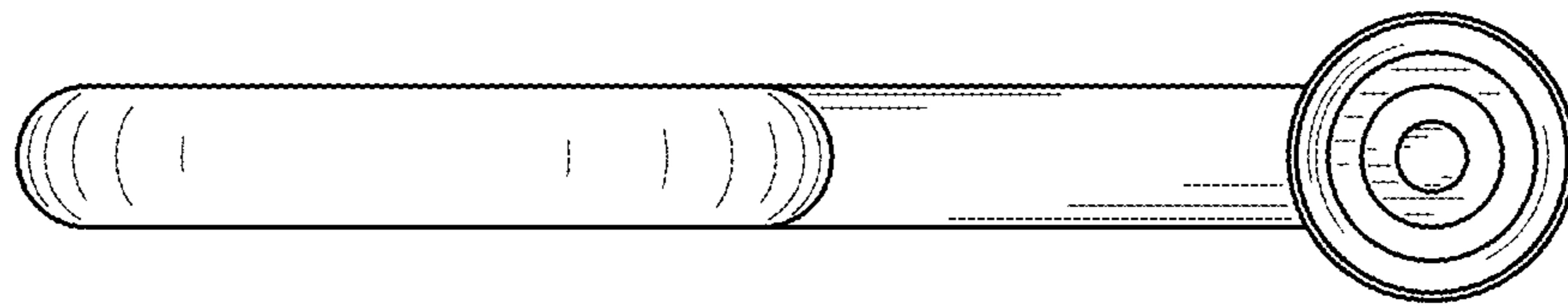

FIG. 7

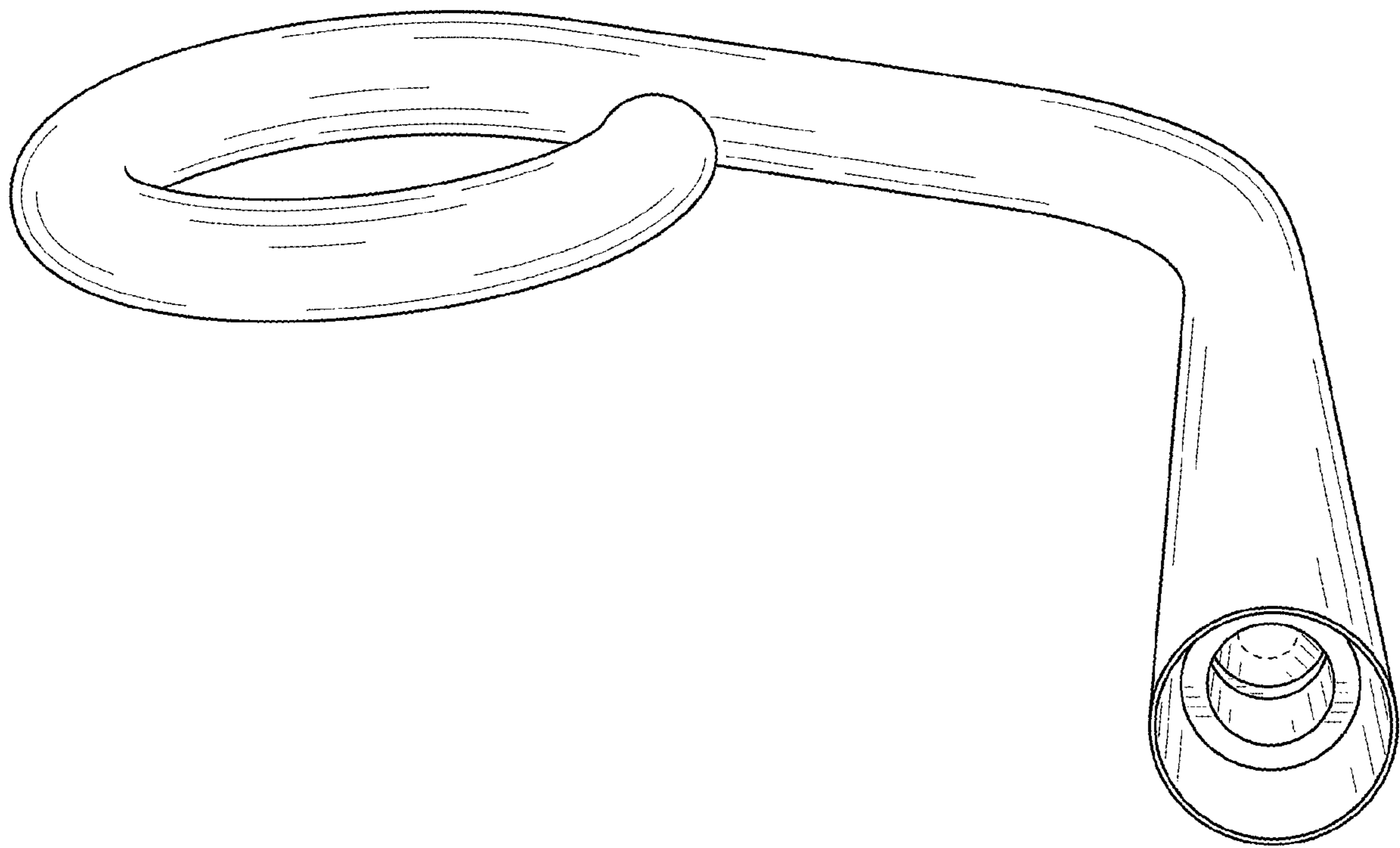

FIG. 8

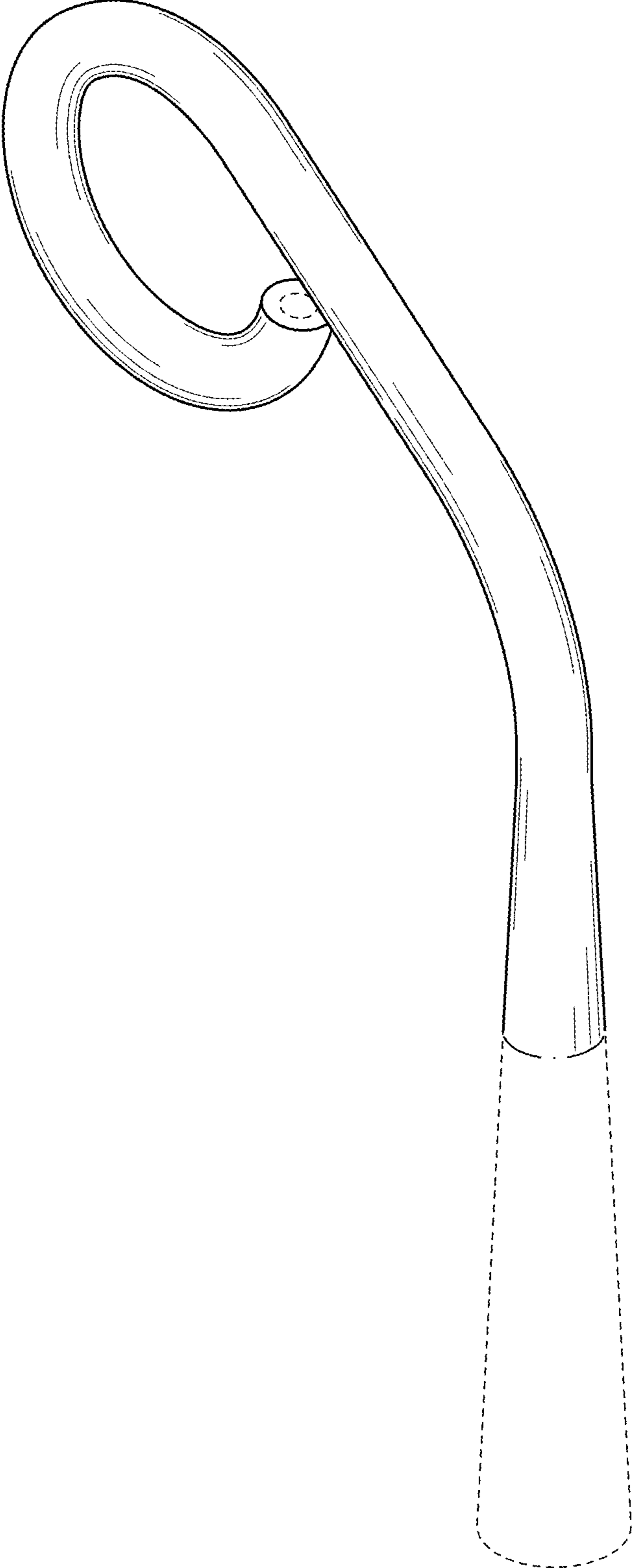

FIG. 9

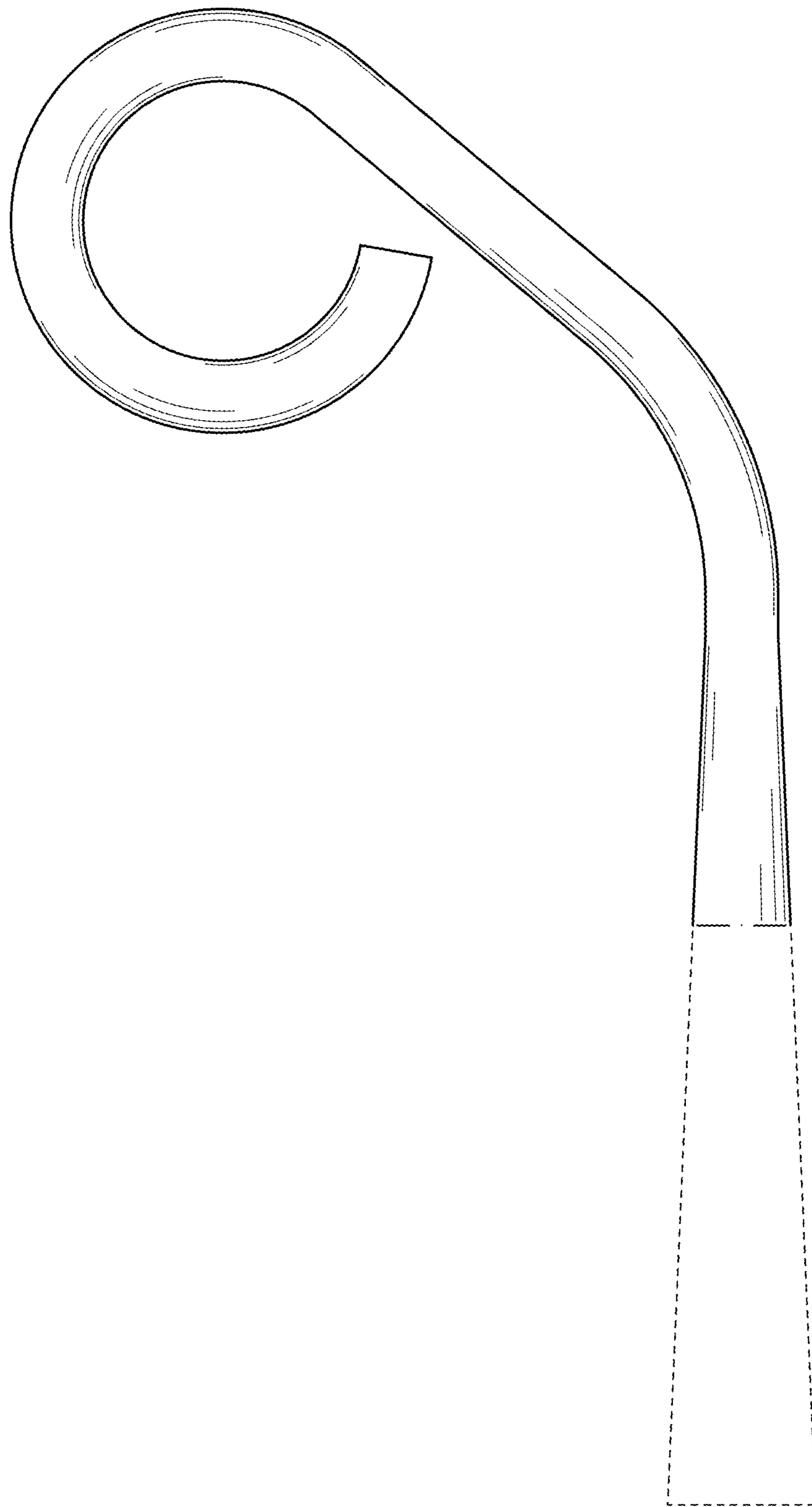

FIG. 10

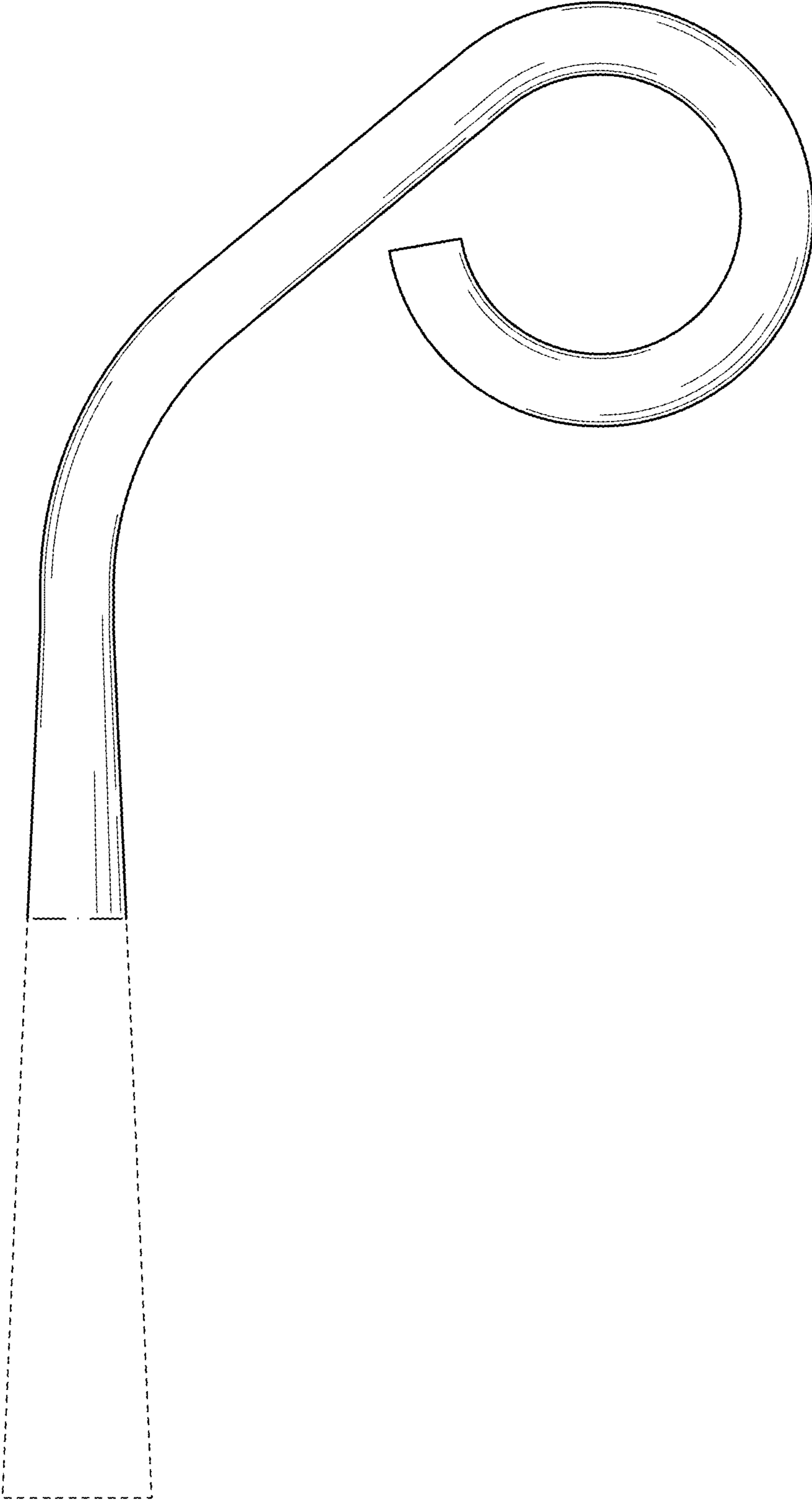

FIG. 11

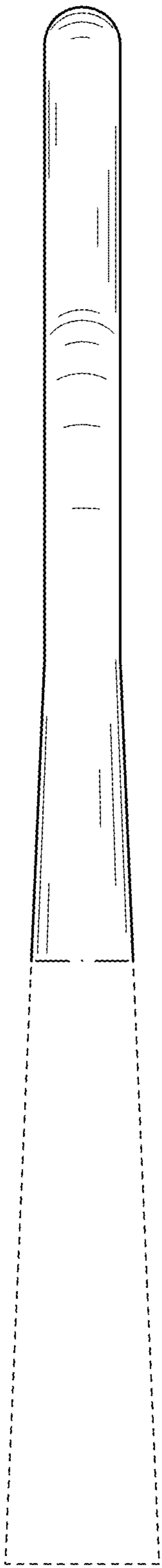

FIG. 12

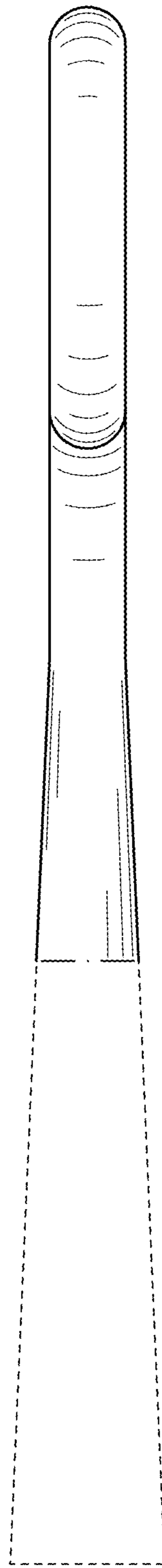

FIG. 13

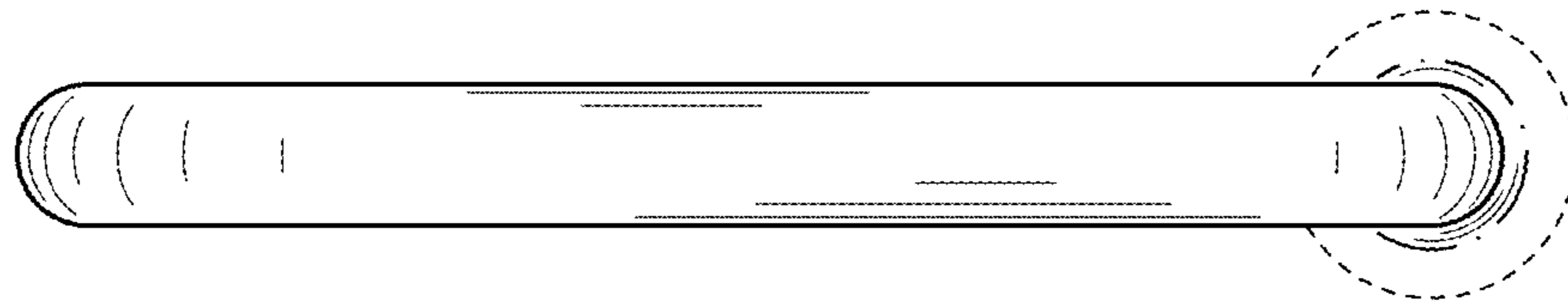

FIG. 14

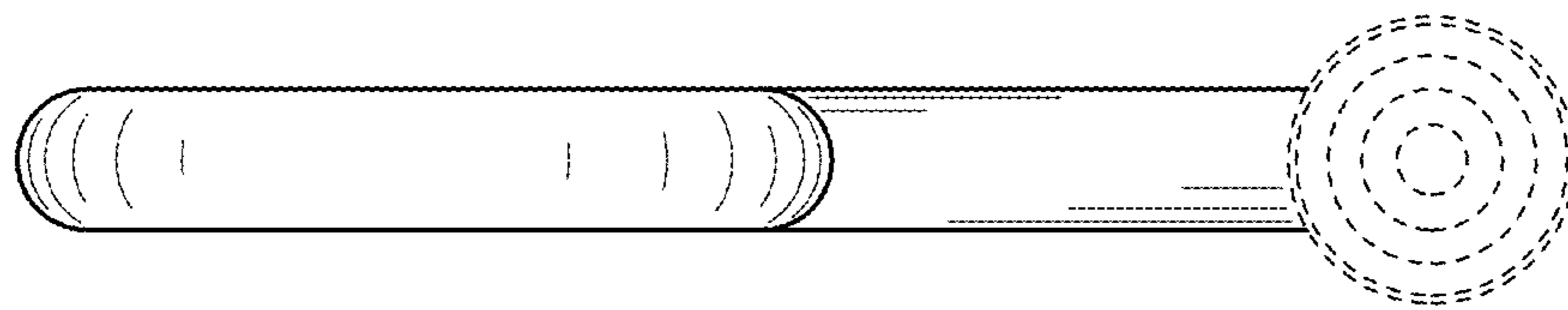

FIG. 15

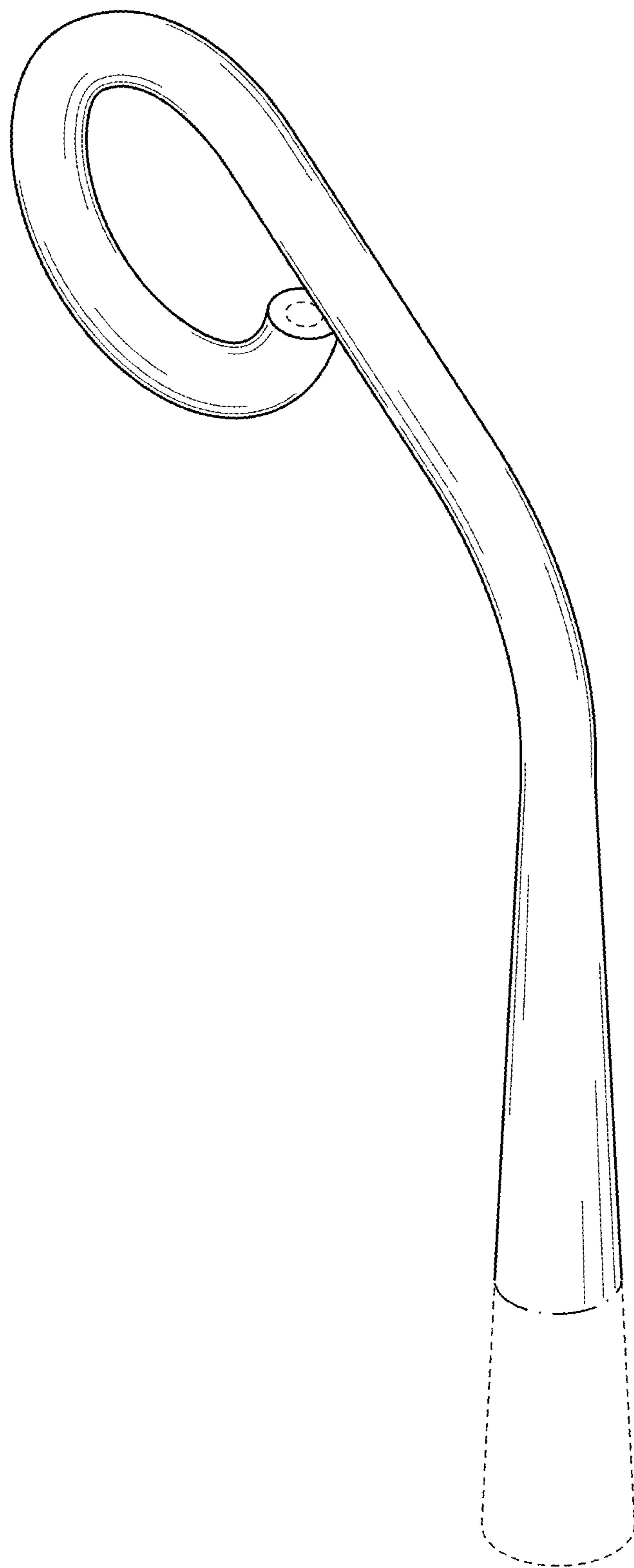

FIG. 16

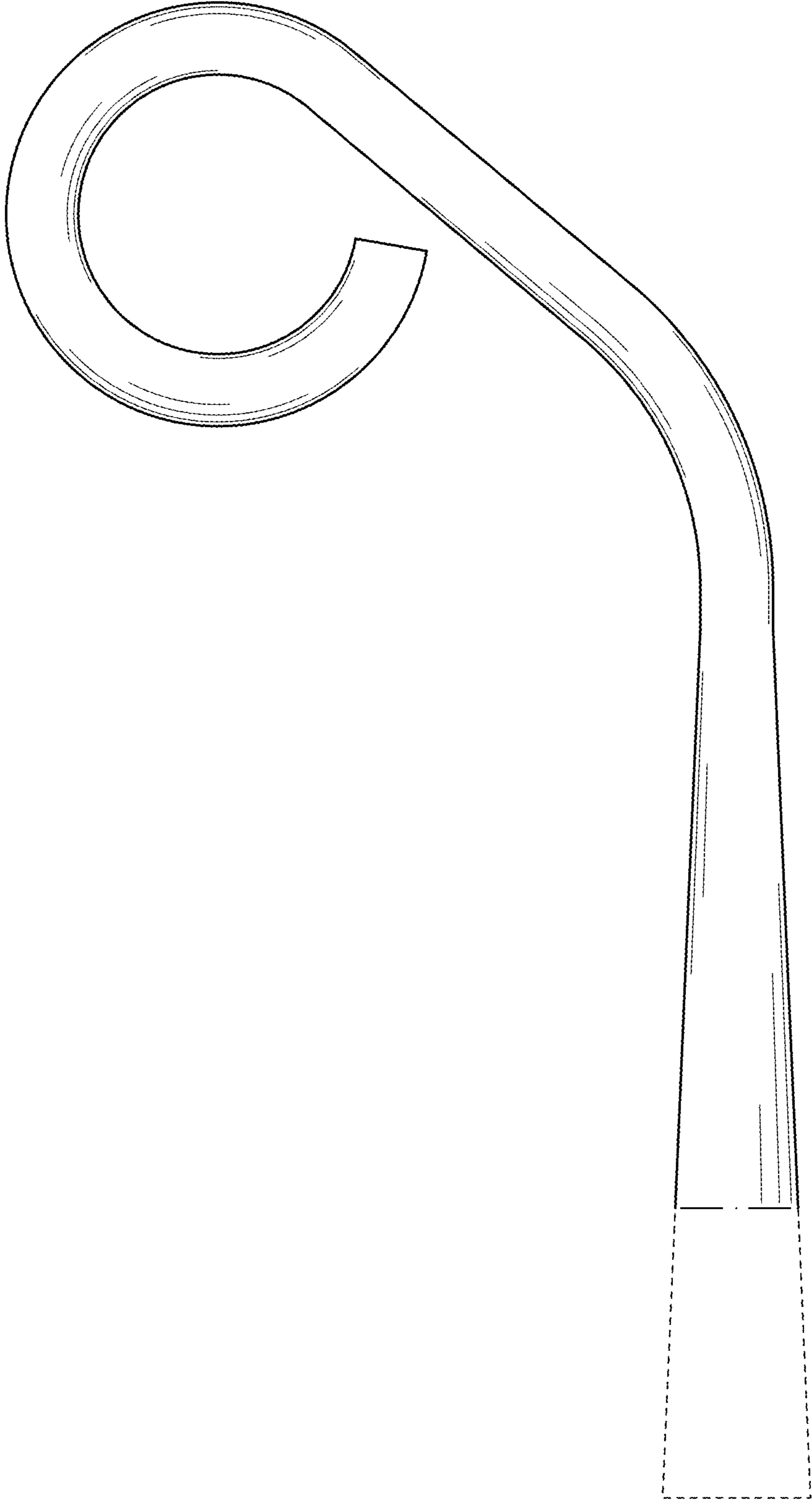

FIG. 17

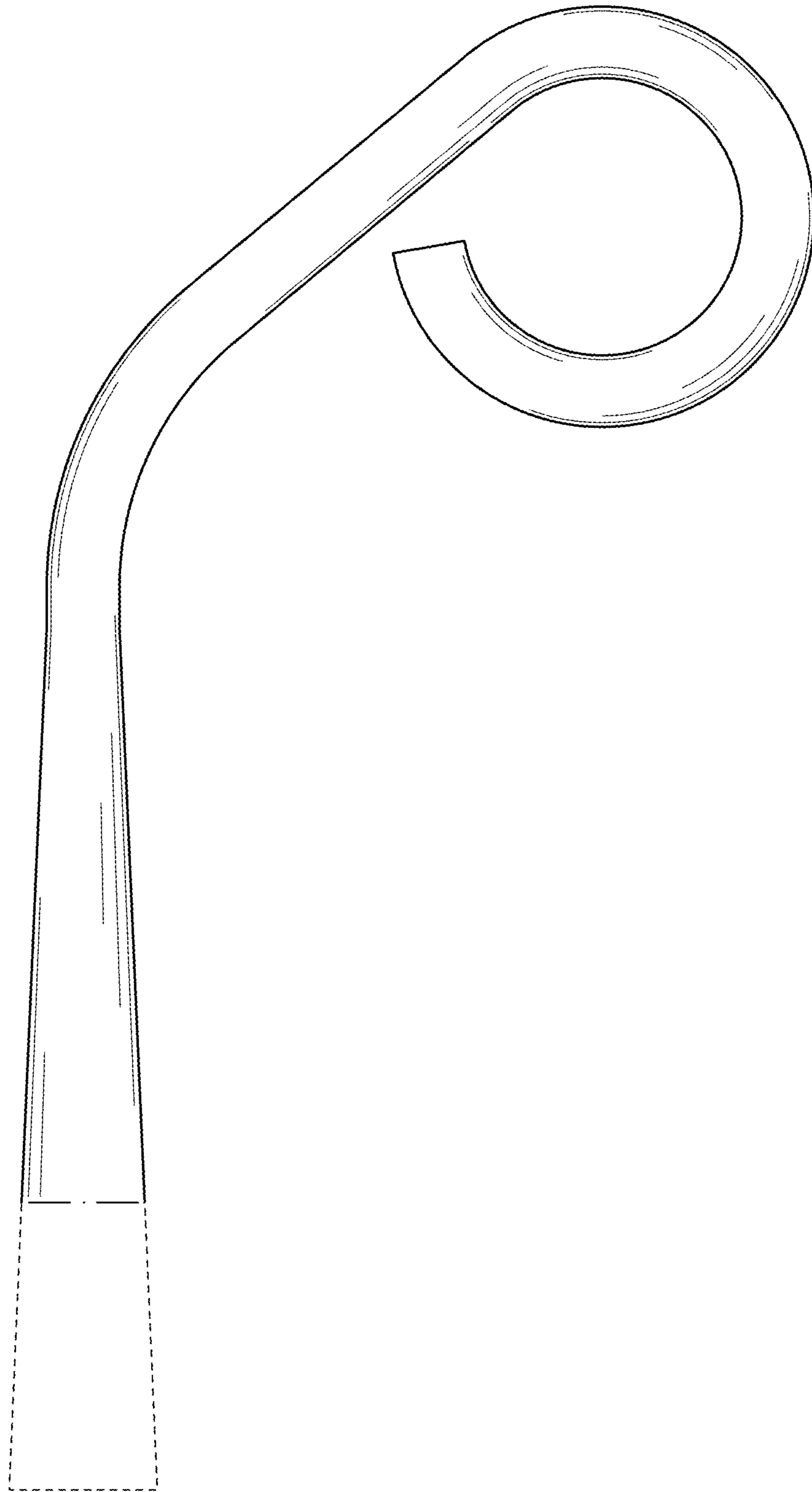

FIG. 18

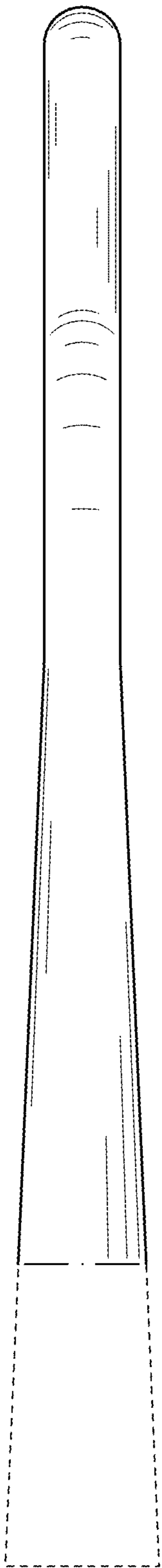

FIG. 19

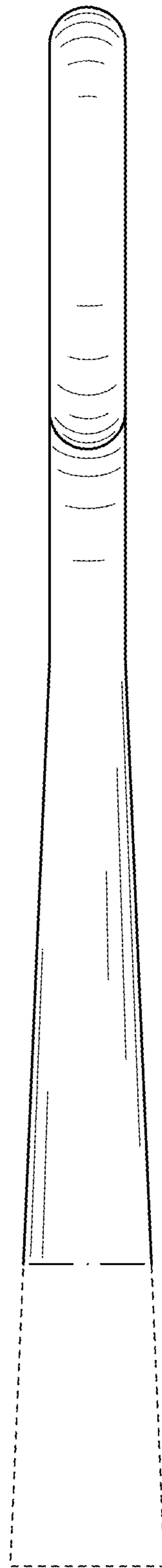

FIG. 20

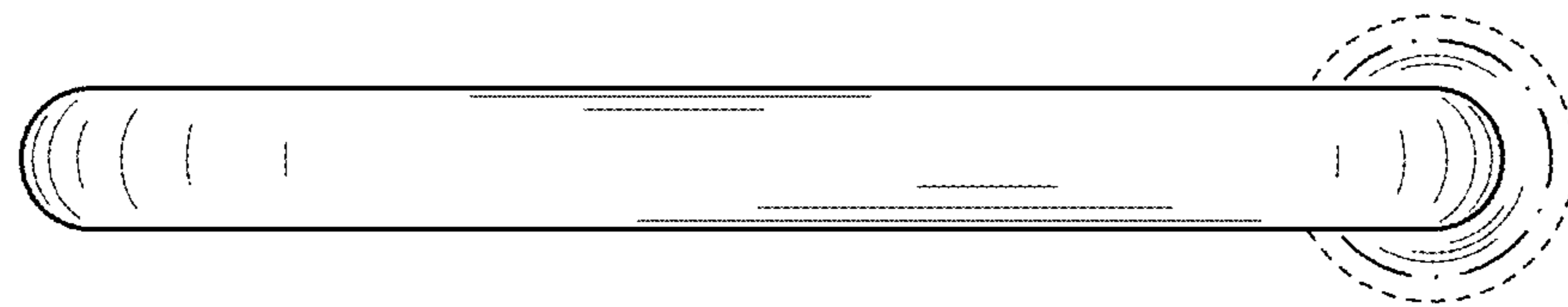

FIG. 21

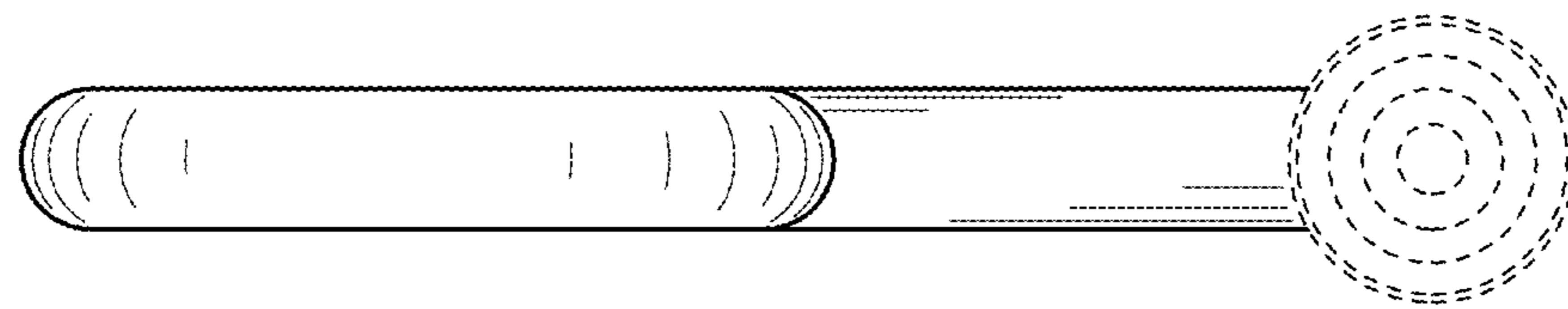

FIG. 22