



US00D980957S

(12) **United States Design Patent**
Hong

(10) **Patent No.:** **US D980,957 S**
(45) **Date of Patent:** **** Mar. 14, 2023**

- (54) **FIRE PIT**
- (71) Applicant: **Bear U.S.A., Inc.**, Palisades Park, NJ (US)
- (72) Inventor: **Albert B. J. Hong**, Alpine, NJ (US)
- (73) Assignee: **Bear U.S.A., Inc.**, Palisades Park, NJ (US)
- (**) Term: **15 Years**
- (21) Appl. No.: **29/722,390**
- (22) Filed: **Jan. 29, 2020**
- (51) **LOC (14) Cl.** **23-03**
- (52) **U.S. Cl.**
USPC **D23/332**
- (58) **Field of Classification Search**
USPC D23/332, 314, 343, 348, 350, 346, 342, D23/335, 347; D7/332-337, 402-405, D7/352
CPC F24C 1/16; F24C 5/00; F24C 3/14; A47J 33/00; A47J 37/0763; A47J 37/07; A47J 2037/0777; F24B 1/18; F24B 1/182; F24B 1/1808; F24B 1/181; F24B 1/195; F24B 1/191
See application file for complete search history.

4,971,045 A * 11/1990 Probst F24B 1/205
126/29
D734,974 S * 7/2015 Barford D7/332
D849,907 S * 5/2019 Zhou D23/335
2014/0326720 A1 * 11/2014 Probst A47J 37/0772
220/6

FOREIGN PATENT DOCUMENTS

EM 002036392-0002 * 5/2012

OTHER PUBLICATIONS

Made O' Metal Interlocking Fire Pit, <https://madeometal.co.uk/home/10-interlocking-fire-pit.html#/grille-yes>, last visited Jan. 16, 2020.

<https://www.ebay.com/itm/Made-O-Metal-Interlocking-Fold-Away-Brazier-Fire-Pit-Garden-Patio-Firepit-Stove-/252040975402>, last visited Jan. 16, 2020.

* cited by examiner

Primary Examiner — Ania Aman

(74) *Attorney, Agent, or Firm* — David M. Quinlan, P.C.

(57) **CLAIM**

The ornamental design for a fire pit, as shown and described.

DESCRIPTION

FIG. 1 is an isometric depiction of a fire pit according to my new design;
 FIG. 2 is a front view of the of the fire pit shown in FIG. 1;
 FIG. 3 is a rear view of the fire pit shown in FIG. 1;
 FIG. 4 is a view of the right side of the fire pit shown in FIG. 1;
 FIG. 5 is a view of the left side of the fire pit shown in FIG. 1;
 FIG. 6 is a top view of the fire pit shown in FIG. 1; and,
 FIG. 7 is a bottom view of the fire pit shown in FIG. 1.

1 Claim, 4 Drawing Sheets

(56) **References Cited**
U.S. PATENT DOCUMENTS

- D98,885 S * 3/1936 Pearson D7/332
- 2,038,226 A * 4/1936 Lang F24B 1/202
D7/332
- 2,221,098 A * 11/1940 Langsam F24B 1/202
126/30
- D142,417 S * 9/1945 Jones D7/332
- D220,150 S * 3/1971 Roestenbug D7/332
- 3,682,154 A * 8/1972 Mollere A47J 37/0768
229/117.02
- 3,946,651 A * 3/1976 Garcia A47J 37/067
99/450

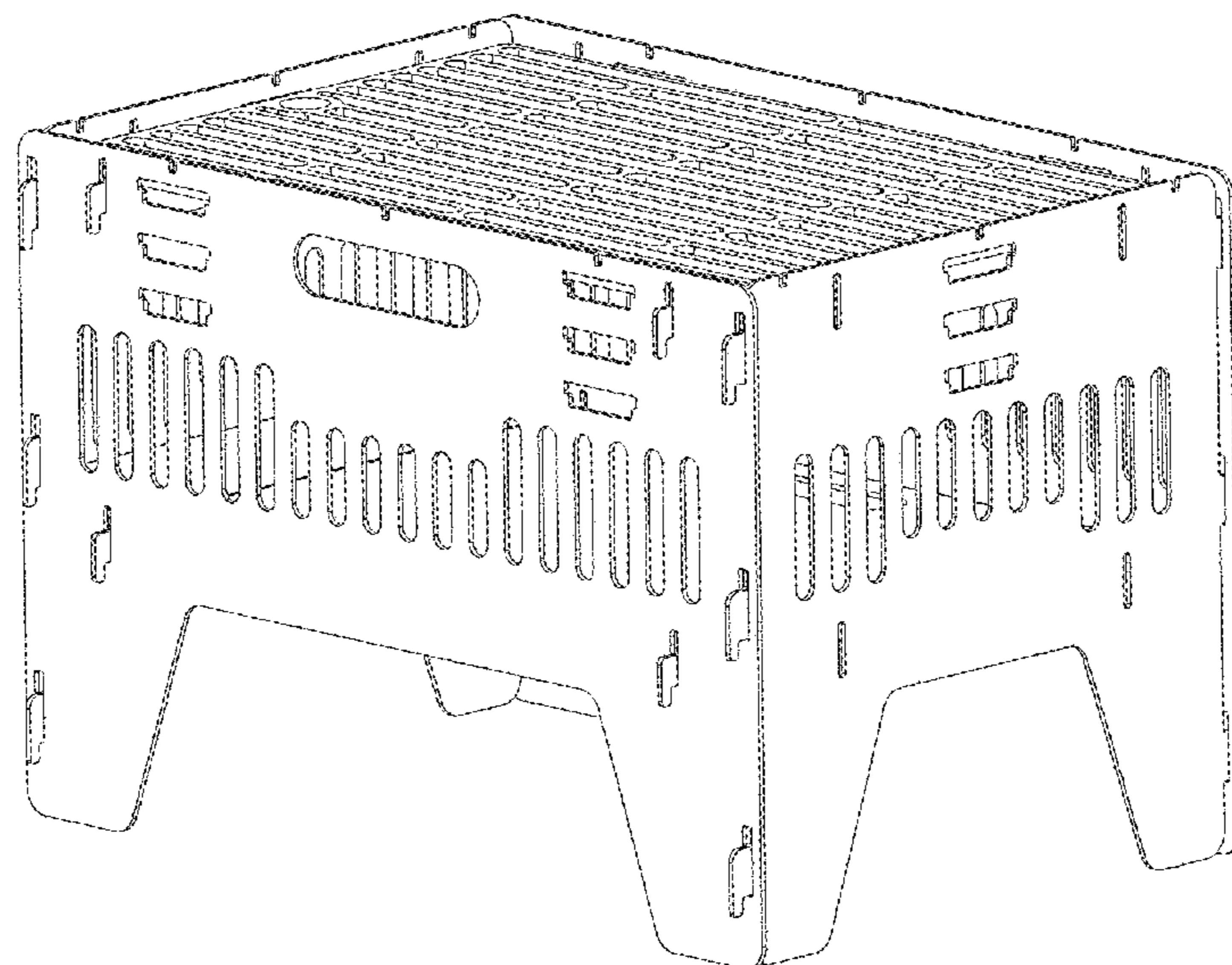

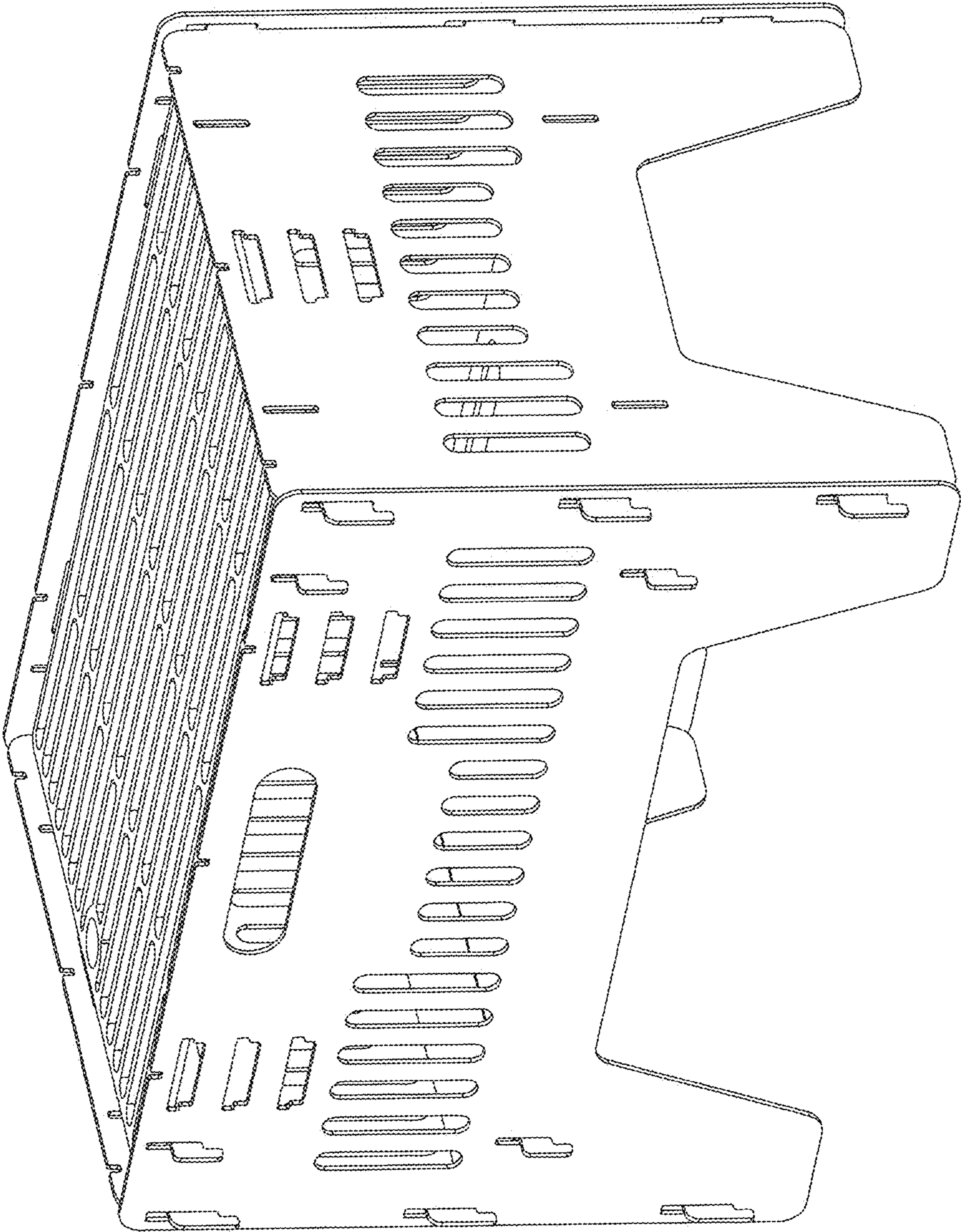

FIG. 1

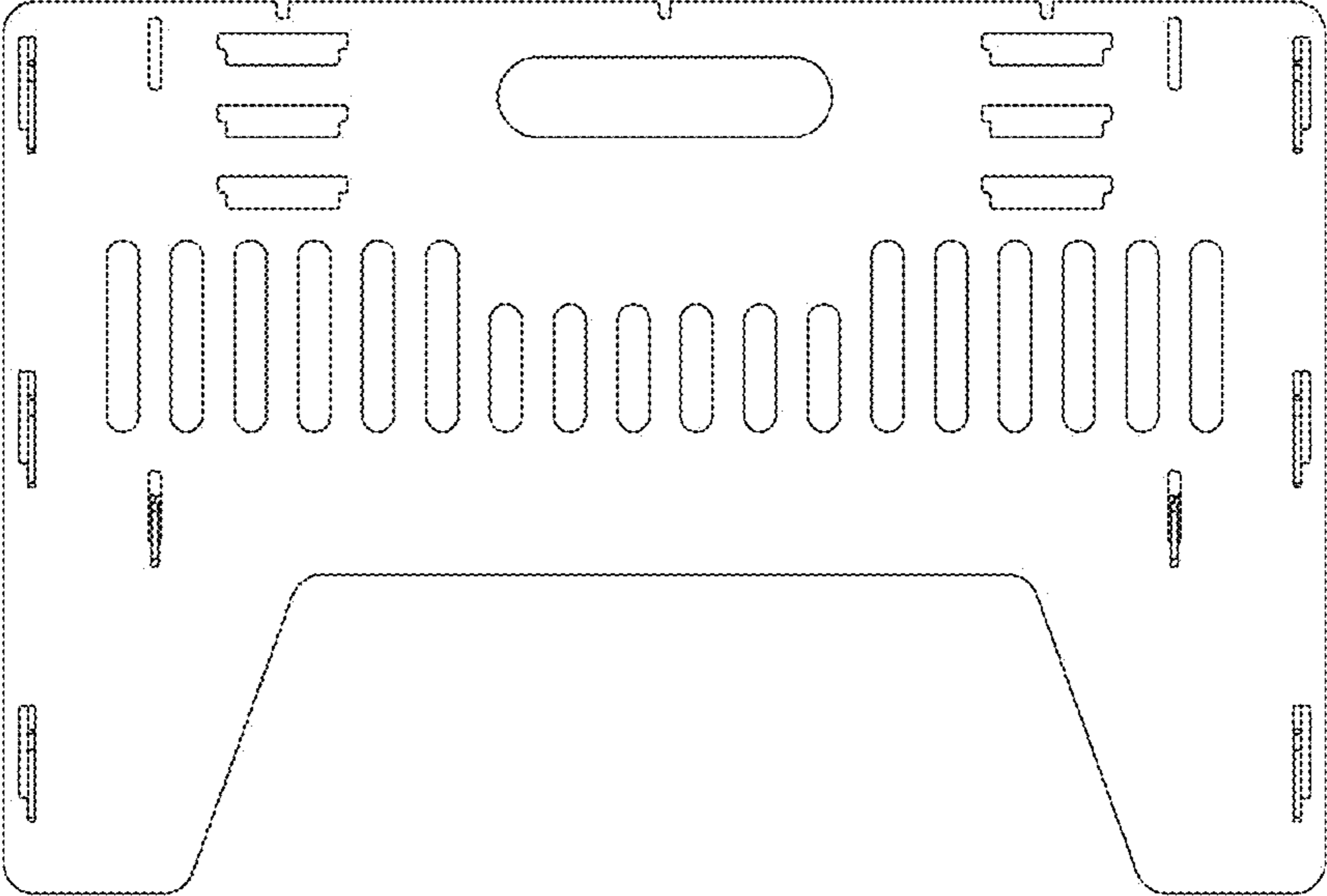

FIG. 2

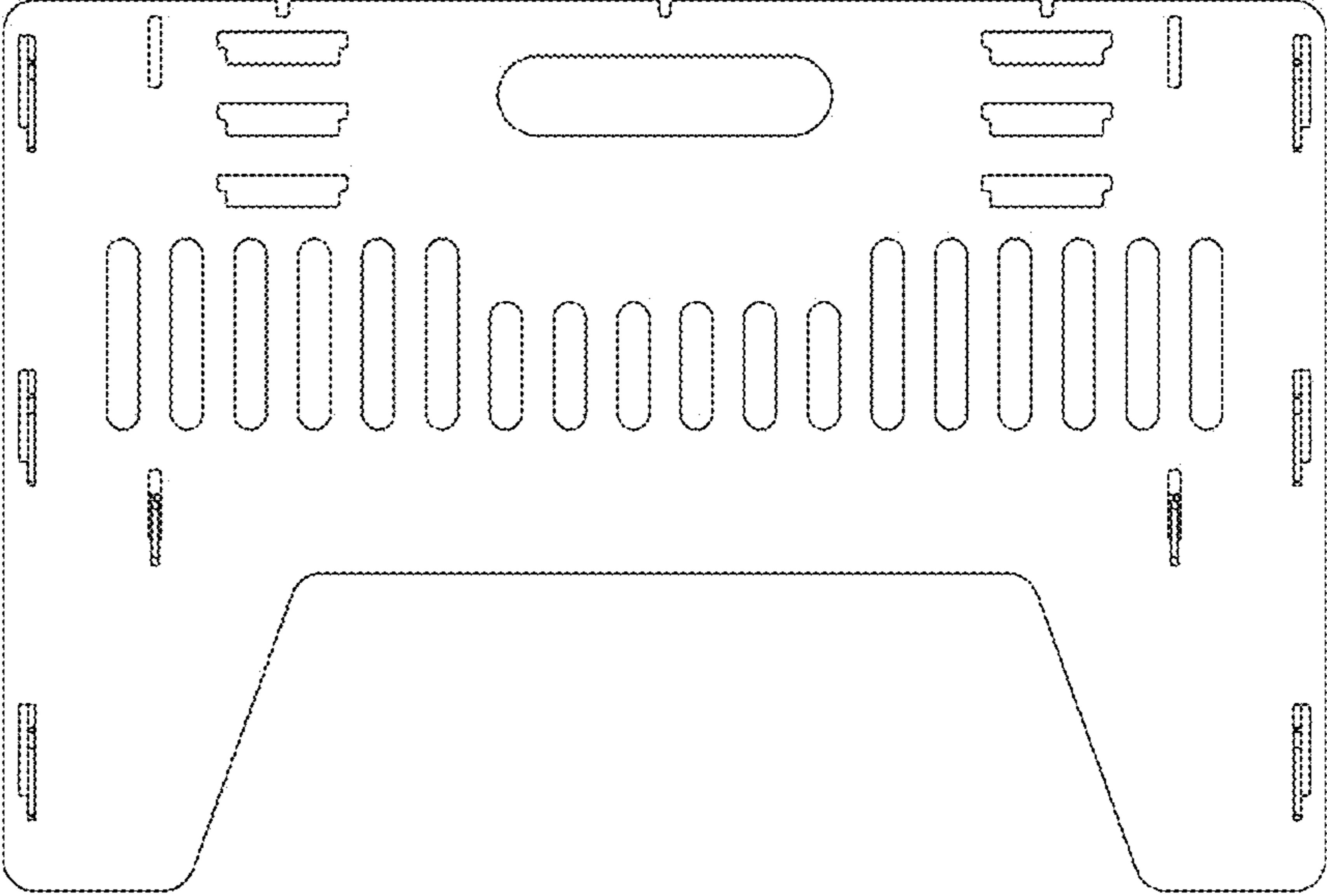

FIG. 3

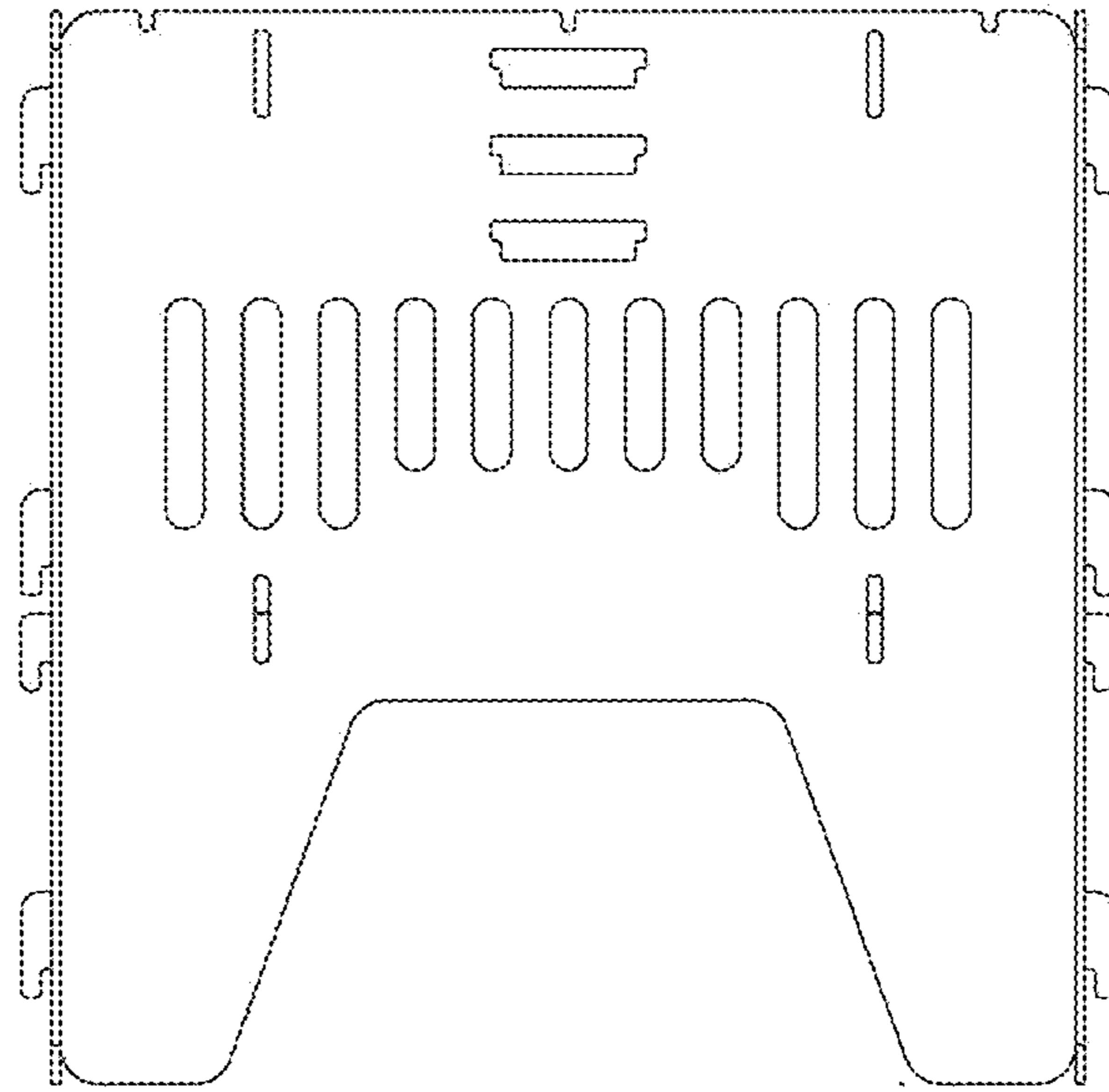

FIG. 4

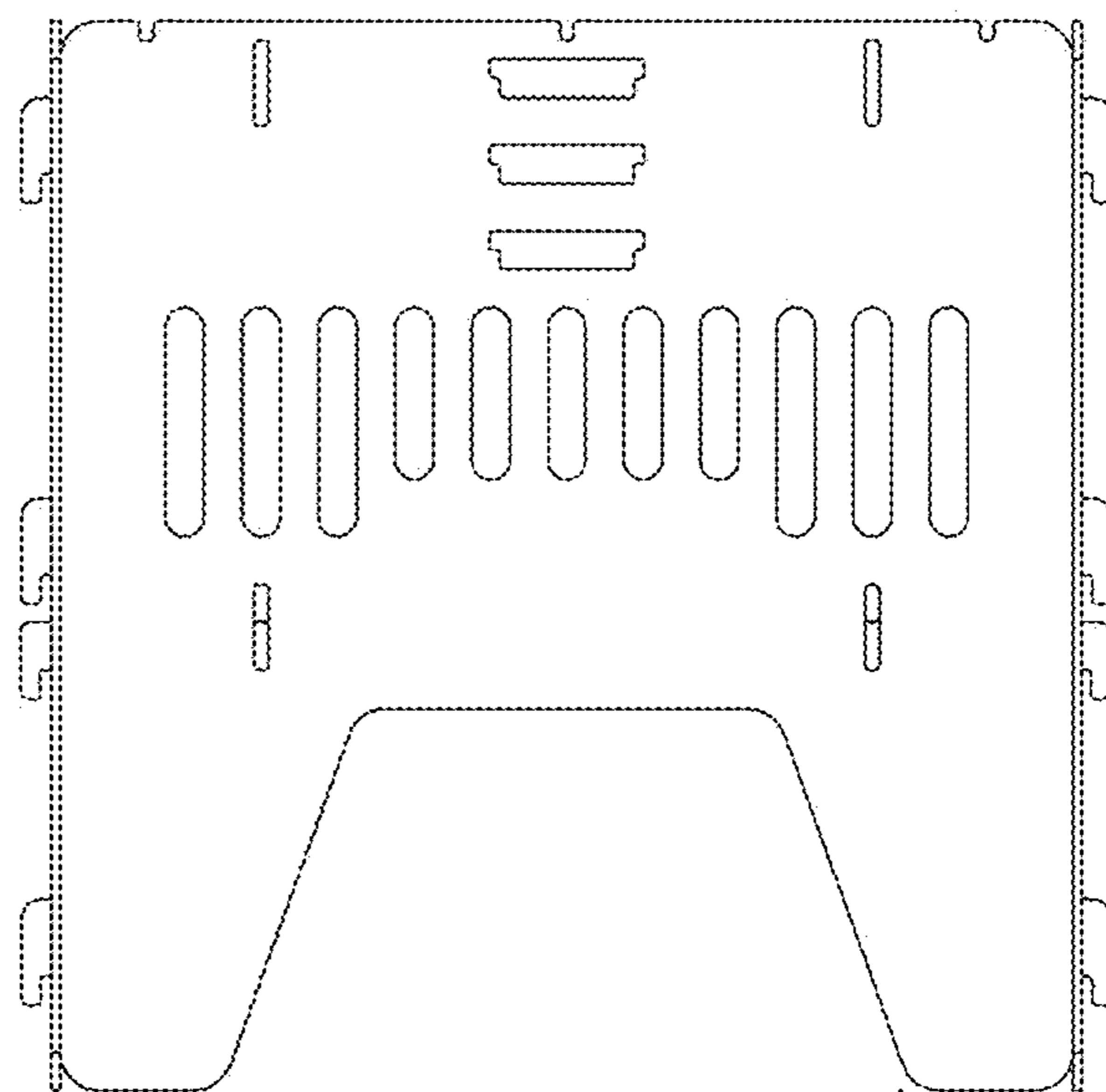

FIG. 5

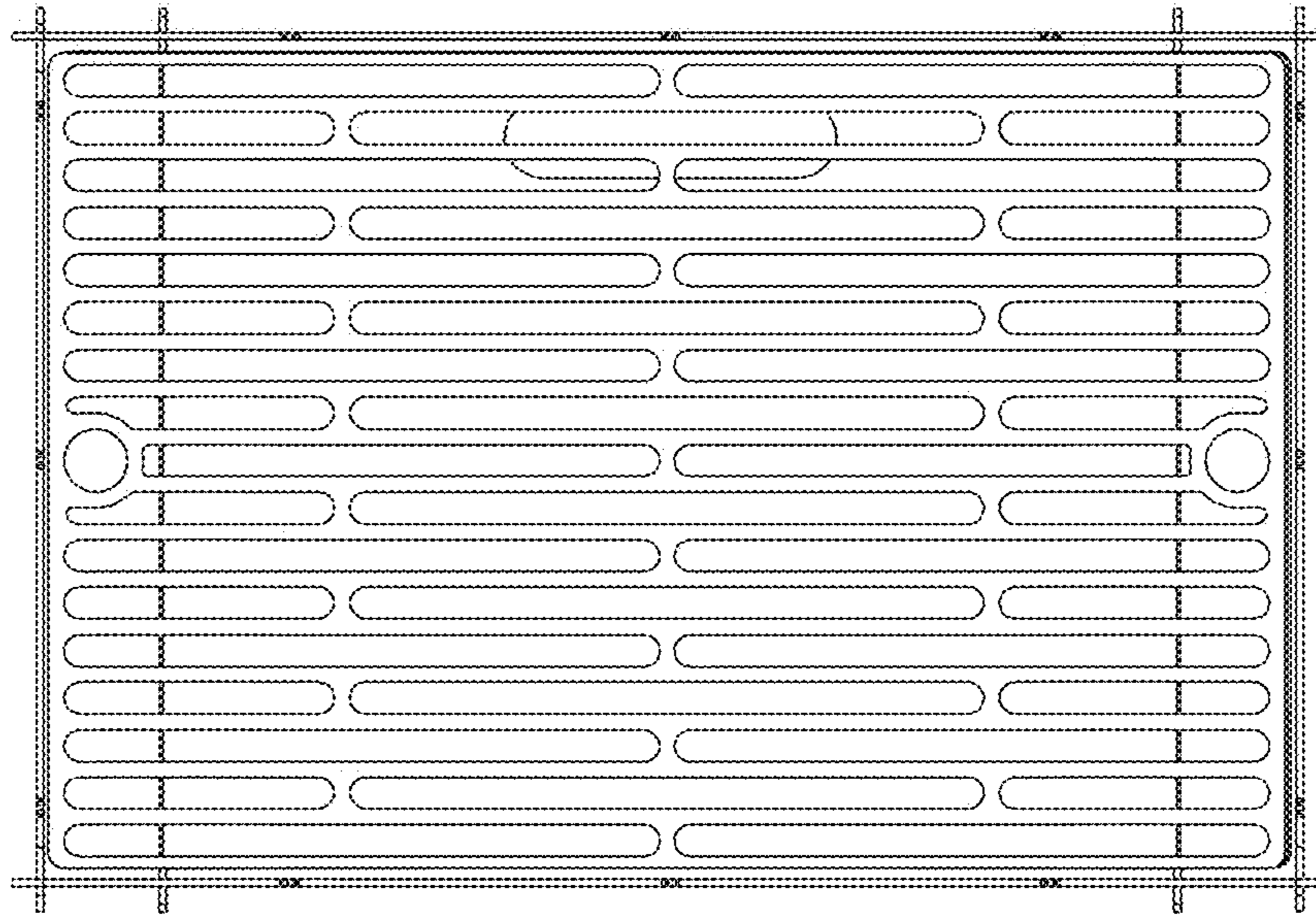

FIG. 6

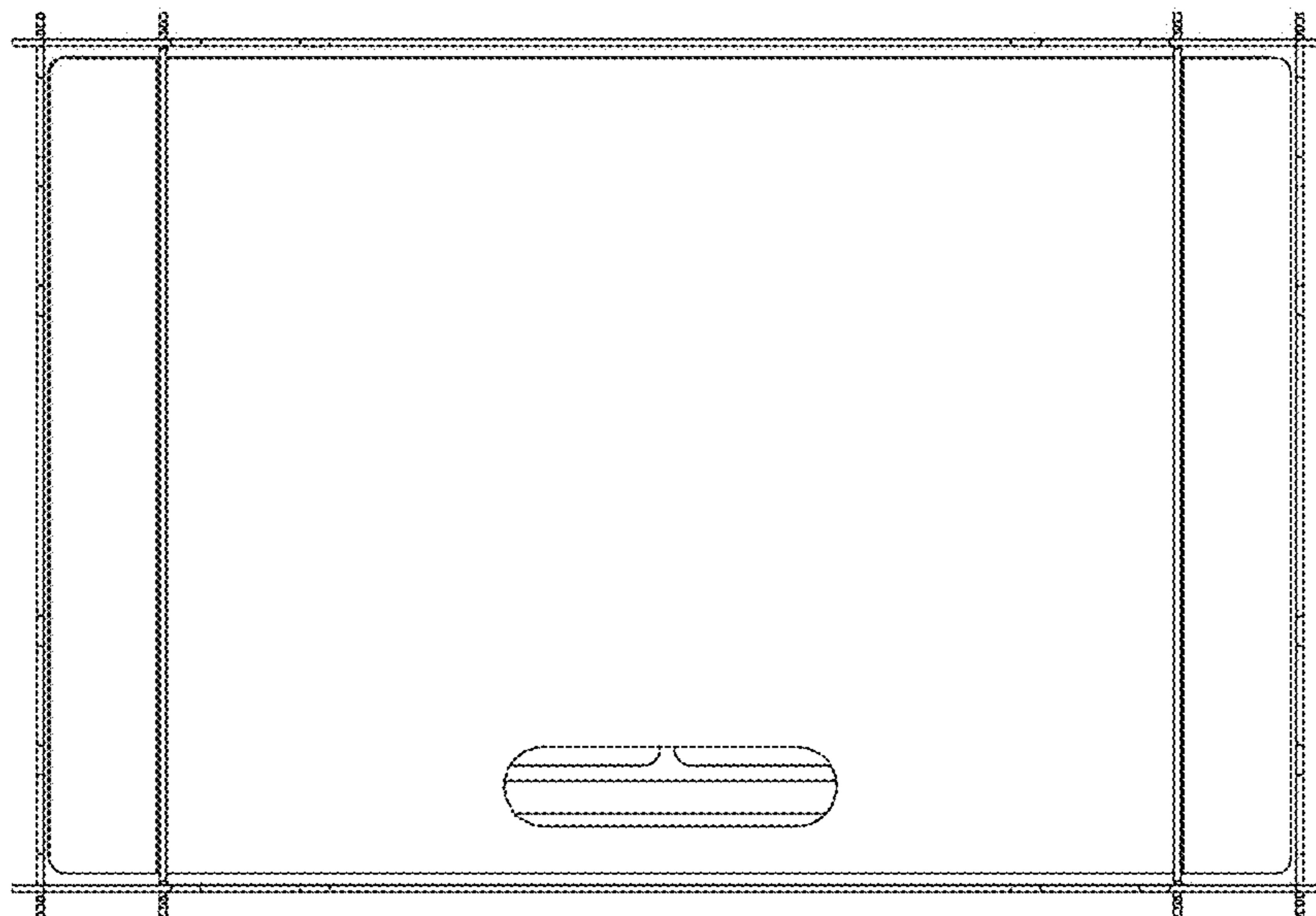

FIG. 7