



US00D980901S

(12) **United States Design Patent** (10) **Patent No.:** **US D980,901 S**
Gu (45) **Date of Patent:** **** Mar. 14, 2023**

(54) **CONFIDENTIAL ROLLER**
(71) Applicant: **ZHENGZHOU YINSITA STATIONERY CO., LTD.**, Zhengzhou (CN)

D510,748 S * 10/2005 Faber D18/15
D557,340 S * 12/2007 Nagahama D19/66
D562,152 S * 2/2008 Beam D9/723
D570,918 S * 6/2008 Rushe D19/69
D614,688 S * 4/2010 Wilflingseder D18/15
D630,250 S * 1/2011 Yoon D19/66

(Continued)

(72) Inventor: **Sufang Gu**, Luohe (CN)
(73) Assignee: **ZHENGZHOU YINSITA STATIONERY CO., LTD.**, Zhengzhou (CN)

FOREIGN PATENT DOCUMENTS

CN 302953957 * 10/2014
CN 306973356 * 11/2021
EM 000742176-0001 * 12/2007

(**) Term: **15 Years**

OTHER PUBLICATIONS

(21) Appl. No.: **29/812,941**

Amazon. Link: https://www.amazon.com/Lomil-Identity-Protection-Roller-Stamps/dp/B09WDCL7ZK/ref=sr_1_2?crid=23CMQF296TOT&keywords=B09WDCL7ZK&qid=1664911859&s=office-products&sprefix=b09wdcl7zk%2Coffice-products%2C136&sr=1-2. Apr. 13, 2022. Lomil Identity Protection Roller Stamps 2 Pack. (Year: 2022).*

(22) Filed: **Oct. 26, 2021**

(Continued)

(30) **Foreign Application Priority Data**

Aug. 6, 2021 (CN) 202130509239.2

(51) **LOC (14) Cl.** **19-02**

(52) **U.S. Cl.**
USPC **D18/15**

(58) **Field of Classification Search**
USPC D18/14, 15, 16, 17, 18, 19, 50;
D19/65-71
CPC . B41J 2/1752; B41J 3/36; B41J 29/023; B41J
2/17526; B41J 3/28; B41K 1/00; B41K
1/38; B41K 1/006; B41K 1/02; B41K
1/08; B41K 1/40; B41K 1/42; B41K
1/52; B41K 1/54; B41K 1/56; B41K
1/36; B23K 26/00; B23K 26/10; B41C
3/04; B41D 7/00

See application file for complete search history.

Primary Examiner — Lauren D McVey

(57) **CLAIM**

The ornamental design for a confidential roller, as shown and described.

DESCRIPTION

FIG. 1 is a perspective view of a confidential roller showing my new design;
FIG. 2 is a front elevational view thereof;
FIG. 3 is a rear elevational view thereof;
FIG. 4 is a left side elevational view thereof;
FIG. 5 is a right side elevational view thereof;
FIG. 6 is a top plan view thereof; and,
FIG. 7 is a bottom plan view thereof.
The broken lines and areas within the broken lines depict portions of the confidential roller that form no part of the claimed design.

(56) **References Cited**

U.S. PATENT DOCUMENTS

D308,462 S * 6/1990 Komatsu D8/99
D339,819 S * 9/1993 Chen D18/15
D400,586 S * 11/1998 Yuen D19/65
D450,749 S * 11/2001 Faber D18/15
D463,494 S * 9/2002 Mori D19/65

1 Claim, 7 Drawing Sheets

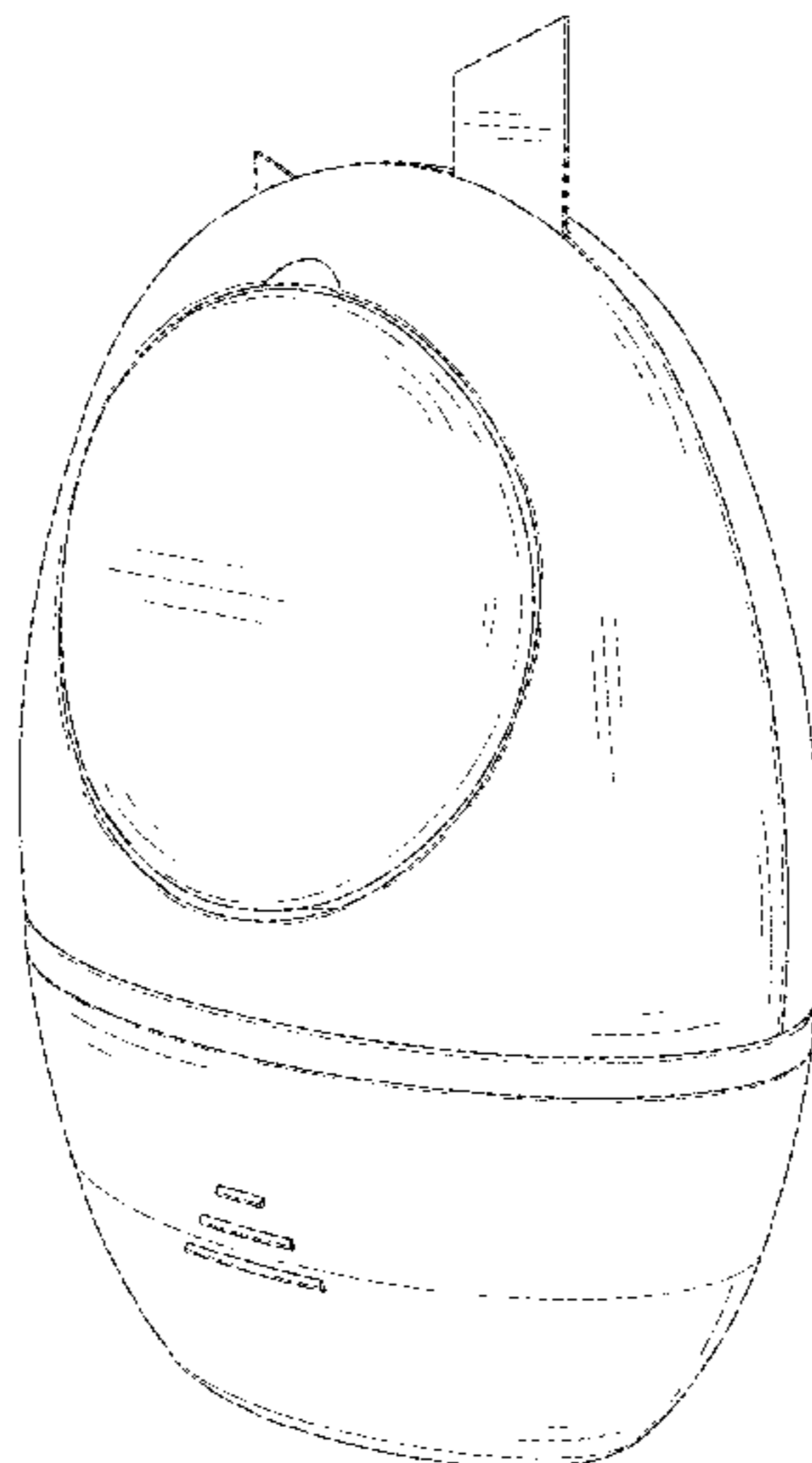

(56)

References Cited

U.S. PATENT DOCUMENTS

D685,029 S * 6/2013 Cooper D19/69
D709,947 S * 7/2014 Broen D19/69
D892,918 S 8/2020 Sugiyama et al.
D920,426 S 5/2021 Khubani et al.

OTHER PUBLICATIONS

Walmart. Link: <https://www.walmart.com/ip/Yungwalm-Identity-Theft-Protection-Roller-Stamp-Wide-Rolling-Address-Blocker-With-Lanyard-Pad-Ink-Confidential-Privacy-Data-Hiding-classy/1073085555?wmlspartner=wlp&selectedSellerId=101130307> Visited Oct. 4, 2022. Yungwalm Identity Theft Protection Roller Stamp (Year: 2022).*

Amazon. Link: https://www.amazon.com/StampMark-Identity-Theft-Protection-Roller/dp/B09V9TD9W2/ref=sr_1_18_sspa?keywords=Qweryboo+Identity+Theft+Protection+Roller+Stamp&qid=1664913340&sr=8-18-spons&psc=1&smid=A2QBOB6DJO04R4. Mar. 10, 2022. StampMark Identity Theft Protection Super Roller Stamp. (Year: 2022).*

Amazon. Link: https://www.amazon.com/Belioncry-Identity-Protection-Information-Security/dp/B09W9K7N2S/ref=sr_1_1?crid=18G7IQYNB2VE1&keywords=B09W9K7N2S&qid=1664983701&srefix=b09w9k7n2s%2Caps%2C119&sr=8-1. Mar. 25, 2022. Belioncry Identity Theft Protection Roller Stamp. (Year: 2022).*

* cited by examiner

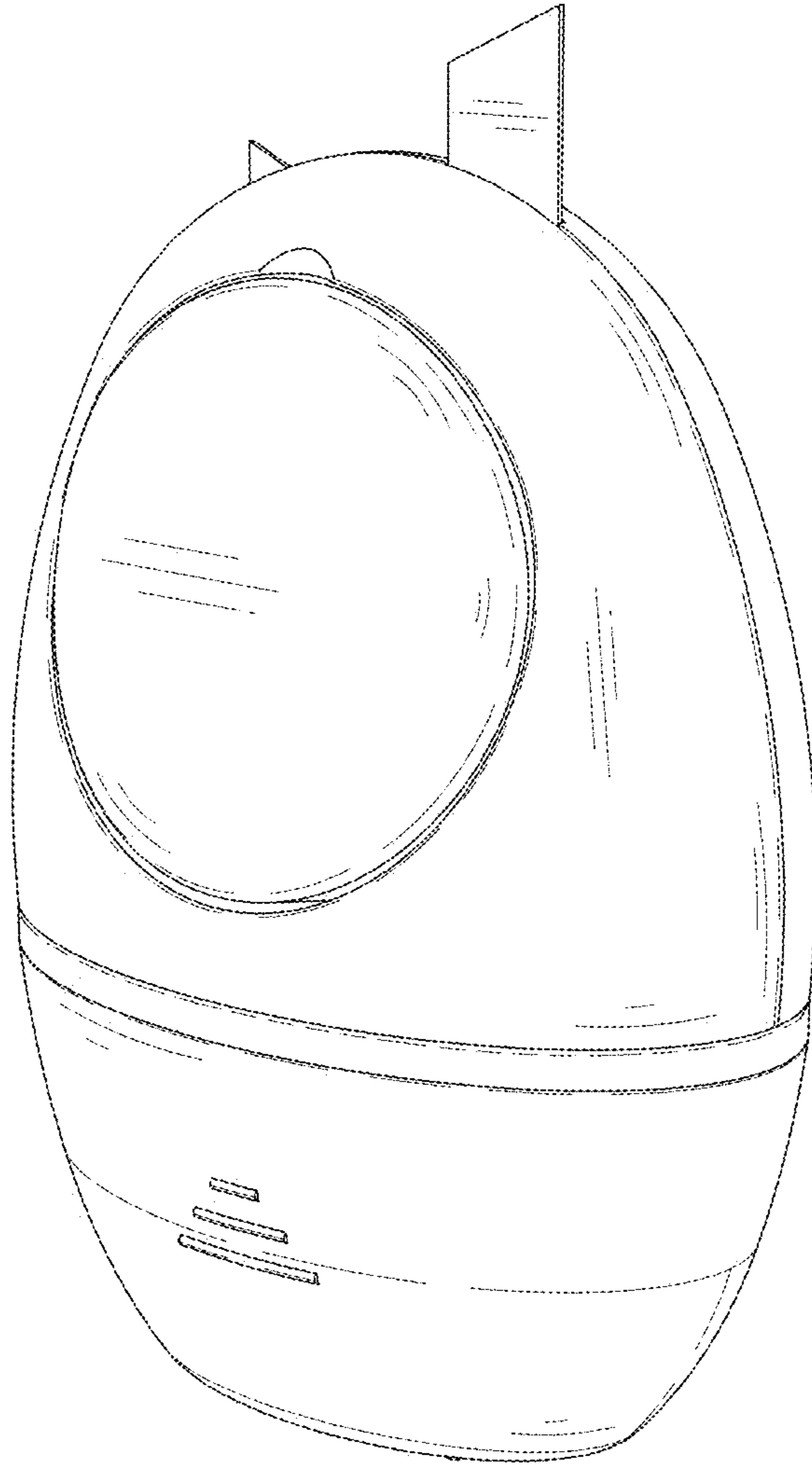

FIG. 1

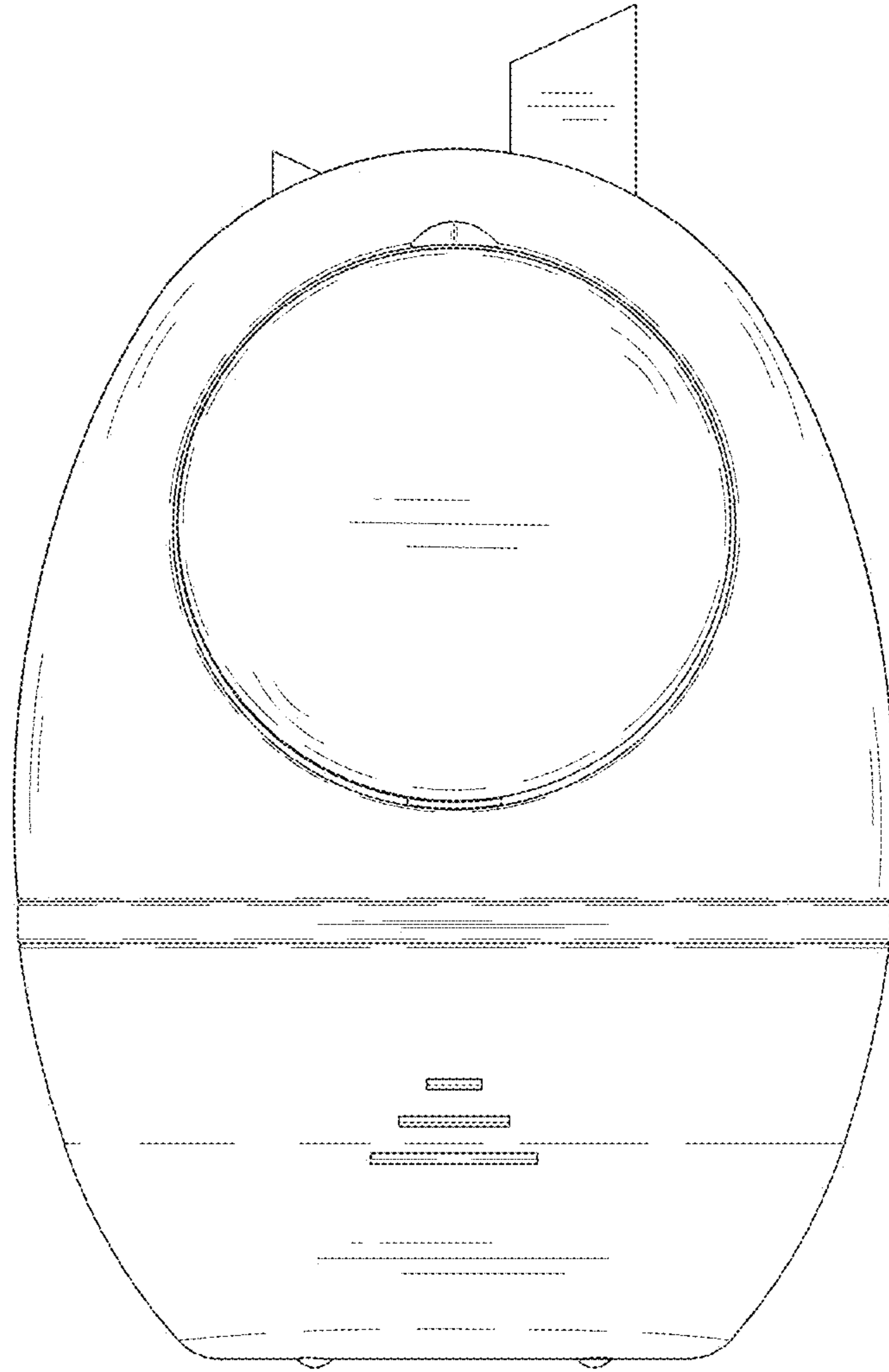

FIG. 2

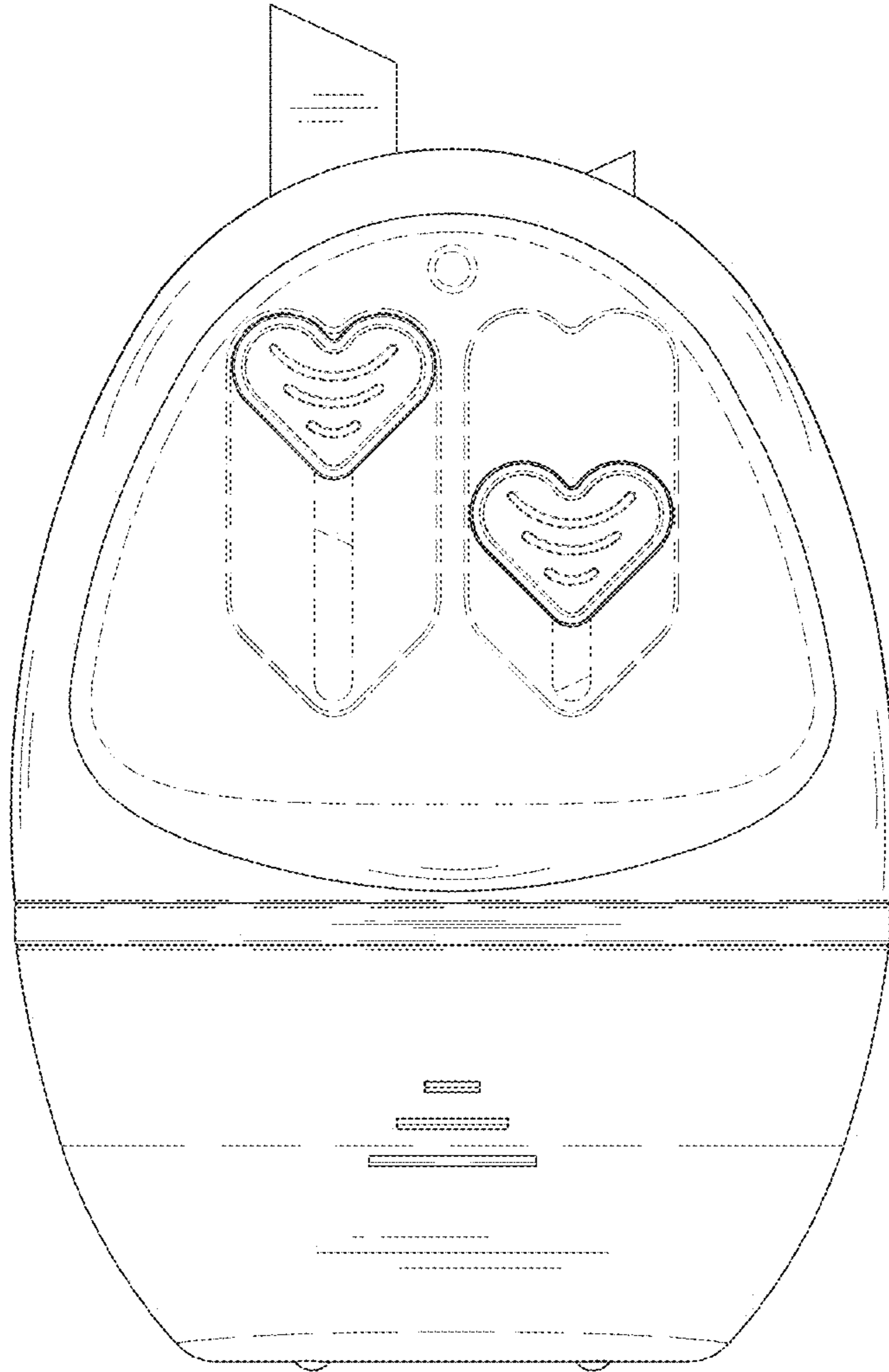

FIG. 3

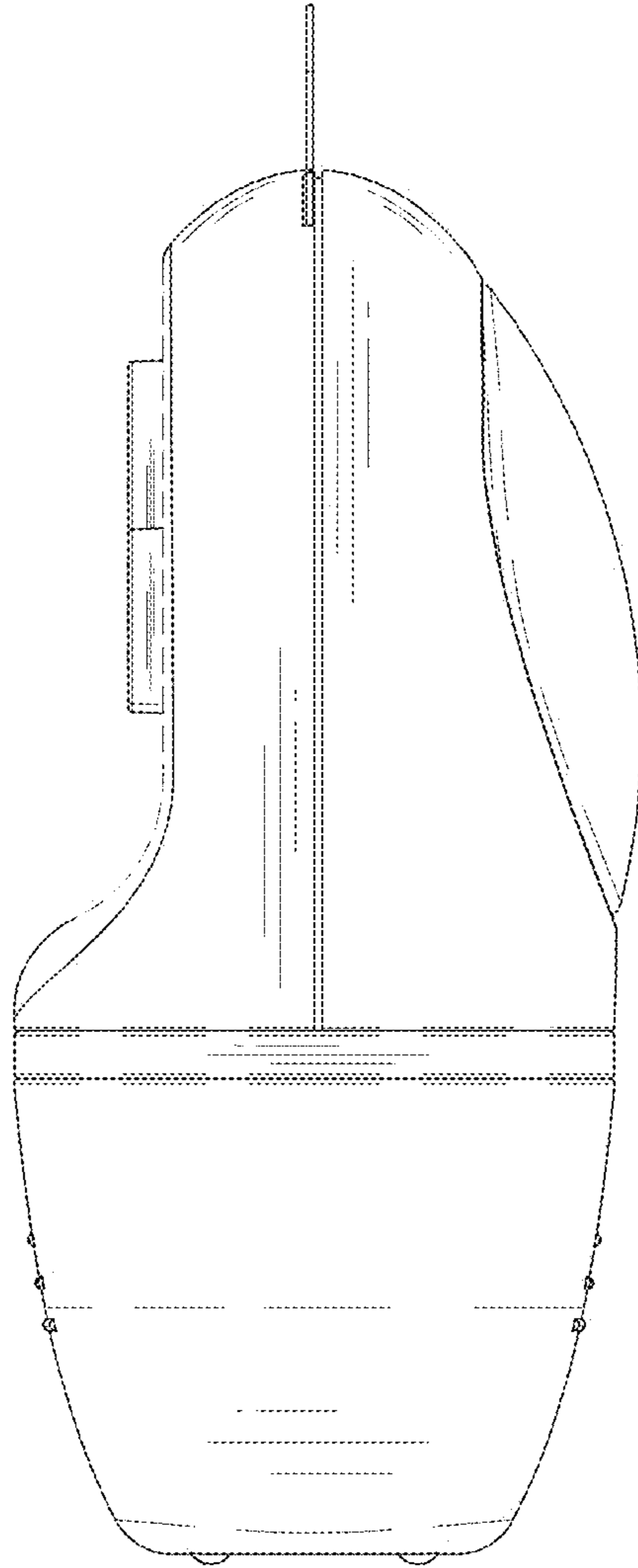

FIG. 4

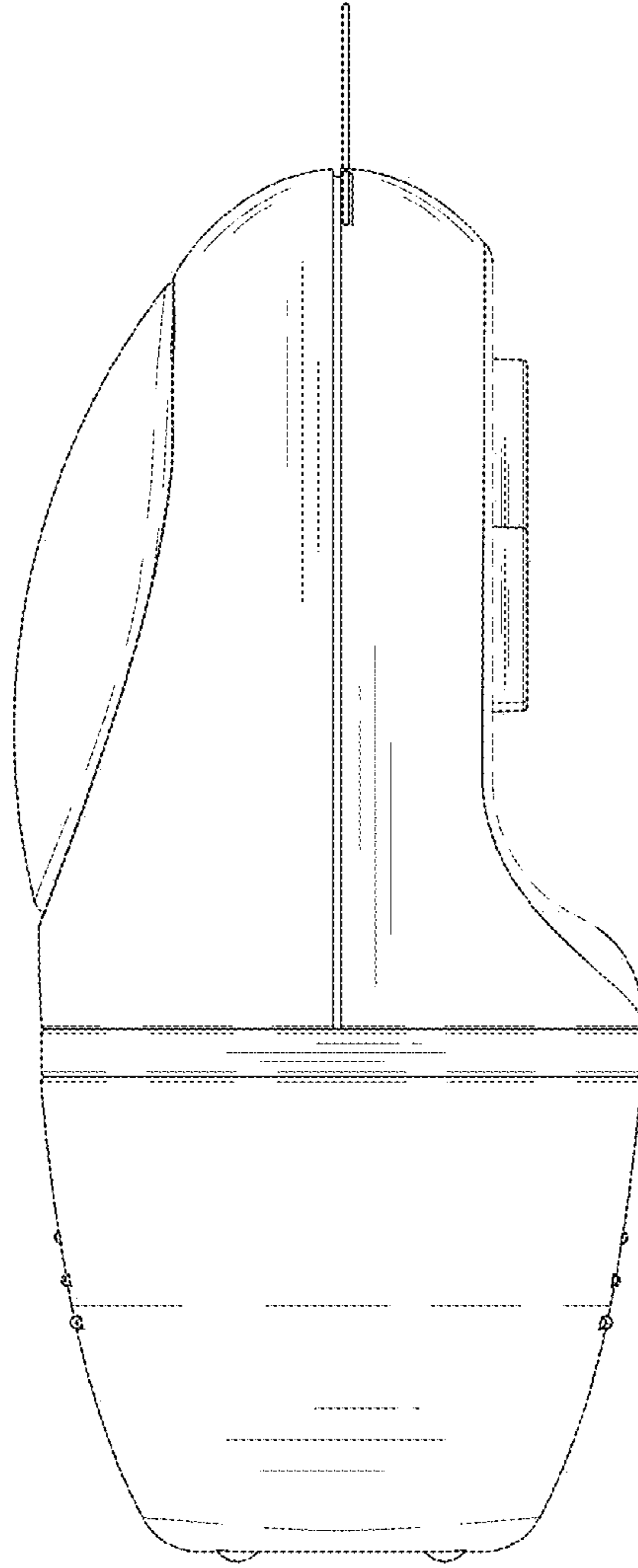

FIG. 5

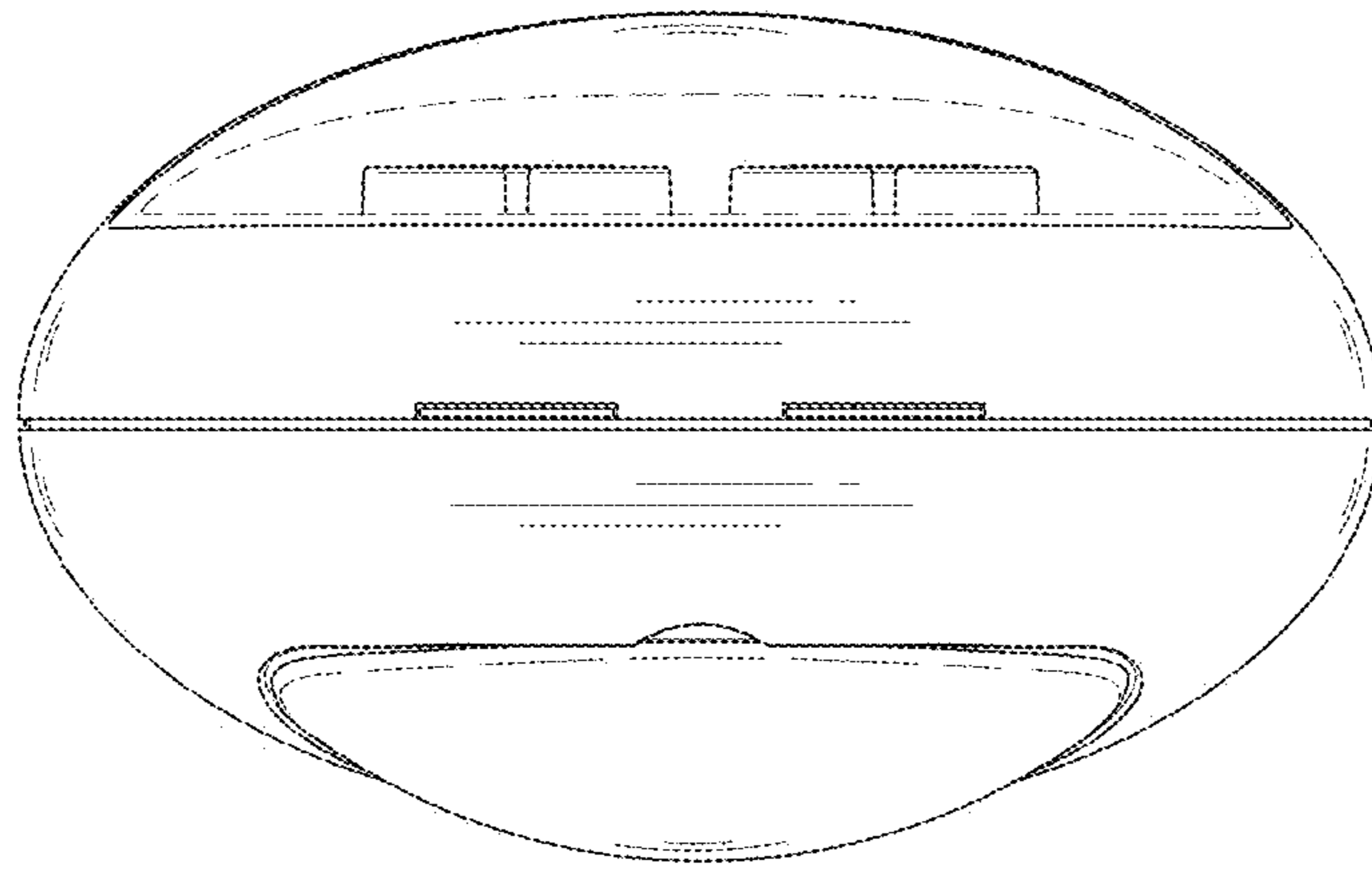

FIG. 6

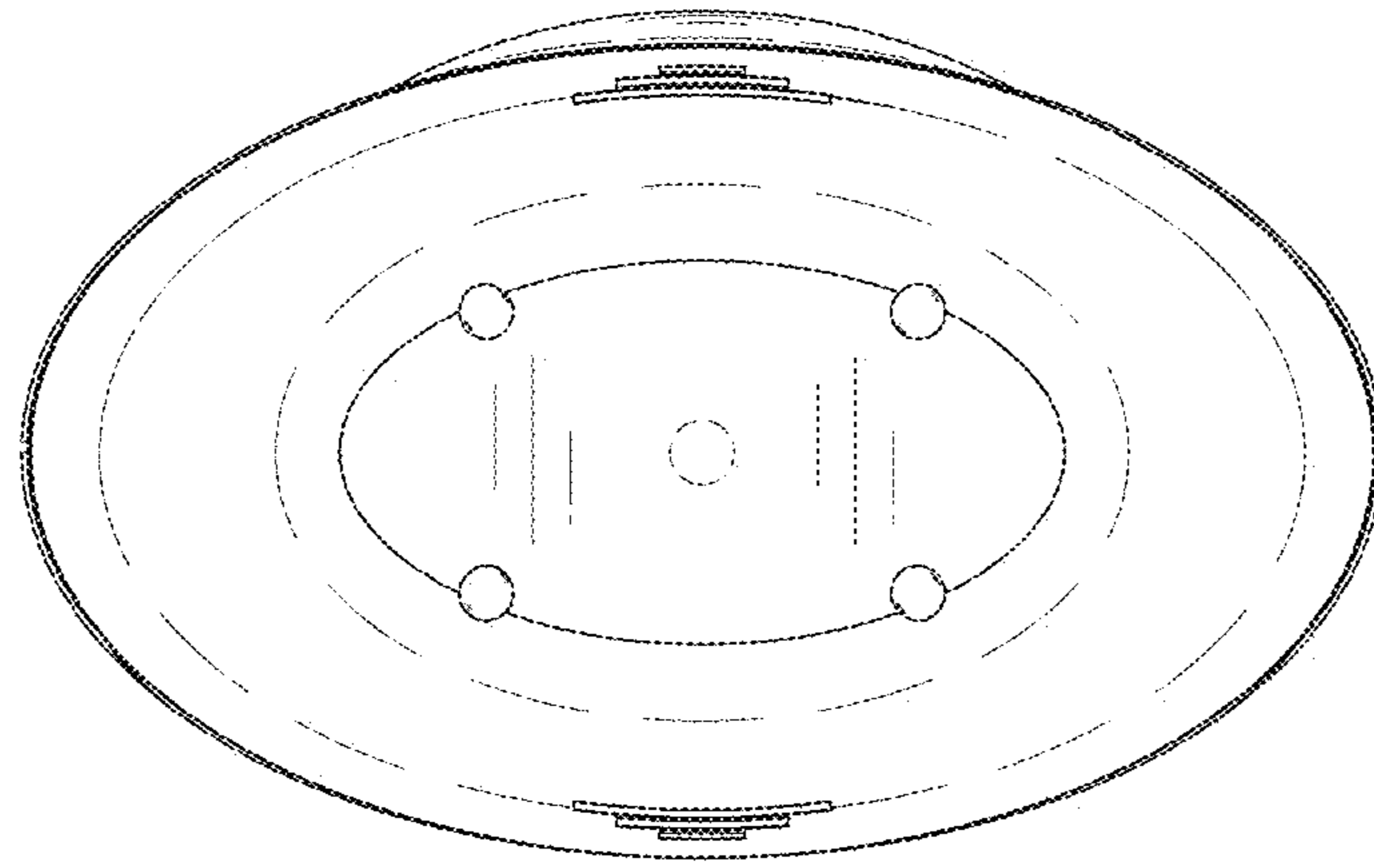

FIG. 7