



US00D980825S

(12) **United States Design Patent**
Levy et al.

(10) **Patent No.:** **US D980,825 S**
(45) **Date of Patent:** **** Mar. 14, 2023**

(54) **EARBUD**
(71) Applicant: **Navajo Manufacturing Company, Inc., Denver, CO (US)**
(72) Inventors: **Gordon Levy, Golden, CO (US); Shawn Shelton, Highlands Ranch, CO (US)**
(73) Assignee: **Navajo Manufacturing Company, Inc., Denver, CO (US)**
(**) Term: **15 Years**
(21) Appl. No.: **29/794,557**

D830,336 S * 10/2018 Cai D14/205
D832,824 S * 11/2018 Kim D14/223
D847,125 S * 4/2019 Akana D14/206
D847,794 S * 5/2019 Guo D14/223
D848,979 S * 5/2019 Kim D14/223
D848,982 S * 5/2019 Kim D14/223
D848,983 S * 5/2019 Kim D14/223
D849,401 S * 5/2019 Akana et al.
D861,647 S * 10/2019 Chen D14/223
D864,165 S * 10/2019 Roberts D14/223
D864,169 S * 10/2019 Min D14/223
D869,445 S * 12/2019 Hu D14/223
D878,045 S * 3/2020 Akana et al.
D878,337 S * 3/2020 Yang D14/223
D888,690 S * 6/2020 Yan D14/223
D889,436 S * 7/2020 Zhang D14/206

(Continued)

(22) Filed: **Jun. 14, 2021**
(51) **LOC (14) Cl.** **14-01**
(52) **U.S. Cl.**
USPC **D14/223**
(58) **Field of Classification Search**
USPC D14/223, 205; D3/274; D13/108;
D24/174; 128/864-866; 381/380-381
CPC H04R 1/10; H04R 25/00; H04R 25/02;
H04R 1/1066; H04R 1/1016; H04R
5/033; H04R 5/0335; H04R 1/105; H04R
1/1058; H04R 1/1091; H02J 7/02
See application file for complete search history.

FOREIGN PATENT DOCUMENTS

GB 9008305478-0001 * 12/2020

Primary Examiner — Paula Allen Greene

(74) *Attorney, Agent, or Firm* — Studebaker & Brackett PC

(57) **CLAIM**

The ornamental design for an earbud, as shown and described.

DESCRIPTION

FIG. 1 is a top perspective view showing our new design for an earbud,

FIG. 2 is a bottom perspective view thereof,

FIG. 3 is a front view thereof,

FIG. 4 is a rear view thereof,

FIG. 5 is a top view thereof,

FIG. 6 is a bottom view thereof,

FIG. 7 is a left side view thereof; and,

FIG. 8 is a right side view thereof.

The broken lines in the drawings depict portions of the an earbud that form no part of the claimed design.

1 Claim, 4 Drawing Sheets

(56) **References Cited**

U.S. PATENT DOCUMENTS

D687,418 S * 8/2013 Godfrey D14/223
D718,284 S * 11/2014 Shibusawa D14/223
D784,962 S * 4/2017 Yang D14/223
D801,312 S * 10/2017 Birger H04R 1/1066
D14/223
D801,314 S * 10/2017 Akana D14/223
D803,184 S * 11/2017 Loh Jun Kern D14/223
D806,388 S * 1/2018 Akana et al.
D818,268 S * 5/2018 Akana et al.
D821,362 S * 6/2018 Vaclavik D14/223
D822,009 S * 7/2018 Matoba D14/223

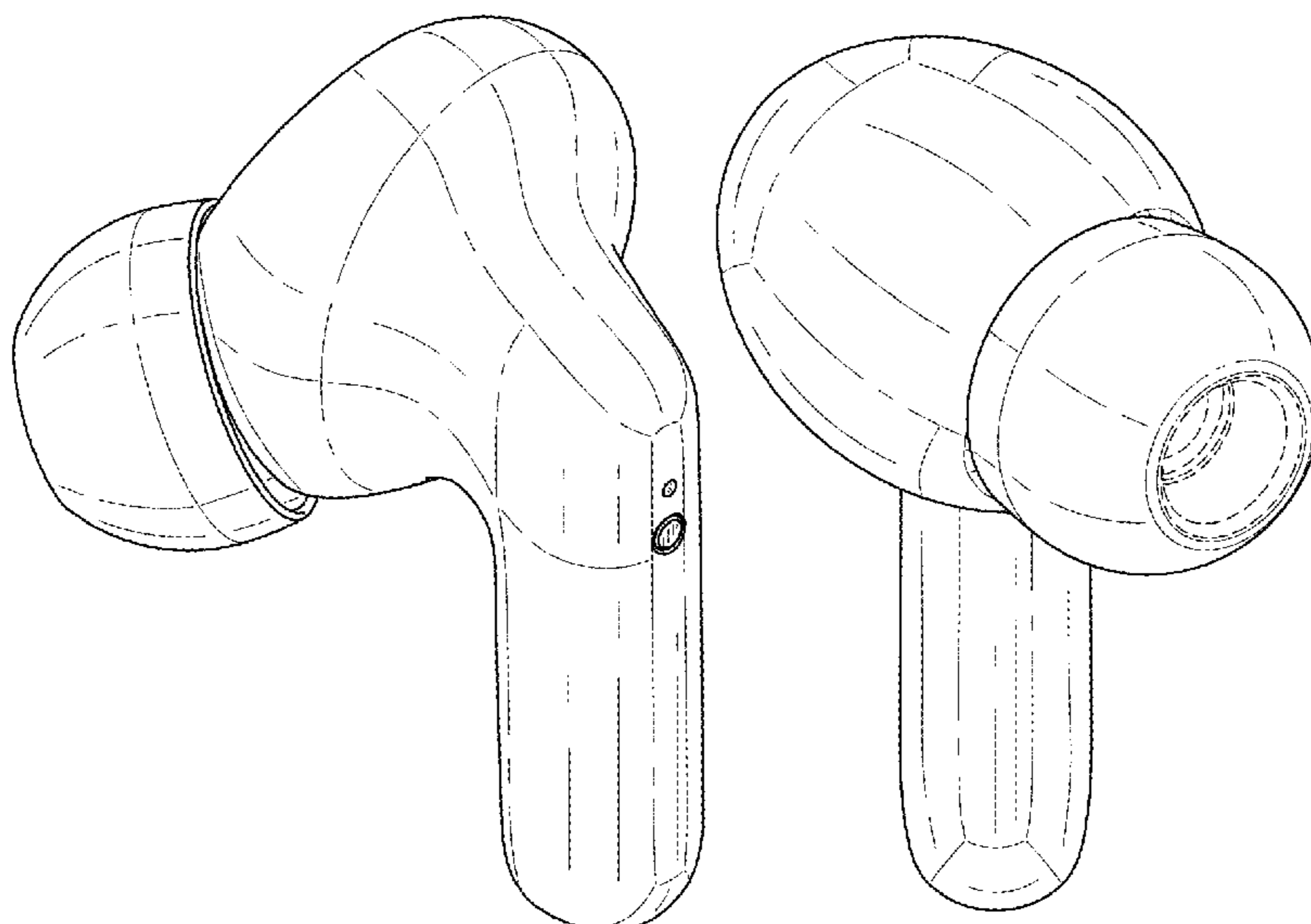

(56)

References Cited

U.S. PATENT DOCUMENTS

D889,440 S * 7/2020 Yan D14/223
 D890,138 S * 7/2020 Peng D14/223
 D893,462 S * 8/2020 Liu D14/223
 D894,875 S * 9/2020 Zhao D14/223
 D895,579 S * 9/2020 Yang D14/223
 D895,582 S * 9/2020 Wu D14/223
 D896,206 S * 9/2020 Xu D14/223
 D897,291 S 9/2020 Akana et al.
 D897,997 S * 10/2020 Zhang D14/223
 D897,998 S * 10/2020 Ma D14/223
 D903,639 S * 12/2020 Yang D14/223
 D904,351 S * 12/2020 Zhang D14/223
 D905,018 S * 12/2020 Zhu D14/223
 D907,008 S * 1/2021 Yao D14/223
 D907,607 S * 1/2021 Deng D14/223
 D910,600 S * 2/2021 Zhang D14/223
 D910,601 S * 2/2021 Hu D14/223
 D912,011 S * 3/2021 Zhao H04R 1/1041
 D912,017 S * 3/2021 Chen D14/223
 D915,355 S * 4/2021 Xiang D14/223
 D916,683 S * 4/2021 Yao D14/223

D918,178 S * 5/2021 Chen D14/223
 D918,179 S * 5/2021 Zhao D14/223
 D918,182 S * 5/2021 Chen D14/223
 D920,291 S * 5/2021 Hou D14/223
 D920,293 S * 5/2021 Chen D14/223
 D921,615 S * 6/2021 Wu D14/223
 D928,126 S * 8/2021 Chen D14/223
 D929,969 S * 9/2021 Ding D3/274
 D940,690 S * 1/2022 Zhang D14/223
 D942,424 S * 2/2022 Ye D14/223
 D948,482 S * 4/2022 Liu D14/223
 D950,525 S * 5/2022 Chen D14/223
 D955,369 S * 6/2022 Zhang D14/223
 D956,720 S * 7/2022 Huang D14/223
 D957,367 S * 7/2022 Sun D14/223
 2016/0205458 A1 * 7/2016 Huang H04R 1/1016
 381/380
 2020/0252715 A1 * 8/2020 Zhou H04R 1/1016
 2020/0304898 A1 * 9/2020 Cohen H04R 1/02
 2020/0382856 A1 * 12/2020 Liu H04R 1/2826
 2021/0084402 A1 * 3/2021 Terlizzi H04R 1/1041
 2021/0120328 A1 * 4/2021 Hedh H04R 1/1041
 2021/0266653 A1 * 8/2021 Cao H04R 1/1075
 2022/0286768 A1 * 9/2022 Chen H04R 29/001

* cited by examiner

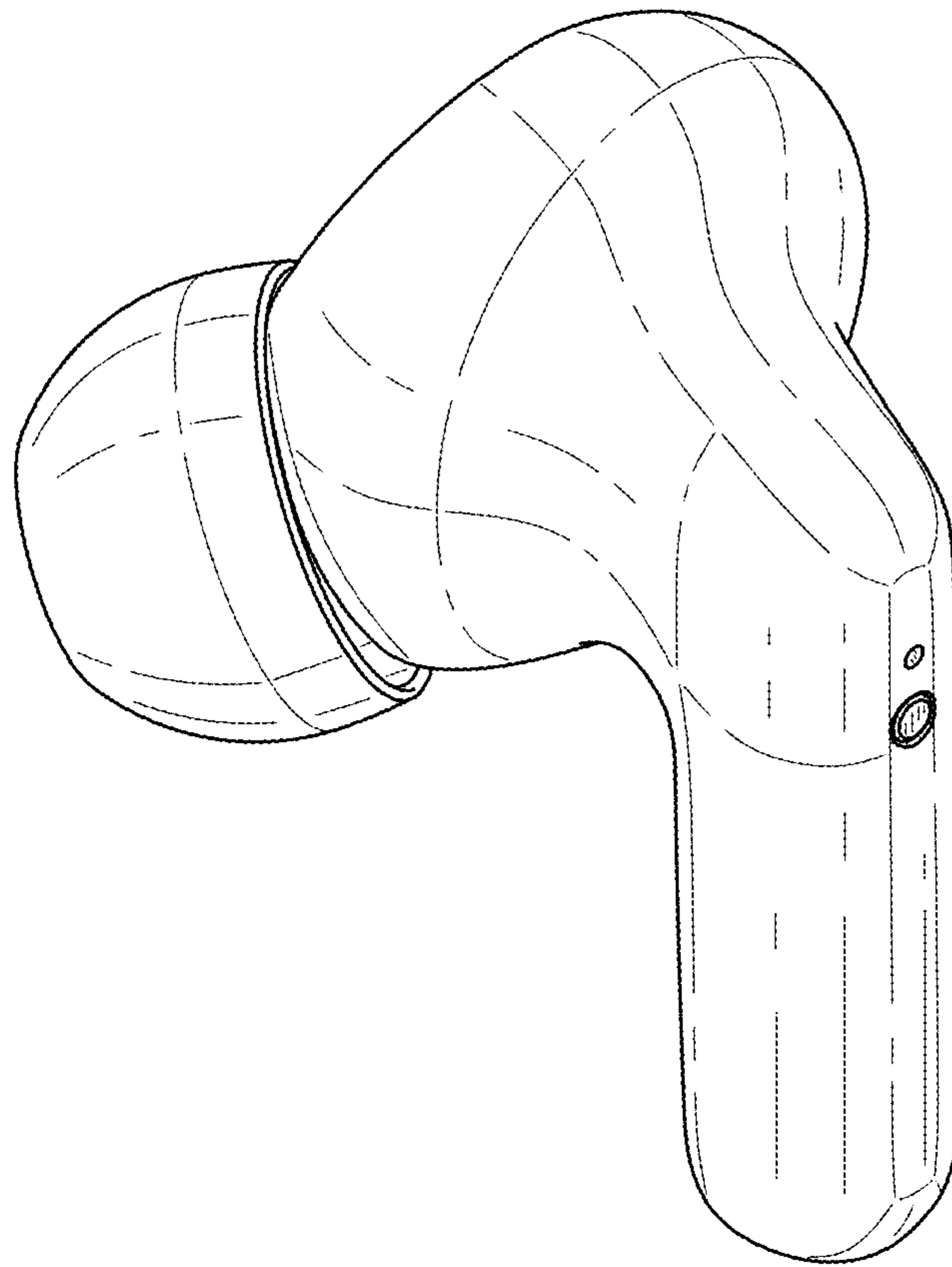

FIG. 1

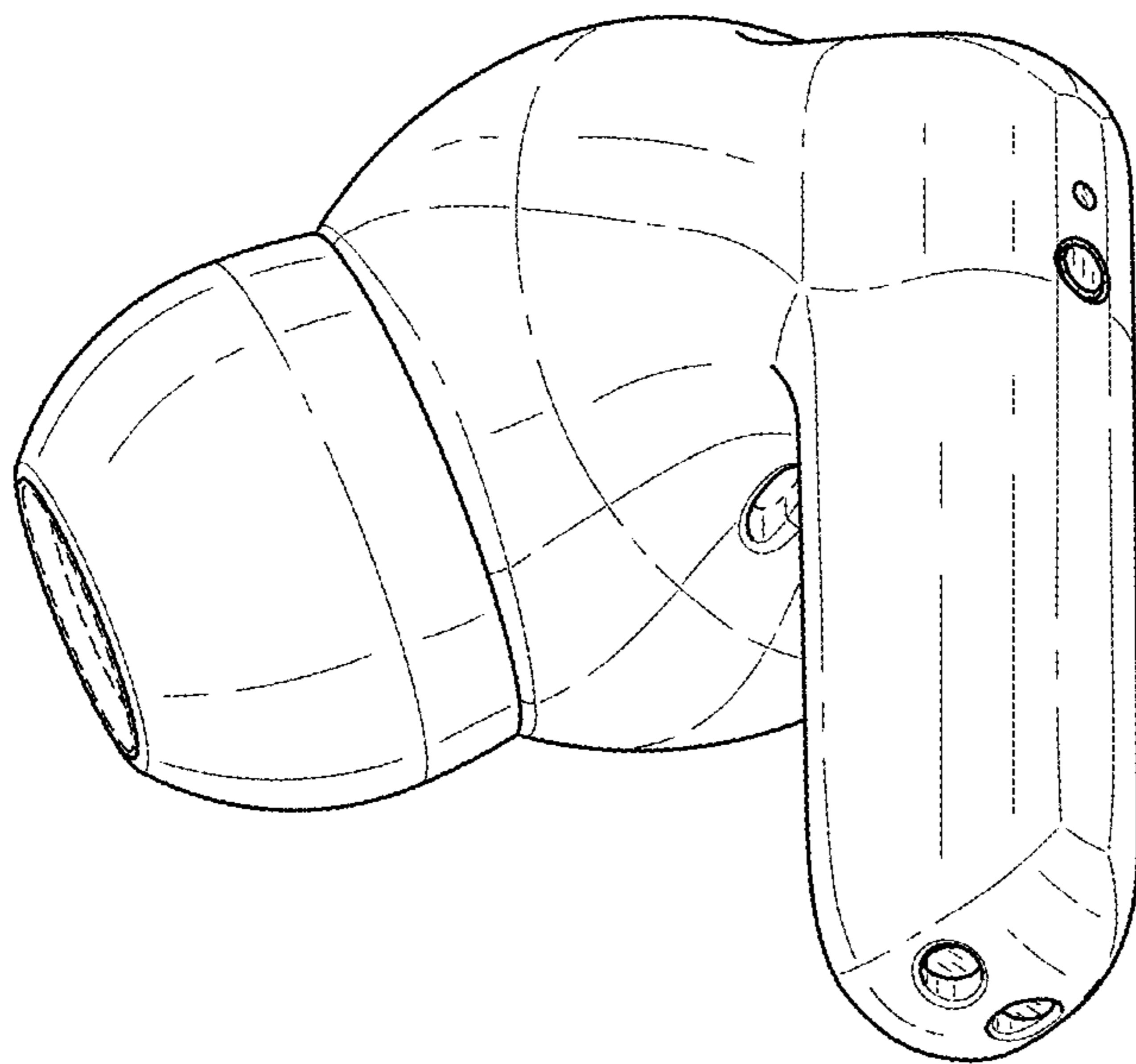

FIG. 2

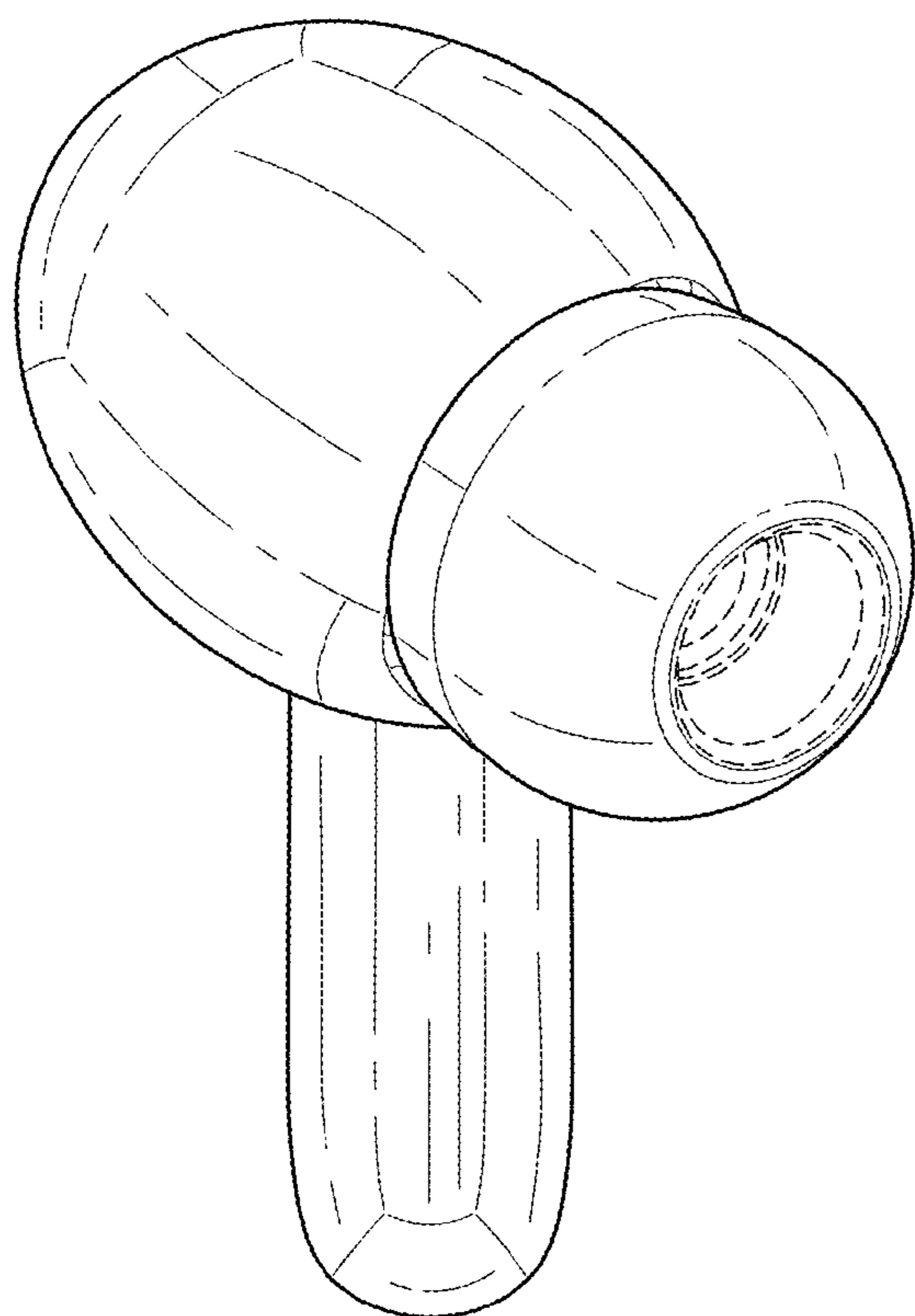

FIG. 3

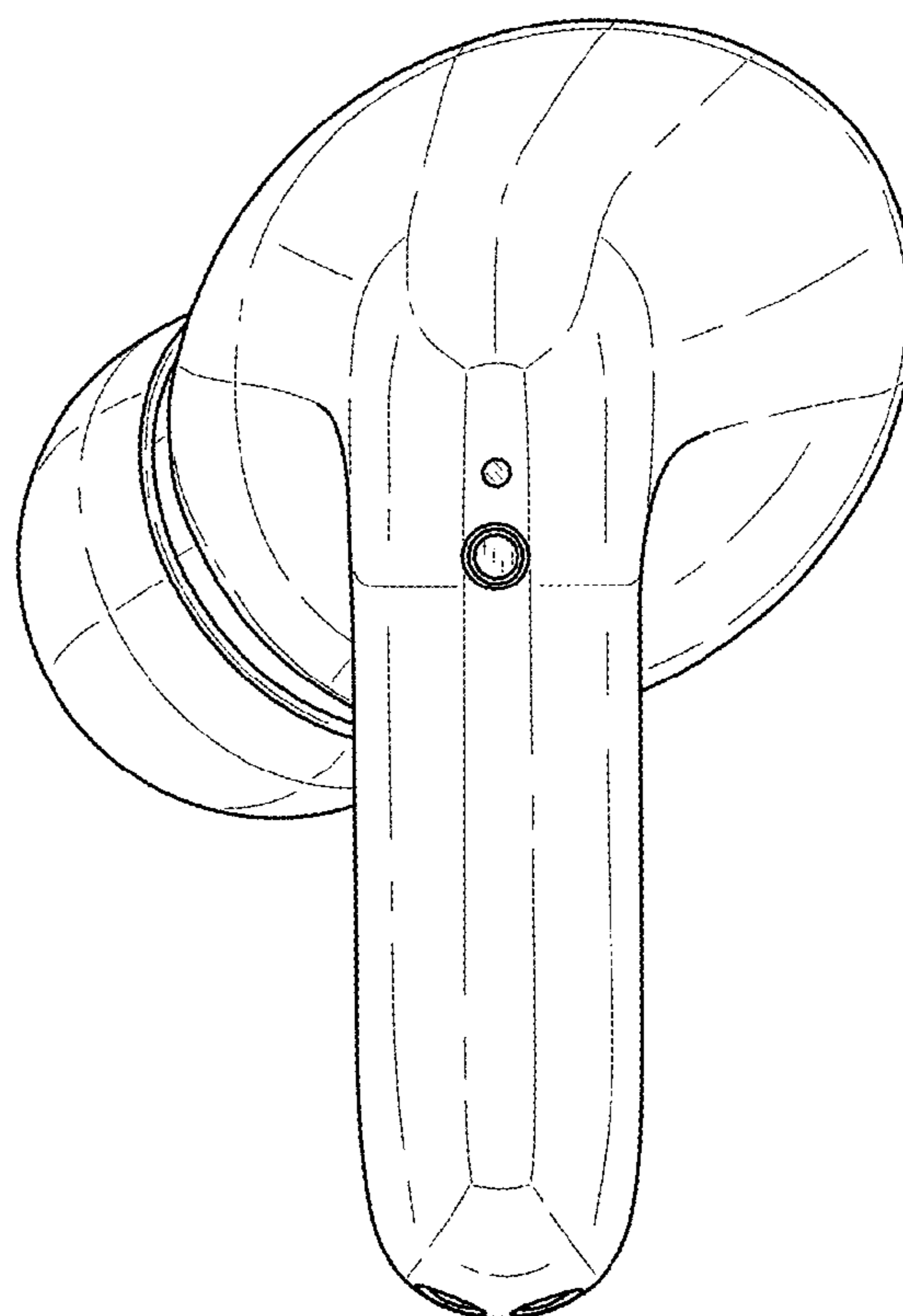

FIG. 4

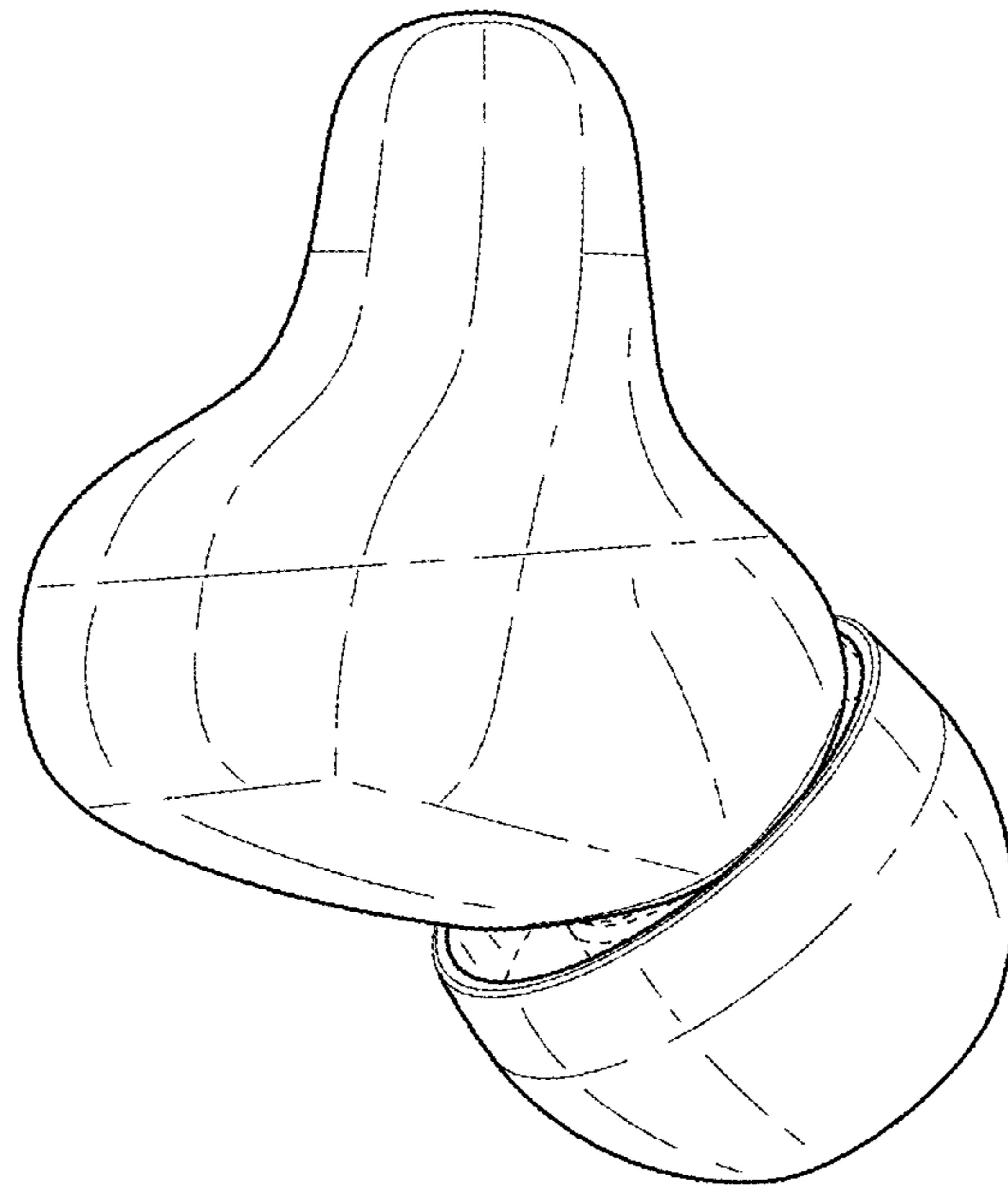

FIG. 5

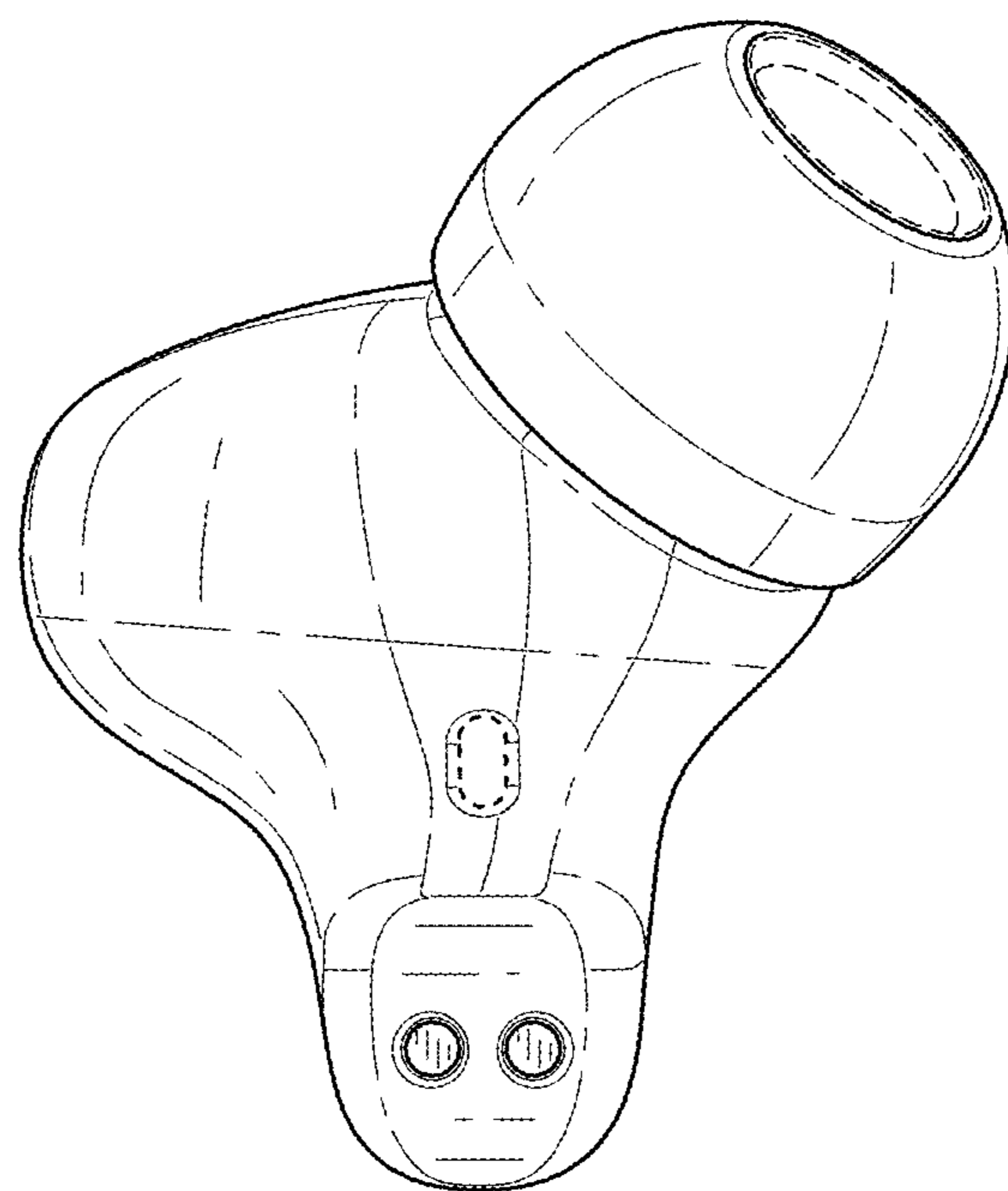

FIG. 6

FIG. 7

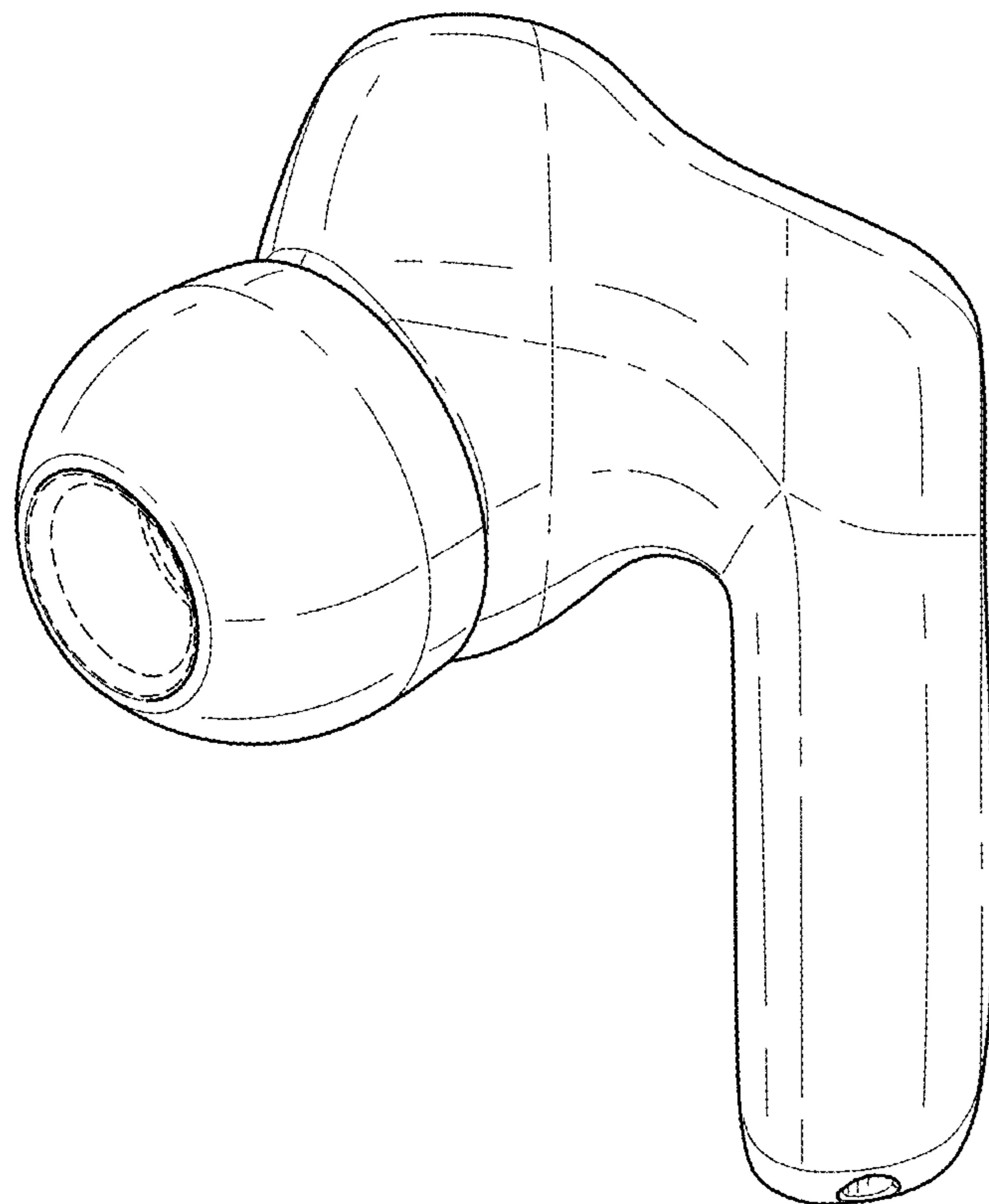
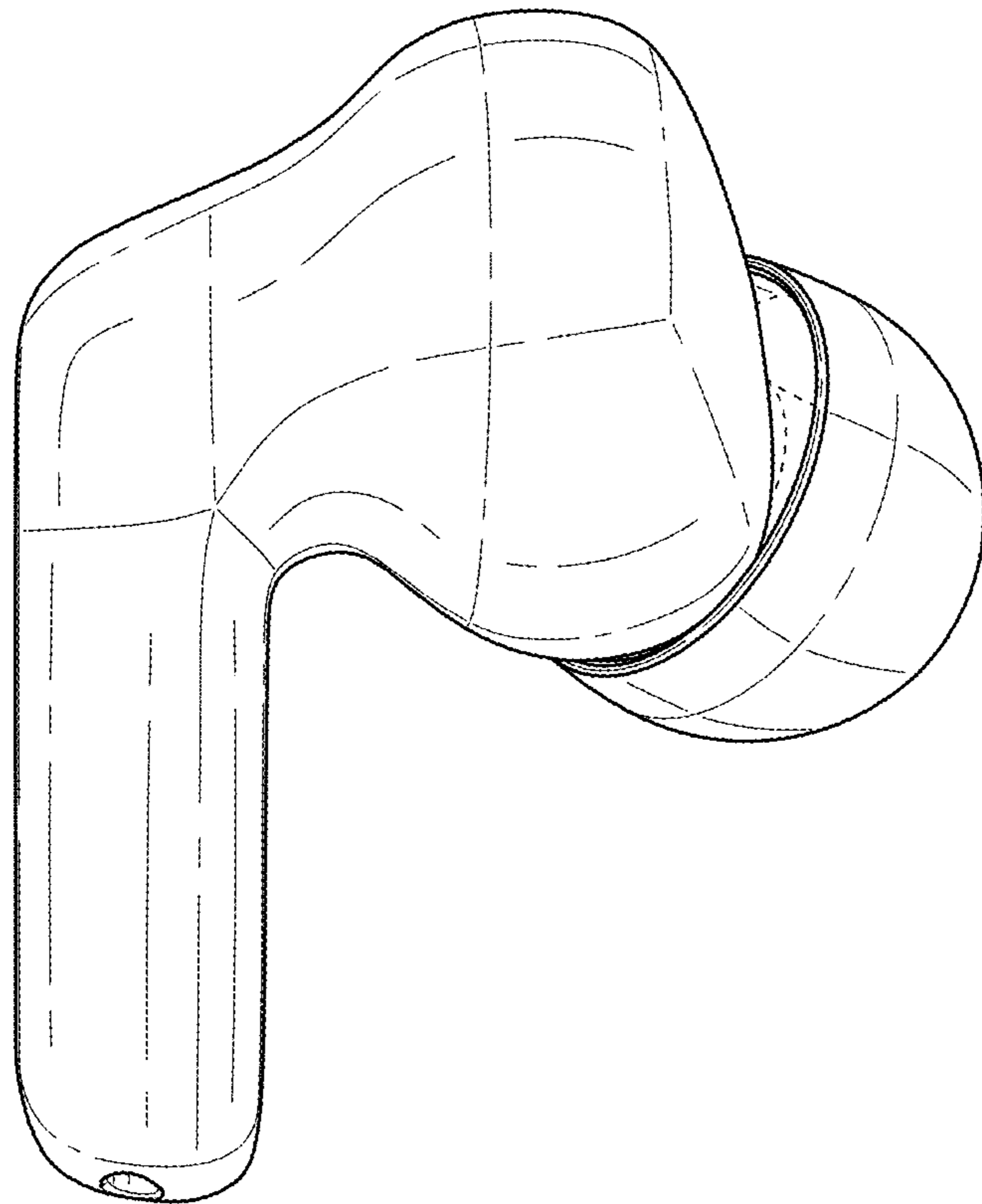

FIG. 8