



US00D980695S

(12) **United States Design Patent**
Martin

(10) **Patent No.:** **US D980,695 S**

(45) **Date of Patent:** **** Mar. 14, 2023**

(54) **PLAYGROUND TRACK RIDE MODULE**

(71) Applicant: **Richard Martin**, Plantagenet (CA)

(72) Inventor: **Richard Martin**, Plantagenet (CA)

(**) Term: **15 Years**

(21) Appl. No.: **29/832,831**

(22) Filed: **Mar. 30, 2022**

Related U.S. Application Data

(62) Division of application No. 29/693,946, filed on Jun. 6, 2019, now Pat. No. Des. 960,686.

(51) **LOC (14) Cl.** **08-05**

(52) **U.S. Cl.**
USPC **D8/354**; D21/814

(58) **Field of Classification Search**
USPC D8/354; D21/811, 814, 830
CPC ... A63G 3/00; A63G 1/12; A63G 1/08; A63G
9/00-08

See application file for complete search history.

(56) **References Cited**

U.S. PATENT DOCUMENTS

D334,788 S *	4/1993	Blankenagel	D21/830
D336,503 S *	6/1993	Hernandez, Jr.	D21/830
D379,486 S *	5/1997	Mariol	D21/814
D381,057 S *	7/1997	Strawcutter	D25/127
D462,889 S *	9/2002	Wright, Sr.	D8/355
D568,434 S *	5/2008	Wingerstahn	D21/811
D667,514 S *	9/2012	Pribelyi	D21/678

D696,372 S *	12/2013	Martin	D21/830
D697,572 S *	1/2014	Martin	D21/830
D728,052 S *	4/2015	Smith	D21/811
D960,686 S *	8/2022	Martin	D21/814

* cited by examiner

Primary Examiner — Keli L Hill

Assistant Examiner — Harold E Blackwell, II

(74) *Attorney, Agent, or Firm* — Amster, Rothstein & Ebenstein LLP

(57) **CLAIM**

The ornamental design for a playground track ride module, as shown and described.

DESCRIPTION

FIG. 1 is a perspective view of a playground track ride module showing the new design;
 FIG. 2 is a top plan thereof;
 FIG. 3 is a front view thereof;
 FIG. 4 is a right side elevational view thereof;
 FIG. 5 is a left side elevational view thereof;
 FIG. 6 is a rear view thereof;
 FIG. 7 is a bottom view thereof; and,
 FIG. 8 is a perspective view of the playground track ride module shown in an alternate environment.
 The broken line showing of the playground track ride module is for the purpose of illustrating environmental structure and forms no part of the claimed design.

1 Claim, 6 Drawing Sheets

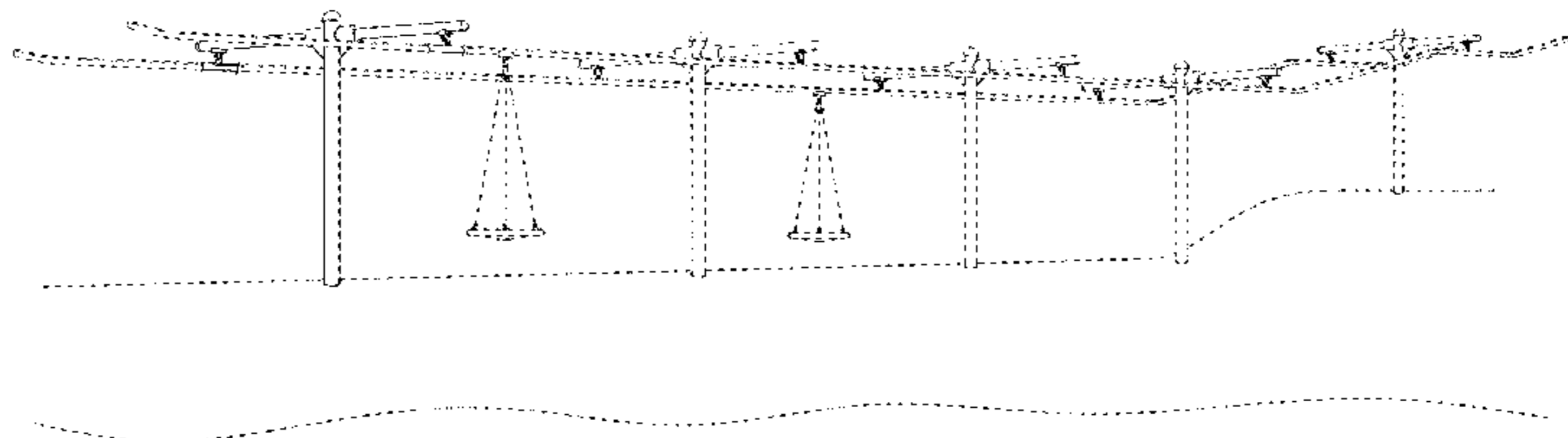
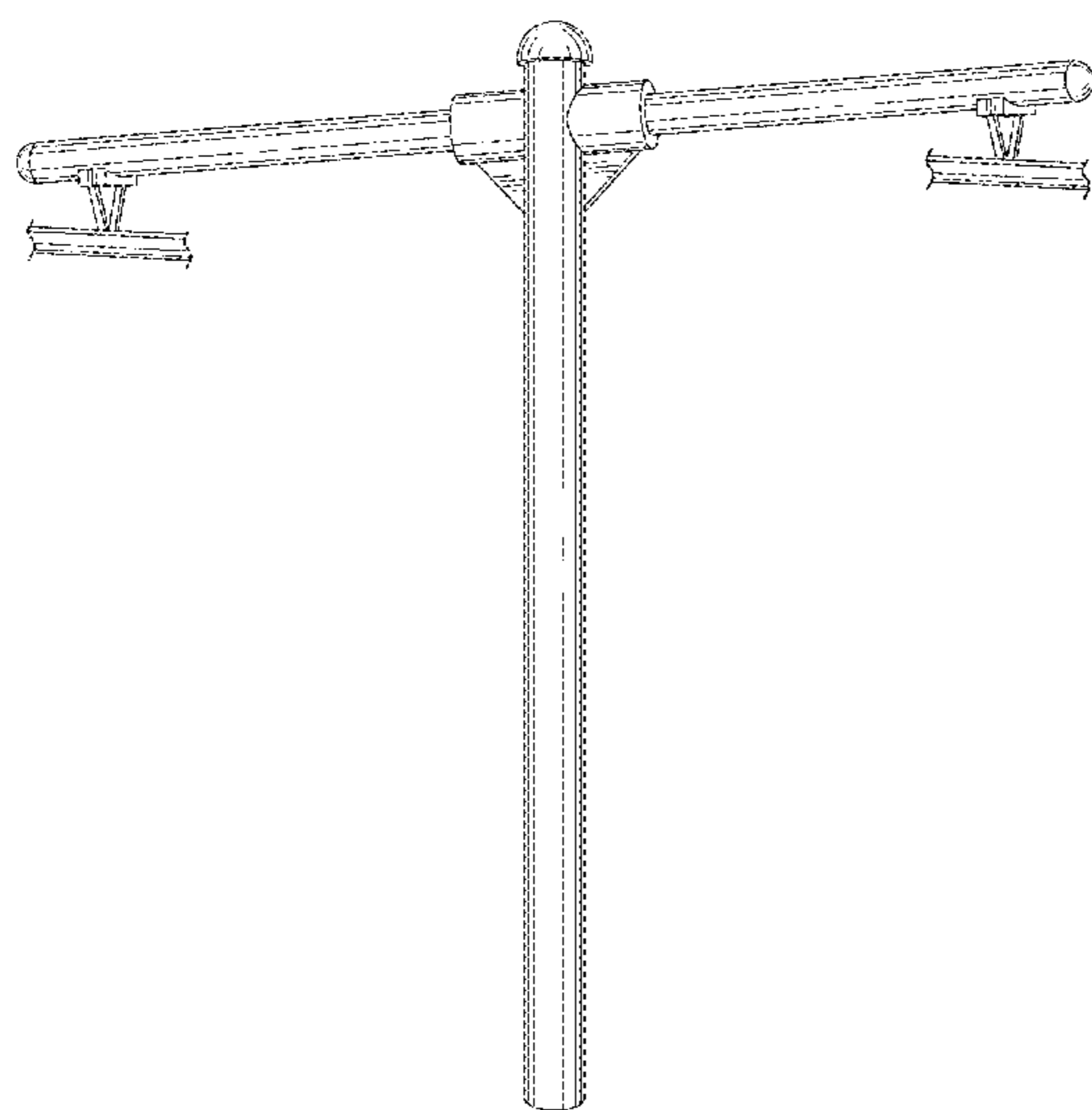

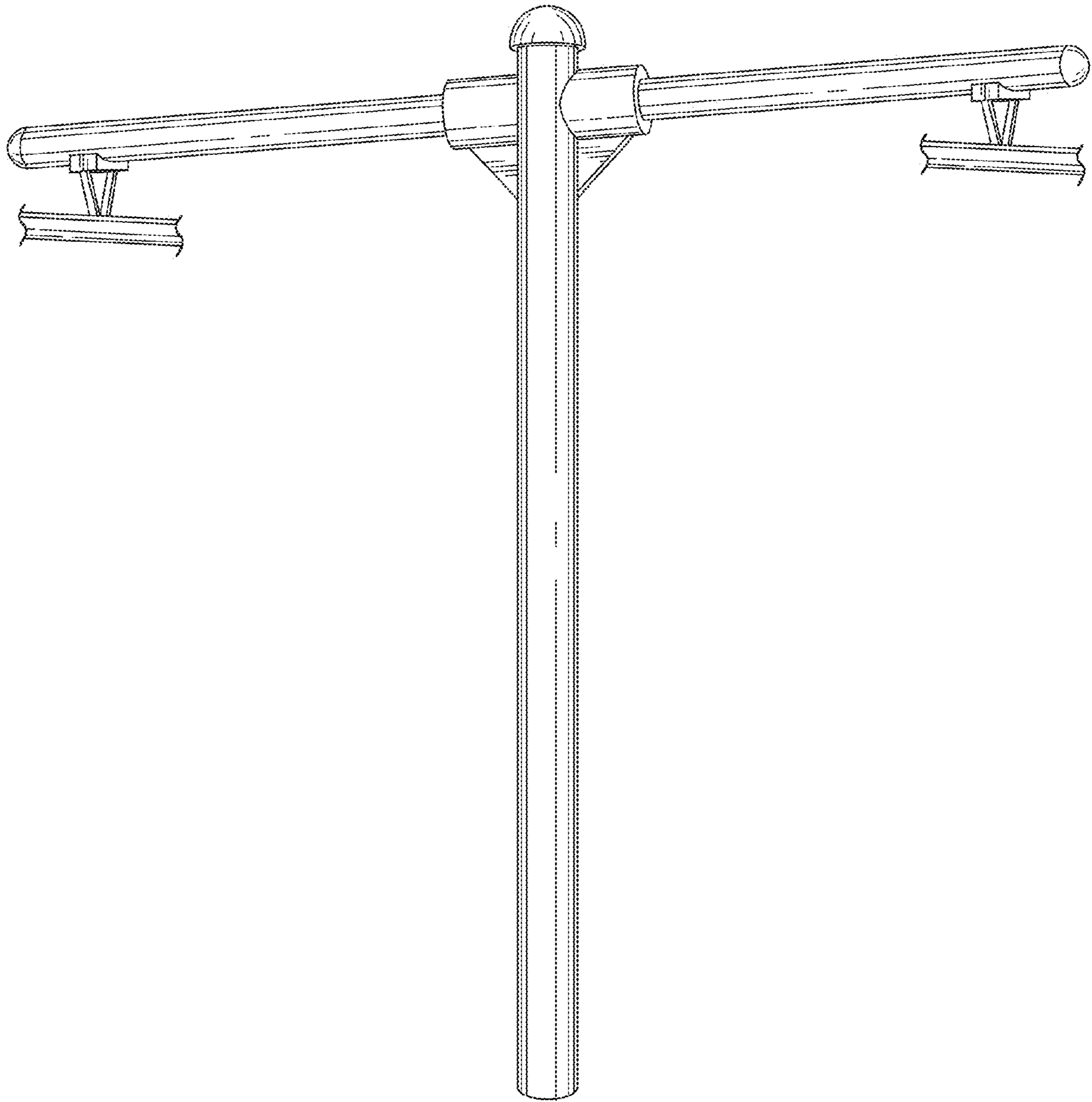

FIG. 1

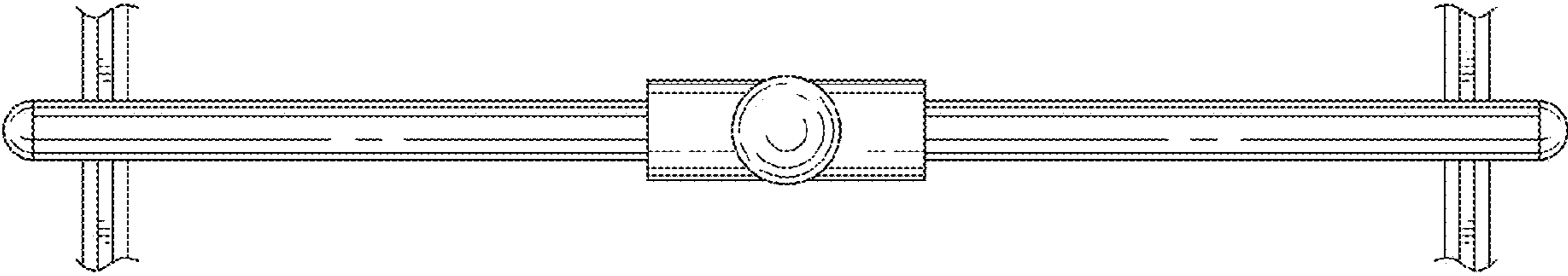

FIG. 2

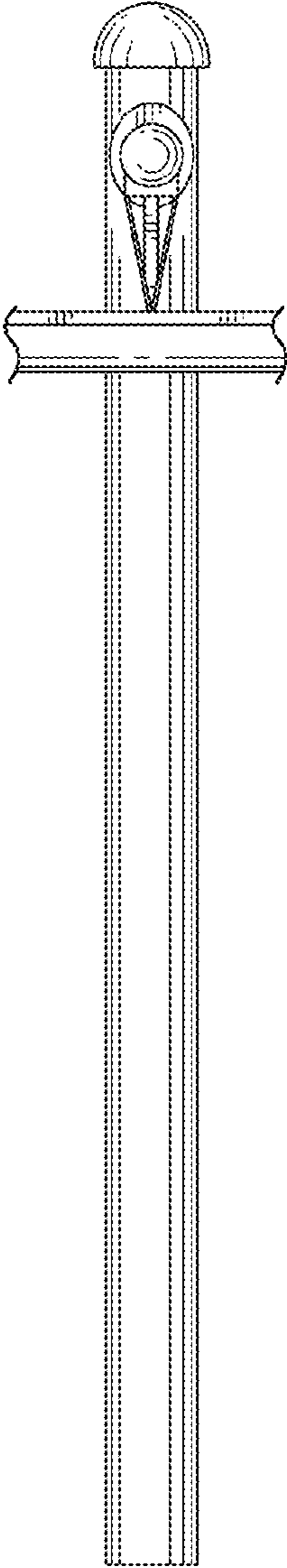

FIG. 3

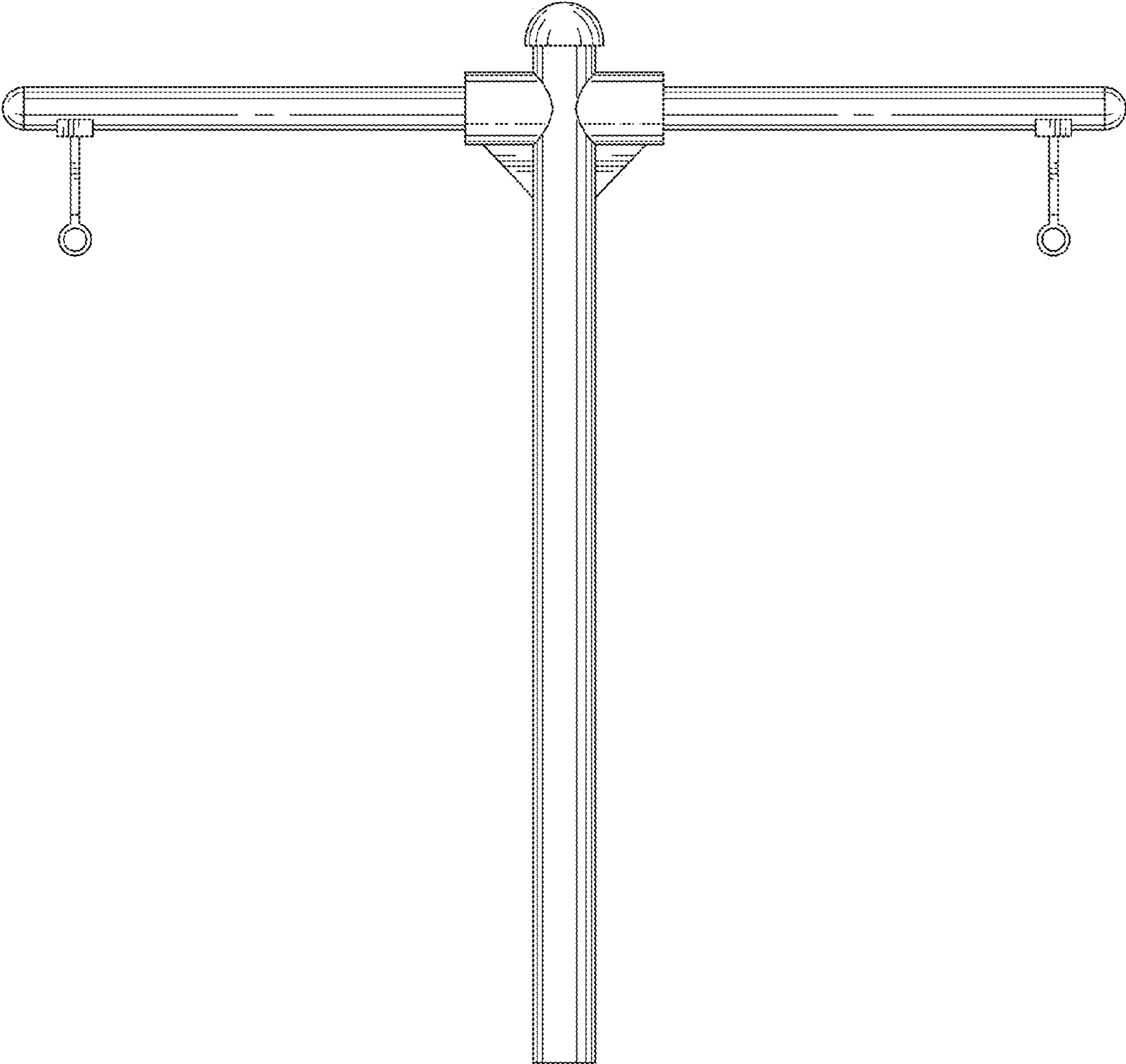

FIG. 4

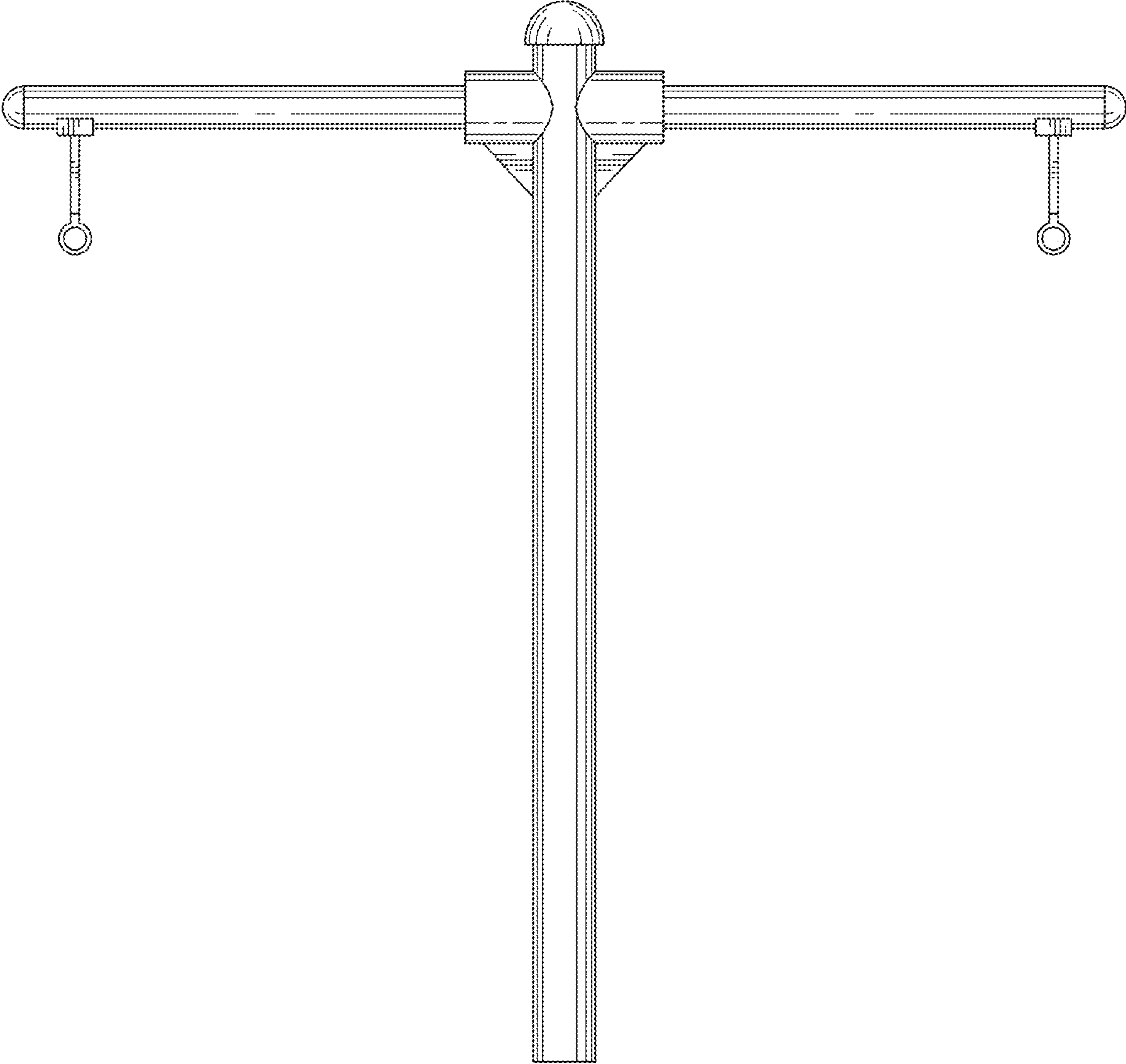

FIG. 5

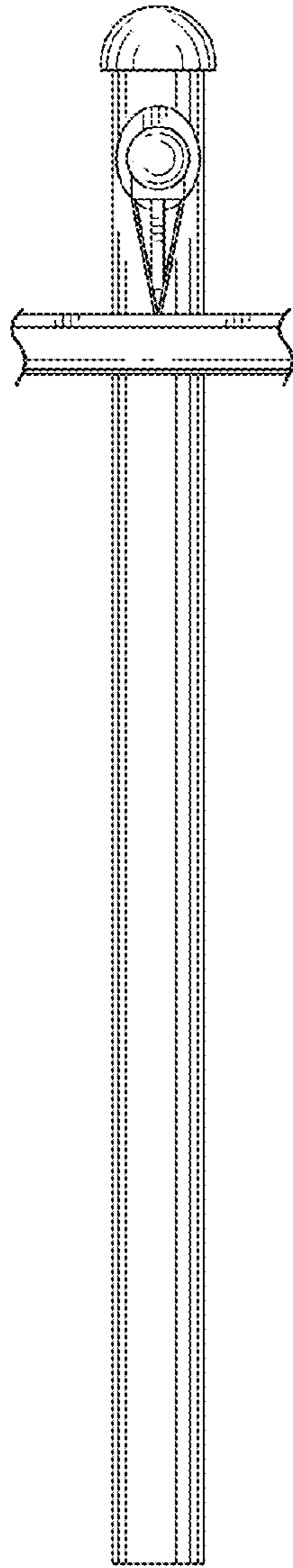

FIG. 6

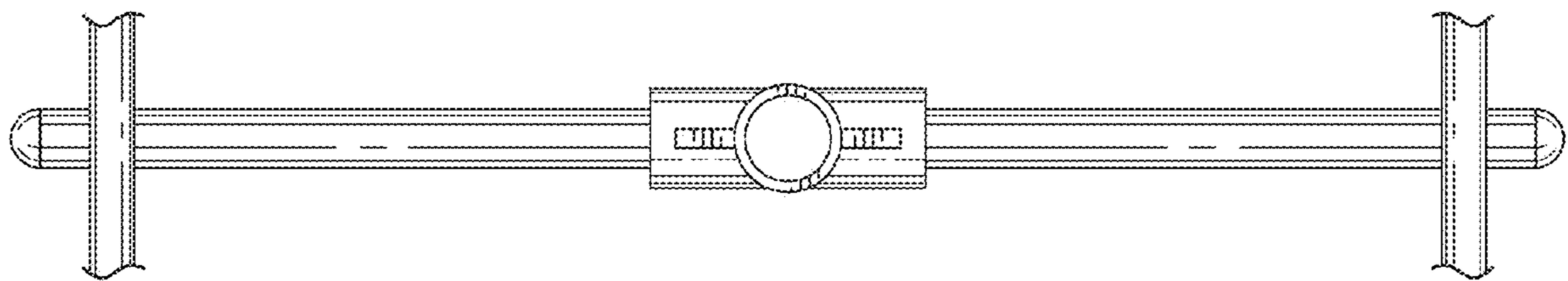

FIG. 7

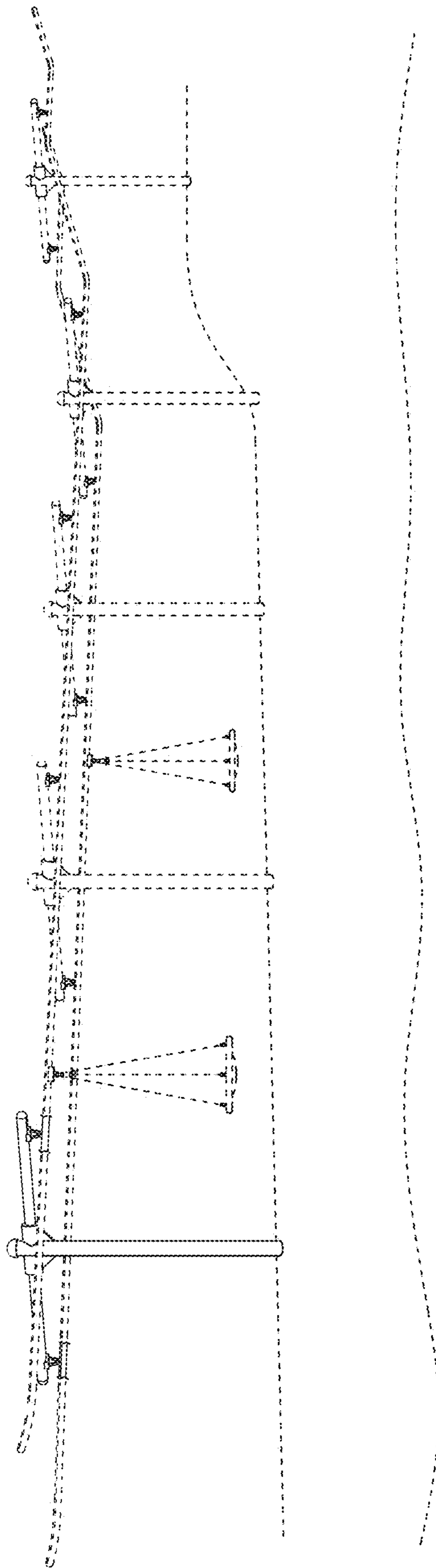

FIG. 8