



US00D980688S

(12) **United States Design Patent**
Yang

(10) **Patent No.:** **US D980,688 S**

(45) **Date of Patent:** **** Mar. 14, 2023**

(54) **PORTABLE TOOL**

(71) Applicant: **Ming Yang**, Calgary (CA)

(72) Inventor: **Ming Yang**, Calgary (CA)

(**) Term: **15 Years**

(21) Appl. No.: **29/786,240**

(22) Filed: **May 30, 2021**

(30) **Foreign Application Priority Data**

May 3, 2021 (CN) 202130263752.8

(51) **LOC (14) Cl.** **08-05**

(52) **U.S. Cl.**
USPC **D8/105**

(58) **Field of Classification Search**
USPC D8/14, 26, 34, 41, 55, 93, 98, 99, 104,
D8/105, 89; D21/532
CPC B25F 1/00; B25F 1/003; B25F 1/02; B25B
7/22
See application file for complete search history.

(56) **References Cited**

U.S. PATENT DOCUMENTS

- 342,128 A * 5/1886 Parker B26B 11/00
7/138
- 354,313 A * 12/1886 Galloway B25B 7/22
81/304
- 888,795 A * 5/1908 Fields B26B 11/00
7/118
- D57,157 S * 2/1921 Schwendner D8/55
- D137,408 S * 3/1944 Frisk 7/129
- D319,767 S * 9/1991 Sargent D8/99
- D455,939 S * 4/2002 Allen D8/22

- D562,101 S * 2/2008 Martone D8/89
- D577,978 S * 10/2008 Chen D8/89
- D966,845 S * 10/2022 Pan D8/40
- 2016/0115007 A1 * 4/2016 Liou B25F 1/00
7/166
- 2019/0299371 A1 * 10/2019 Chern B25B 13/08

* cited by examiner

Primary Examiner — Calvin E Vansant

Assistant Examiner — Benjamin Lucas Gray

(74) *Attorney, Agent, or Firm* — Raymond Y. Chan;

David and Raymond Patent Firm

(57) **CLAIM**

The ornamental design for a portable tool, as shown and as described.

DESCRIPTION

FIG. 1 is a perspective view showing my new design.
 FIG. 2 is a front view of FIG. 1.
 FIG. 3 is a rear view of FIG. 1.
 FIG. 4 is a left end view of FIG. 1.
 FIG. 5 is a right end view of FIG. 1.
 FIG. 6 is a top view of FIG. 1.
 FIG. 7 is a bottom view of FIG. 1.
 FIG. 8 is a perspective view showing my new design while the clamp head and the knife blade thereof are unfolded.
 FIG. 9 is a front view of FIG. 8.
 FIG. 10 is a rear view of FIG. 8.
 FIG. 11 is a left end view of FIG. 8.
 FIG. 12 is a right end view of FIG. 8.
 FIG. 13 is a top view of FIG. 8; and,
 FIG. 14 is a bottom view of FIG. 8.

1 Claim, 12 Drawing Sheets

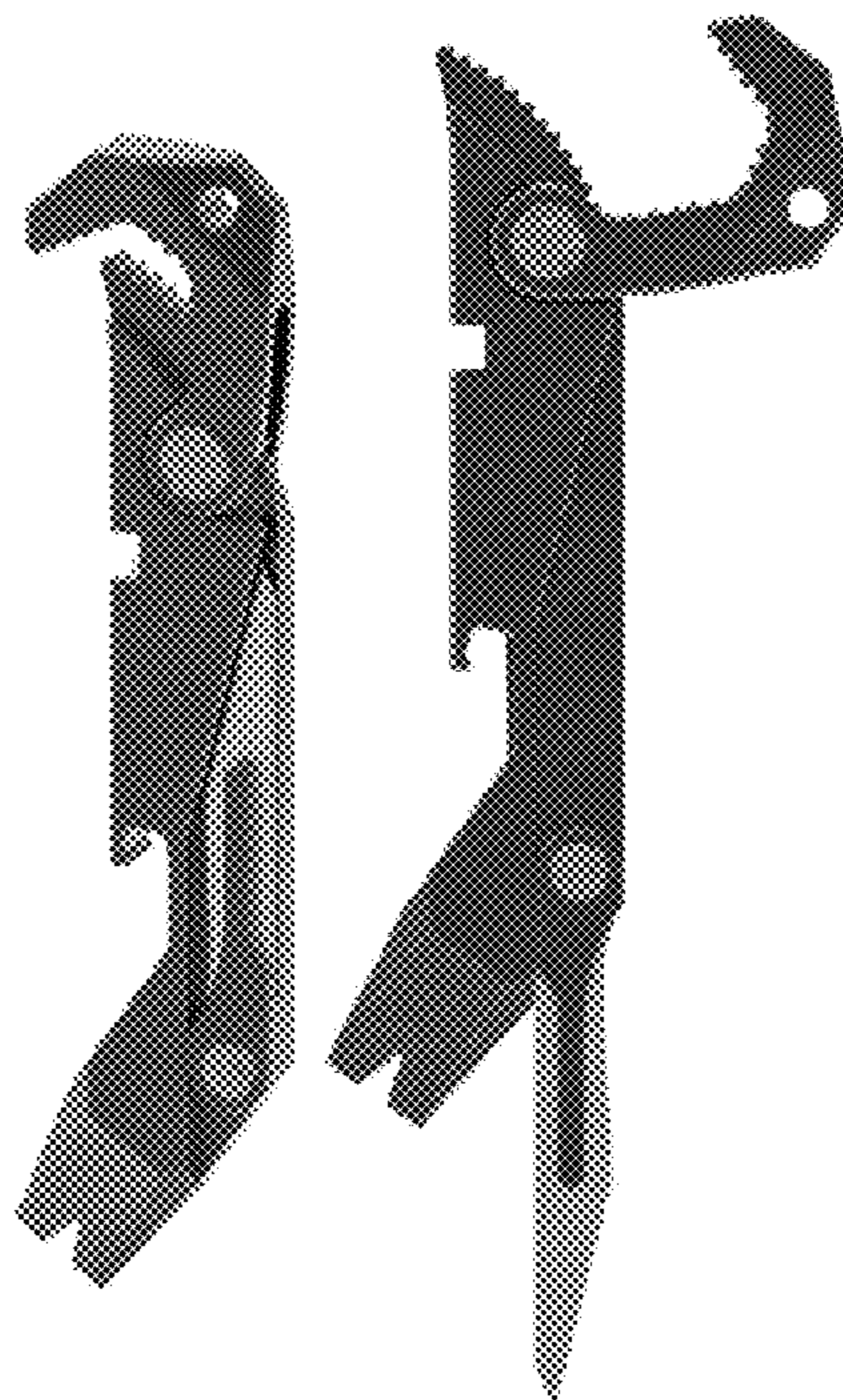

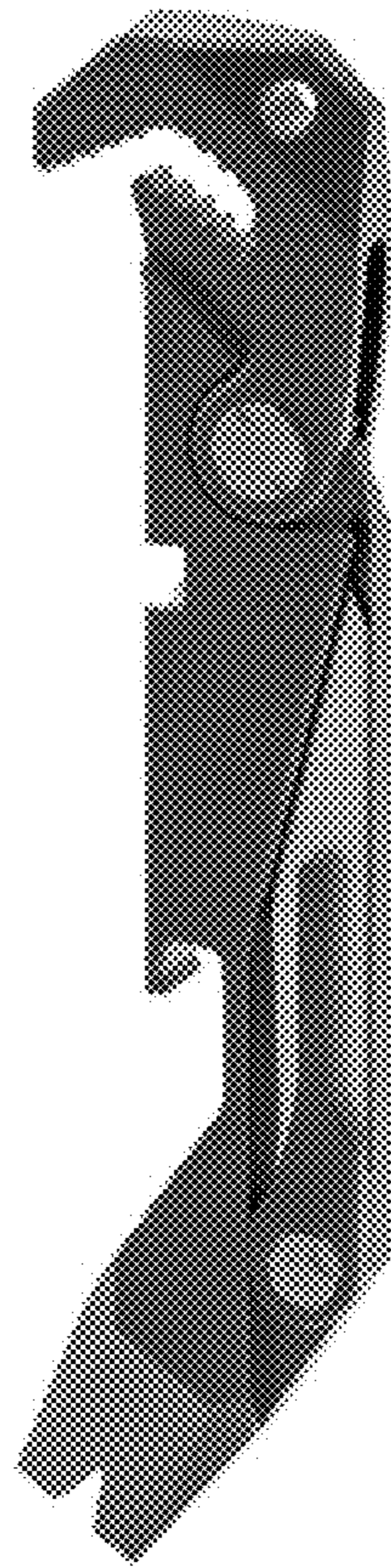

FIG. 1

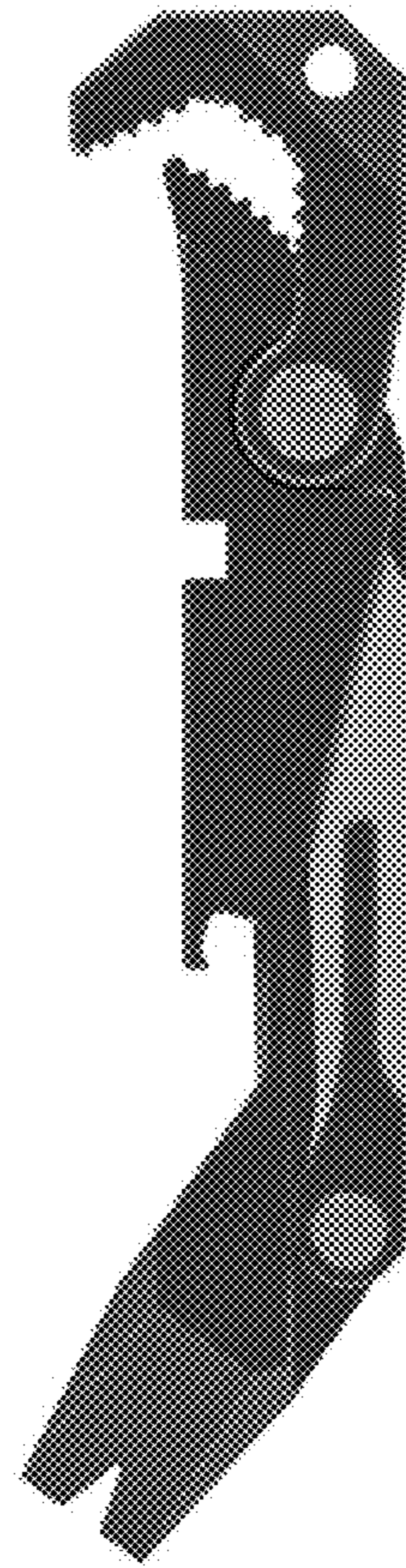

FIG. 2

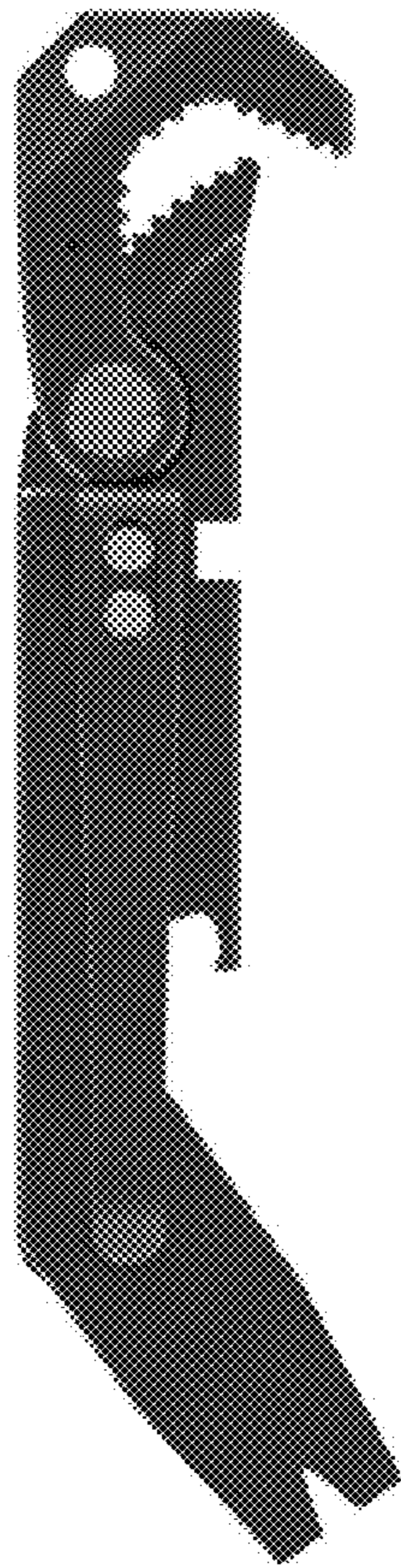

FIG. 3

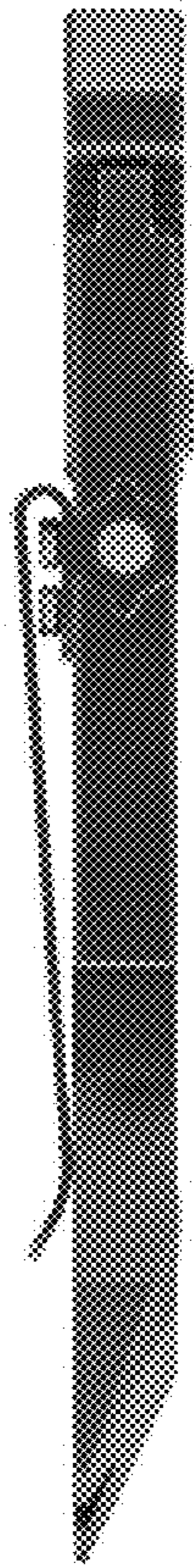

FIG. 4

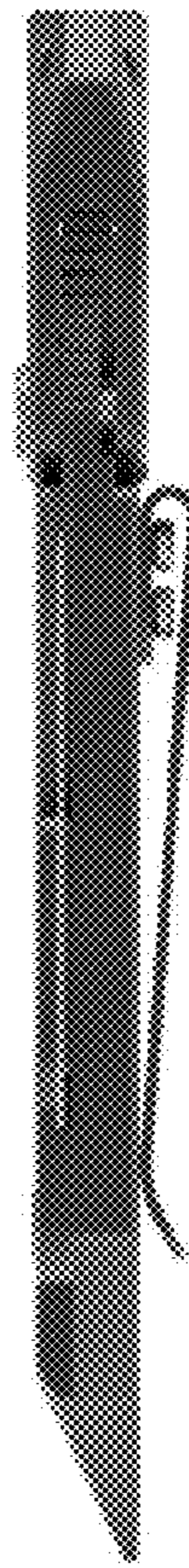

FIG. 5

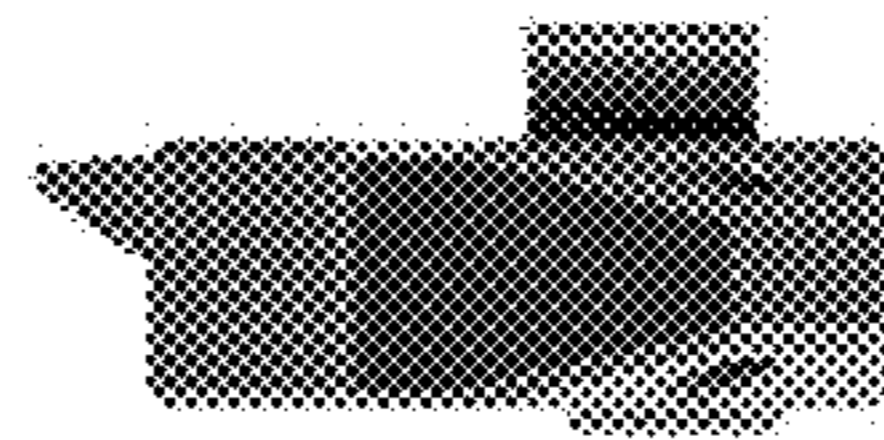

FIG. 6



FIG. 7

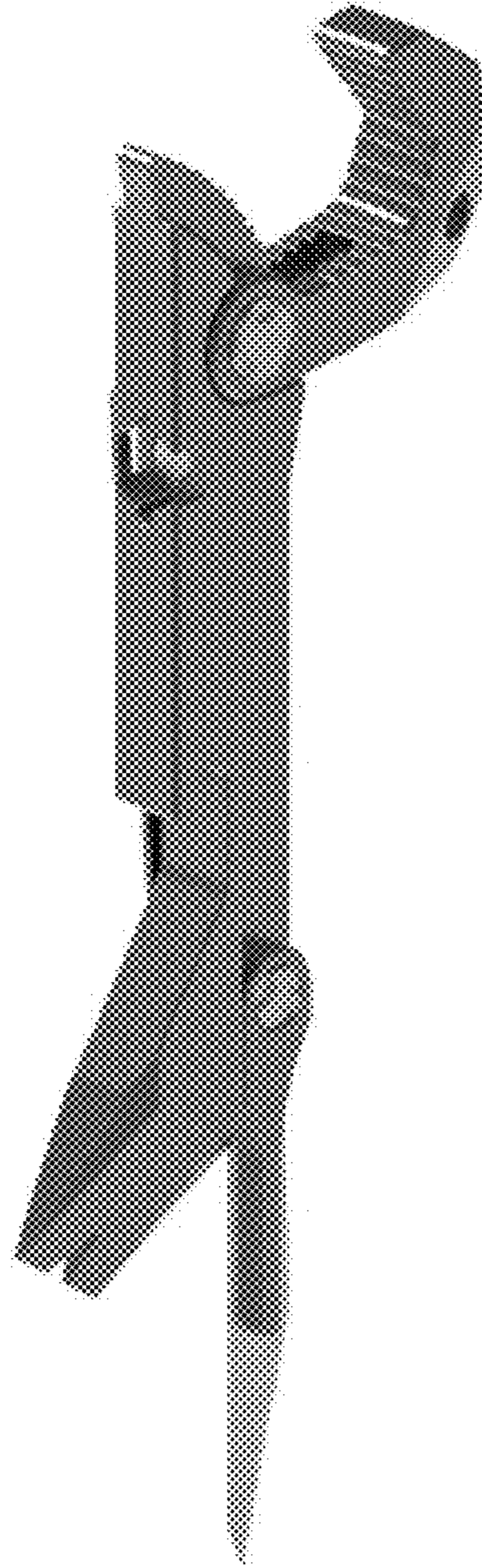

FIG. 8

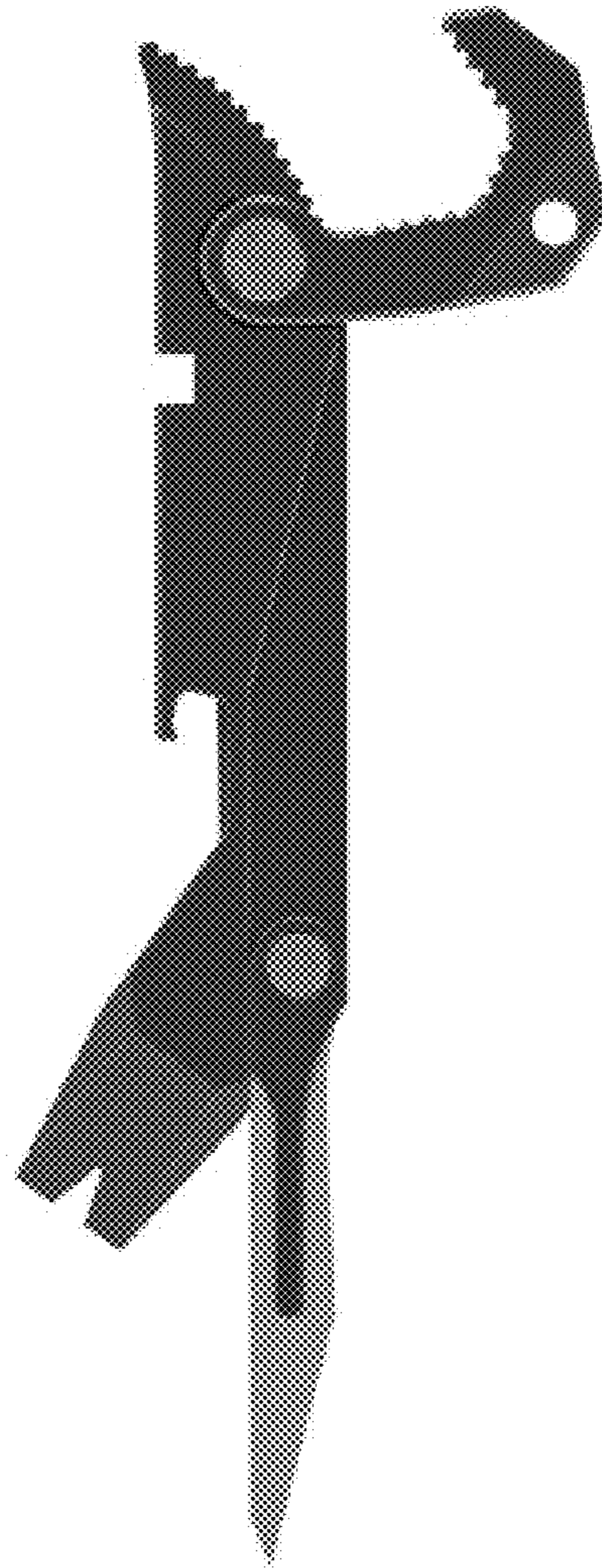

FIG. 9

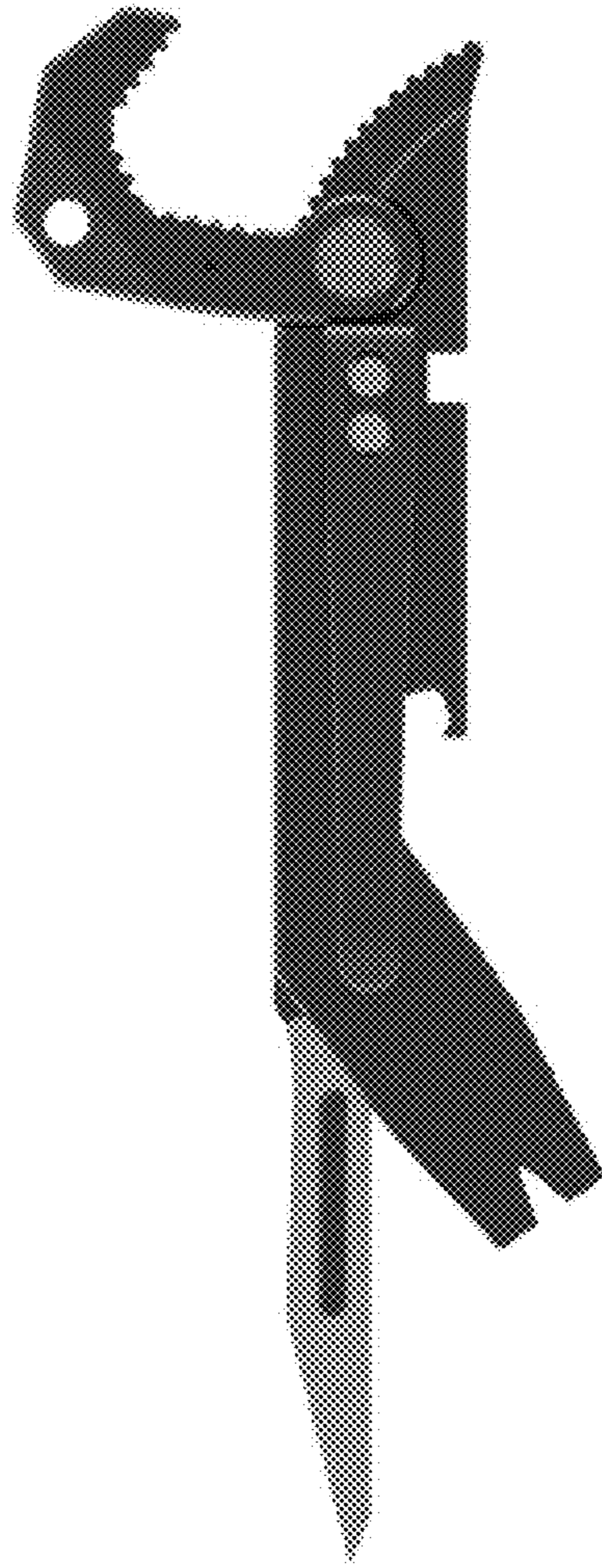

FIG. 10

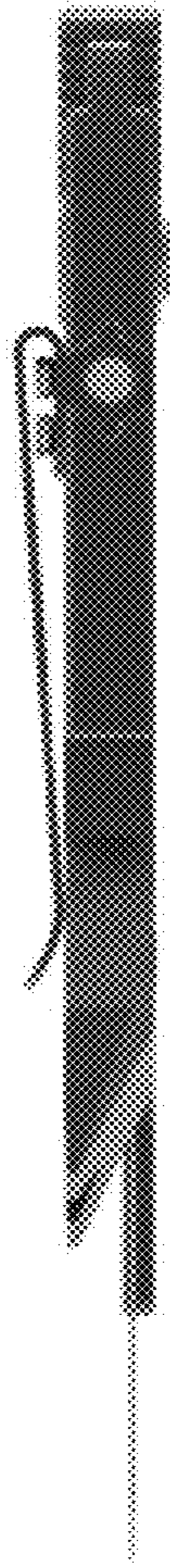

FIG. 11

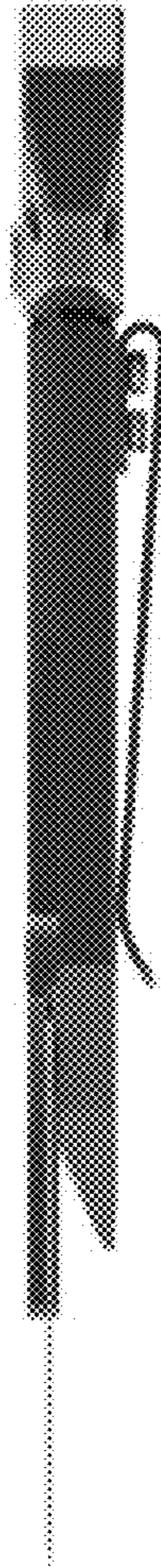

FIG. 12



FIG. 13



FIG. 14