



US00D980671S

(12) **United States Design Patent**
Schoenmakers et al.

(10) **Patent No.:** **US D980,671 S**
(45) **Date of Patent:** **** Mar. 14, 2023**

(54) **CONTAINER LID**

(71) Applicant: **The Decor Corporation Pty. Ltd.**,
Dandenong South (AU)

(72) Inventors: **Alexander Schoenmakers**, Dandenong
South (AU); **George Kotsiopoulos**,
Dandenong South (AU); **Toby Hartley**,
Dandenong South (AU)

(73) Assignee: **THE DECOR CORPORATION PTY. LTD.**,
Dandenong South (AU)

(**) Term: **15 Years**

(21) Appl. No.: **29/785,186**

(22) Filed: **May 24, 2021**

(30) **Foreign Application Priority Data**

Mar. 15, 2021 (AU) 202111461

(51) **LOC (14) Cl.** **07-99**

(52) **U.S. Cl.**
USPC **D7/392.1**

(58) **Field of Classification Search**
USPC D3/201, 203.1–203.3, 203.6–203.8, 318,
D3/326; D7/391, 392, 392.1, 703;
D9/414–418, 432, 434–436, 425, 440,
D9/443, 447, 455, 456, 499
CPC B65D 25/32; B65D 43/0218; B65D
43/0256; B65D 43/161; B65D
2543/00342; B65D 2543/00518; B65D
2543/00537; B65D 2543/00555; B65D
2543/00842; B65D 2543/0099

See application file for complete search history.

(56) **References Cited**

U.S. PATENT DOCUMENTS

D203,772 S 2/1966 Refers et al.
3,452,896 A 7/1969 Elliot

D284,254 S 6/1986 Carlson
4,700,842 A 10/1987 Grusin
D350,880 S 9/1994 Vanvalkenburg et al.
D425,833 S * 5/2000 Robinson D12/162
D642,054 S * 7/2011 Samartgis D9/435
D703,493 S 4/2014 De Ste. Croix et al.
D730,112 S * 5/2015 Yessin D7/392.1
D742,224 S * 11/2015 Thurin D7/629
D750,423 S * 3/2016 Shirley D7/391
D751,335 S * 3/2016 Shirley D7/391
D772,058 S * 11/2016 Urushidani D7/602

(Continued)

FOREIGN PATENT DOCUMENTS

GB 6140571 6/2021
NZ 4290090001 8/2021

OTHER PUBLICATIONS

Décor. Style & Organise Square, 710ml. No date specified, <https://www.decor.com.au/product/style-organise-square-710ml/> (Year: 0).*

(Continued)

Primary Examiner — Darcey E Gottschalk

(74) *Attorney, Agent, or Firm* — Cantor Colburn LLP

(57) **CLAIM**

The ornamental design for a container lid, as shown and described.

DESCRIPTION

FIG. 1 is top perspective view of a container lid showing my new design;
FIG. 2 is a side view thereof;
FIG. 3 is another side view thereof;
FIG. 4 is a front view thereof;
FIG. 5 is a rear view thereof;
FIG. 6 is a top view thereof;
FIG. 7 is a bottom view thereof; and,
FIG. 8 is a bottom perspective view thereof.

1 Claim, 6 Drawing Sheets

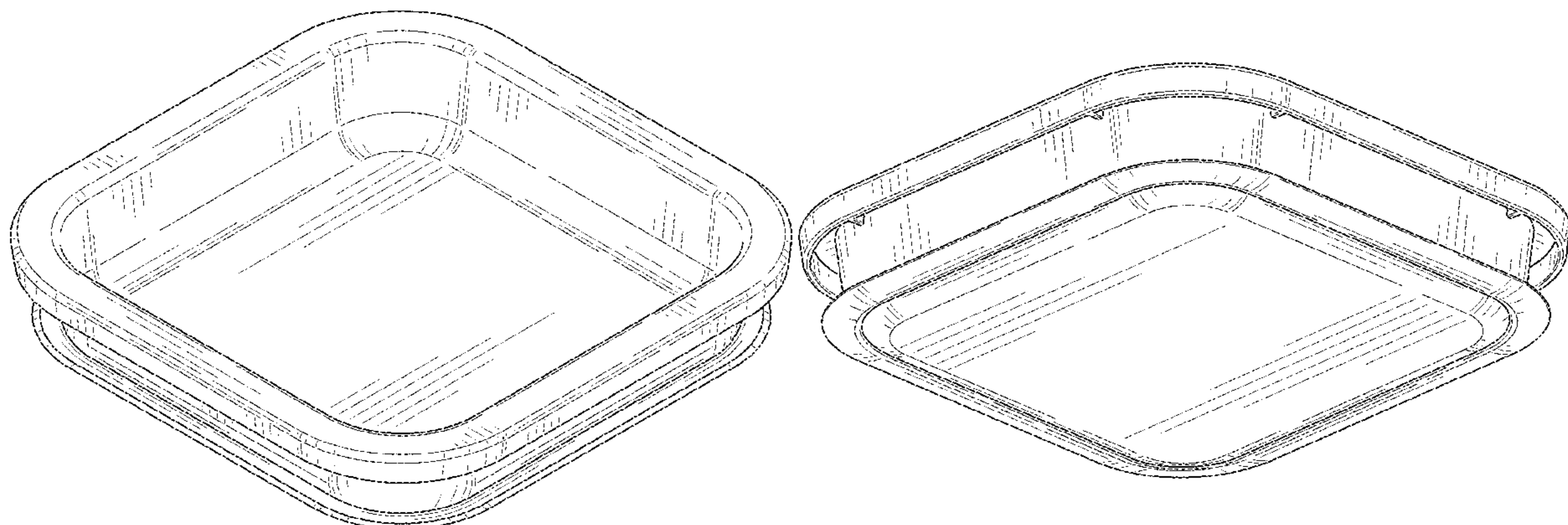

(56)

References Cited

U.S. PATENT DOCUMENTS

D792,210 S * 7/2017 Foster D9/425
D816,396 S 5/2018 Eades et al.

OTHER PUBLICATIONS

Amazon. Décor Pantry Style & Organise Food Storage Container | BPA Free, Clear/White, 780ml. Sep. 15, 2021. <https://www.amazon.com/D%C3%A9cor-Pantry-Organise-Storage-Container/dp/B09GBBTQD9?th=1> (Year: 2021).*

Decor Pantry Stack & Store, posted Sep. 15, 2021 [online], [retrieved on Oct. 12, 2022]. Retrieved on Internet, https://www.amazon.co.uk/D%C3%A9cor-Storage-Container-Dishwasher-Microwave/dp/B09GB8XJDM?ref=ast_sto_dp&th=1 (Year: 2021) pp. 1-9.

Notice of Allowance for U.S. Appl. No. 29/785,189, filed May 24, 2021; dated Nov. 7, 2022, pp. 1-31.

* cited by examiner

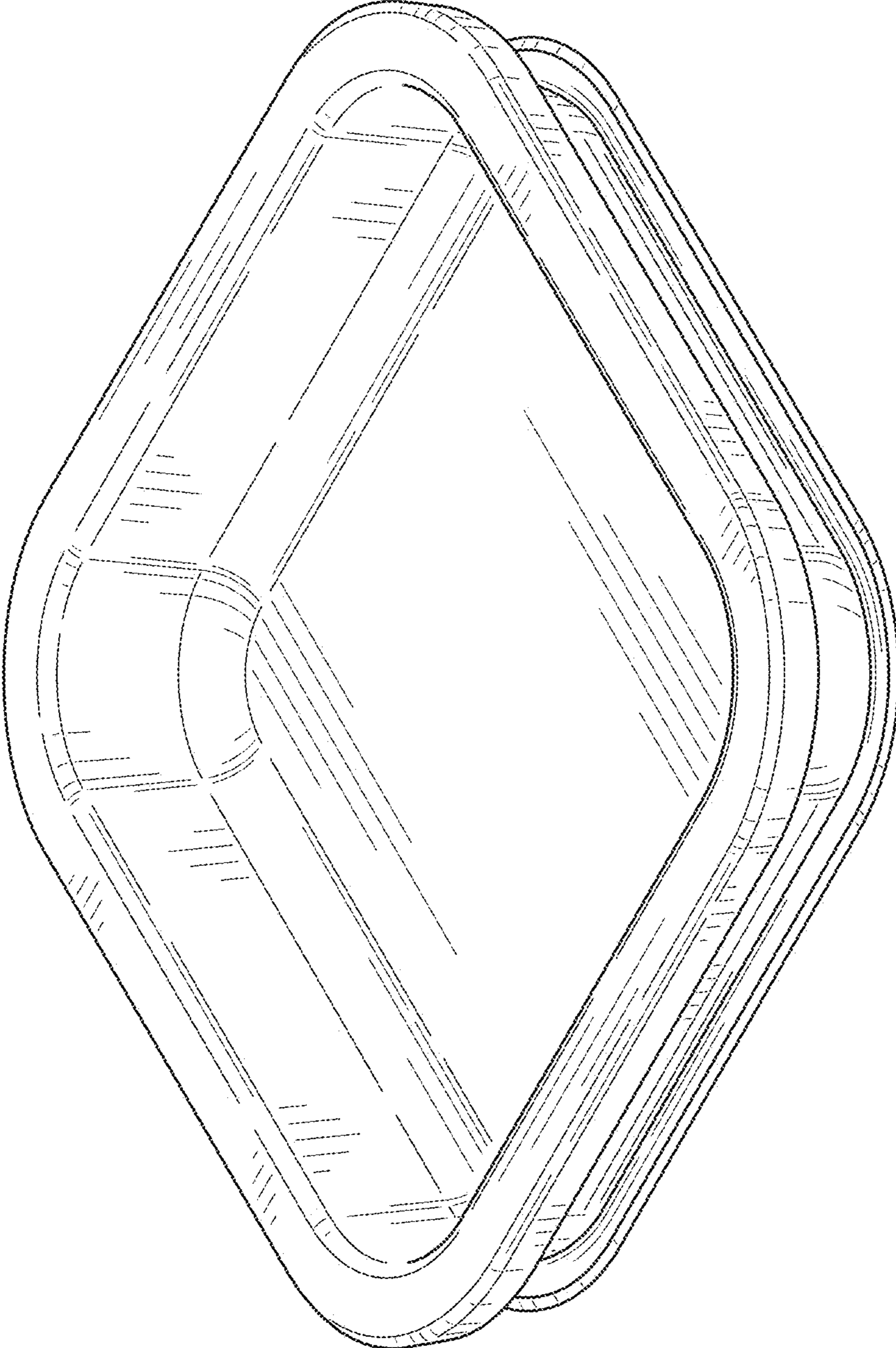

FIG. 1

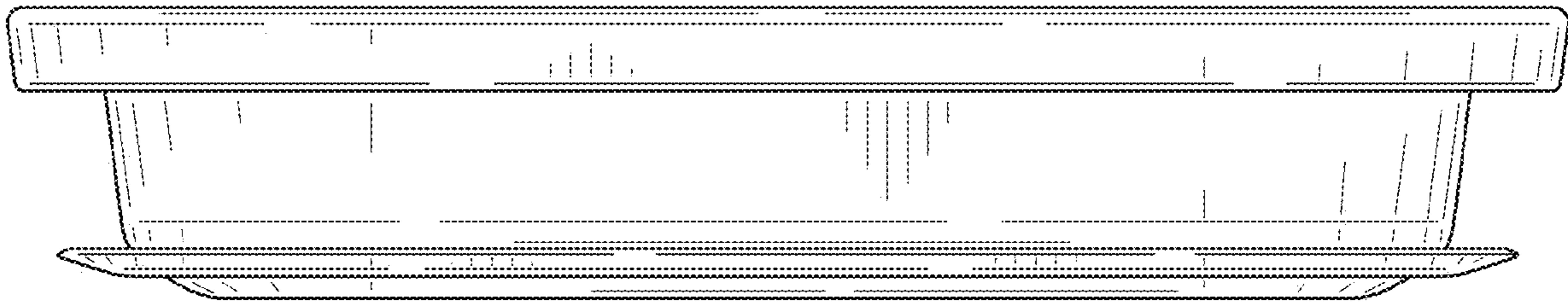

FIG. 2

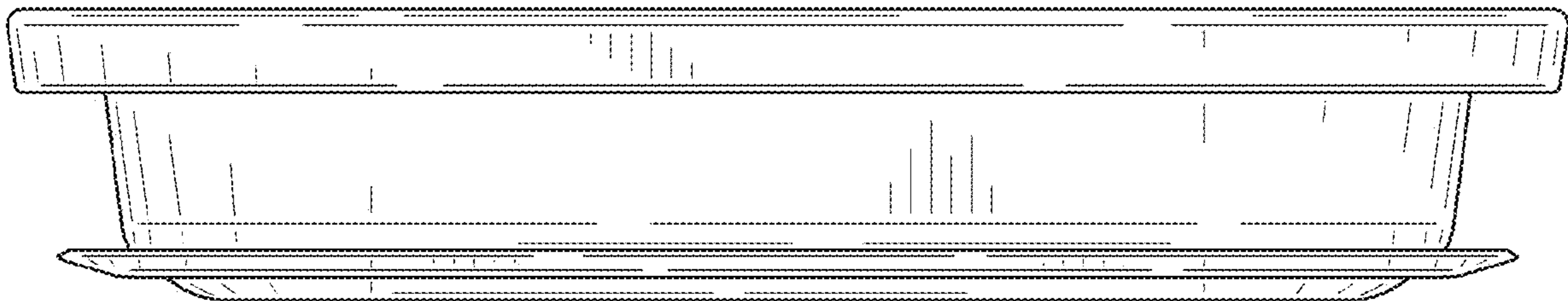

FIG. 3



FIG. 4

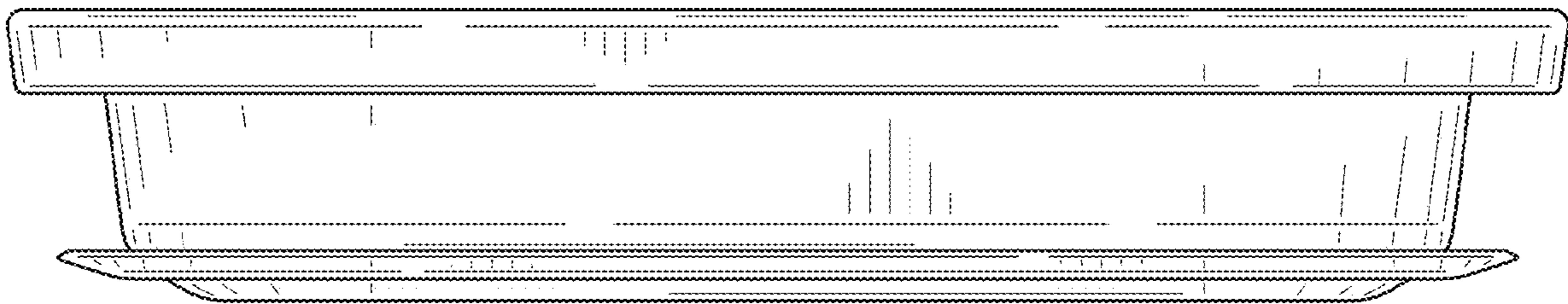

FIG. 5



FIG. 6

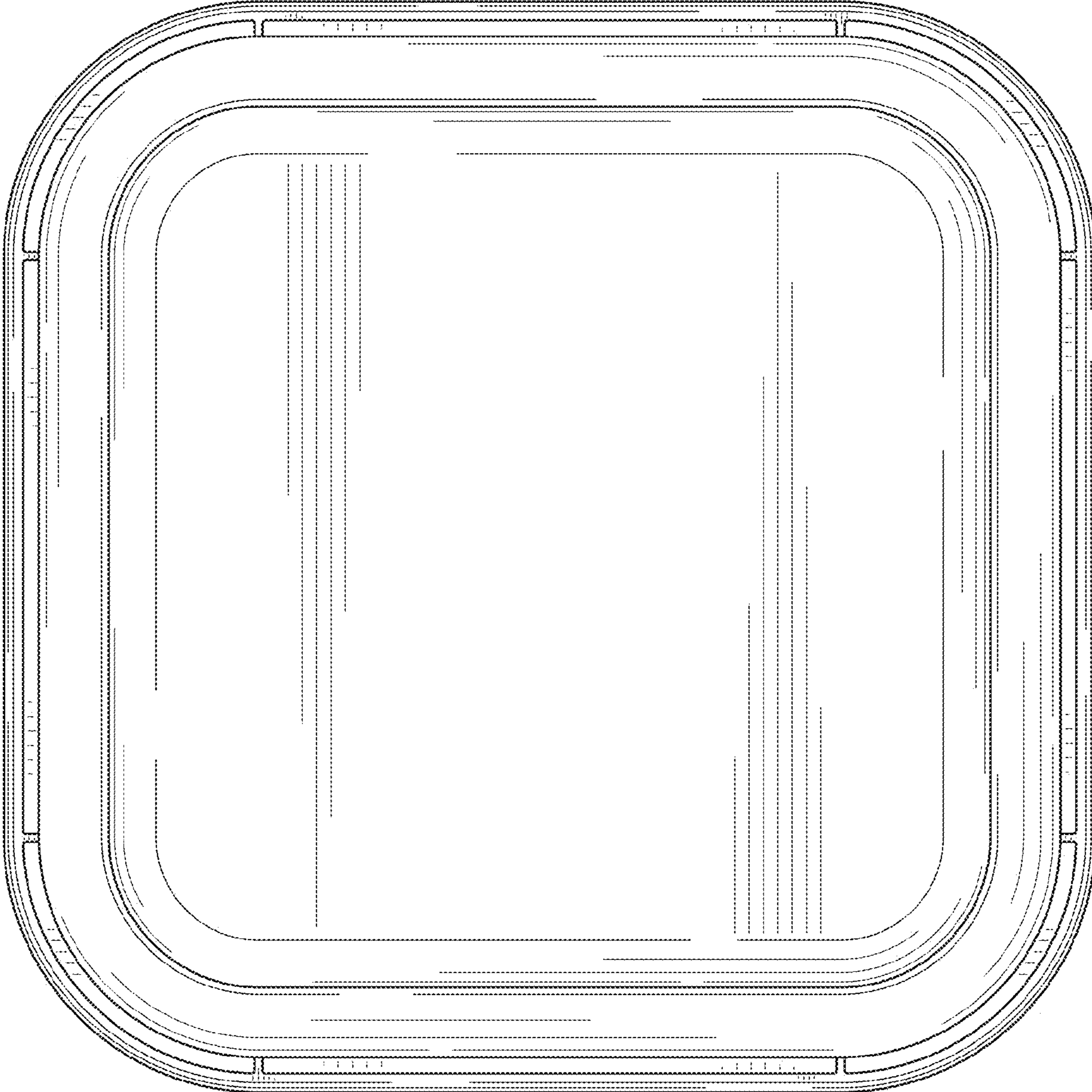

FIG. 7

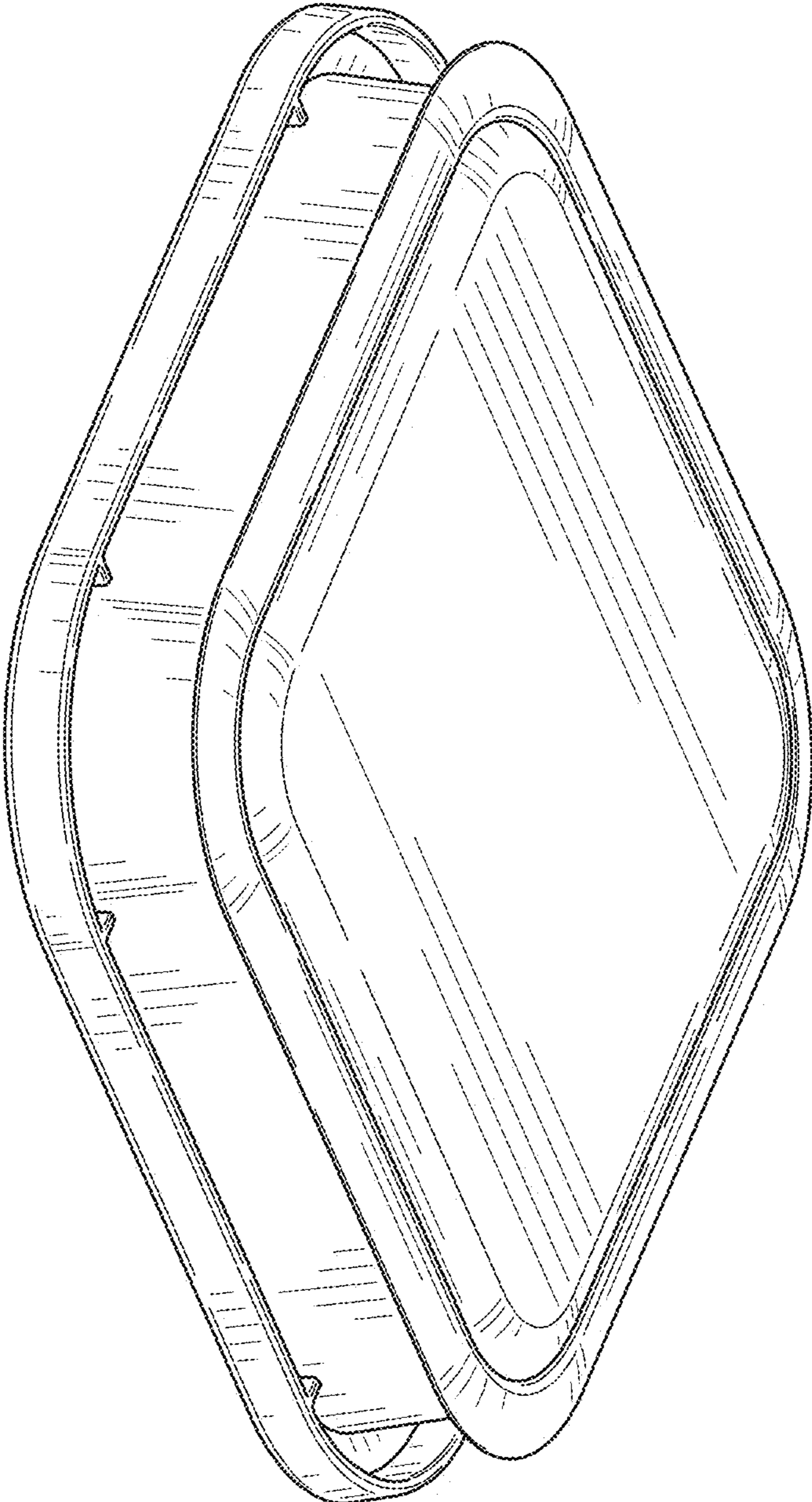

FIG. 8