



US00D980518S

(12) **United States Design Patent** (10) **Patent No.:** **US D980,518 S**  
**Tan et al.** (45) **Date of Patent:** **\*\* \*Mar. 7, 2023**

(54) **SINGLE-DOSE LAUNDRY DETERGENT UNIT**

(71) Applicant: **The Procter & Gamble Company**, Cincinnati, OH (US)

(72) Inventors: **Wee Hau Tan**, Singapore (SG); **Yaan Thomas Kinally**, Cambridge (GB); **Darren Seymour**, Cambridge (GB)

(73) Assignee: **The Procter & Gamble Company**, Cincinnati, OH (US)

(\* ) Notice: This patent is subject to a terminal disclaimer.

(\*\* ) Term: **15 Years**

(21) Appl. No.: **29/727,267**

(22) Filed: **Mar. 10, 2020**

(30) **Foreign Application Priority Data**

Sep. 10, 2019 (CN) ..... 201930497405.4

(51) **LOC (14) Cl.** ..... **28-02**

(52) **U.S. Cl.**  
USPC ..... **D28/8.1**

(58) **Field of Classification Search**  
USPC ..... D28/8.1, 8.2, 4-8, 9, 73, 76, 99;  
D9/702-714, 425, 430; D32/29.1  
CPC .. C11D 17/0047-0091; C11D 17/0017; C11D 17/0095

See application file for complete search history.

D353,940 S 1/1995 Ricciarelli  
5,437,407 A 8/1995 Kim  
D392,433 S 3/1998 Norris  
D396,904 S 8/1998 Leu  
D396,907 S 8/1998 Donnelly  
D415,601 S 10/1999 Sherman et al.  
D416,654 S 11/1999 Haynes  
D429,437 S 8/2000 Valenti  
D431,676 S 10/2000 Neergaard  
D437,972 S 2/2001 Harty  
D442,739 S 5/2001 Friesenhahn  
D443,108 S 5/2001 Friesenhahn  
D449,881 S 10/2001 Mock, Sr.  
D473,982 S 4/2003 Clark  
D478,657 S 8/2003 Fontana  
D509,935 S 9/2005 Burt  
D571,515 S 6/2008 Krause  
D577,294 S 9/2008 Suxdorf  
D578,893 S 10/2008 Rosinski et al.  
D581,805 S 12/2008 Suxdorf  
D585,287 S 1/2009 Rosinski et al.  
D588,766 S 3/2009 Dunshee  
D607,163 S 12/2009 Swiderski  
D610,002 S 2/2010 Frank  
D610,753 S 2/2010 Moskowitz  
D613,026 S 4/2010 Fitzpatrick et al.  
D617,843 S 6/2010 Heinke  
D621,275 S 8/2010 Marotti et al.  
D642,911 S 8/2011 Gonzalez  
D646,449 S 10/2011 Cheng  
D648,214 S 11/2011 Gonzalez  
D656,669 S 3/2012 Davis  
D657,910 S 4/2012 Davis  
D659,009 S 5/2012 Boyer et al.  
D671,329 S 11/2012 Van Straten  
D677,335 S 3/2013 Murphy et al.  
D681,270 S 4/2013 Davis  
D686,066 S 7/2013 Macaulay et al.  
D686,067 S 7/2013 Macaulay et al.  
D701,759 S 4/2014 Abel et al.  
D703,532 S 4/2014 Merchant  
D716,650 S 11/2014 Robinson  
D725,479 S 3/2015 Ajichi et al.  
D729,069 S 5/2015 Ajichi et al.  
D743,787 S 11/2015 Hood  
D745,393 S 12/2015 Robinson  
D748,241 S 1/2016 Goode  
D752,439 S 3/2016 Abel et al.  
D753,487 S 4/2016 Wells  
D768,480 S 10/2016 Hood et al.  
D768,947 S 10/2016 Mantelli  
D769,522 S 10/2016 Venet  
D771,899 S 11/2016 Wehling

(56) **References Cited**

U.S. PATENT DOCUMENTS

D267,122 S 11/1982 Scotton et al.  
D271,817 S 12/1983 Collin  
D295,683 S 5/1988 Kirk  
D299,275 S 1/1989 Ott  
D302,481 S 7/1989 Fawzi  
D328,010 S 7/1992 Daenen  
D334,420 S 3/1993 Copeland et al.

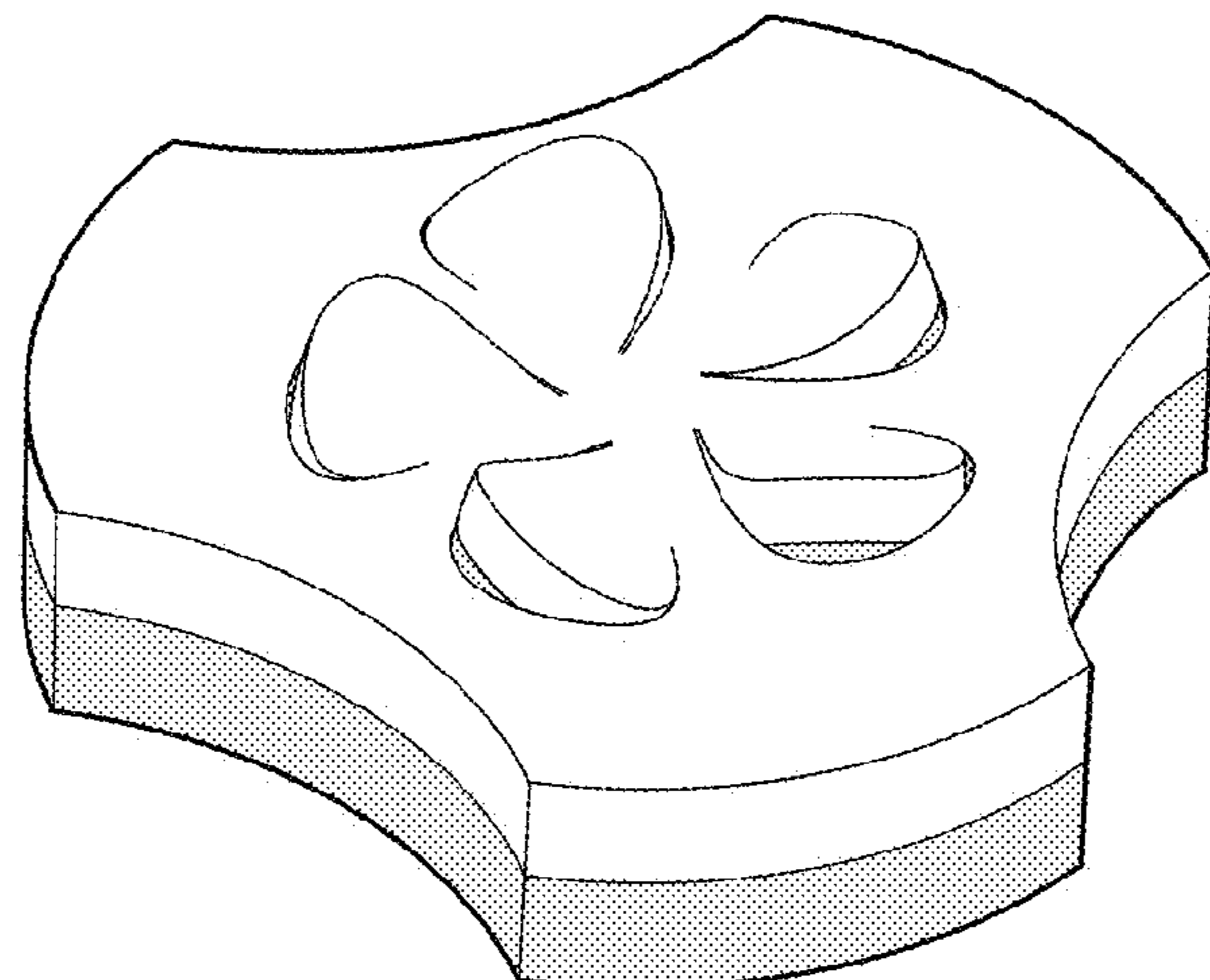

D783,799 S	4/2017	Goode	
D783,801 S	4/2017	Goode	
D798,658 S	10/2017	Masifilo	
D799,964 S	10/2017	Abel et al.	
D811,674 S	2/2018	Krause	
D816,414 S	5/2018	Thompson et al.	
D817,588 S	5/2018	Fraser	
D821,645 S	6/2018	Nelemans	
D822,298 S	7/2018	Krause	
D822,927 S	7/2018	Krause	
D827,428 S	9/2018	Torres	
D829,105 S	9/2018	Templeman	
D829,377 S	* 9/2018	Hartman .....	D6/601
D829,546 S	10/2018	Gagliardo et al.	
D831,496 S	10/2018	Silva	
10,089,904 B2	10/2018	Bowen et al.	
D832,715 S	11/2018	Zinovieff et al.	
D832,716 S	11/2018	Zinovieff et al.	
D833,698 S	11/2018	Lyne	
D833,868 S	11/2018	Marotti	
10,262,560 B2	4/2019	Craig et al.	
D848,060 S	* 5/2019	Ludert .....	D28/7
D850,277 S	6/2019	Murchison et al.	
D851,744 S	6/2019	Huang	
D858,301 S	9/2019	Lowery et al.	
D863,612 S	10/2019	Panagiotis et al.	
D863,957 S	10/2019	Riffe et al.	
D867,130 S	11/2019	Merchant et al.	
D867,717 S	* 11/2019	Chavez .....	D1/128
D868,953 S	12/2019	Mckendree	
D871,211 S	12/2019	Marcano et al.	
D871,919 S	1/2020	Lowery et al.	
D885,180 S	5/2020	Murchison	
D893,998 S	8/2020	Hinkle et al.	
D893,999 S	8/2020	Hinkle et al.	
D900,603 S	11/2020	Murchison et al.	
D902,710 S	11/2020	Hinkle et al.	
D902,711 S	11/2020	Rees	
D904,899 S	12/2020	Tan	
D905,917 S	12/2020	Kinally	
D906,804 S	1/2021	Rees	
D906,829 S	1/2021	Rees	
D907,486 S	1/2021	Hood et al.	
D910,455 S	2/2021	Lowery et al.	
D911,185 S	* 2/2021	Tan .....	D9/707
D913,584 S	* 3/2021	Tan .....	D1/120
D915,478 S	* 4/2021	De Geyter .....	D15/136
D940,390 S	1/2022	Tan et al.	
D944,450 S	* 2/2022	Ritter .....	D28/4
D954,559 S	6/2022	Tan et al.	
2006/0010634 A1	1/2006	Moser	
2017/0327997 A1	11/2017	Florence	

FOREIGN PATENT DOCUMENTS

JP	2000053998 A	2/2000
JP	1656034 S	3/2020
JP	1665522 S	8/2020
JP	D1665521 S	8/2020
JP	1668494 S	9/2020
JP	1668495 S	9/2020
WO	DM101063	5/2018
WO	DM101100	5/2018
WO	DM/102259	7/2018
WO	AD437_DM102959	9/2018
WO	AD449_DM201164	1/2019
WO	DM/202753	6/2019

OTHER PUBLICATIONS

U.S. Appl. No. 29/697,464, filed Jul. 9, 2019, Wee Hau Tan et al.  
 U.S. Appl. No. 29/717,567, filed Dec. 18, 2019, Suli Eunice Hong et al.  
 U.S. Appl. No. 29/717,570, filed Dec. 18, 2019, Suli Eunice Hong et al.  
 U.S. Appl. No. 29/757,068, filed Nov. 3, 2020, Wee Hau Tan et al.  
 U.S. Appl. No. 29/728,177, filed Mar. 17, 2020, Wee Hau Tan et al.

All Office Actions, U.S. Appl. No. 29/676,330.  
 All Office Actions, U.S. Appl. No. 29/683,553.  
 All Office Actions, U.S. Appl. No. 29/697,464.  
 Polymeric Foam, Urethane Scouring Pad, Graingers website 2020, <https://www.grainger.com/product/6NE88?gclid=CjOKCQjwhtT1BRCiARIsAGIY51K0thz...> site visited May 8, 2020.  
 All Office Actions, U.S. Appl. No. 29/717,567.  
 All Office Actions, U.S. Appl. No. 29/717,570.  
 All Office Actions; U.S. Appl. No. 29/728,177.  
 All Office Actions; U.S. Appl. No. 29/757,068.

\* cited by examiner

Primary Examiner — Rebecca Tsehaye

(57) CLAIM

The ornamental design for a single-dose laundry detergent unit, as shown and described.

DESCRIPTION

The patent or application file contains at least one drawing executed in color. Copies of this patent or patent application publication with color drawing(s) will be provided by the Office upon request and payment of the necessary fee.  
 FIG. 1 is a perspective view of a first embodiment of a single-dose laundry detergent unit, showing our new design;  
 FIG. 2 is a front view thereof;  
 FIG. 3 is a back view thereof;  
 FIG. 4 is a left view thereof;  
 FIG. 5 is a right view thereof;  
 FIG. 6 is a top view thereof;  
 FIG. 7 is a bottom view thereof;  
 FIG. 8 is a perspective view of a second embodiment of a single-dose laundry detergent unit, showing our new design;  
 FIG. 9 is a front view thereof;  
 FIG. 10 is a back view thereof;  
 FIG. 11 is a left view thereof;  
 FIG. 12 is a right view thereof;  
 FIG. 13 is a top view thereof;  
 FIG. 14 is a bottom view thereof;  
 FIG. 15 is a perspective view of a third embodiment of a single-dose laundry detergent unit, showing our new design;  
 FIG. 16 is a front view thereof;  
 FIG. 17 is a back view thereof;  
 FIG. 18 is a left view thereof;  
 FIG. 19 is a right view thereof;  
 FIG. 20 is a top view thereof;  
 FIG. 21 is a bottom view thereof;  
 FIG. 22 is a perspective view of a fourth embodiment of a single-dose laundry detergent unit, showing our new design;  
 FIG. 23 is a front view thereof;  
 FIG. 24 is a back view thereof;  
 FIG. 25 is a left view thereof;  
 FIG. 26 is a right view thereof;  
 FIG. 27 is a top view thereof;  
 FIG. 28 is a bottom view thereof;  
 FIG. 29 is a perspective view of a fifth embodiment of a single-dose laundry detergent unit, showing our new design;  
 FIG. 30 is a front view thereof;  
 FIG. 31 is a back view thereof;  
 FIG. 32 is a left view thereof;  
 FIG. 33 is a right view thereof;  
 FIG. 34 is a top view thereof;  
 FIG. 35 is a bottom view thereof;

FIG. 36 is a perspective view of a sixth embodiment of a single-dose laundry detergent unit, showing our new design;  
FIG. 37 is a front view thereof;  
FIG. 38 is a back view thereof;  
FIG. 39 is a left view thereof;  
FIG. 40 is a right view thereof;  
FIG. 41 is a top view thereof;  
FIG. 42 is a bottom view thereof;  
FIG. 43 is a perspective view of a seventh embodiment of a single-dose laundry detergent unit, showing our new design;  
FIG. 44 is a front view thereof;  
FIG. 45 is a back view thereof;  
FIG. 46 is a left view thereof;  
FIG. 47 is a right view thereof;  
FIG. 48 is a top view thereof;  
FIG. 49 is a bottom view thereof;  
FIG. 50 is a perspective view of an eighth embodiment of a single-dose laundry detergent unit, showing our new design;  
FIG. 51 is a front view thereof;  
FIG. 52 is a back view thereof;  
FIG. 53 is a left view thereof;

FIG. 54 is a right view thereof;  
FIG. 55 is a top view thereof;  
FIG. 56 is a bottom view thereof;  
FIG. 57 is a perspective view of a ninth embodiment of a single-dose laundry detergent unit, showing our new design;  
FIG. 58 is a front view thereof;  
FIG. 59 is a back view thereof;  
FIG. 60 is a left view thereof;  
FIG. 61 is a right view thereof;  
FIG. 62 is a top view thereof and;  
FIG. 63 is a bottom view thereof;  
FIG. 64 is a perspective view of a tenth embodiment of a single-dose laundry detergent unit, showing our new design;  
FIG. 65 is a front view thereof;  
FIG. 66 is a back view thereof;  
FIG. 67 is a left view thereof;  
FIG. 68 is a right view thereof;  
FIG. 69 is a top view thereof; and,  
FIG. 70 is a bottom view thereof.

**1 Claim, 70 Drawing Sheets  
(63 of 70 Drawing Sheet(s) Filed in Color)**

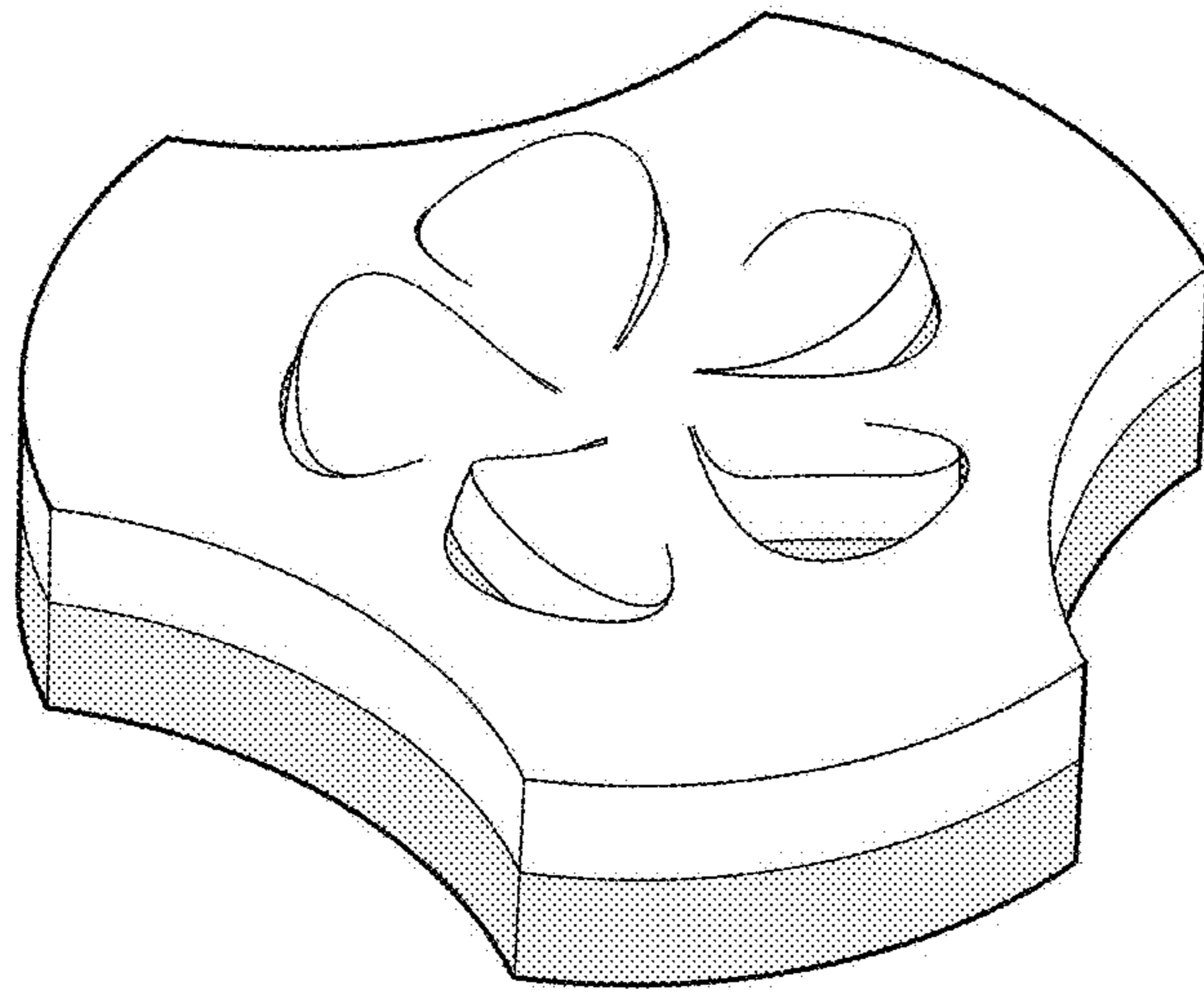

Fig. 1

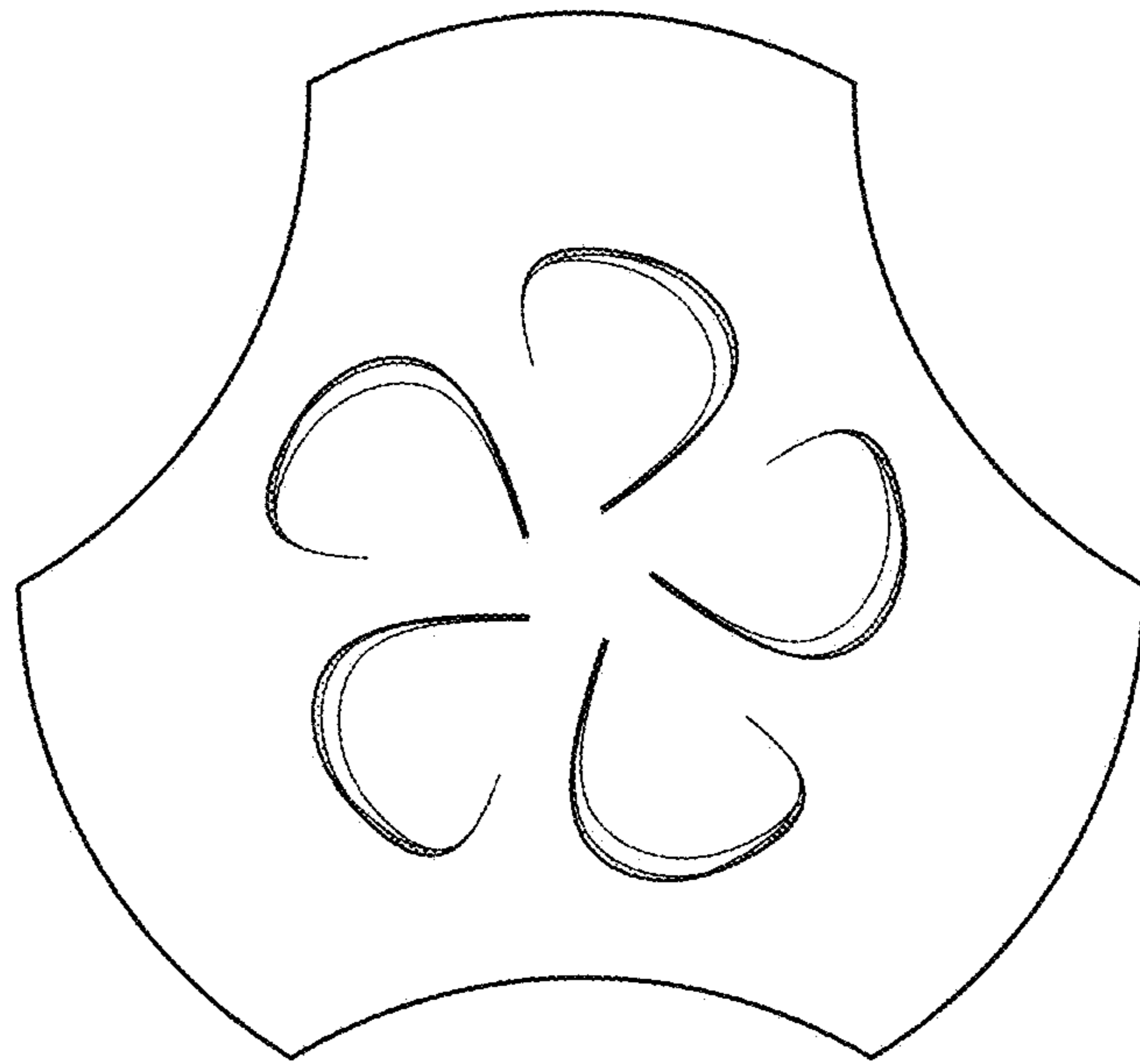

Fig. 2

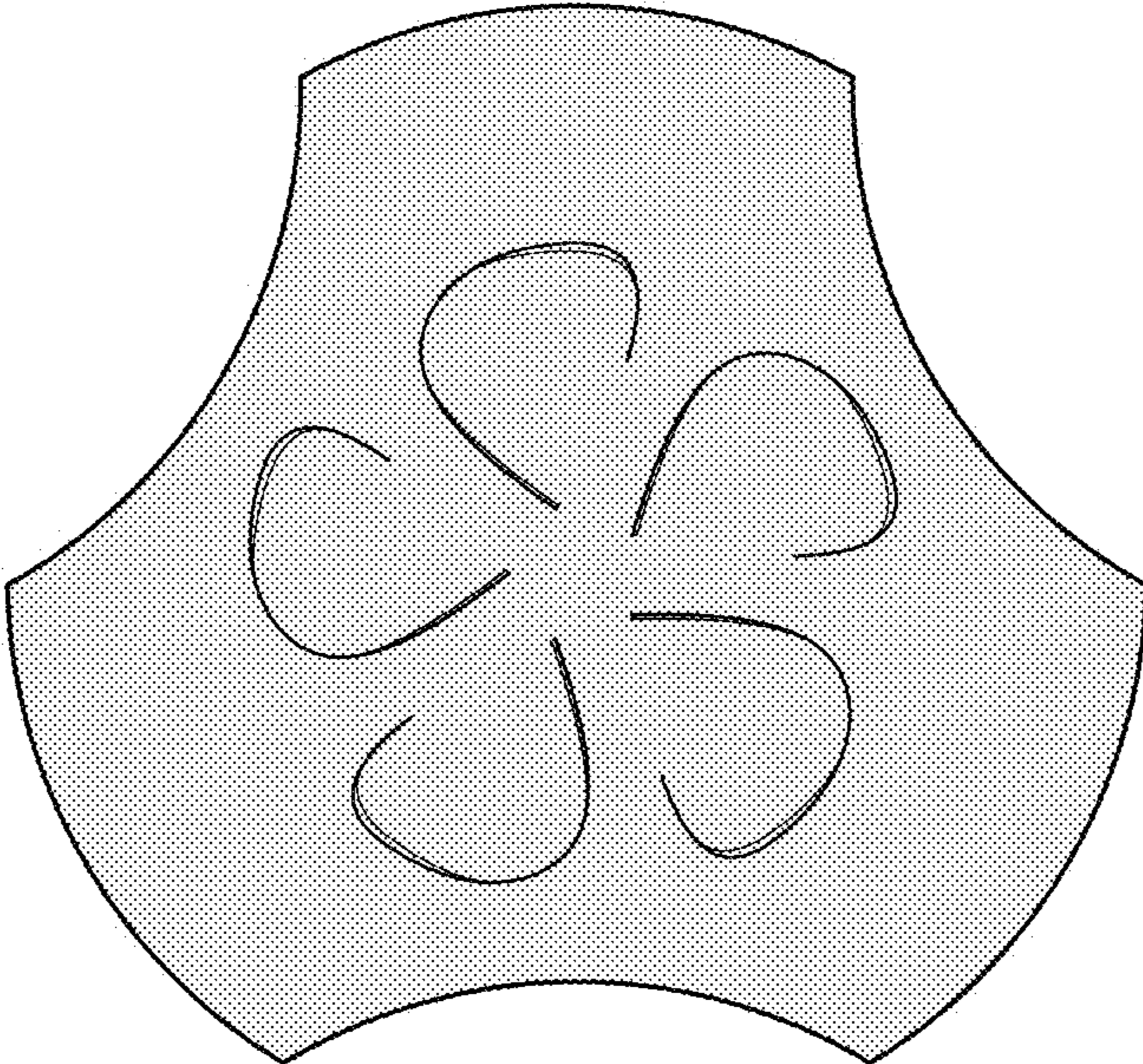

Fig. 3

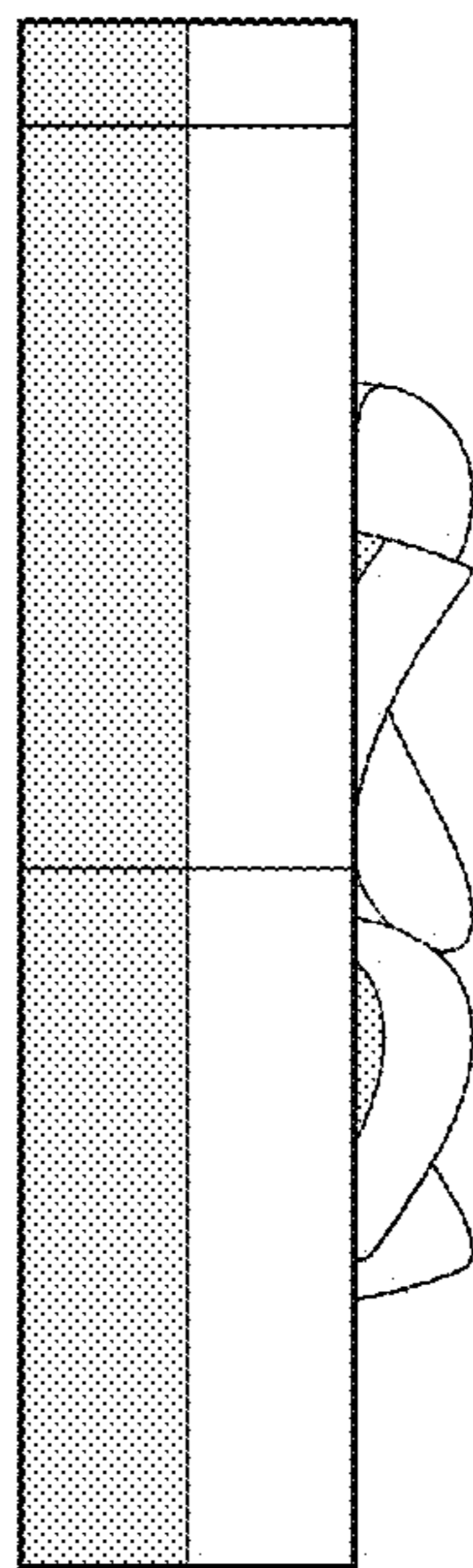

Fig. 4

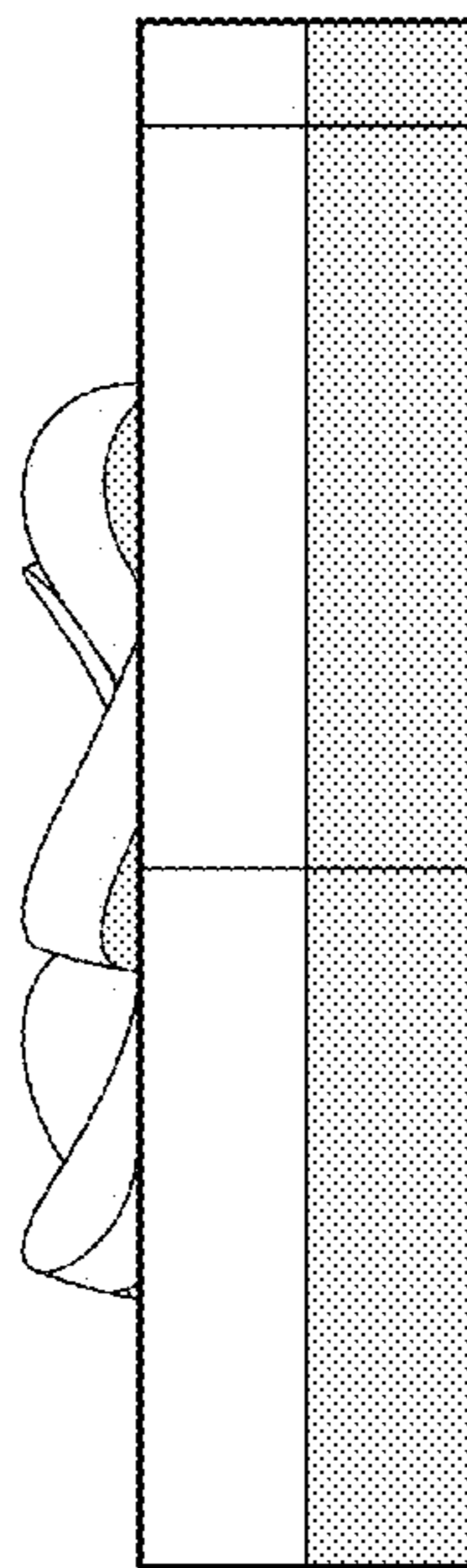

Fig. 5



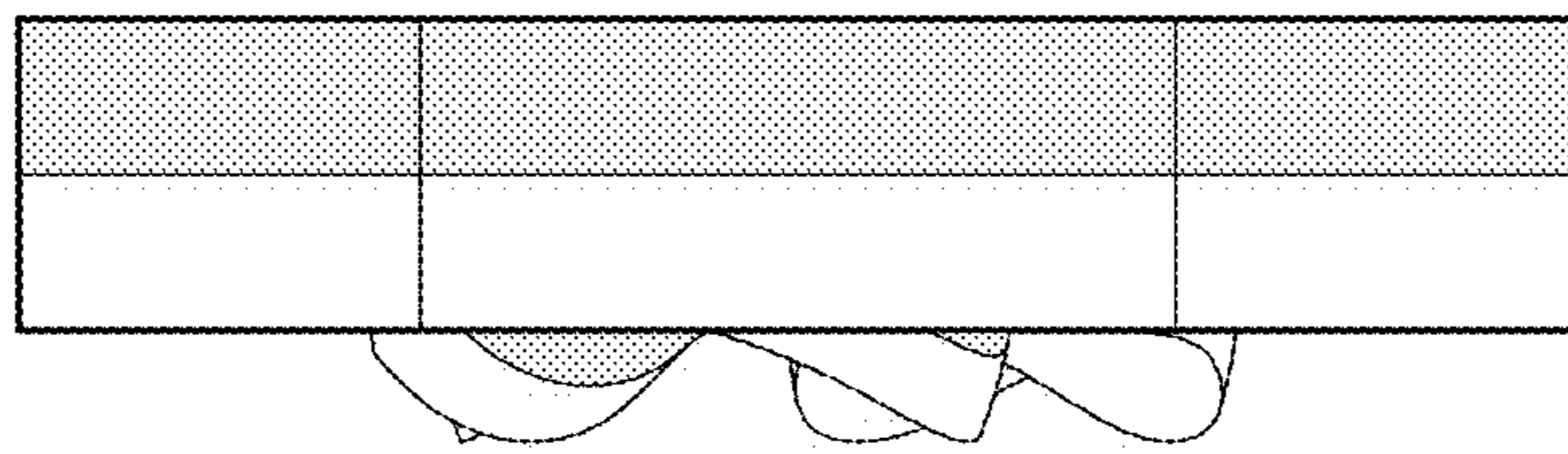

Fig. 6

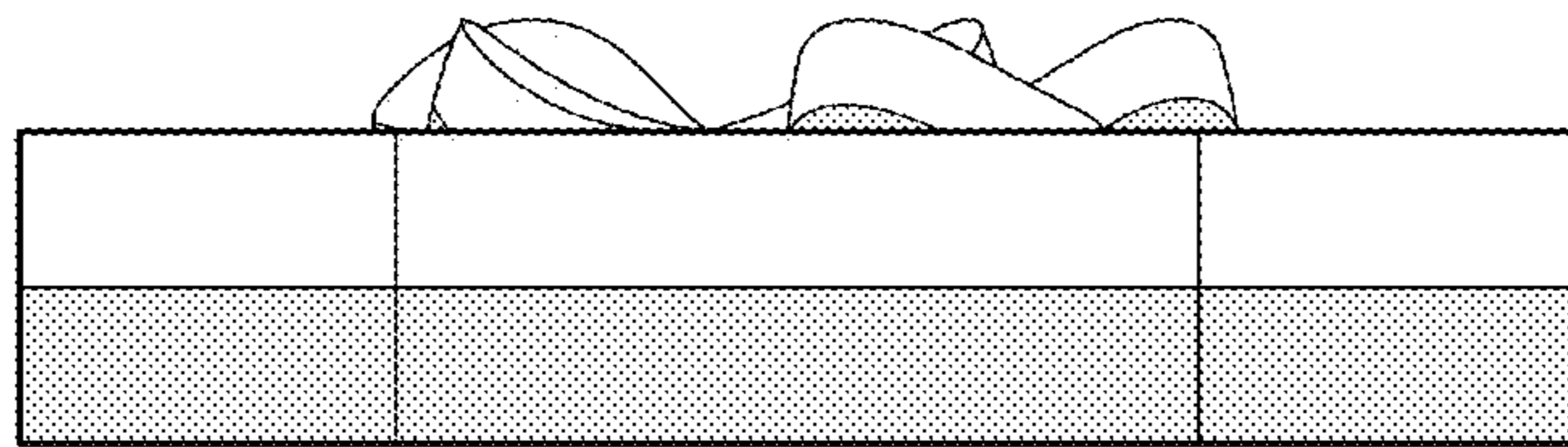

Fig. 7

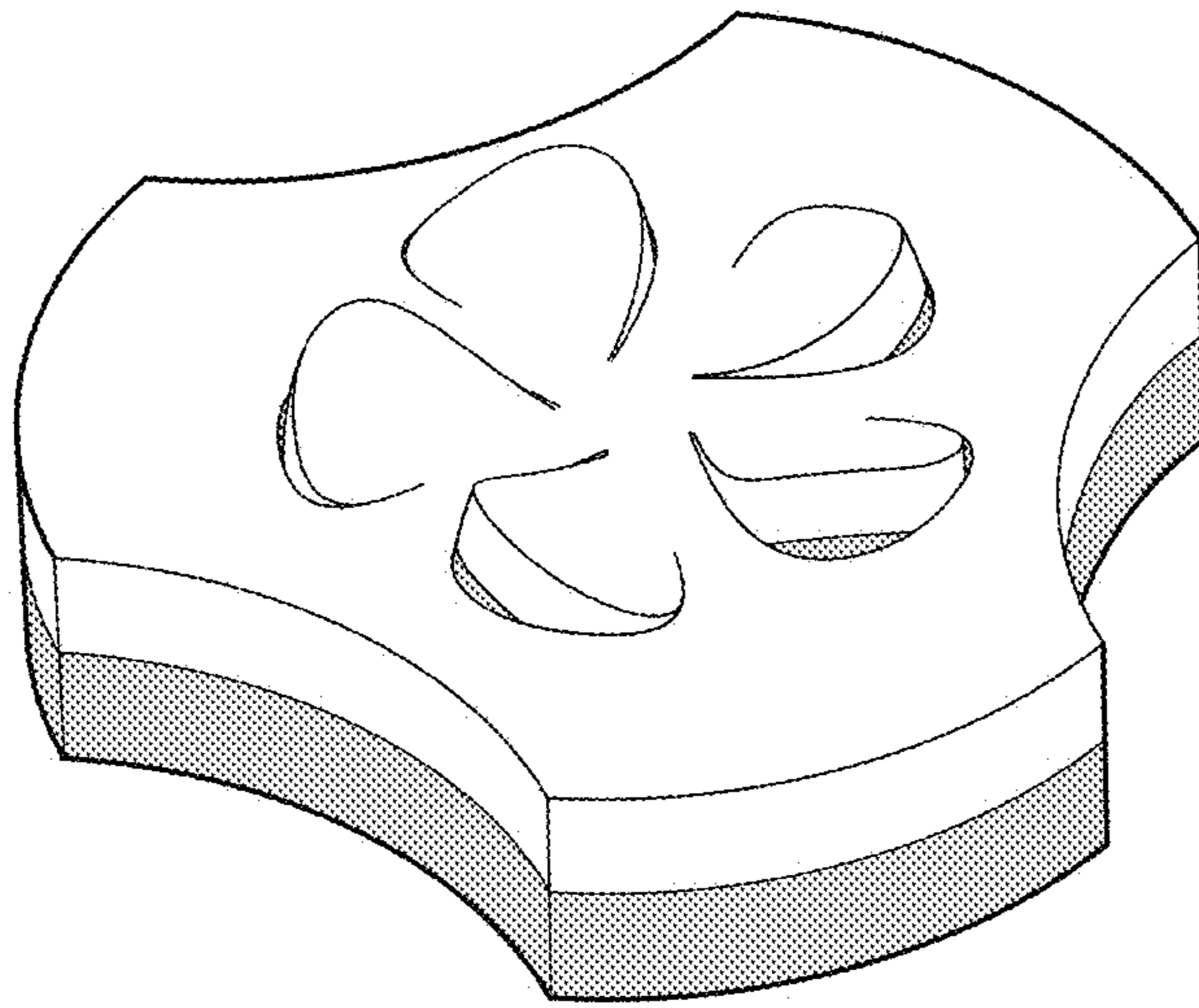

Fig. 8

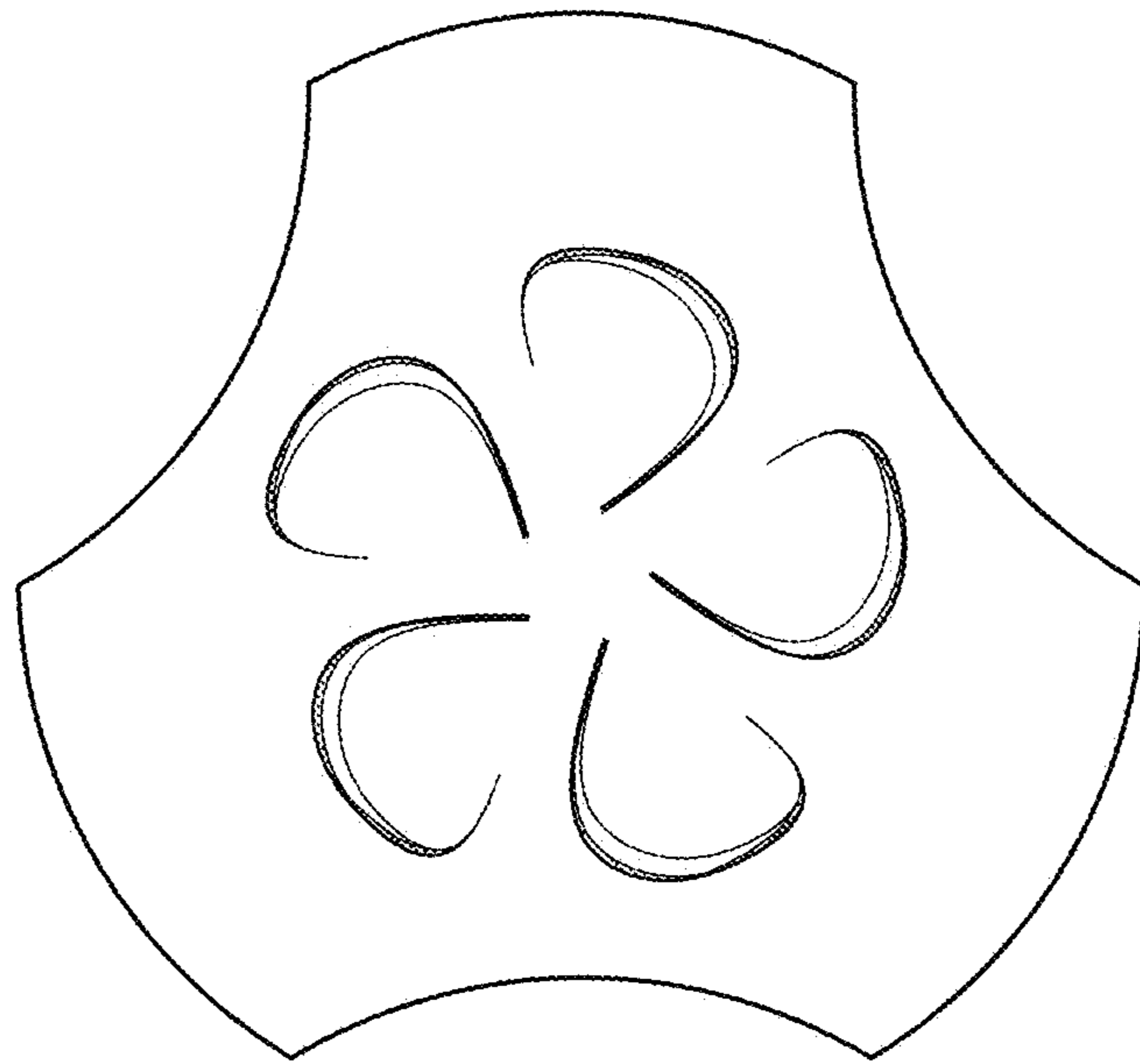

Fig. 9

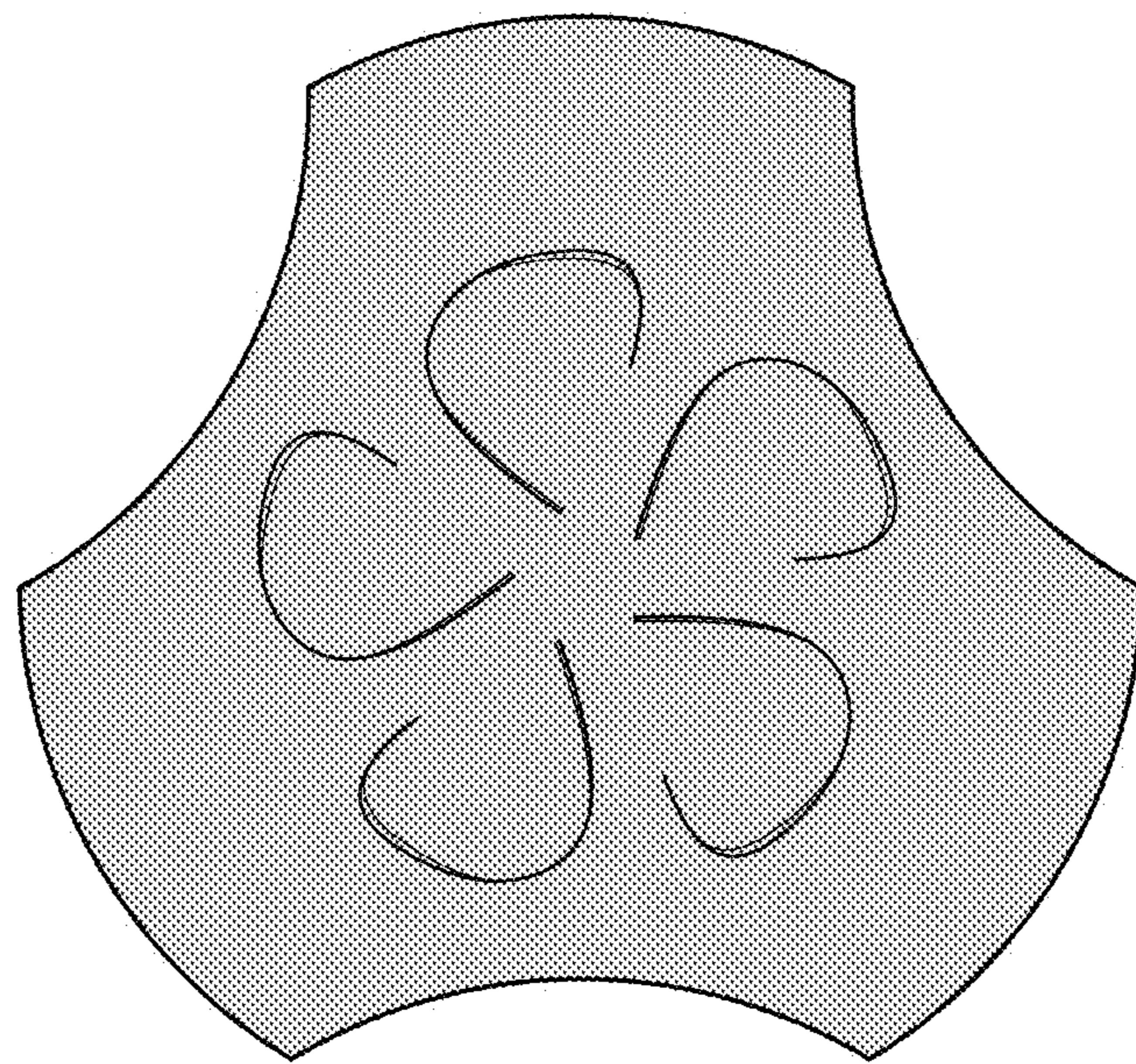

Fig. 10

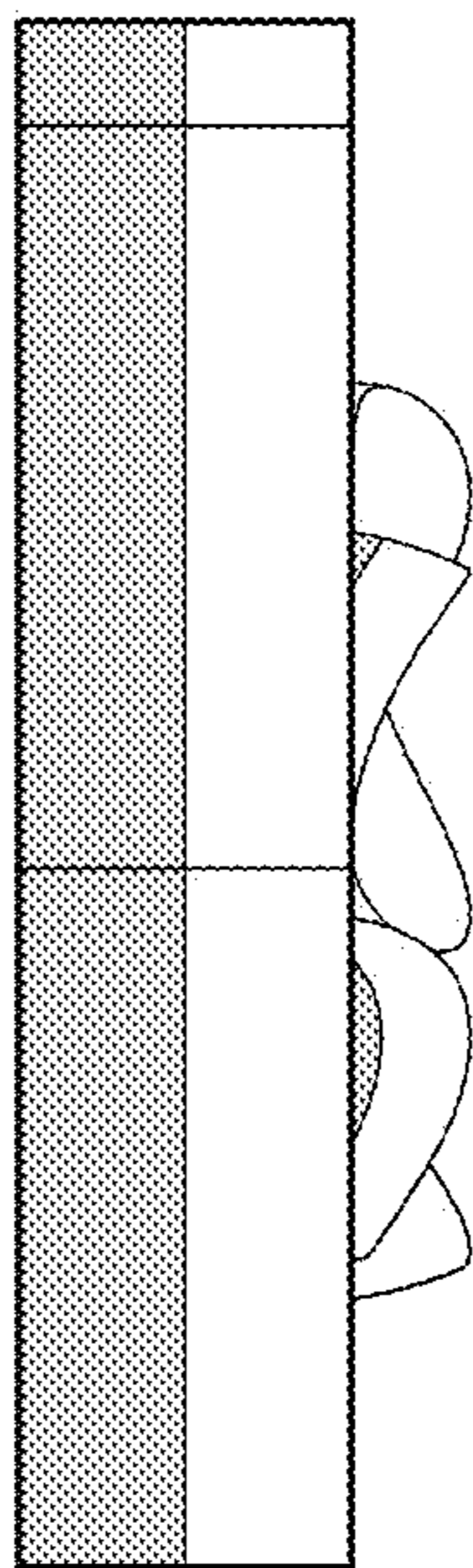

Fig. 11

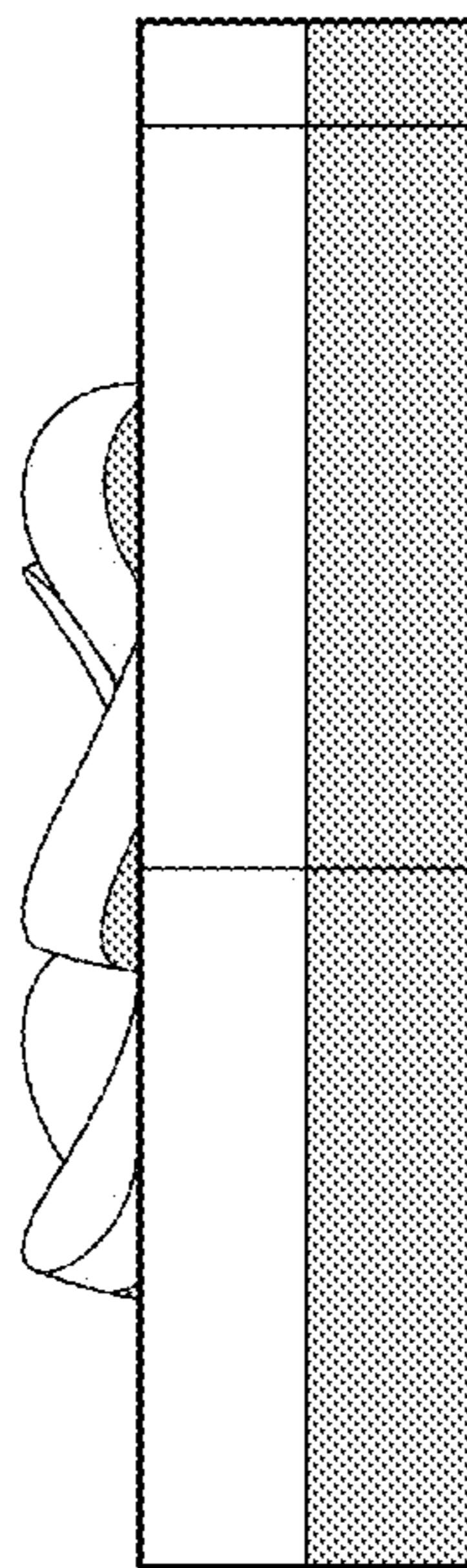

Fig. 12

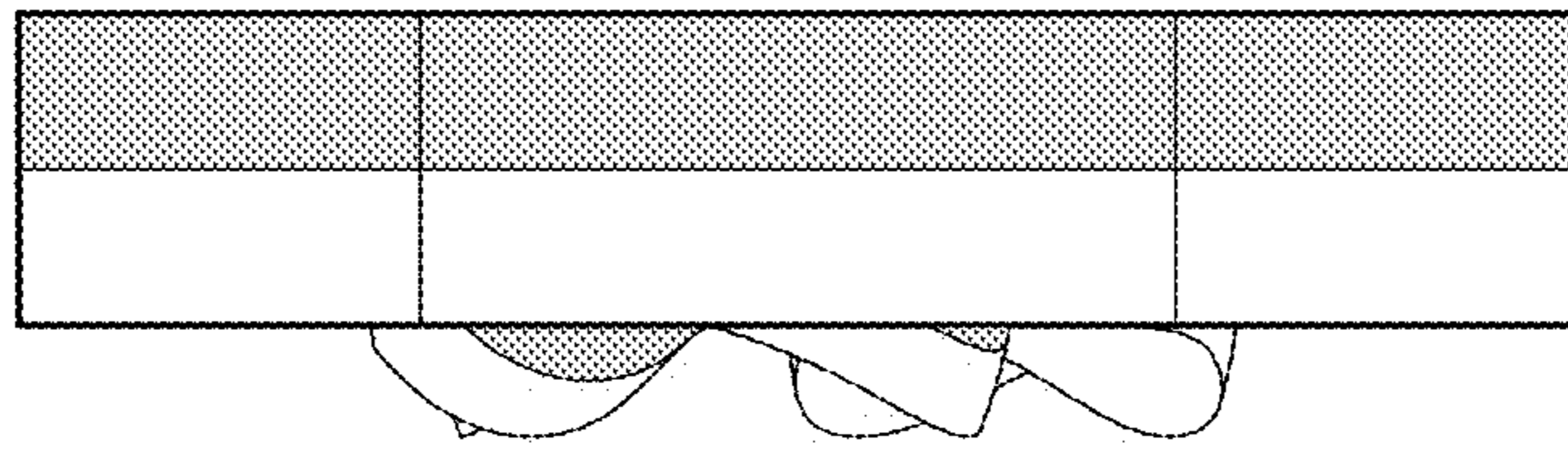

Fig. 13



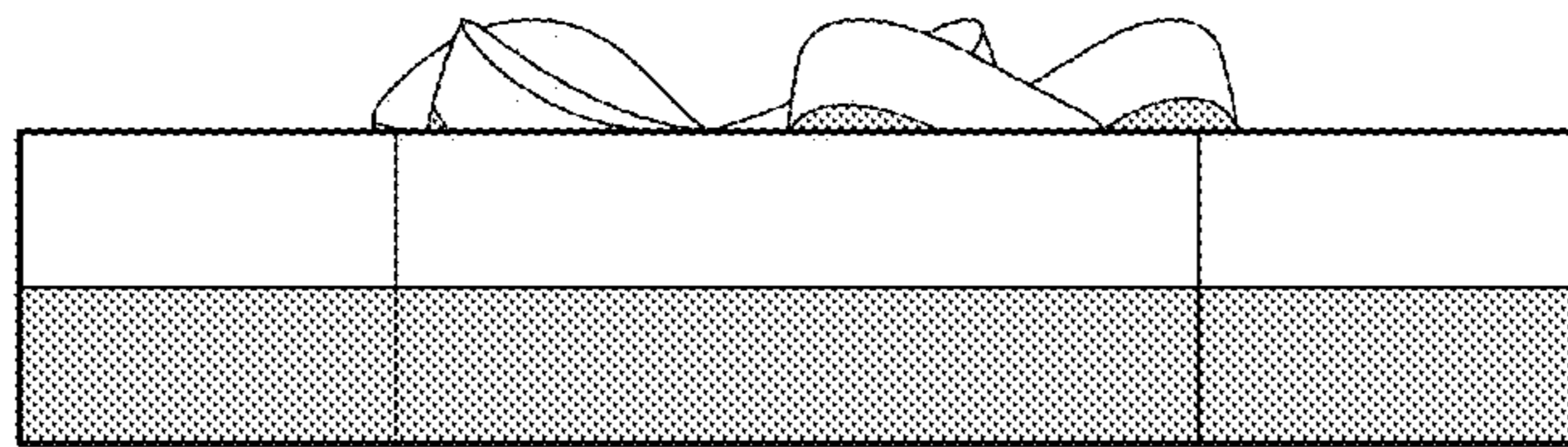

Fig. 14

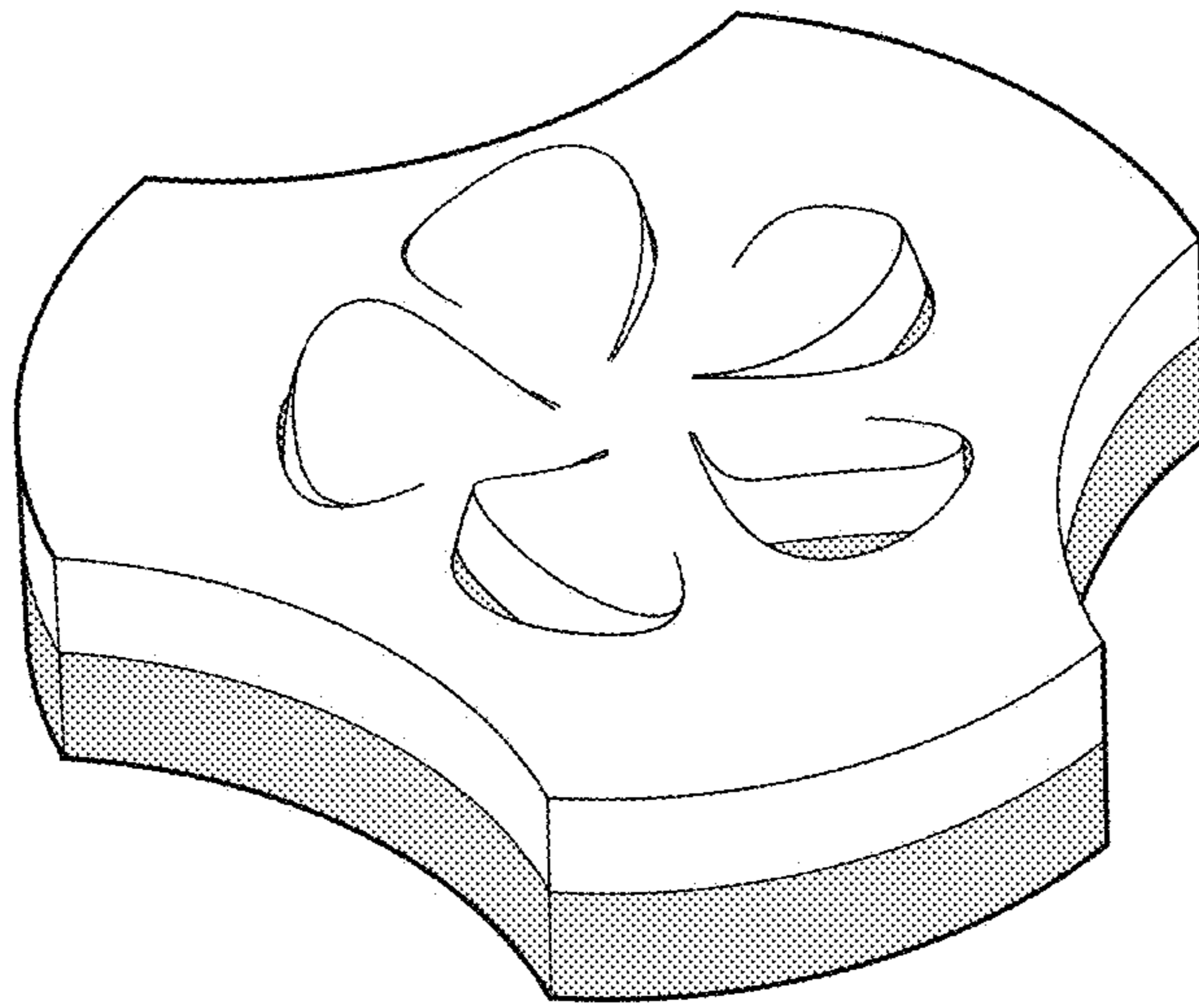

Fig. 15

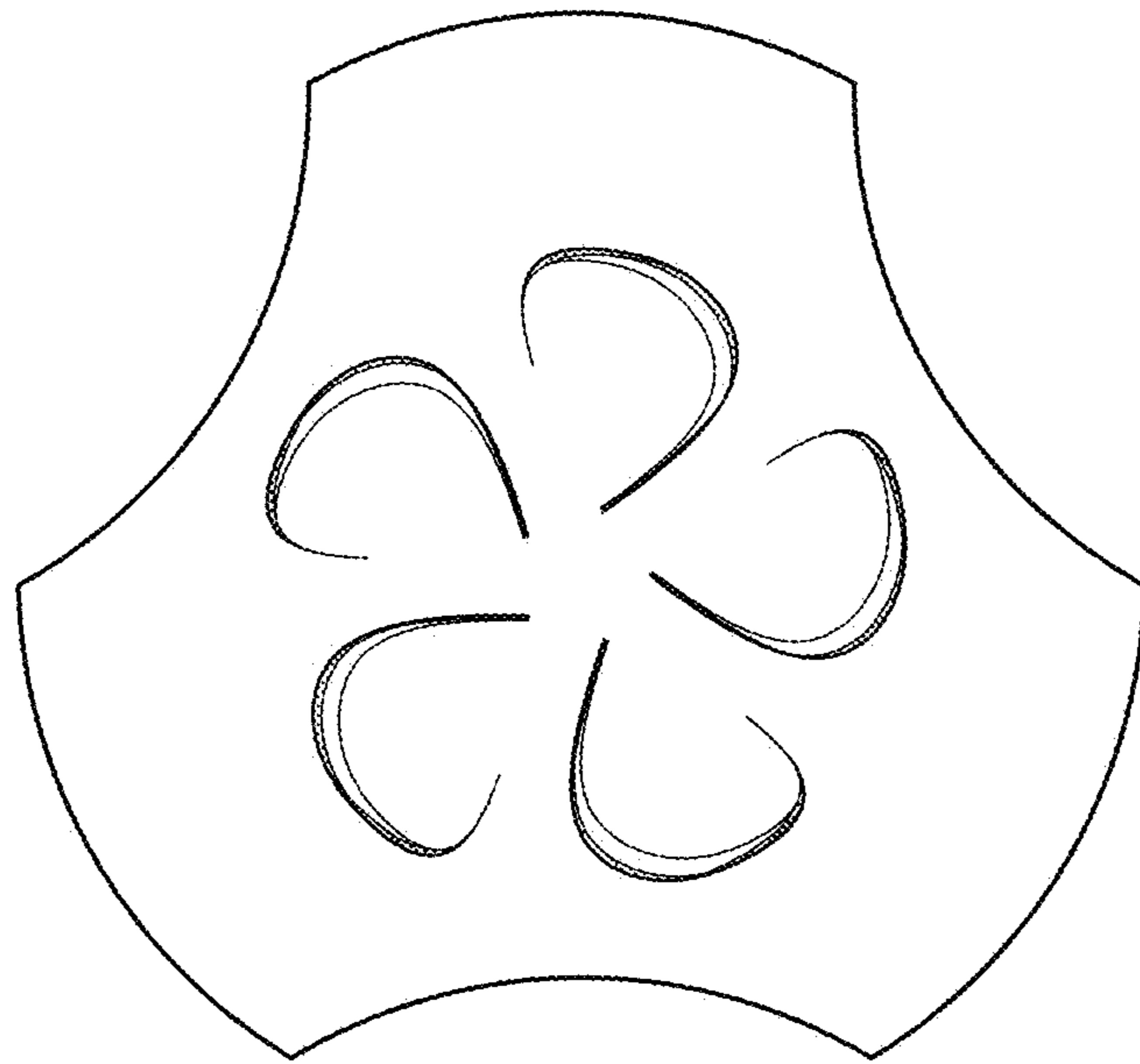

Fig. 16

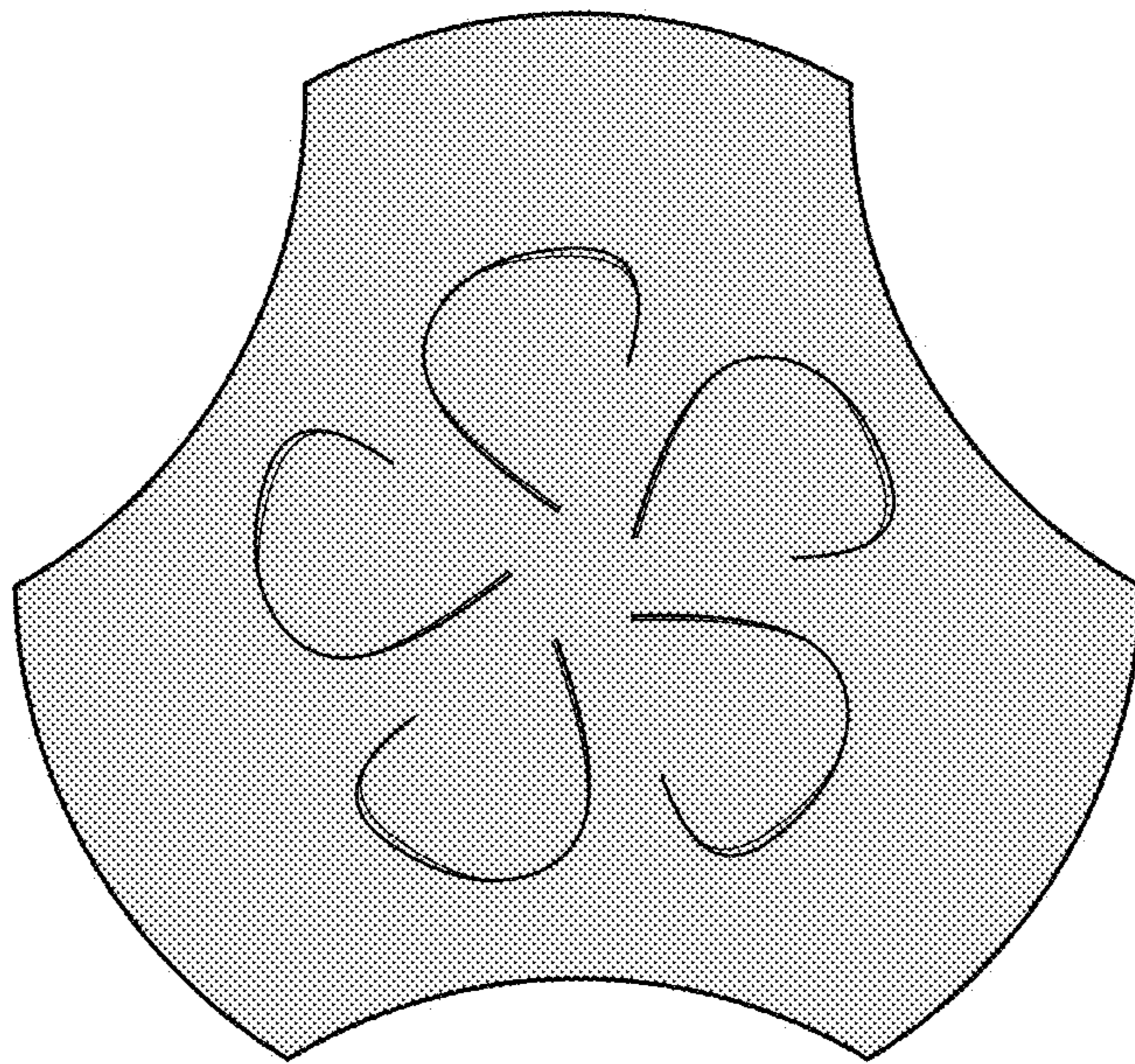

Fig. 17

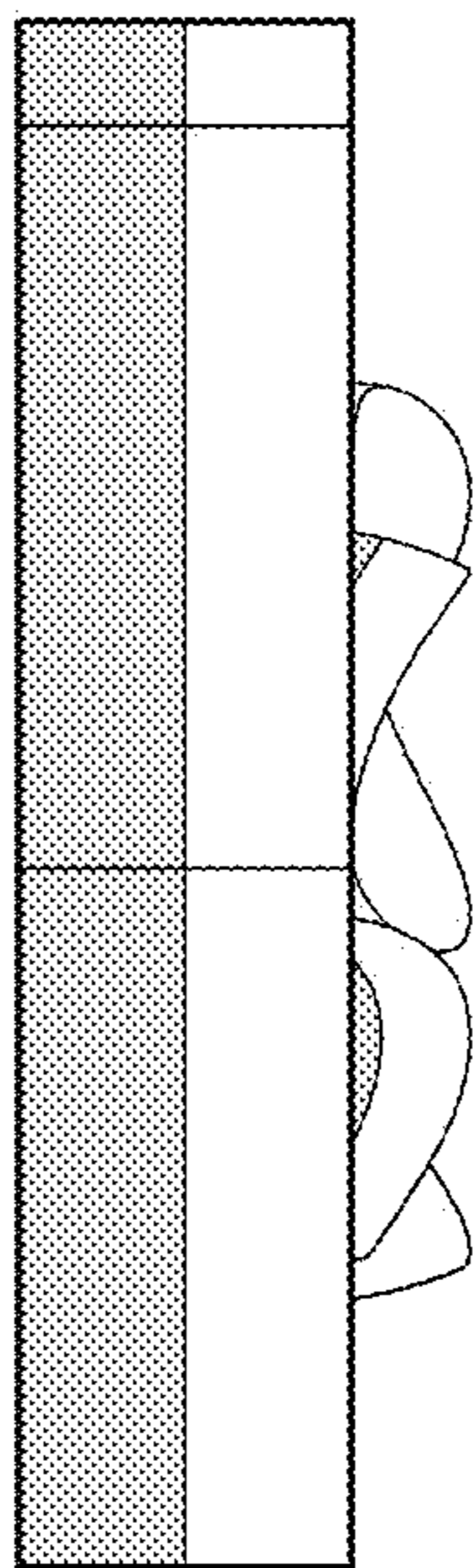

Fig. 18

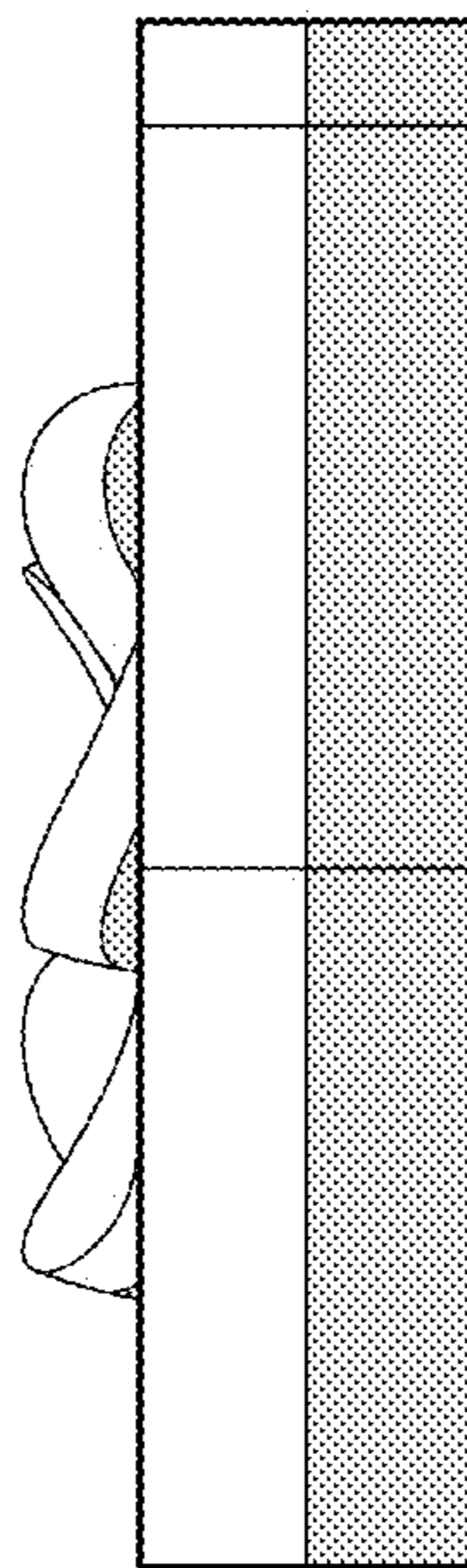

Fig. 19

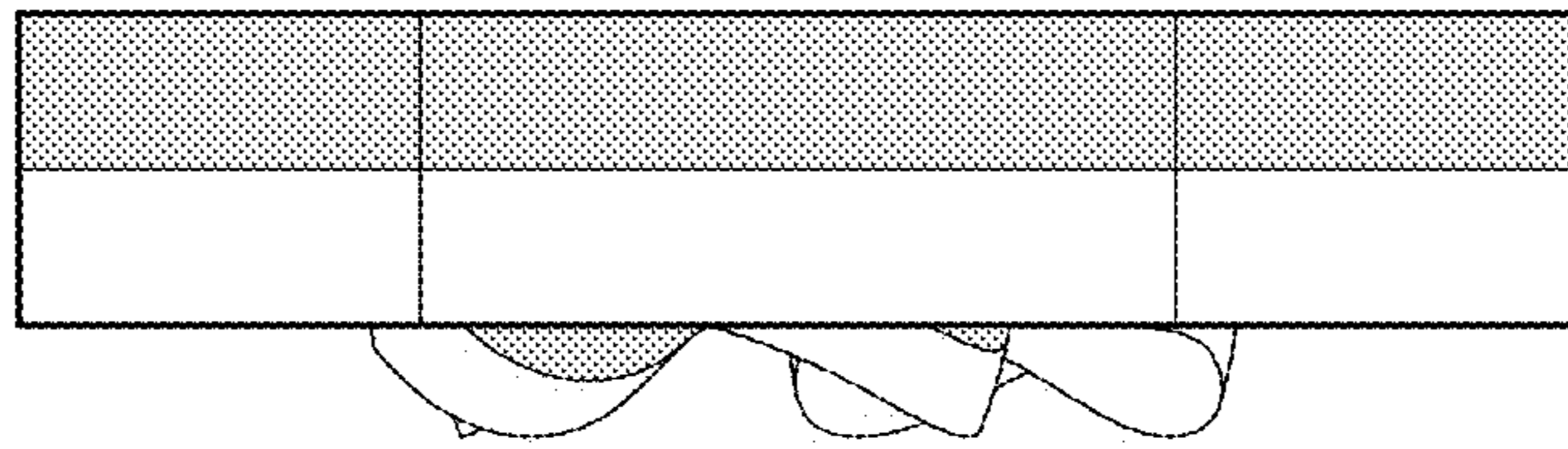

Fig. 20

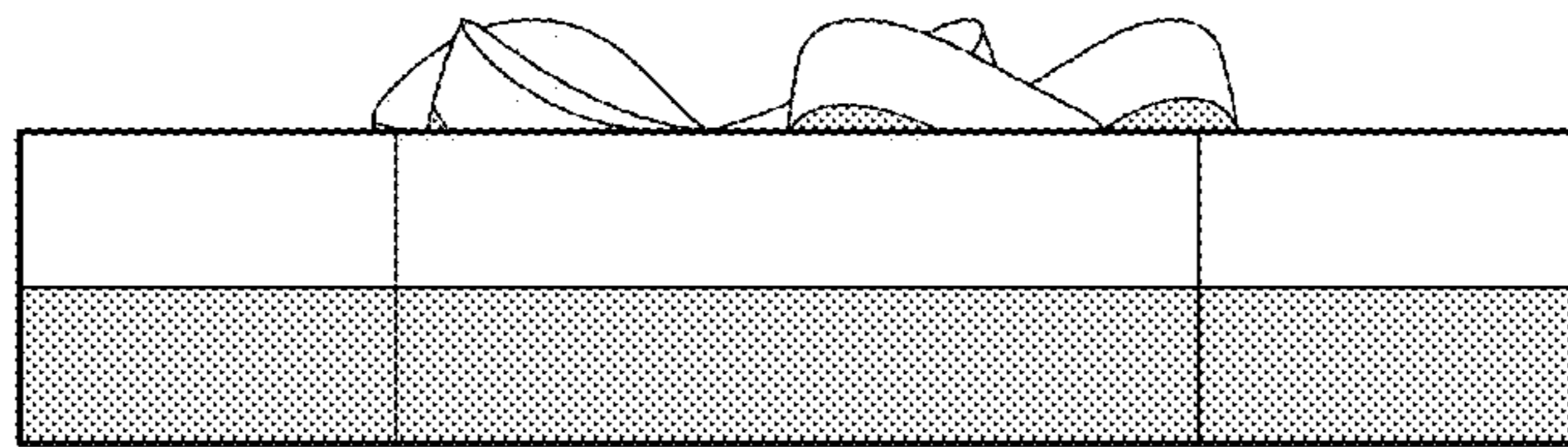

Fig. 21



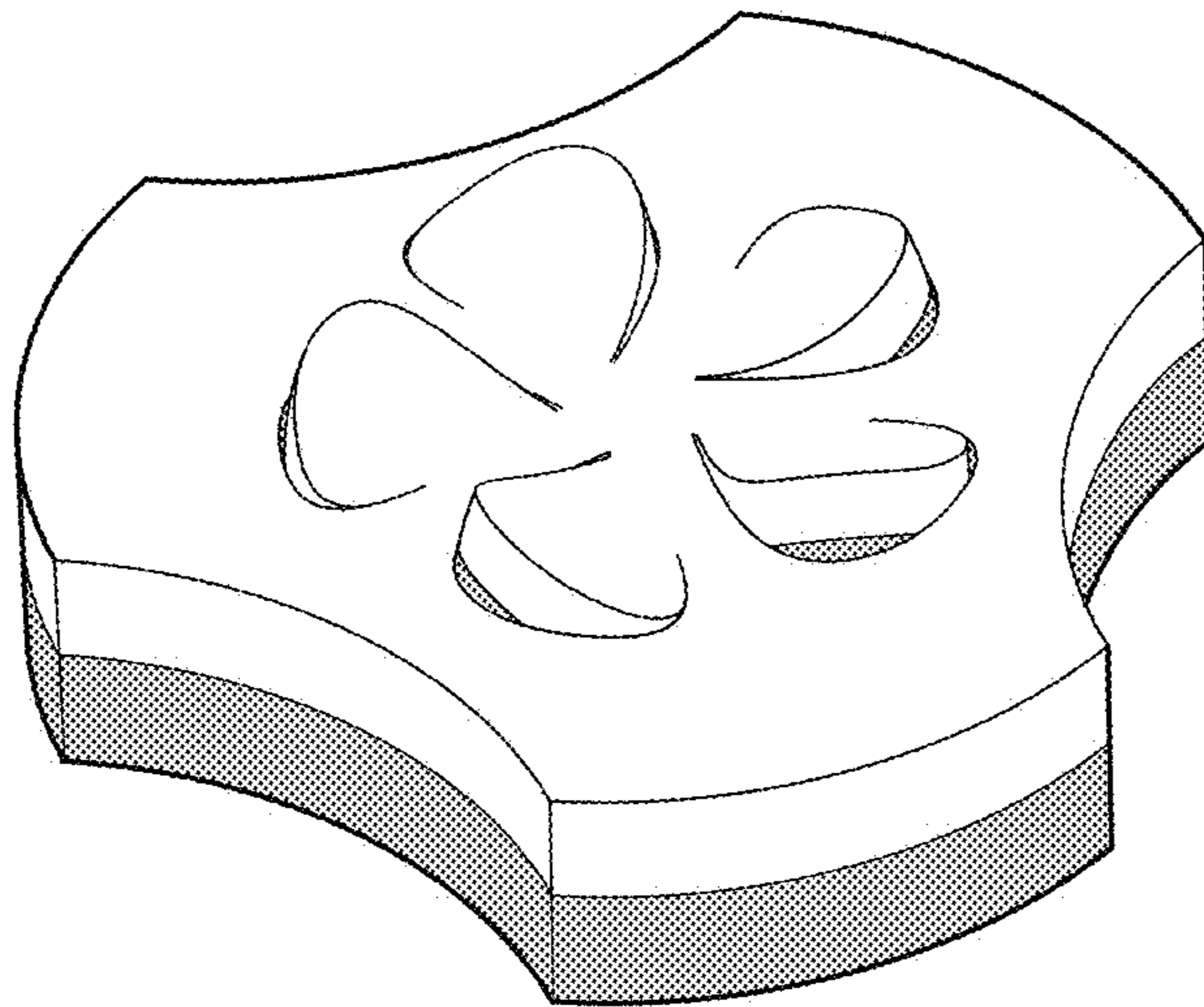

Fig. 22

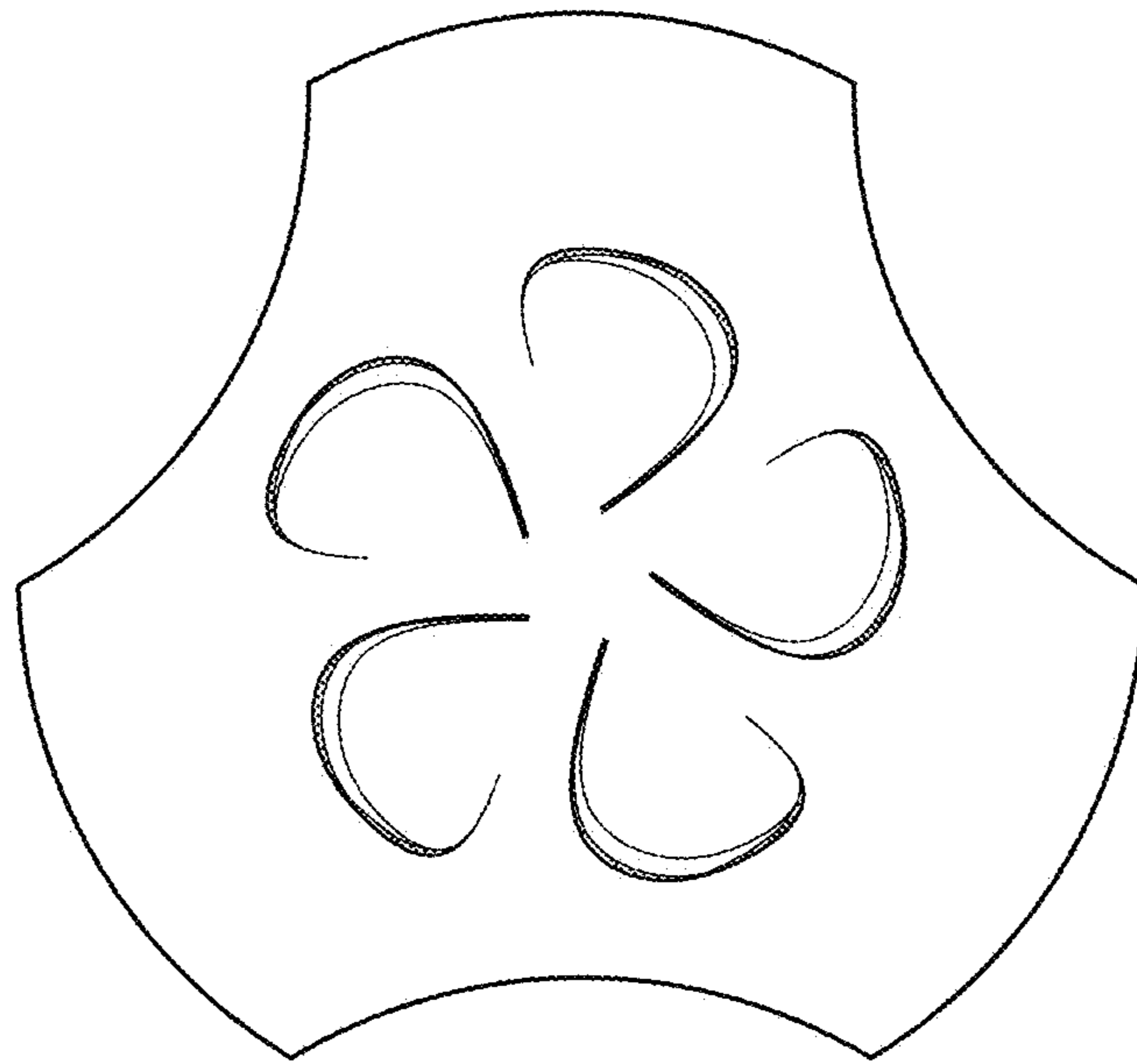

Fig. 23

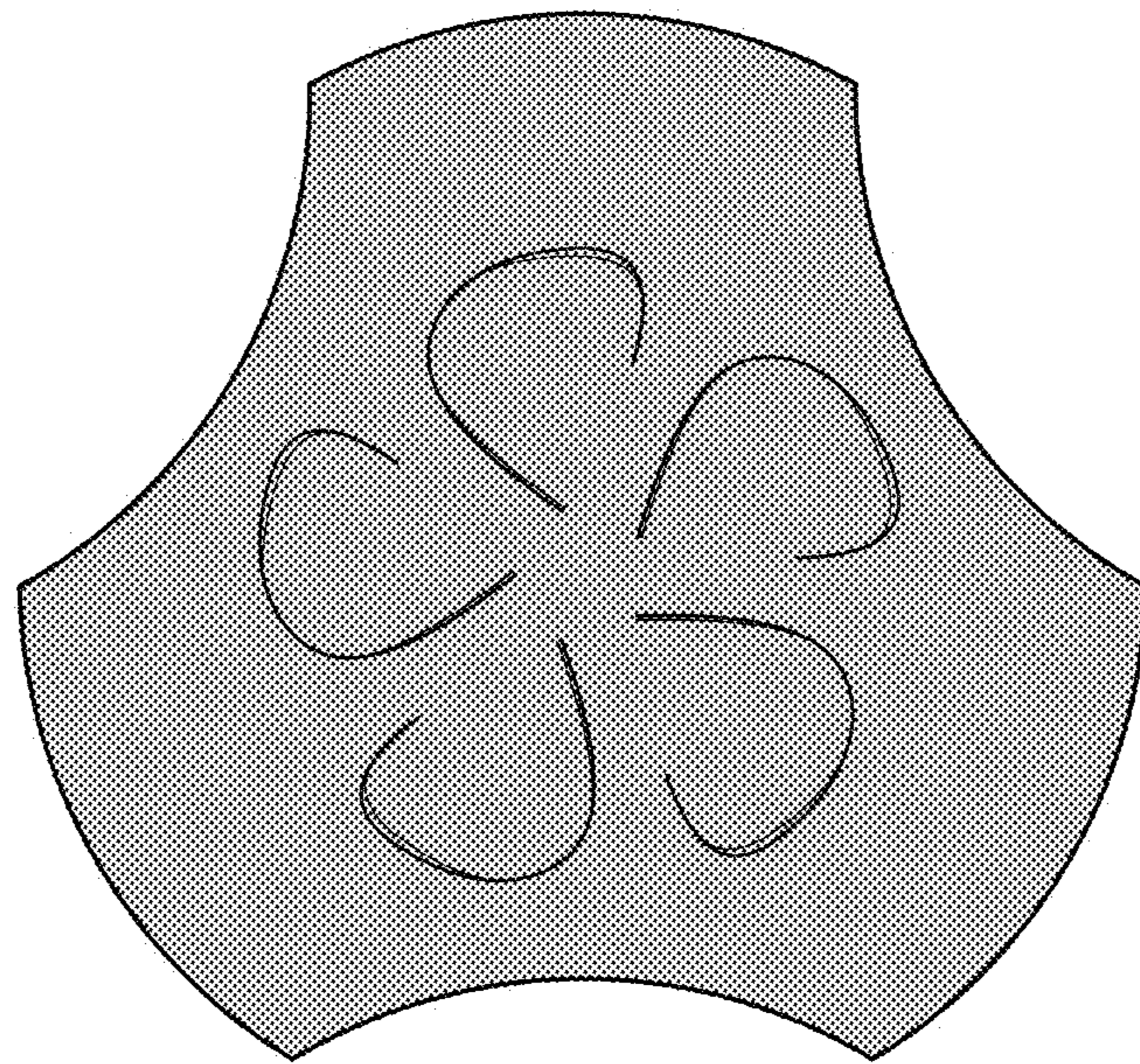

Fig. 24

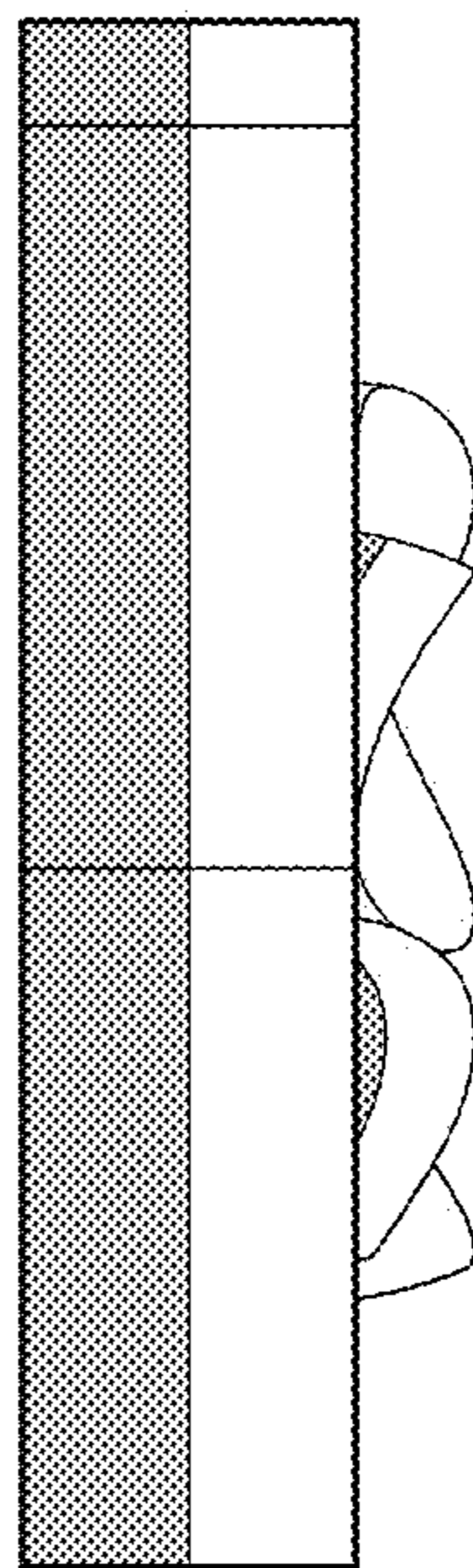

Fig. 25

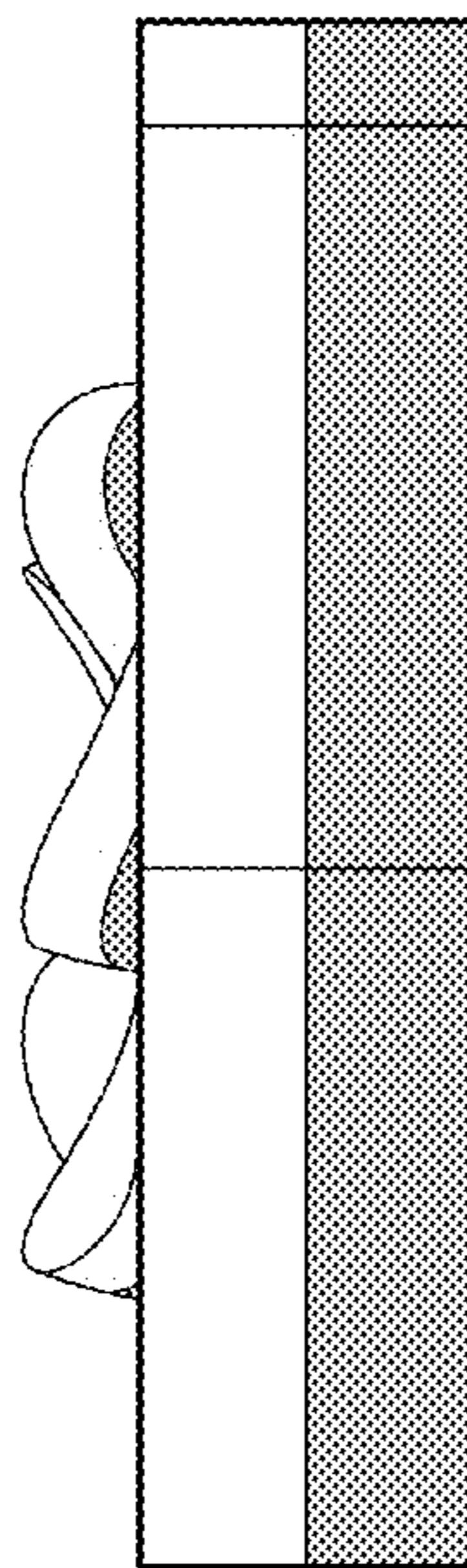

Fig. 26

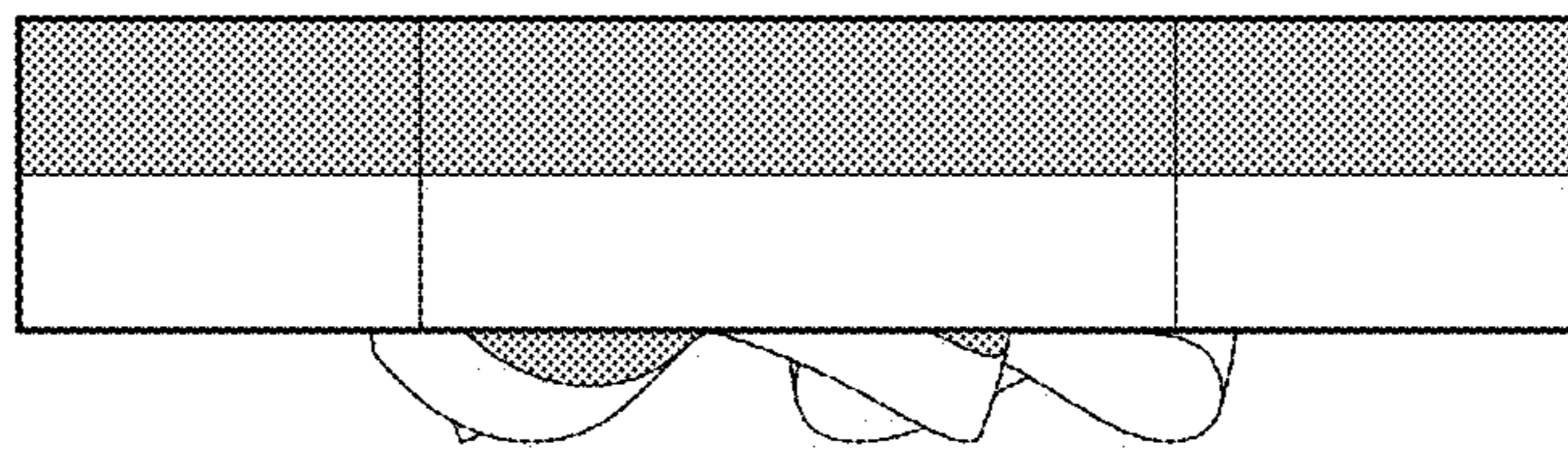

Fig. 27

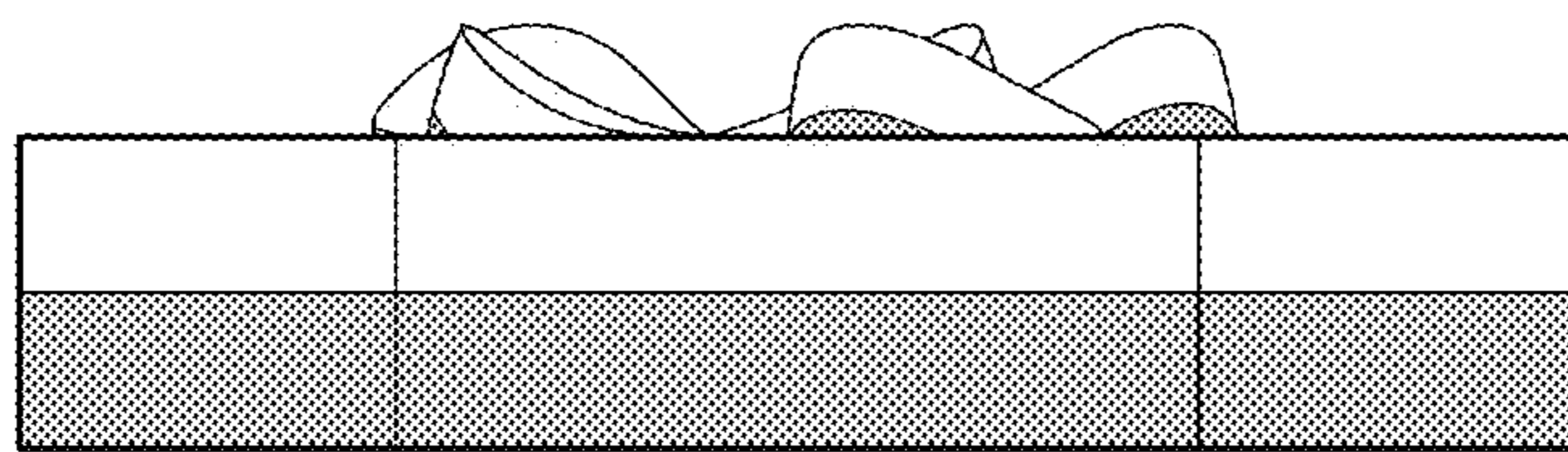

Fig. 28

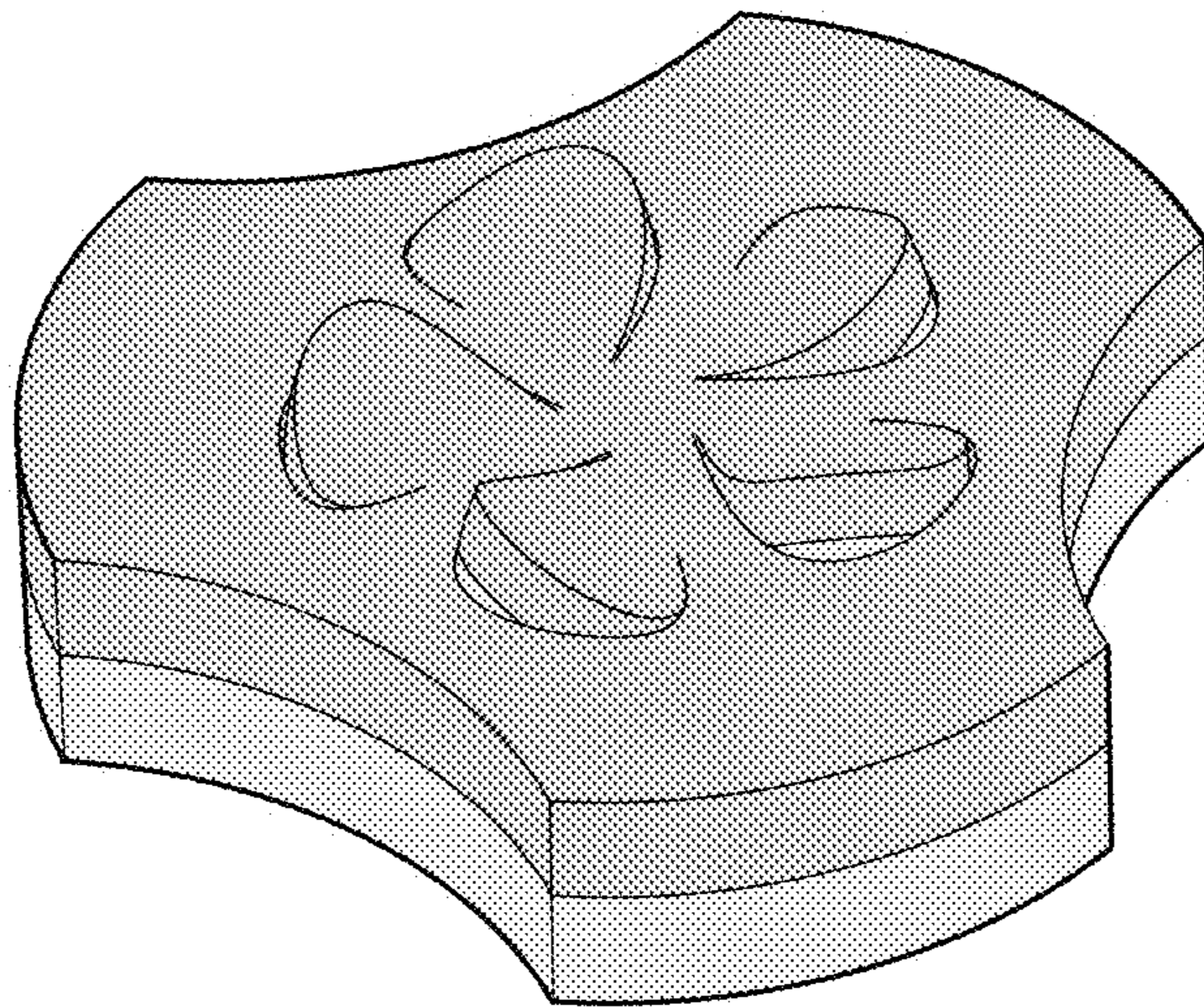

Fig. 29



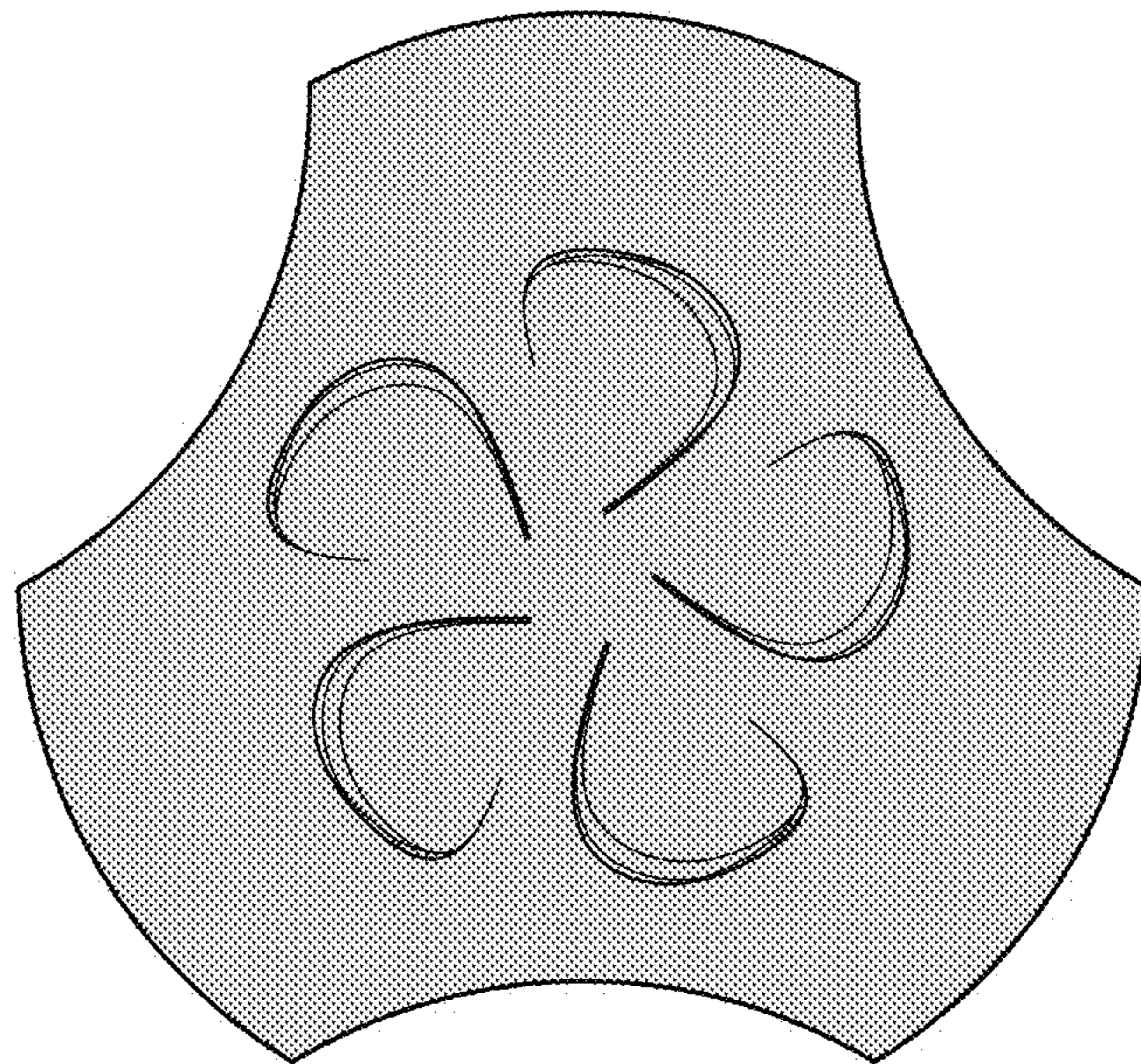

Fig. 30

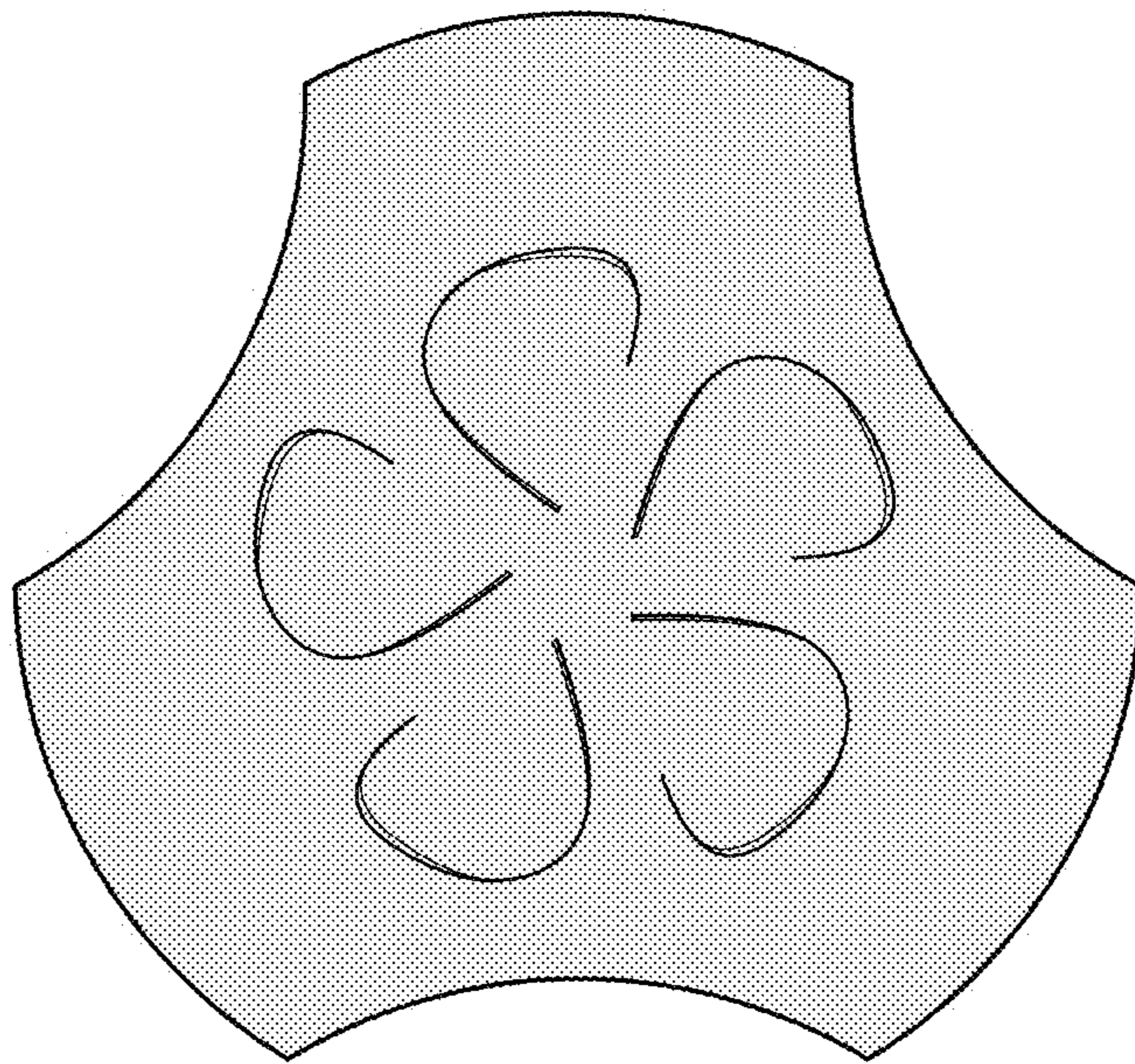

Fig. 31

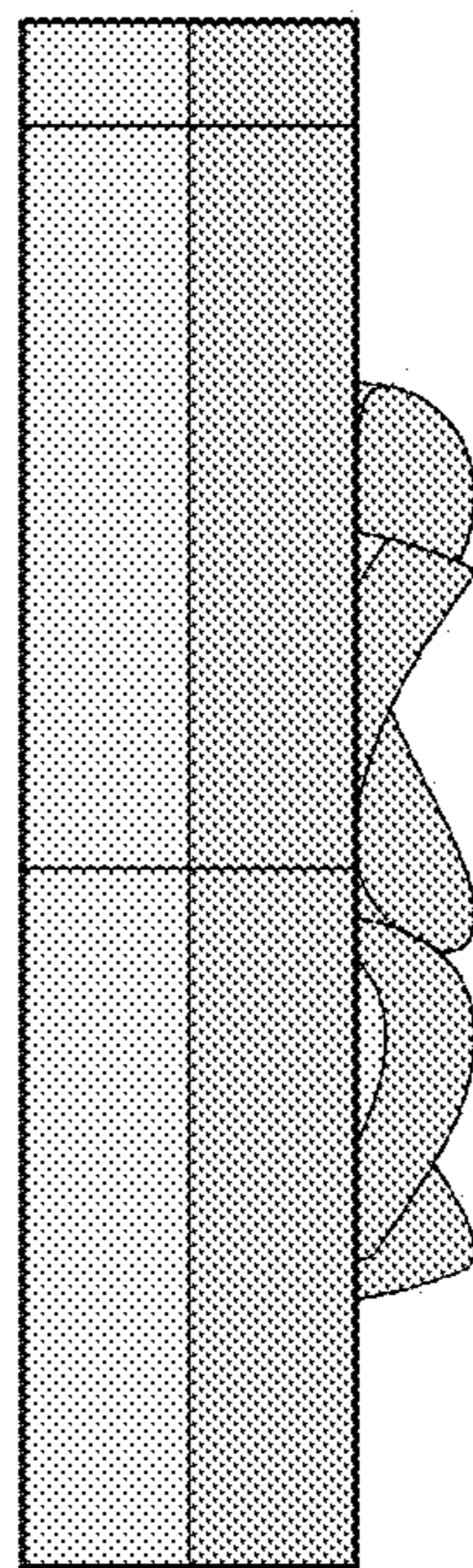

Fig. 32

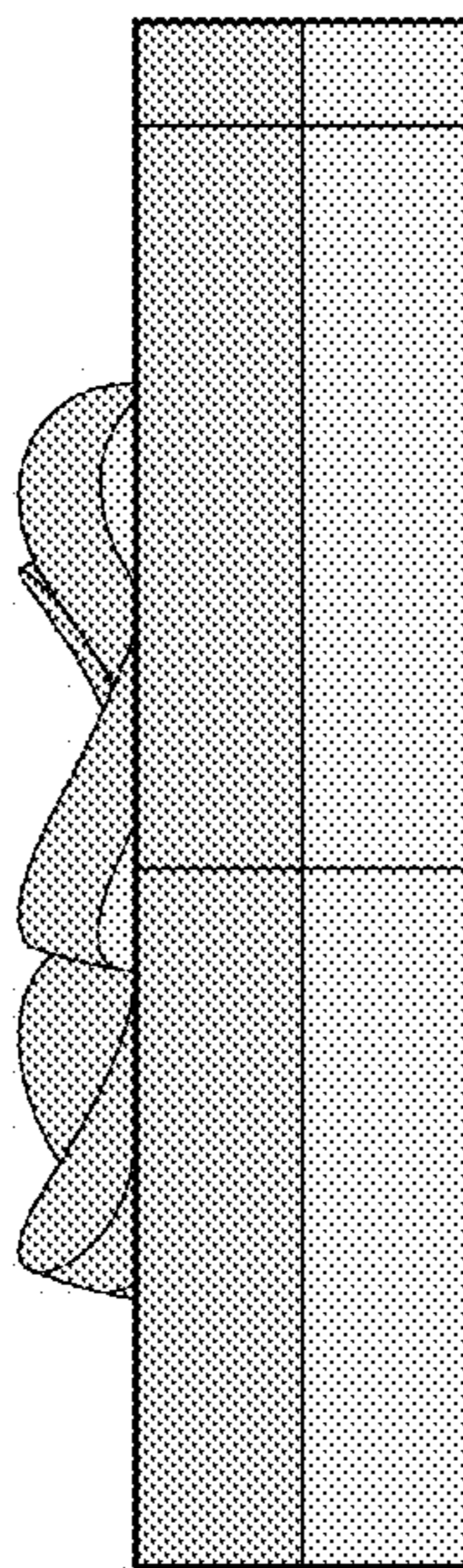

Fig. 33

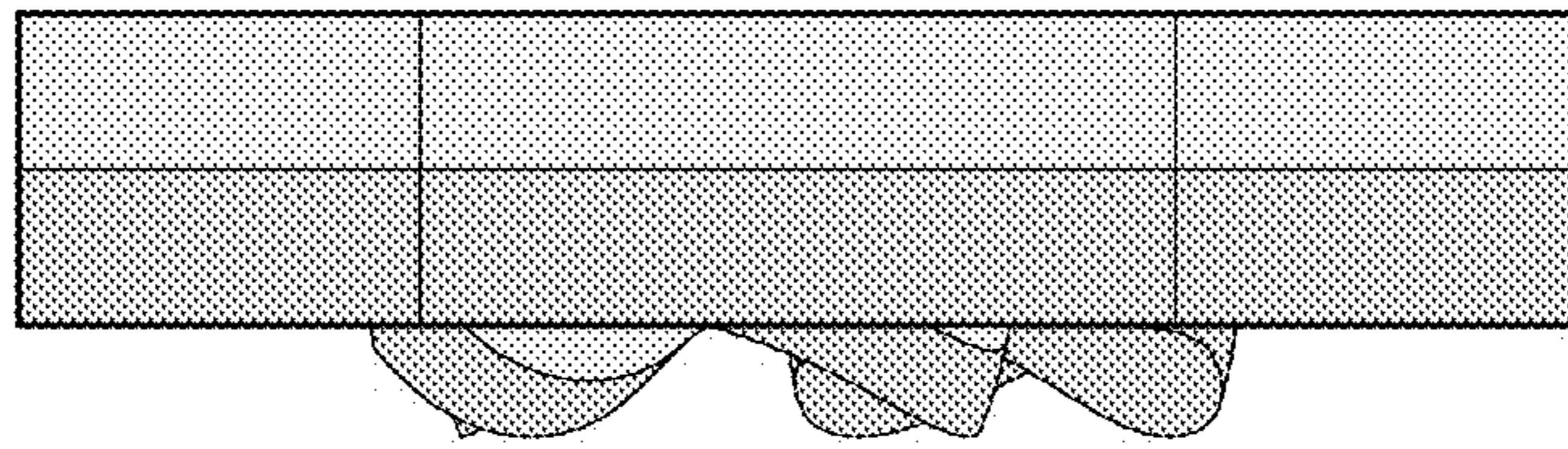

Fig. 34

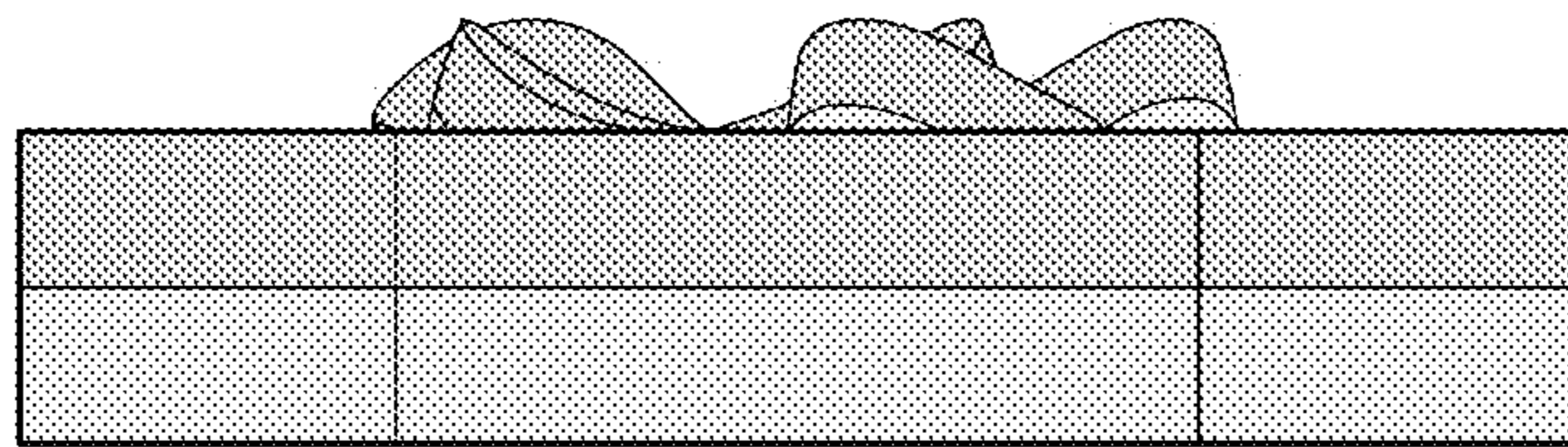

Fig. 35

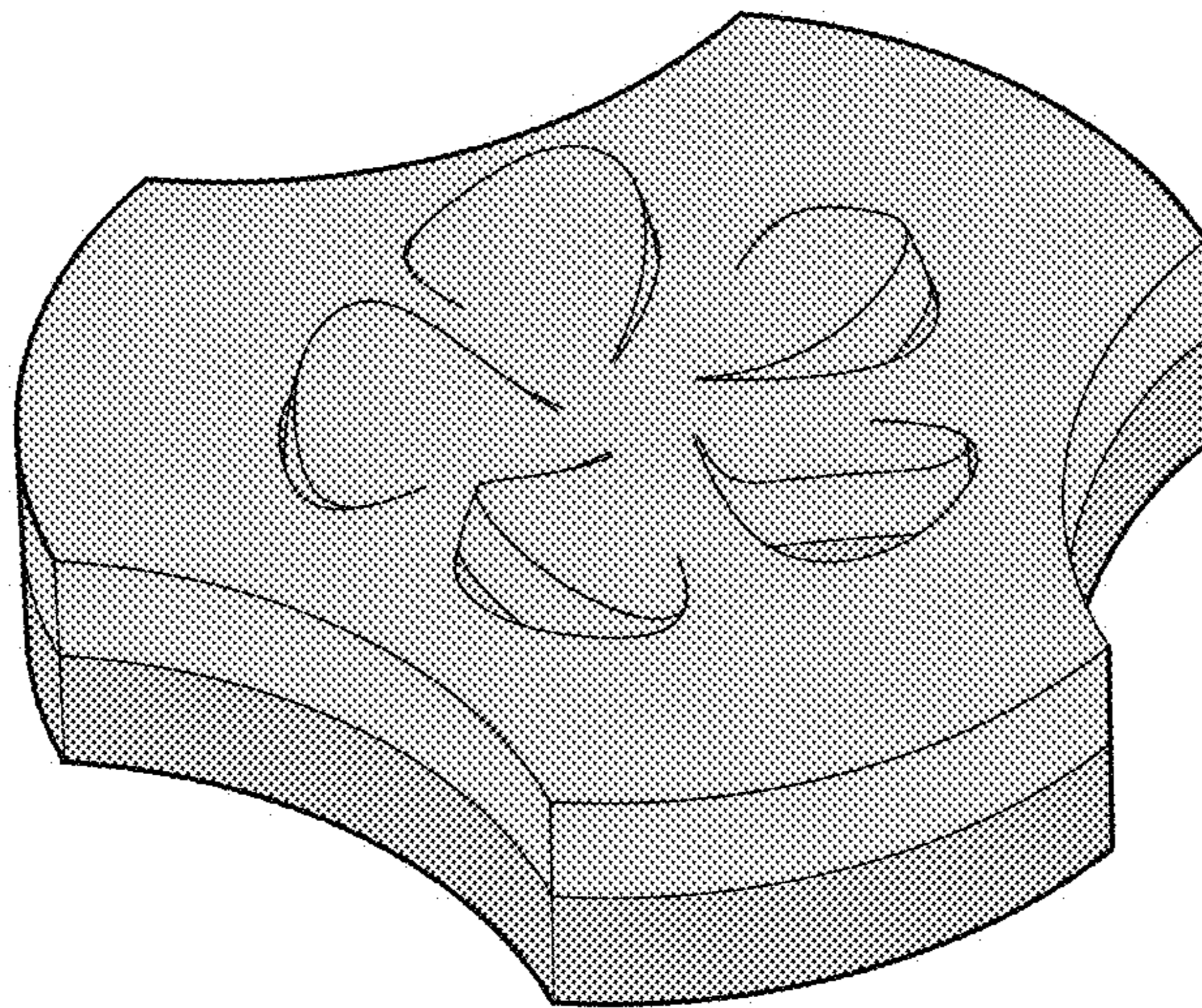

Fig. 36

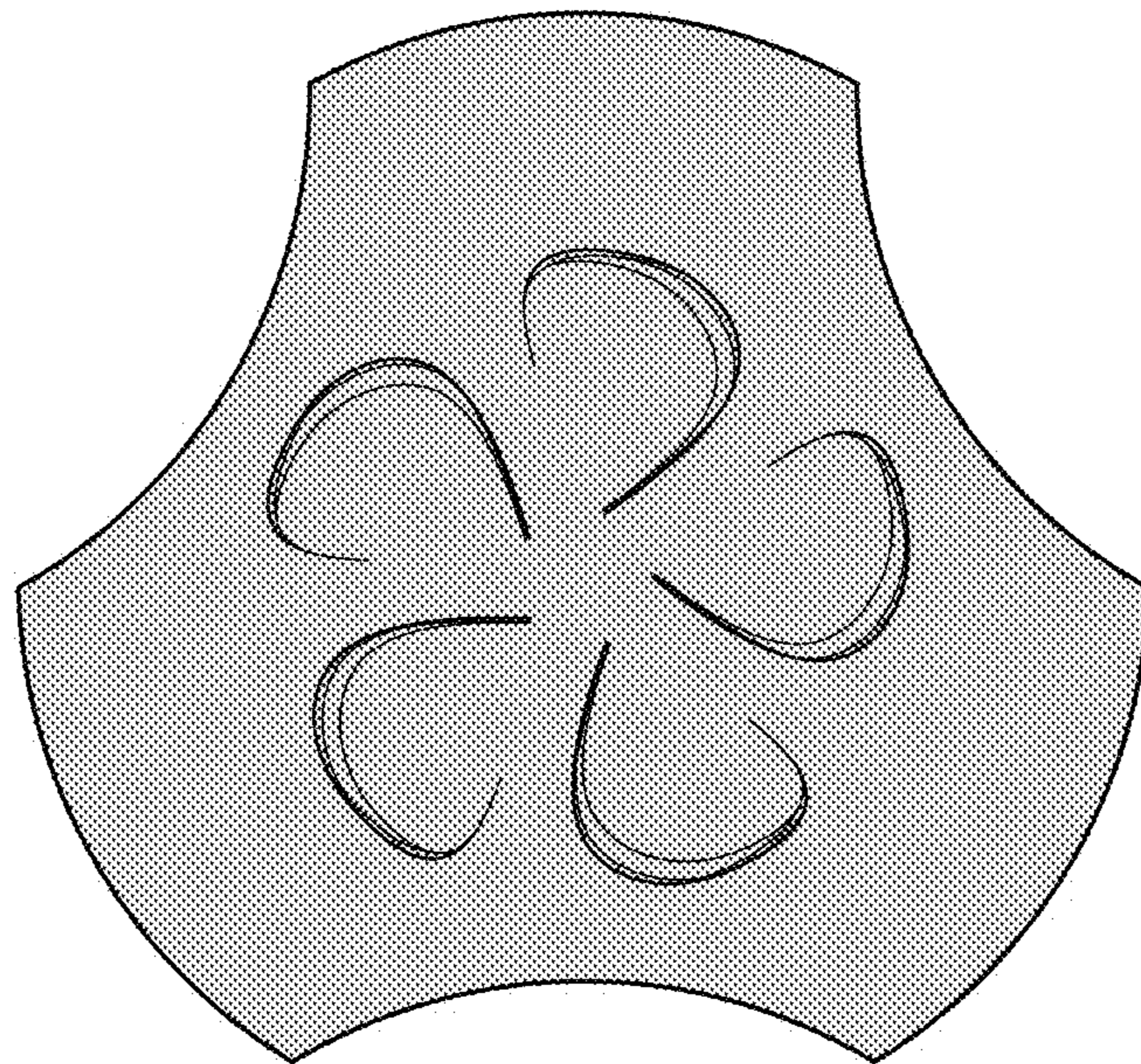

Fig. 37



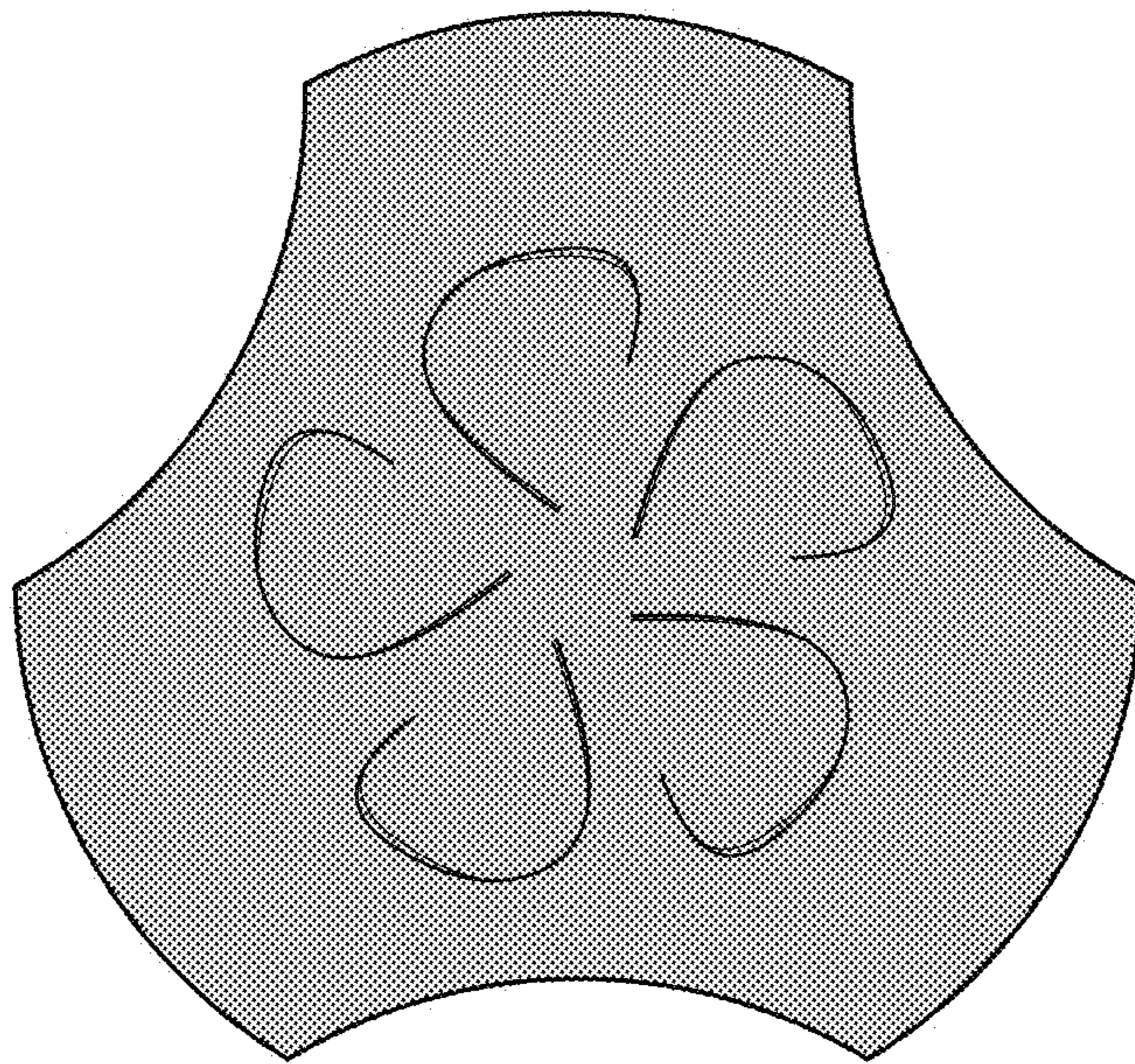

Fig. 38

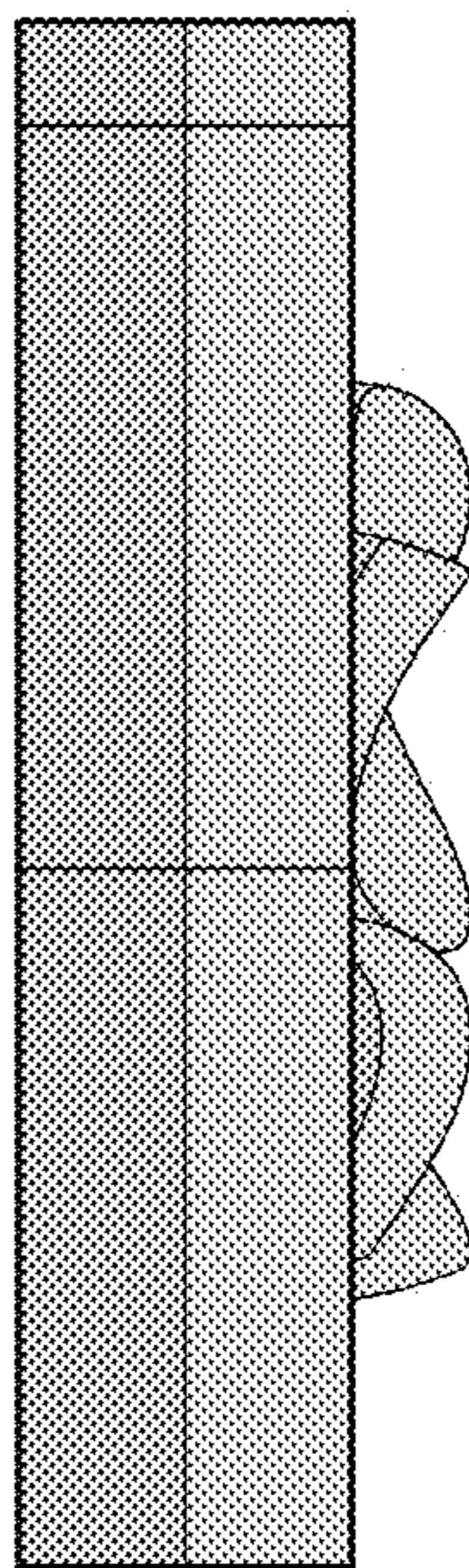

Fig. 39

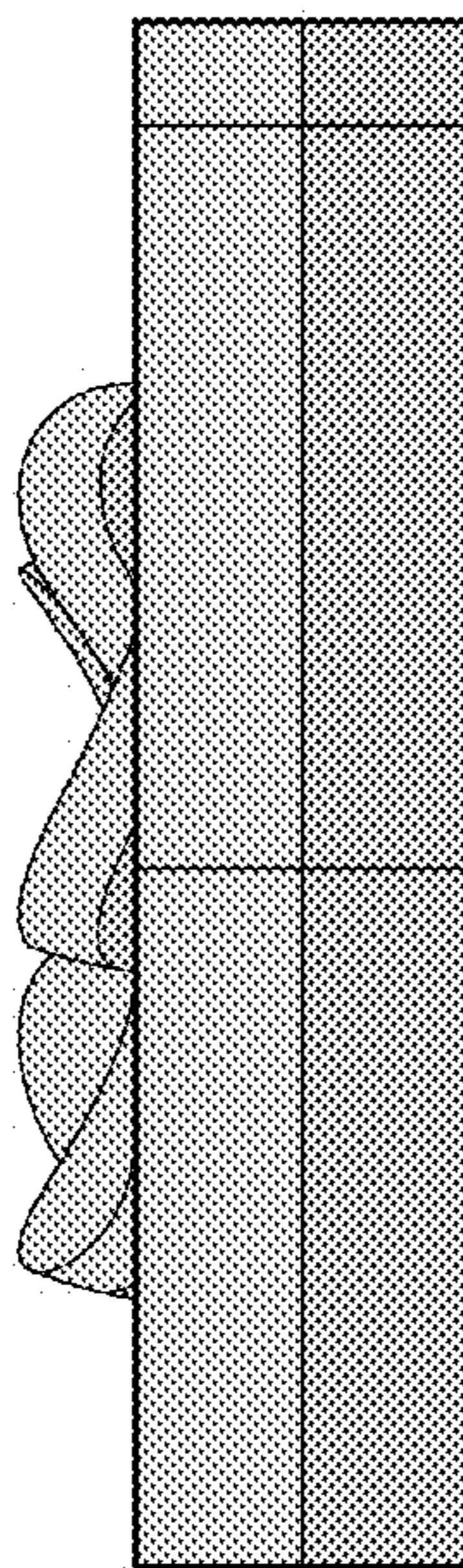

Fig. 40

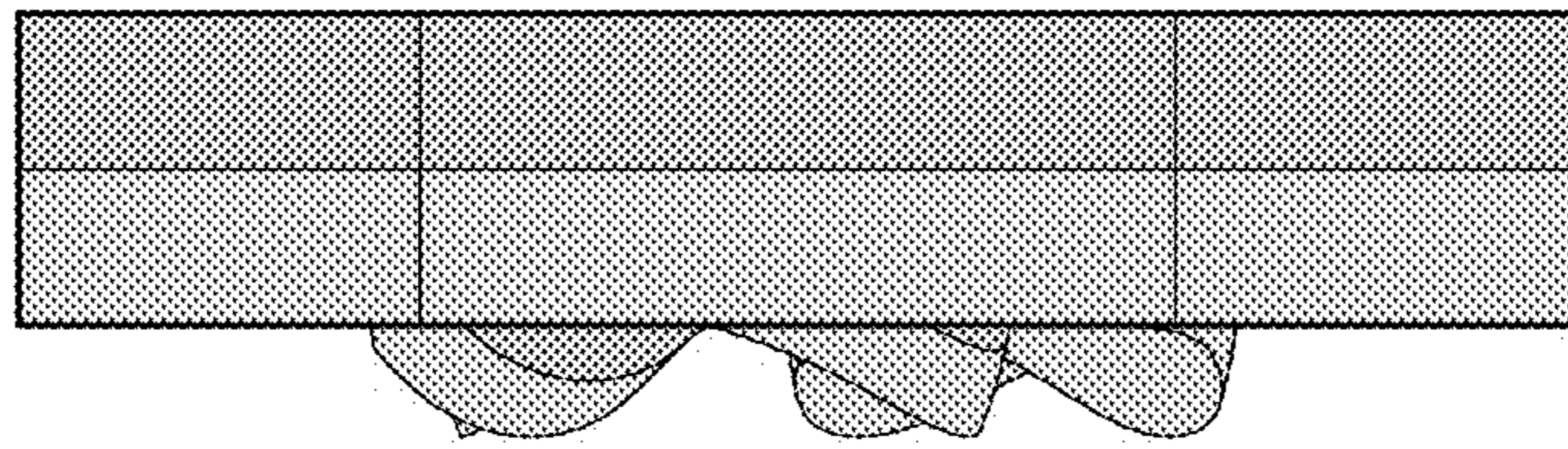

Fig. 41

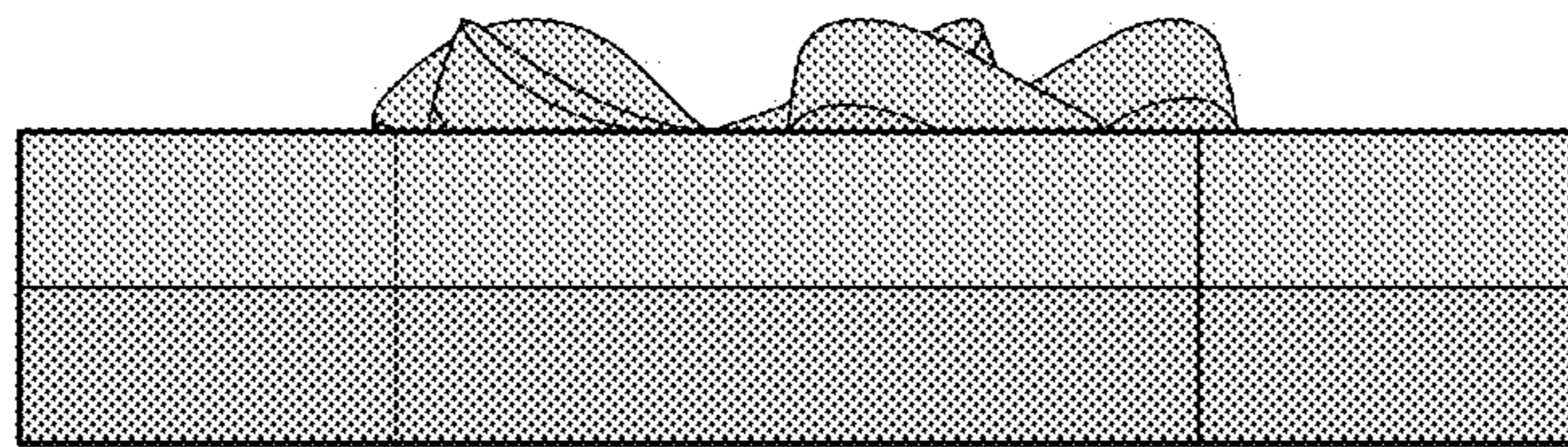

Fig. 42

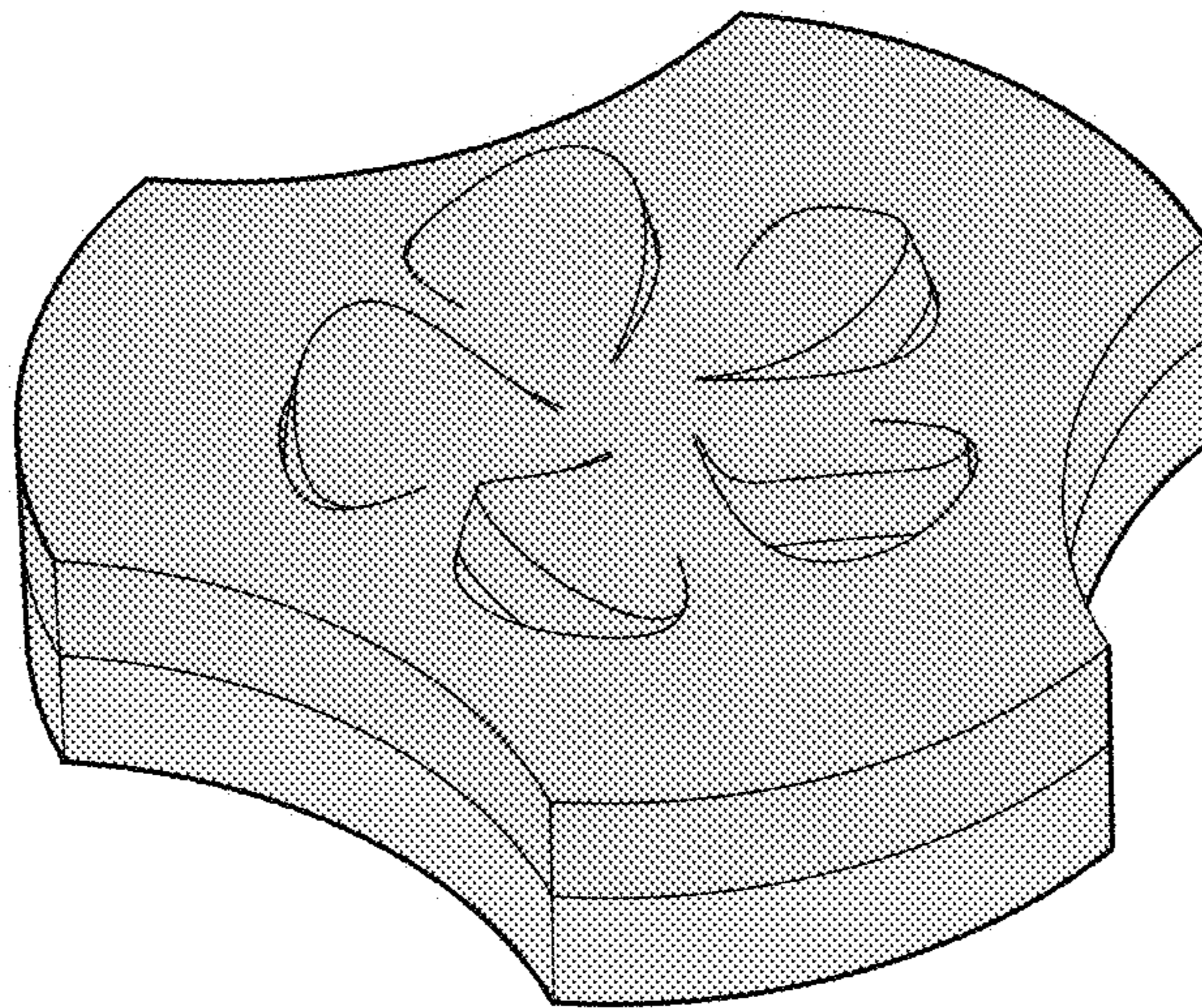

Fig. 43

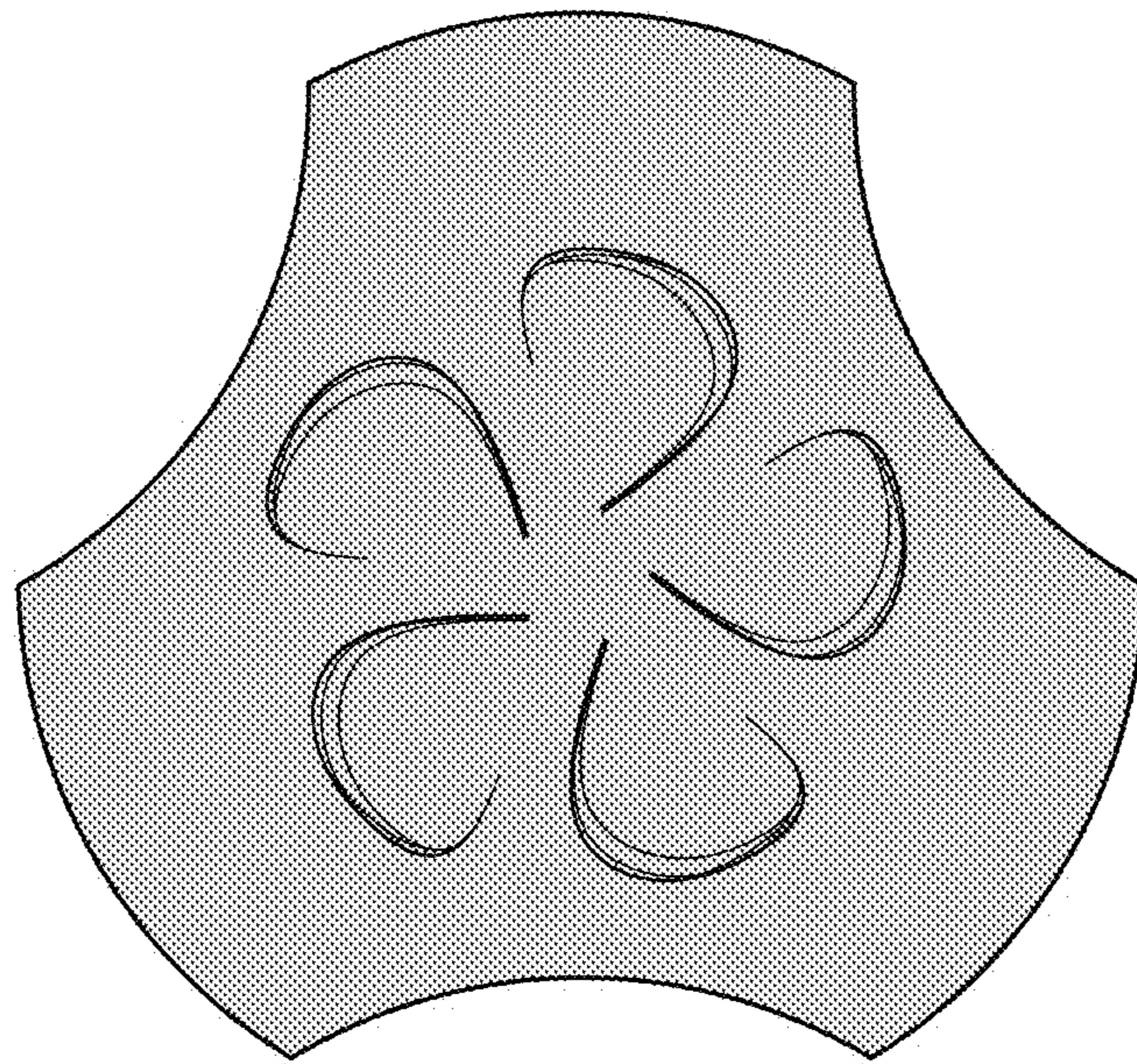

Fig. 44

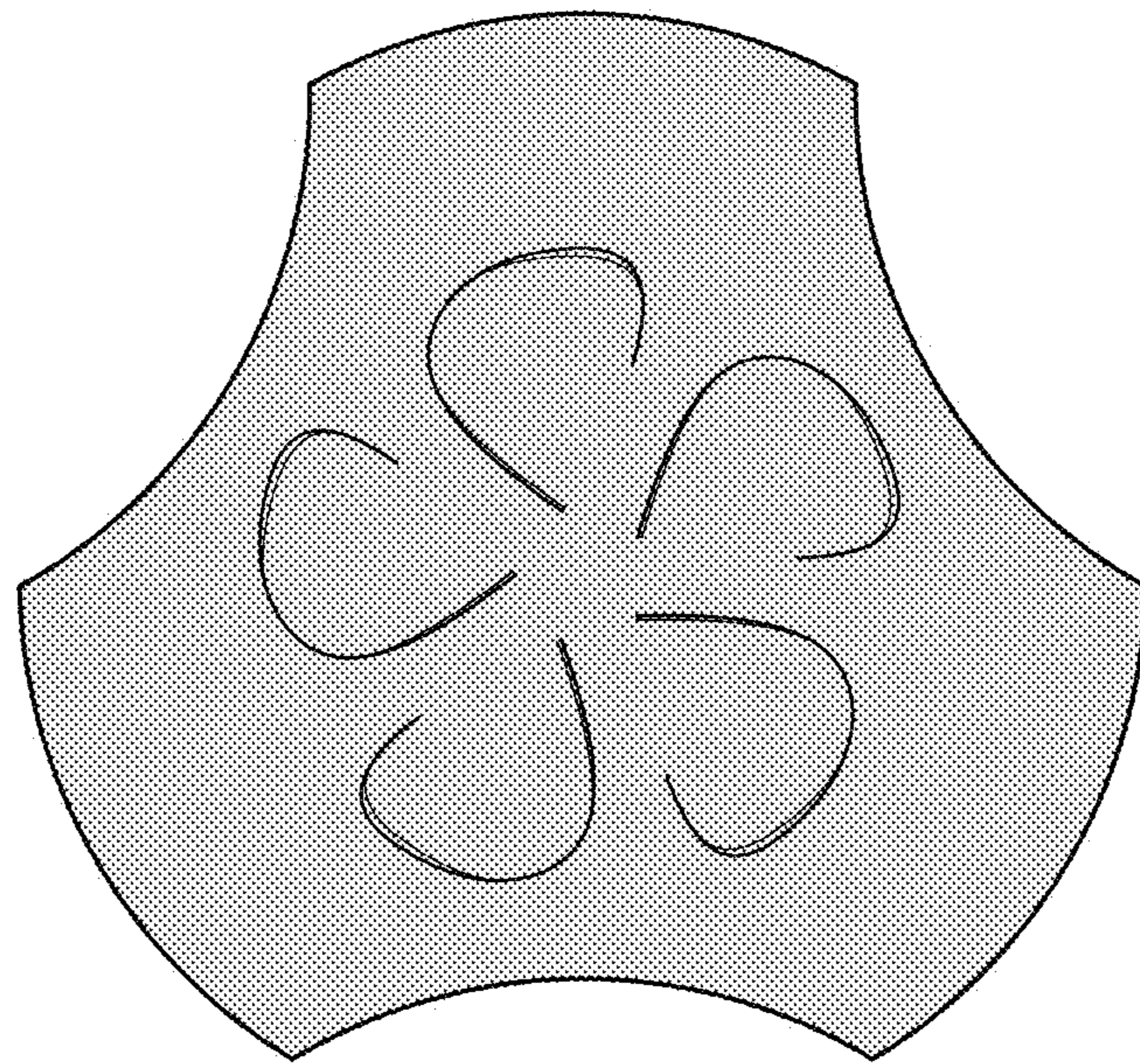

Fig. 45



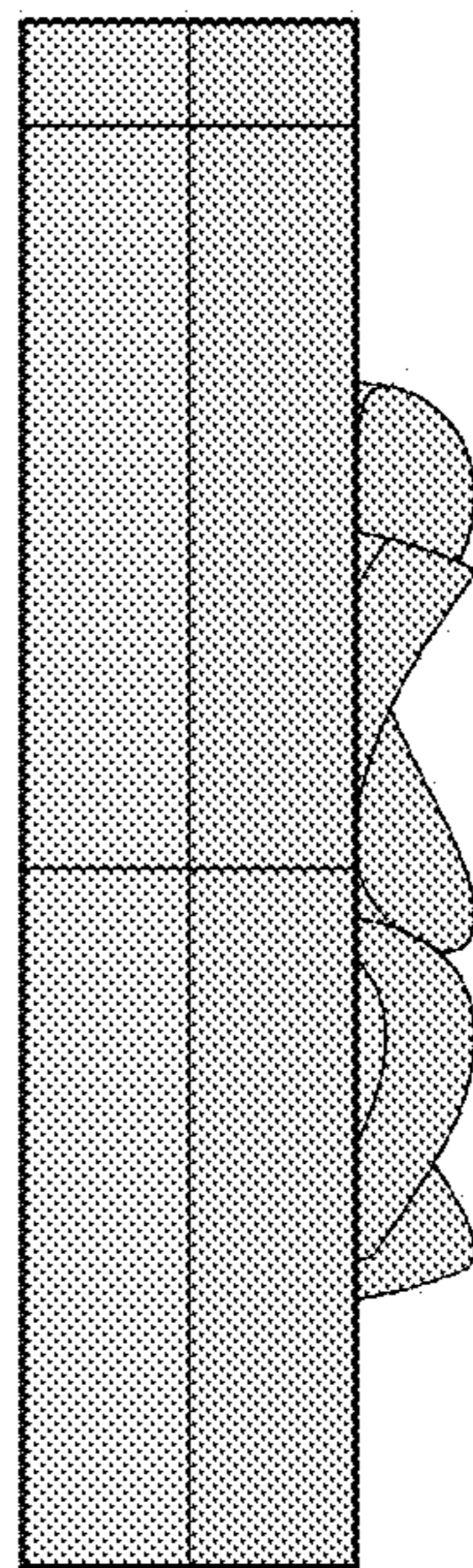

Fig. 46

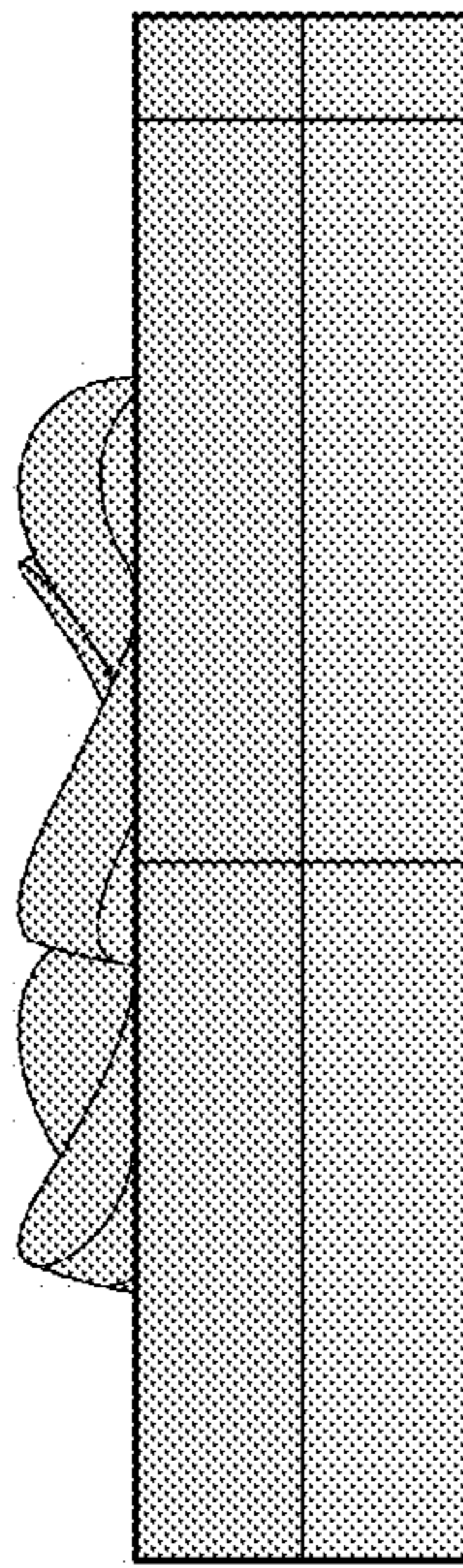

Fig. 47

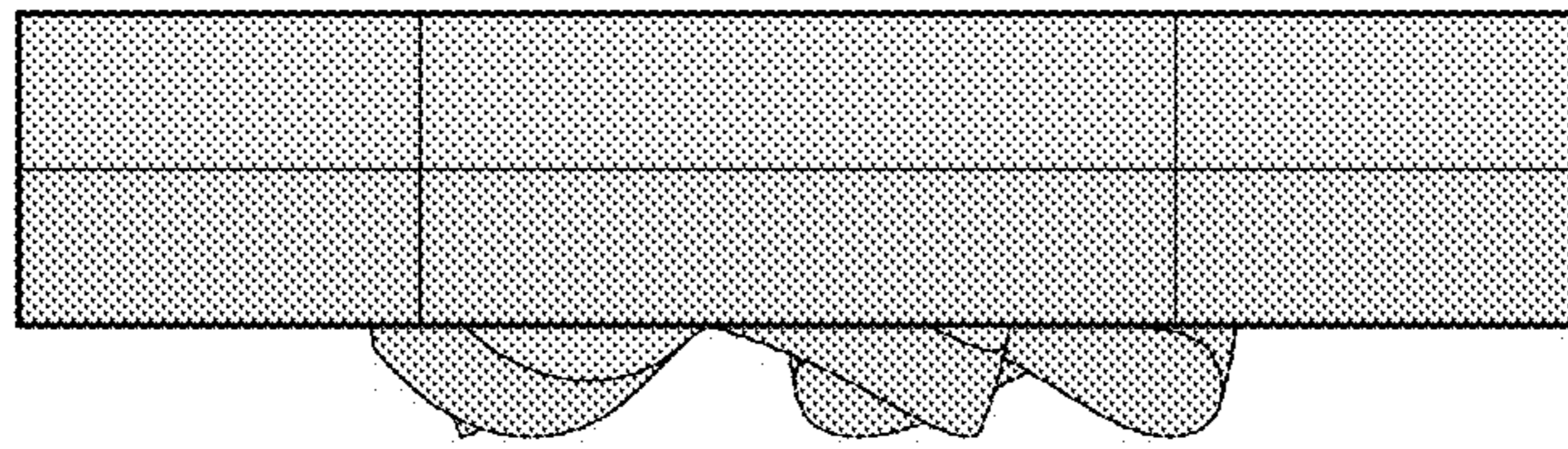

Fig. 48

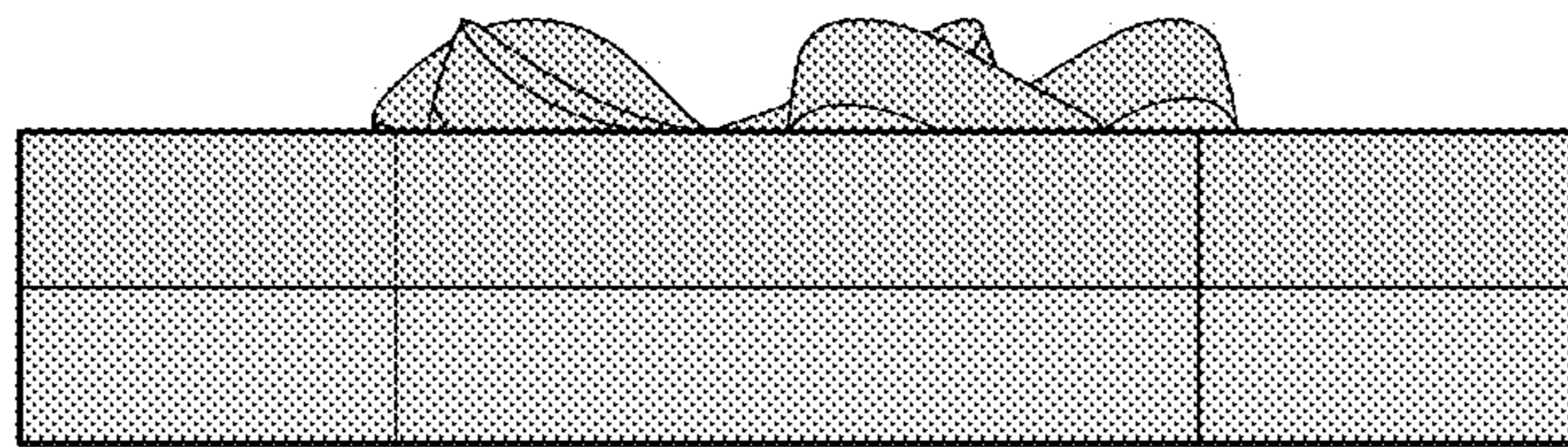

Fig. 49

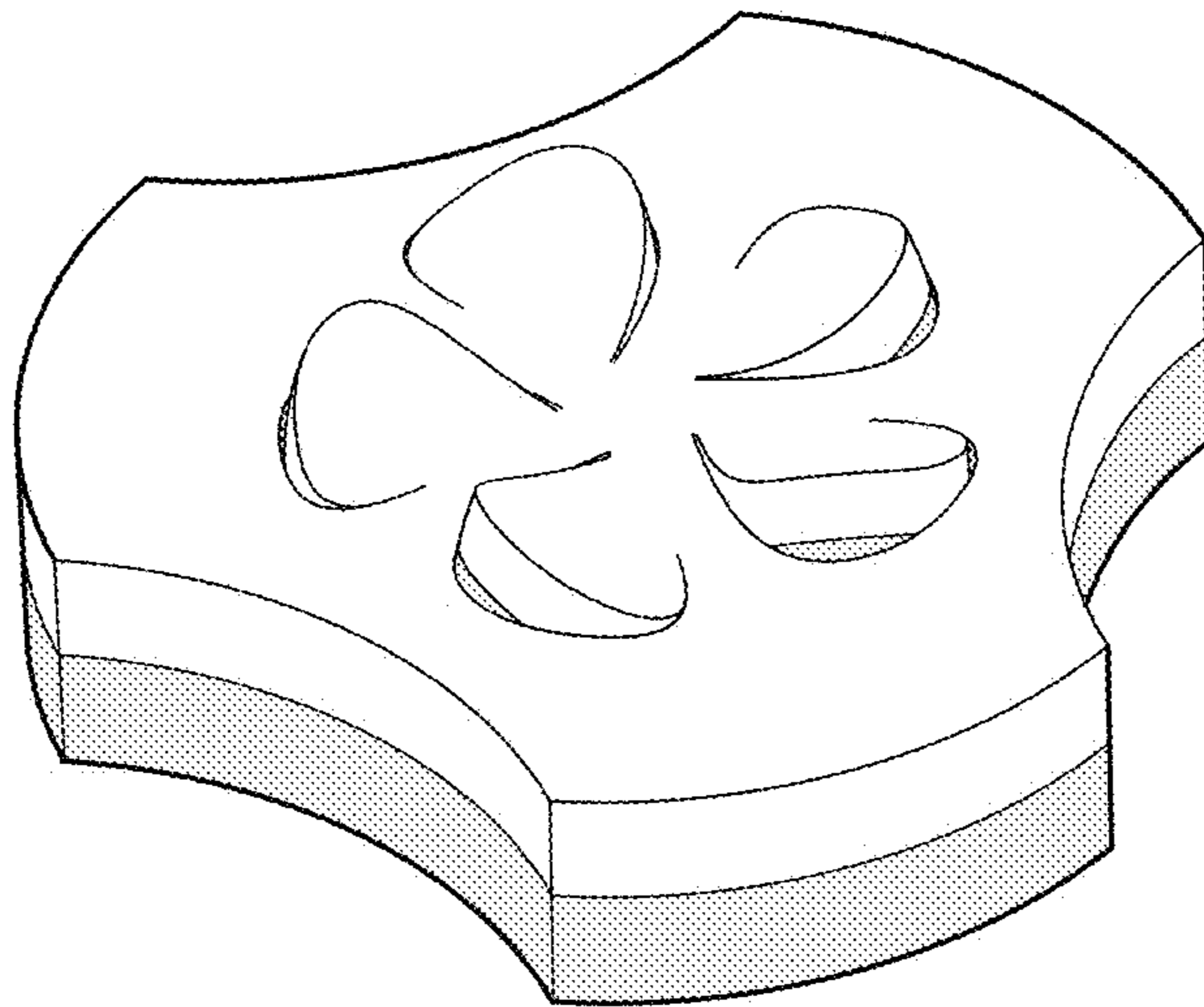

Fig. 50

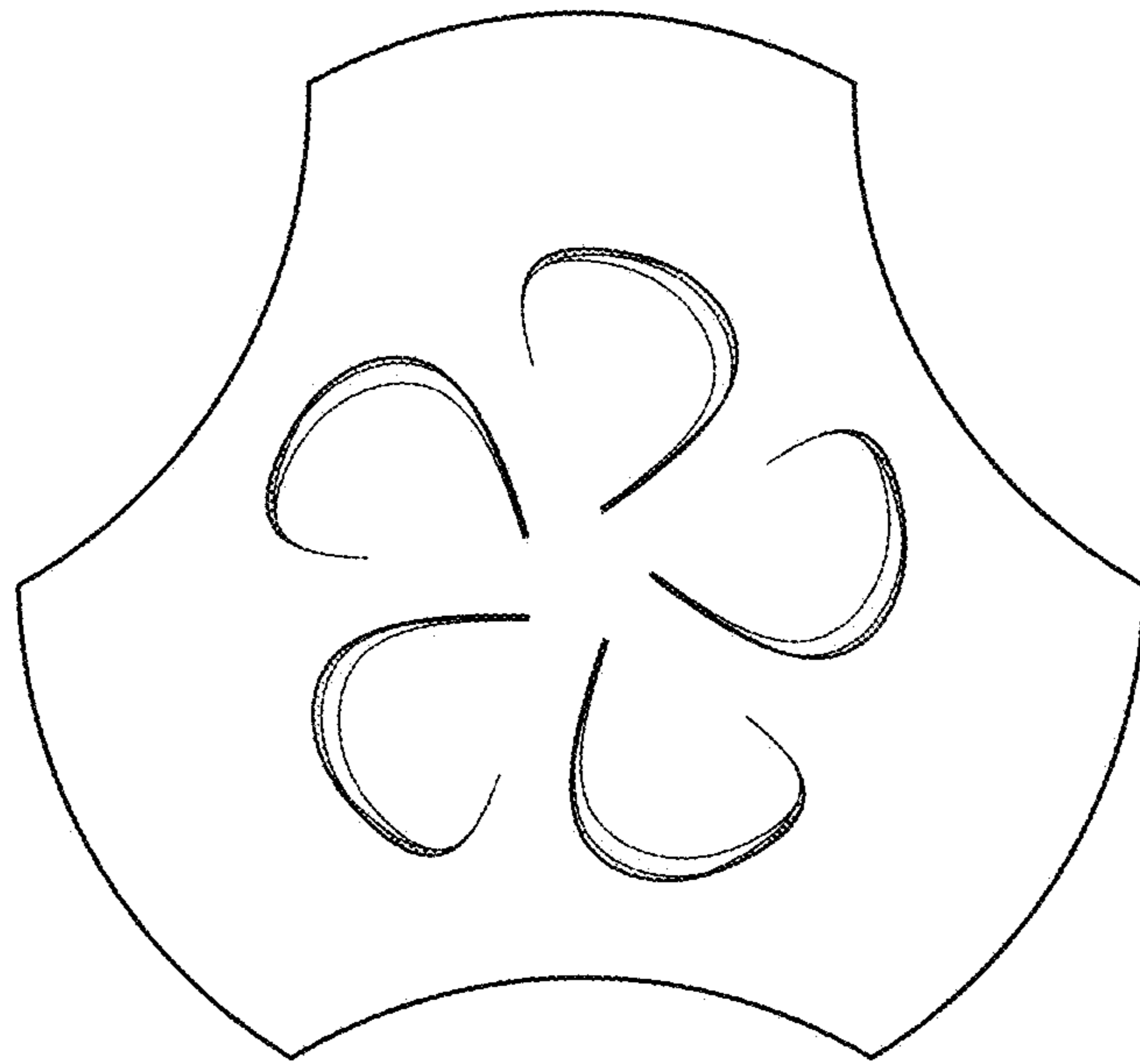

Fig. 51

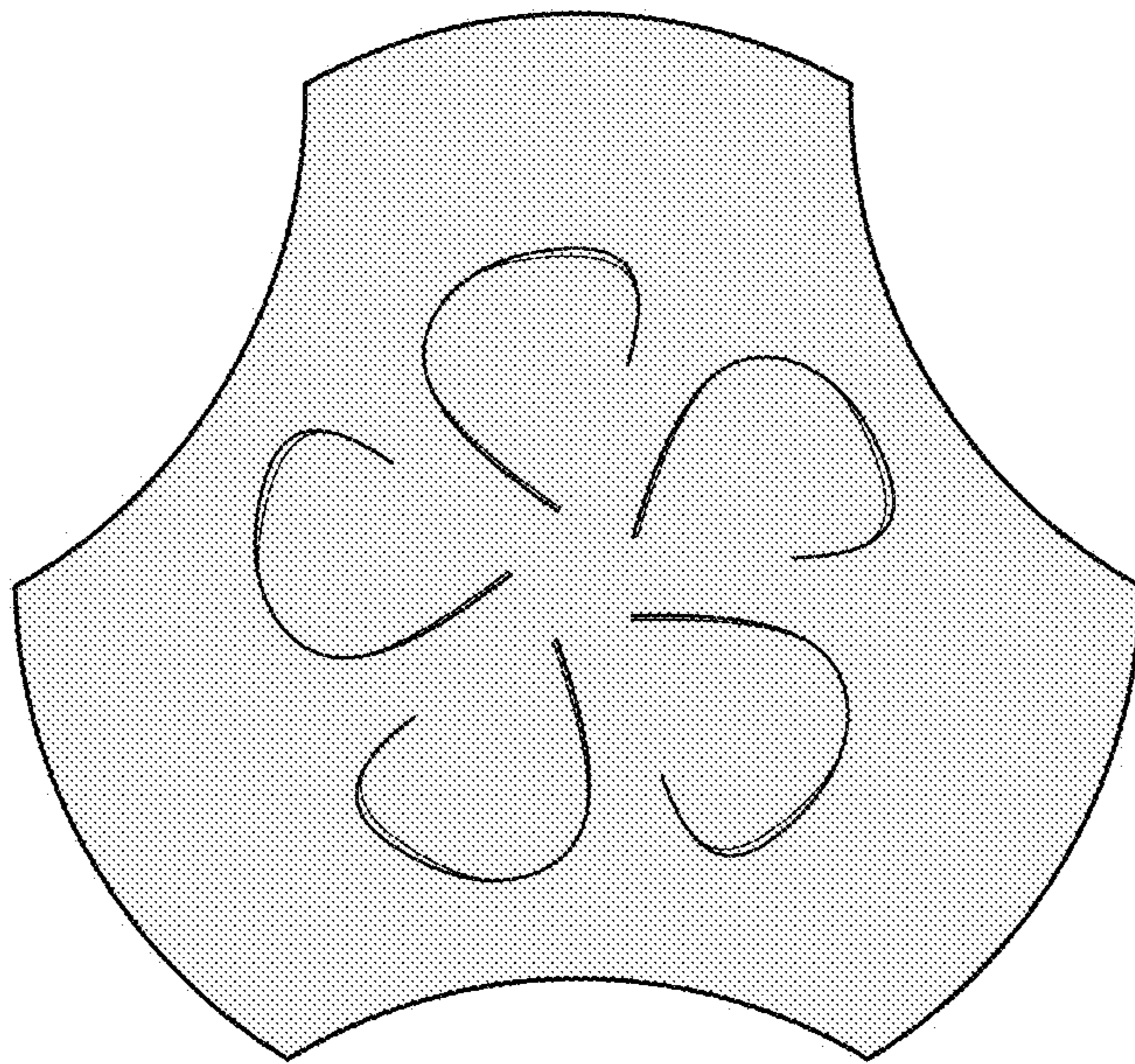

Fig. 52

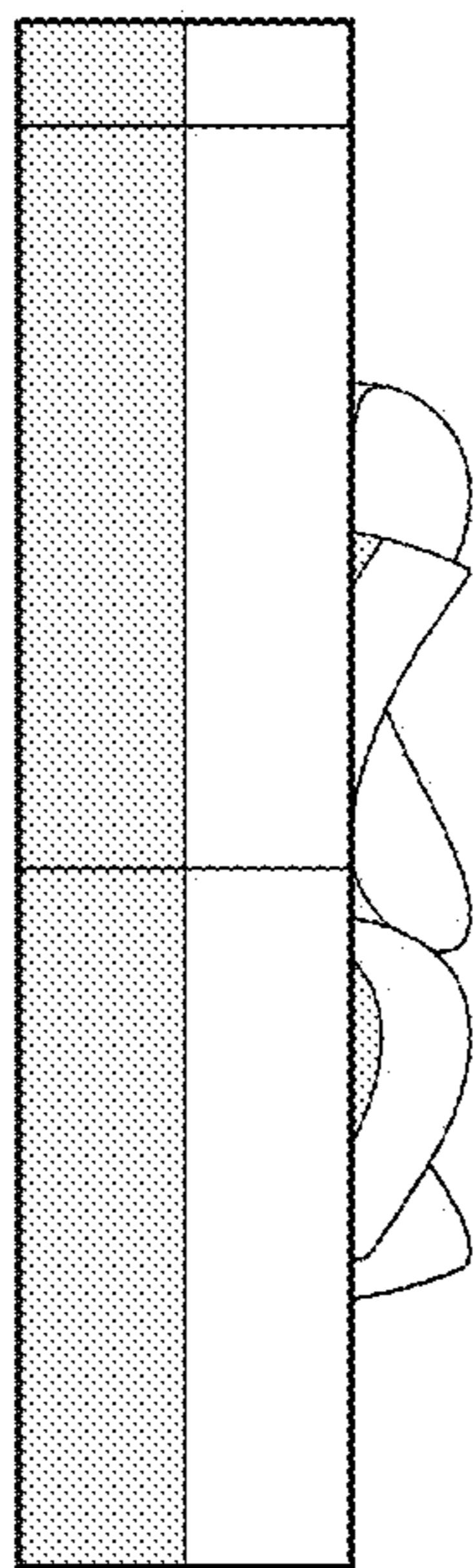

Fig. 53



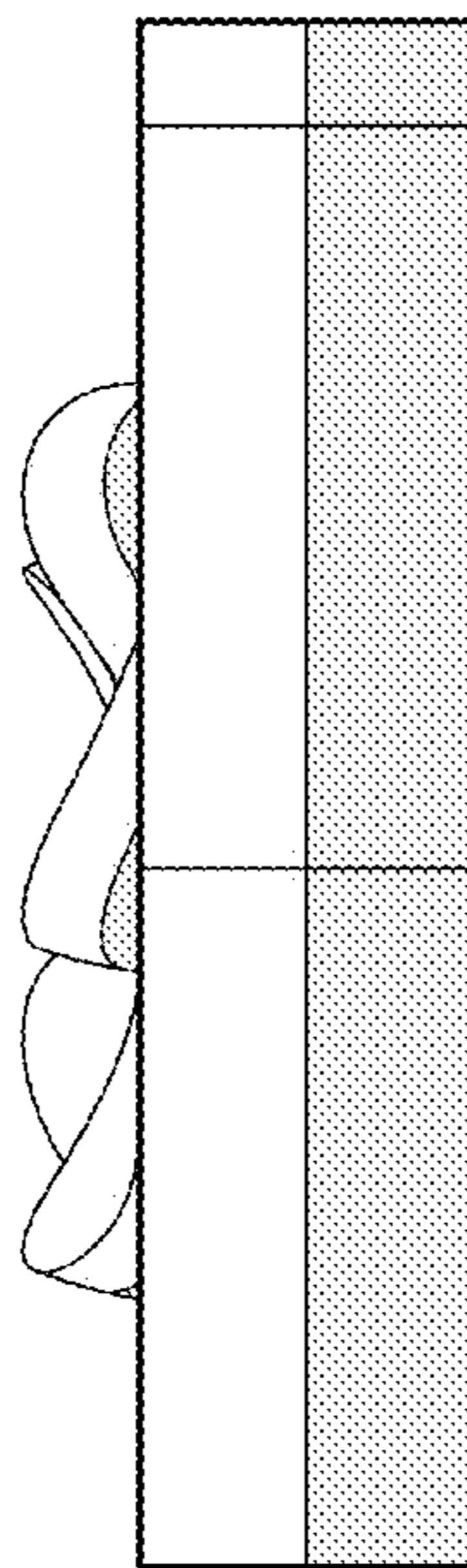

Fig. 54

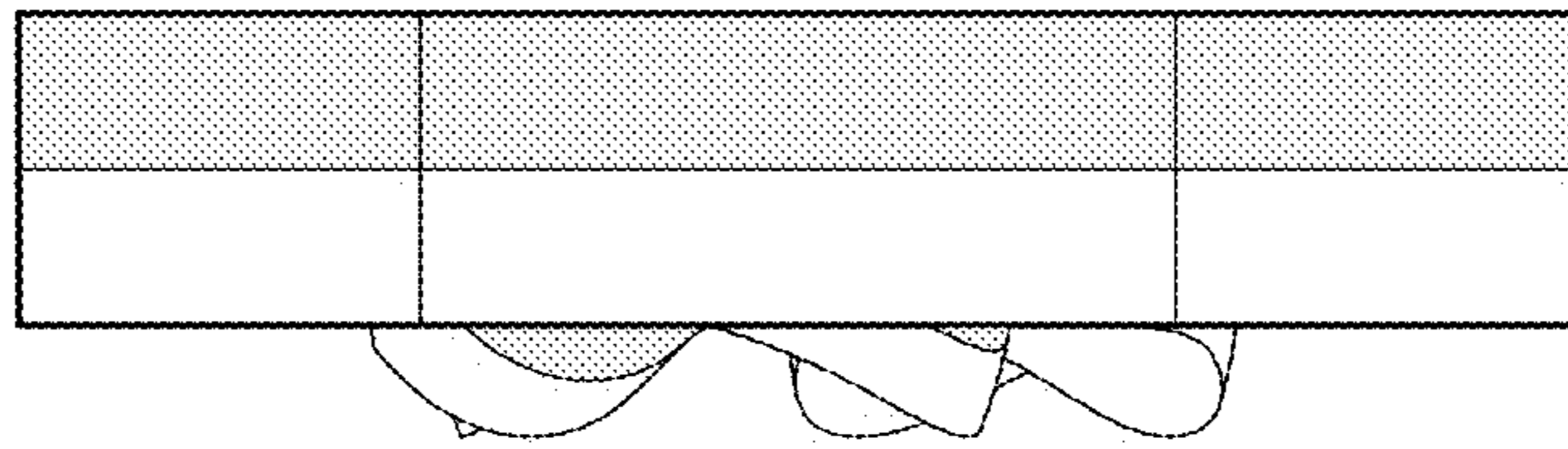

Fig. 55

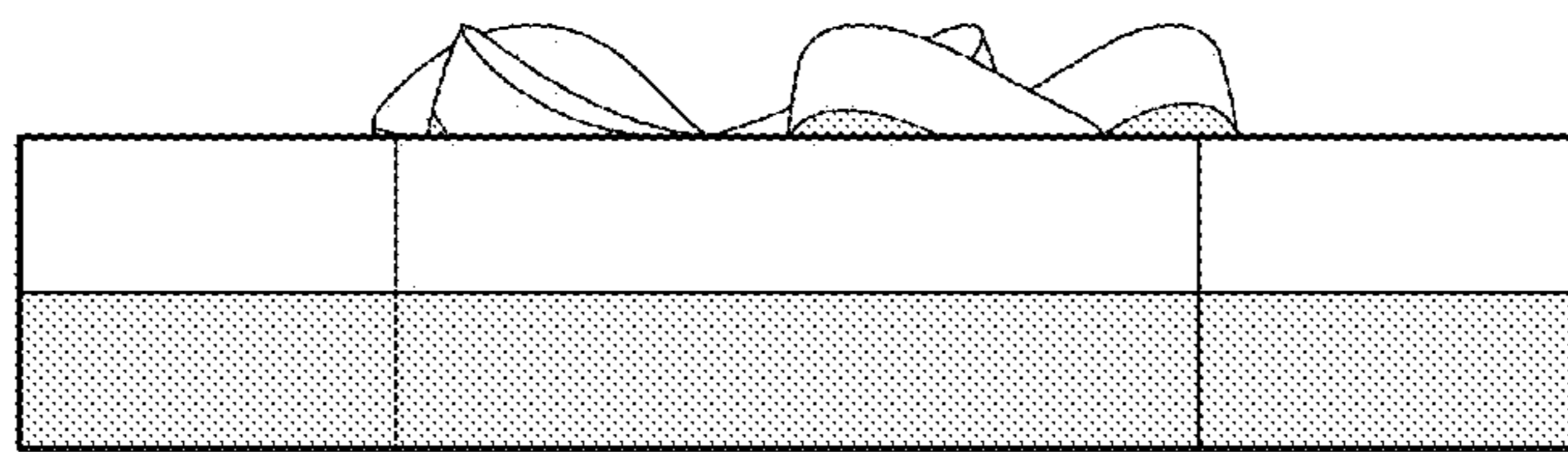

Fig. 56

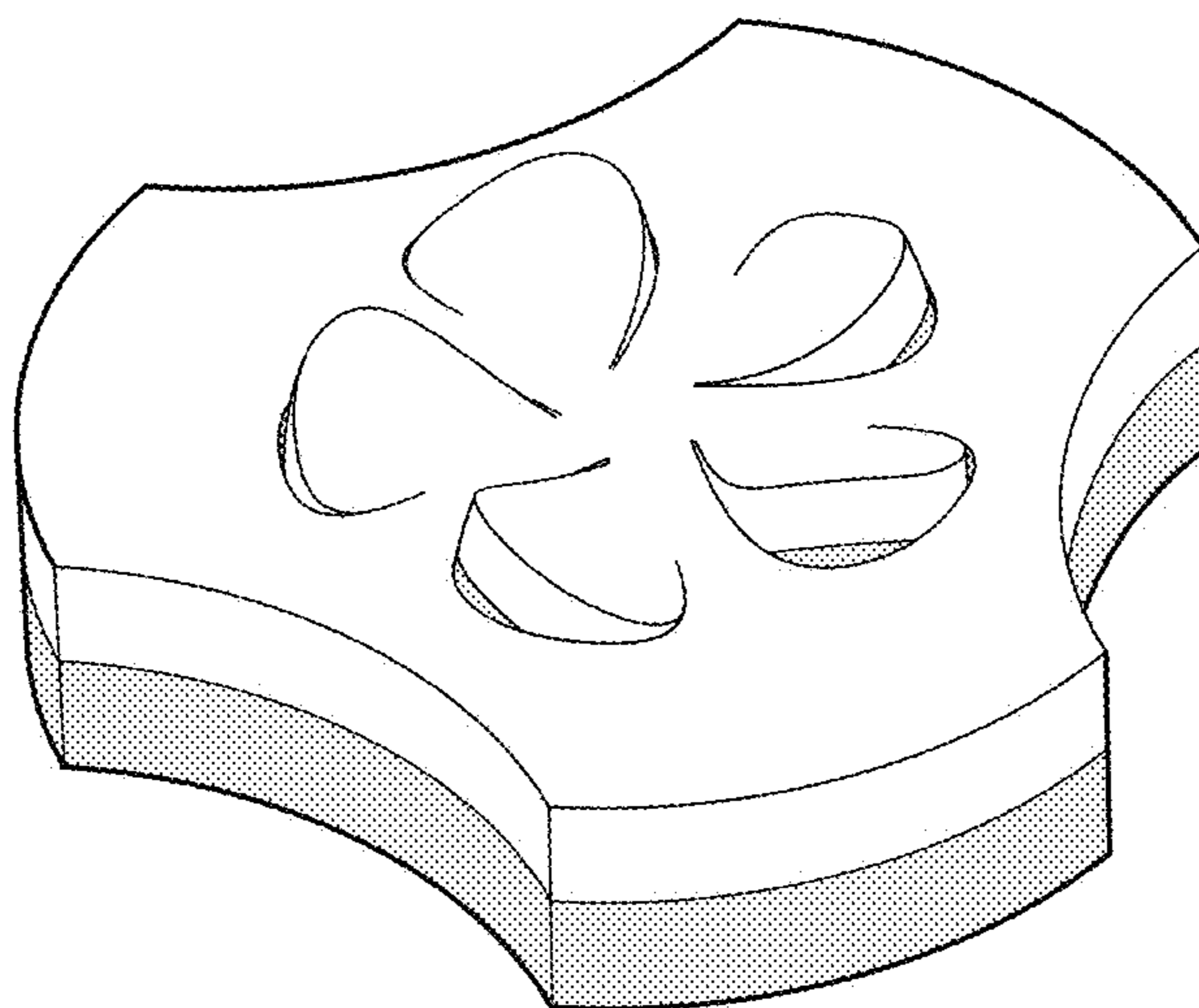

Fig. 57

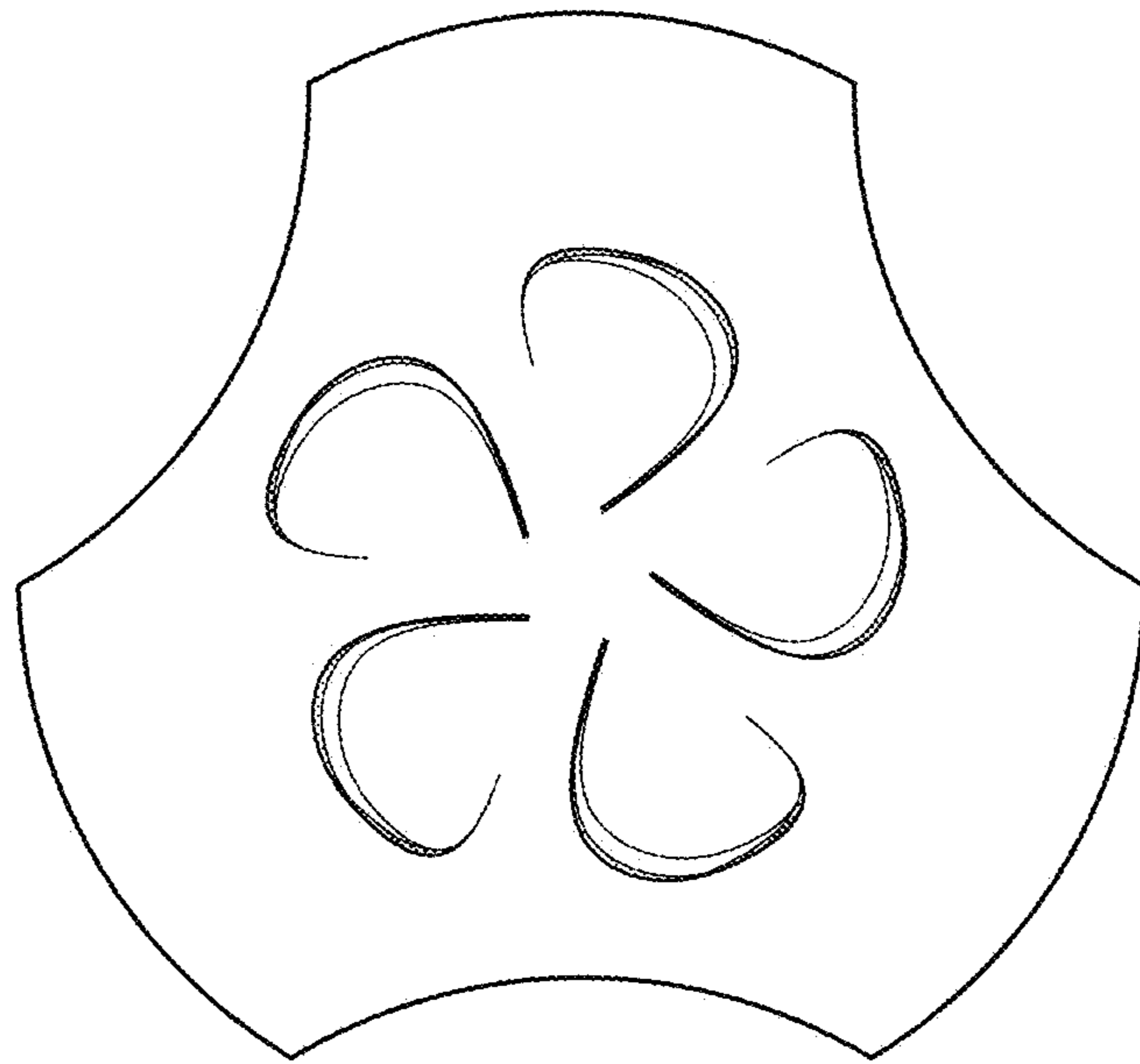

Fig. 58

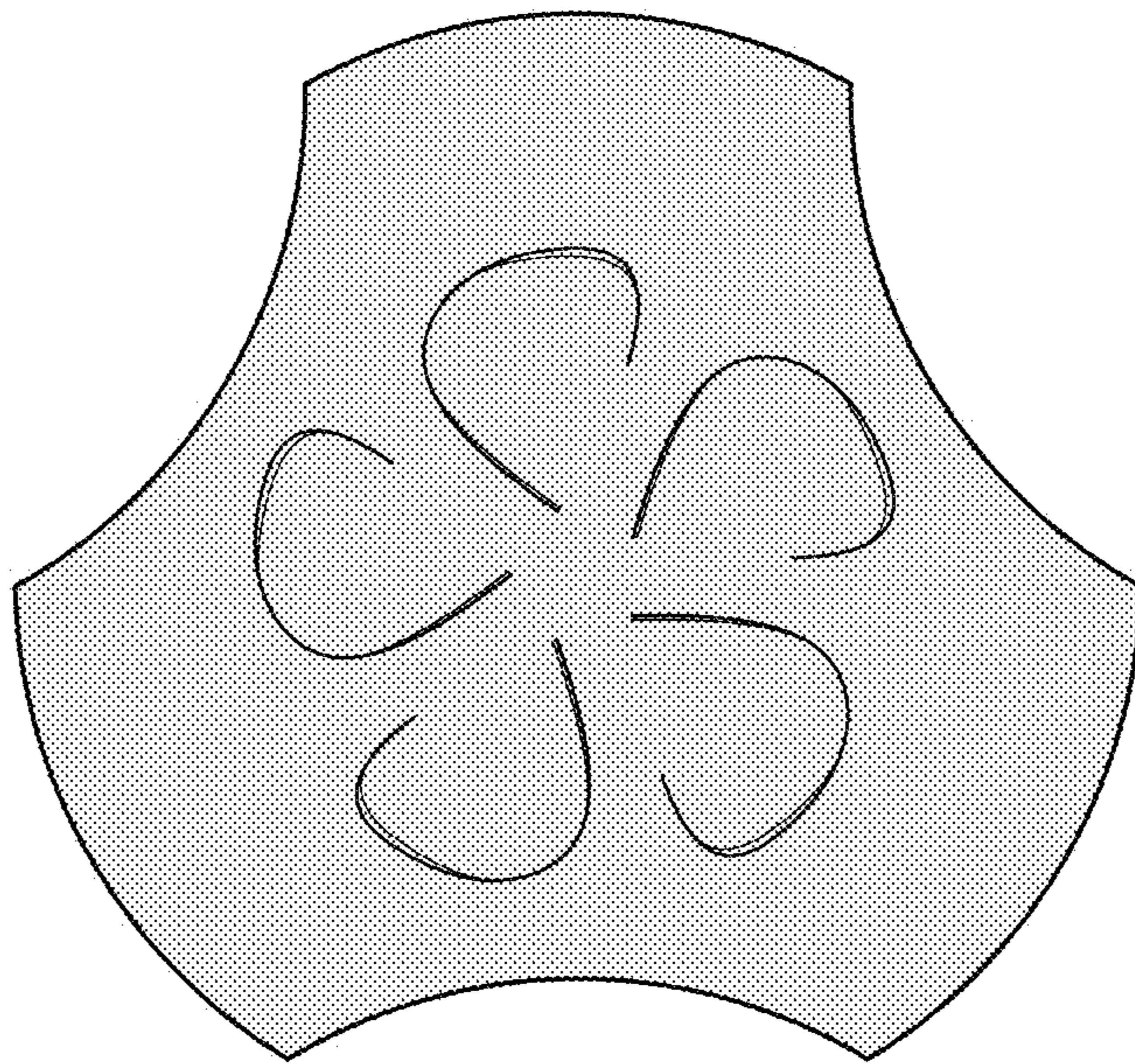

Fig. 59

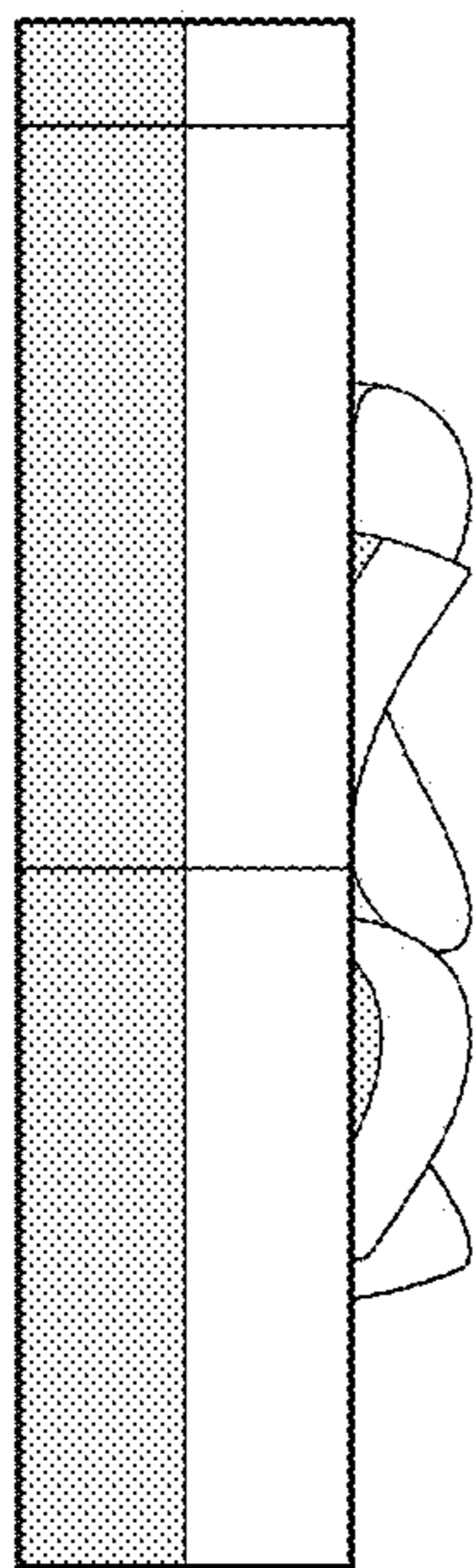

Fig. 60

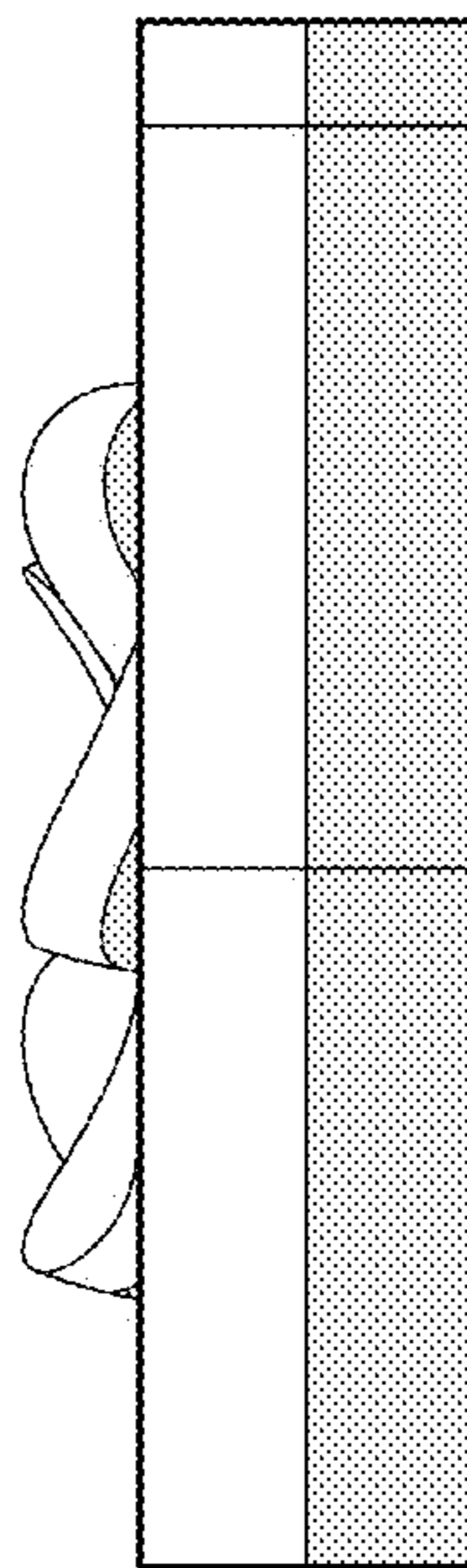

Fig. 61



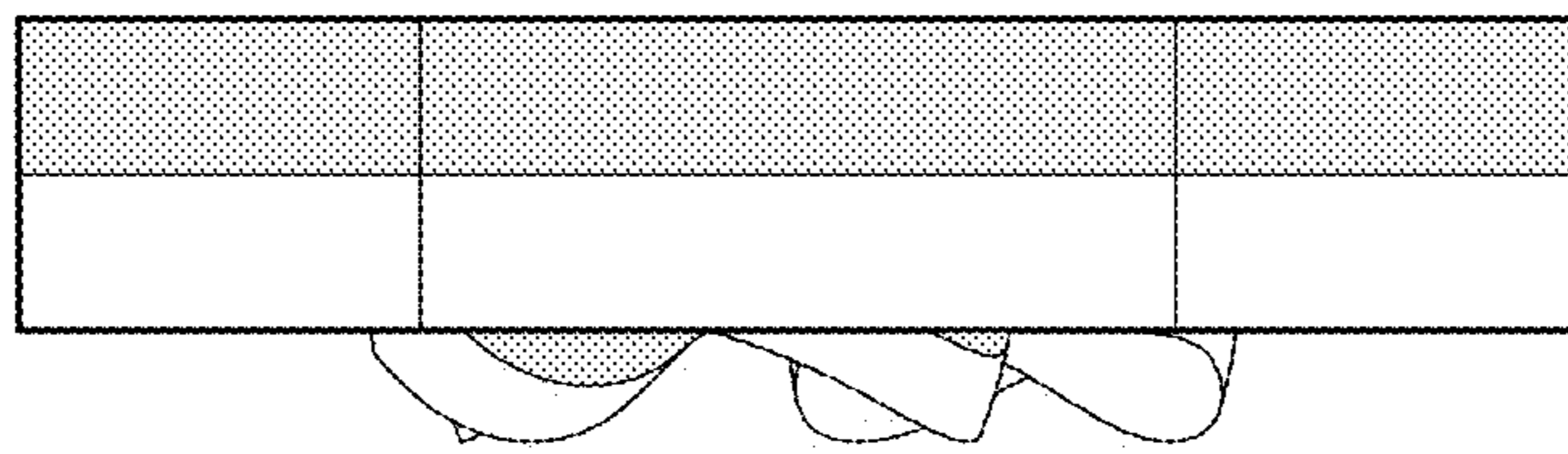

Fig. 62

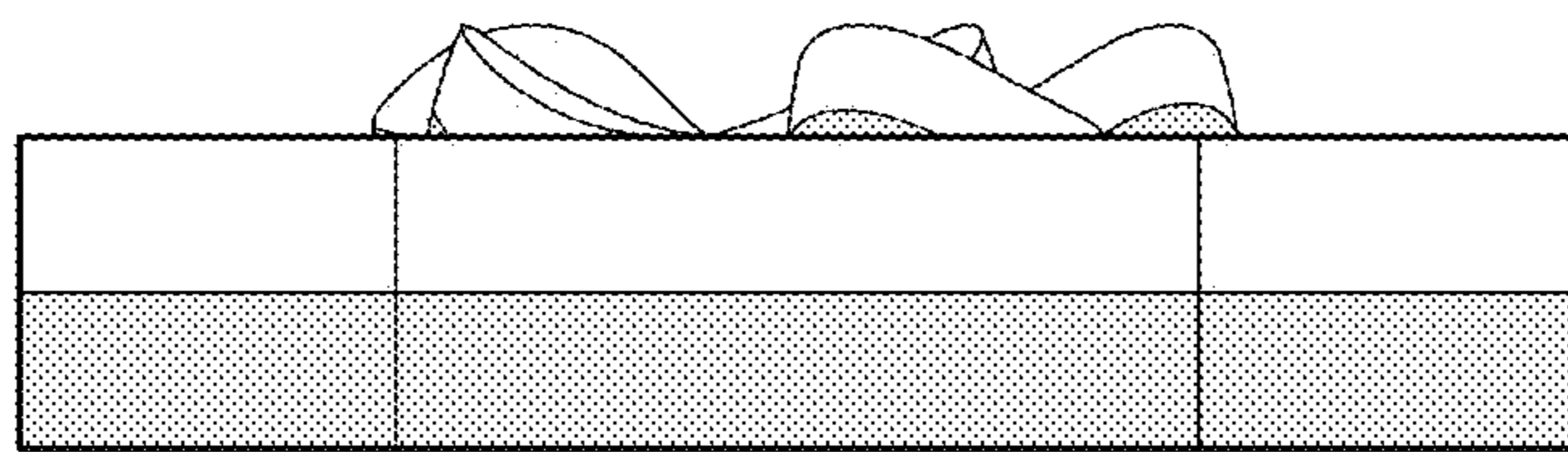

Fig. 63

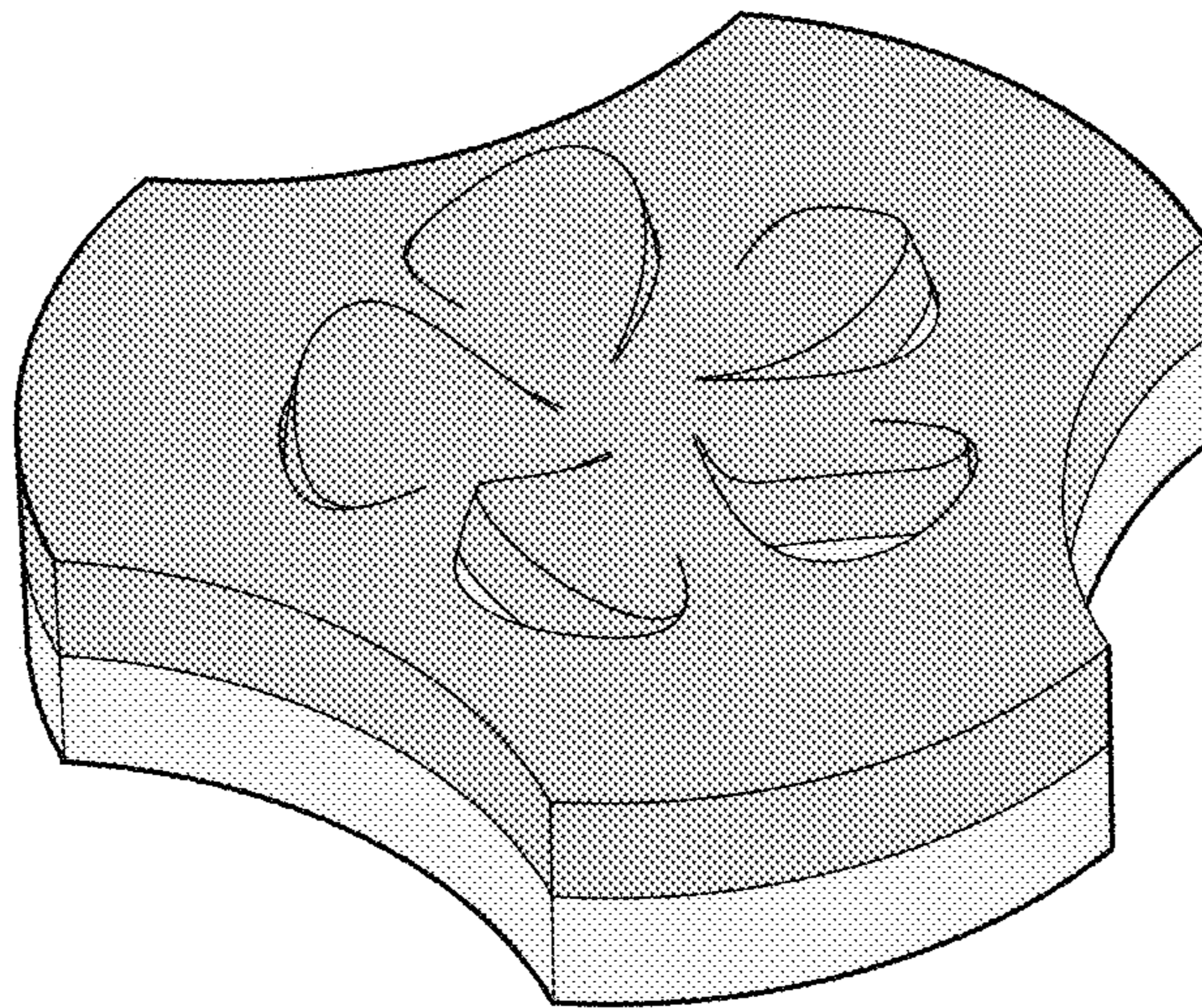

Fig. 64

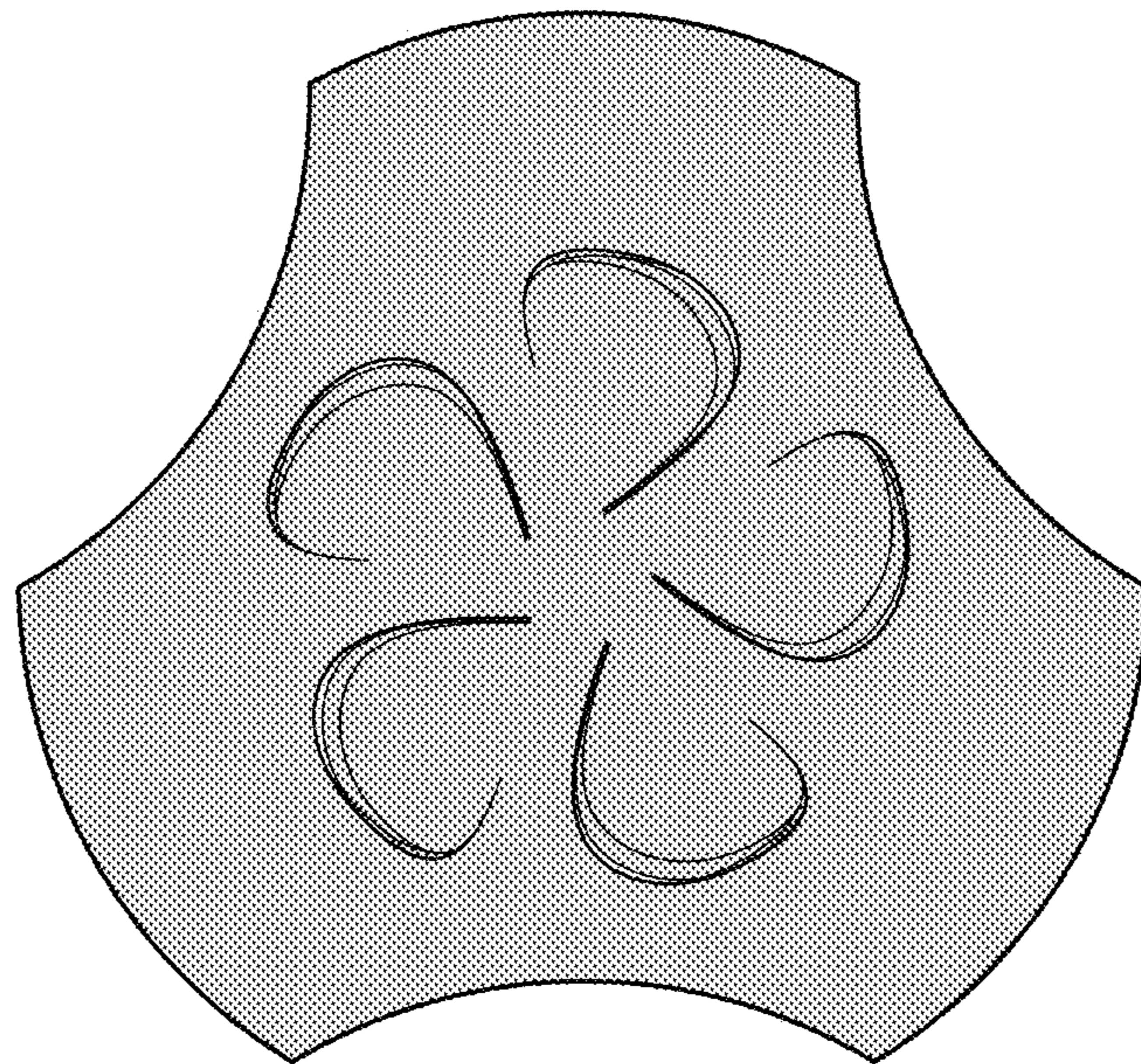

Fig. 65

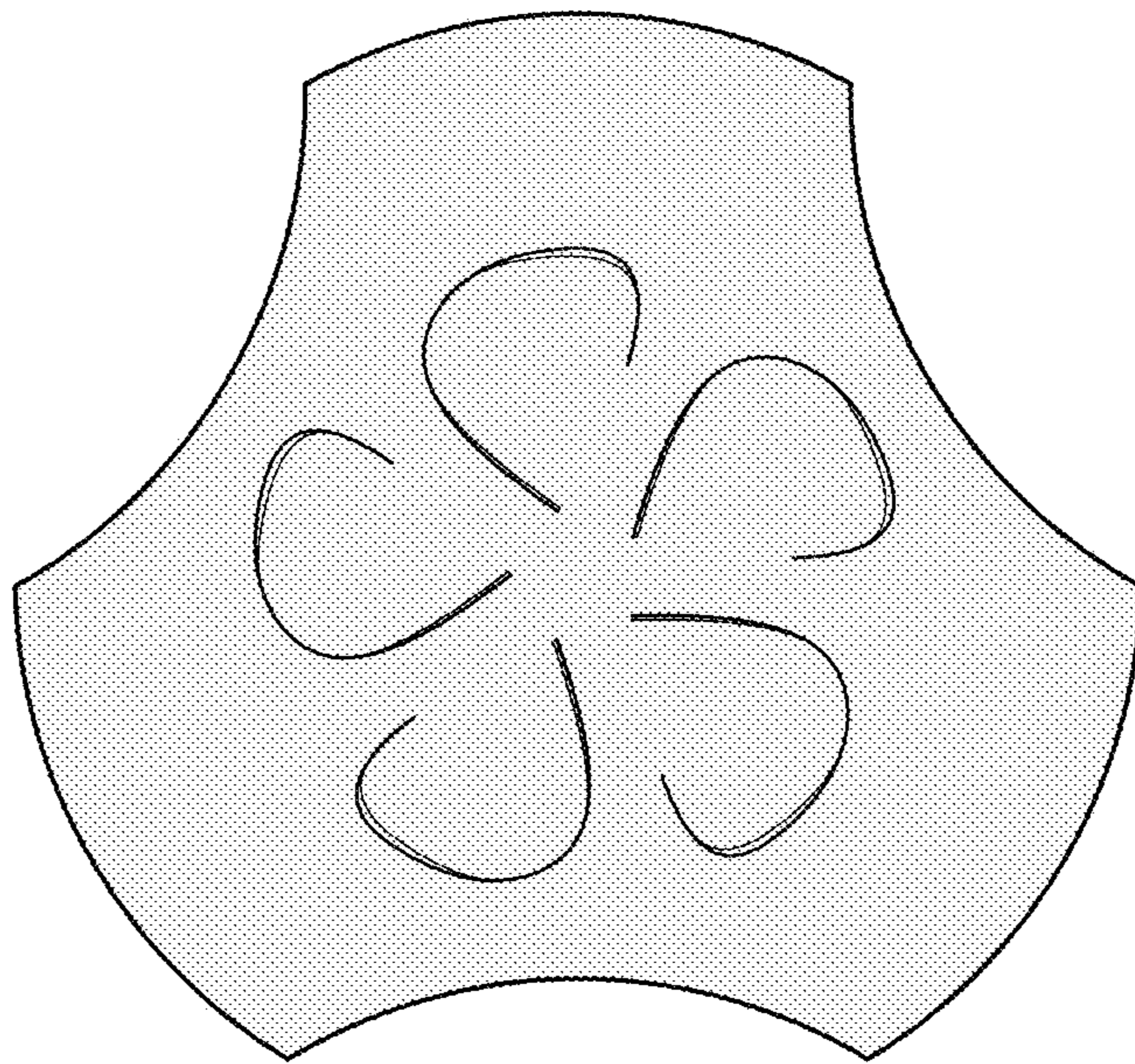

Fig. 66

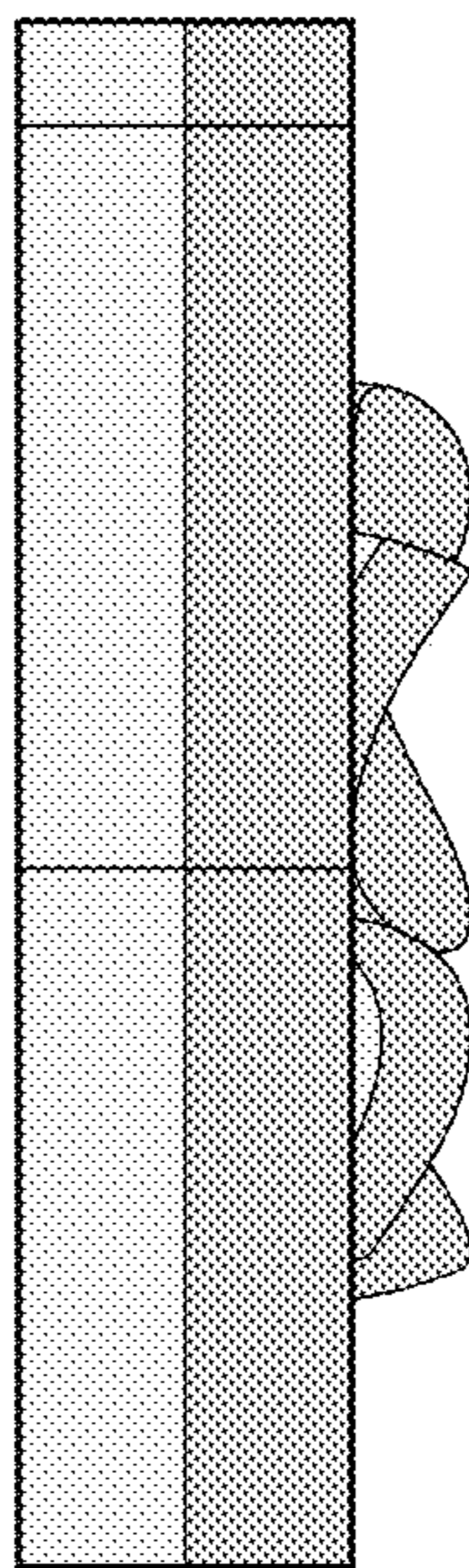

Fig. 67

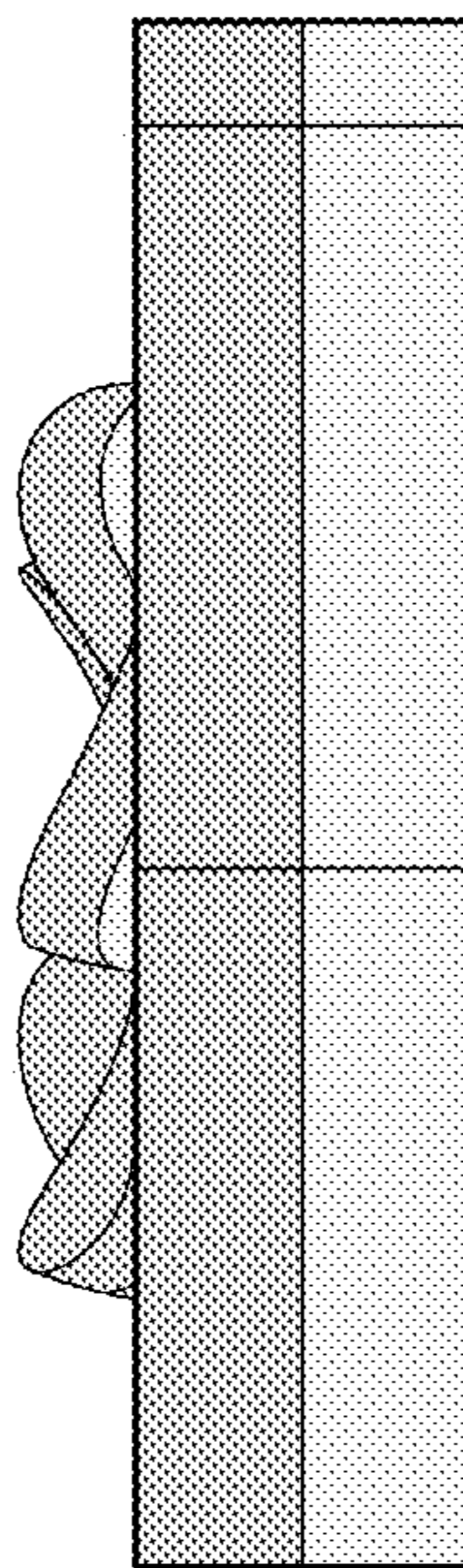

Fig. 68

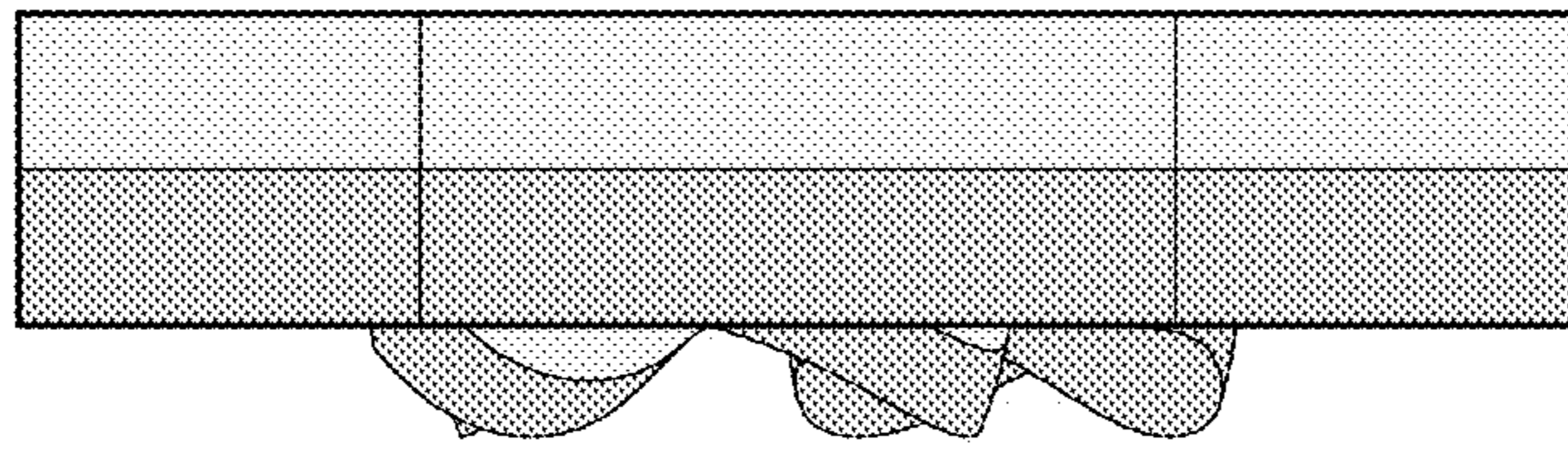

Fig. 69



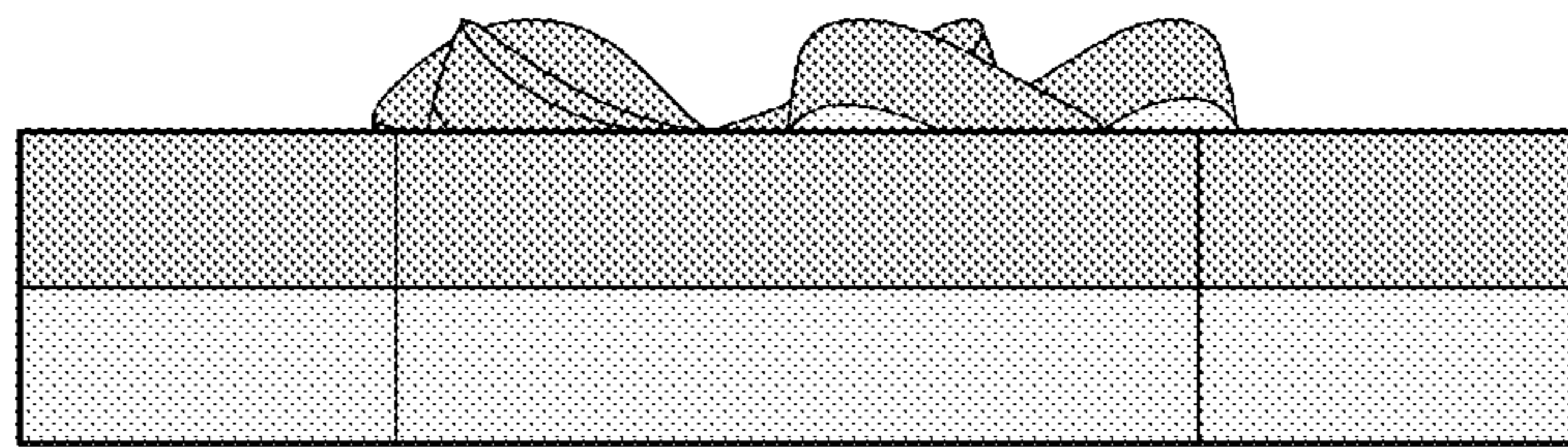

Fig. 70