



US00D980473S

(12) **United States Design Patent**  
**Jeong et al.**

(10) **Patent No.:** **US D980,473 S**

(45) **Date of Patent:** **\*\* Mar. 7, 2023**

(54) **DAYTIME RUNNING LIGHT FOR  
AUTOMOBILE**

(71) Applicants: **Hyundai Motor Company**, Seoul  
(KR); **Kia Corporation**, Seoul (KR)

(72) Inventors: **Da Young Jeong**, Gyeonggi-do (KR);  
**Byoung Suk Ahn**, Gyeonggi-do (KR);  
**Bradley Arnold**, Superior Township,  
MI (US)

(73) Assignees: **Hyundai Motor Company**, Seoul  
(KR); **Kia Corporation**, Seoul (KR)

(\*\*) Term: **15 Years**

(21) Appl. No.: **29/779,338**

(22) Filed: **Apr. 19, 2021**

(51) **LOC (14) Cl.** ..... **26-06**

(52) **U.S. Cl.**  
USPC ..... **D26/28**

(58) **Field of Classification Search**  
USPC ..... D26/28, 29, 30, 31, 32, 33, 34, 35, 36  
CPC ..... F21W 2103/35; F21W 2103/40; F21W  
2102/17; F21W 2102/30; F21W 2103/00;  
F21W 2103/55; F21W 2104/00; F21W  
2107/17; F21W 2107/13; F21S 41/00;  
F21S 41/141; F21S 41/162; F21S 41/18;  
F21S 41/20; F21S 41/33; F21S 41/36;  
F21S 41/60; F21S 43/00; F21V 21/04  
See application file for complete search history.

(56) **References Cited**

**U.S. PATENT DOCUMENTS**

D644,772 S \* 9/2011 Pfeiffer ..... D26/28  
D808,048 S \* 1/2018 Hannemann ..... D26/28

D816,248 S \* 4/2018 Antoniadis ..... D26/28  
D871,624 S \* 12/2019 Lin ..... D26/28  
D873,457 S \* 1/2020 Han ..... D26/28  
D877,369 S \* 3/2020 Thurber ..... D26/28  
D877,377 S \* 3/2020 Cheng ..... D26/28  
D887,041 S \* 6/2020 Lin ..... D26/28  
D900,360 S \* 10/2020 Lin ..... D26/28  
D919,136 S \* 5/2021 Park ..... D26/28  
D920,544 S \* 5/2021 Kim ..... D26/28  
D937,451 S \* 11/2021 Tovey ..... D26/28

\* cited by examiner

*Primary Examiner* — Angela J Lee

(74) *Attorney, Agent, or Firm* — Fox Rothschild LLP

(57) **CLAIM**

The ornamental design for a daytime running light for automobile, as shown and described.

**DESCRIPTION**

FIG. 1 is a perspective view of a daytime running light for automobile according to the present invention.  
FIG. 2 is a front view of the daytime running light for automobile of FIG. 1.  
FIG. 3 is a rear view of the daytime running light for automobile of FIG. 1.  
FIG. 4 is a left side view of the daytime running light for automobile of FIG. 1.  
FIG. 5 is a right side view of the daytime running light for automobile of FIG. 1.  
FIG. 6 is a top view of the daytime running light for automobile of FIG. 1; and,  
FIG. 7 is a bottom view of the daytime running light for automobile of FIG. 1.

**1 Claim, 7 Drawing Sheets**

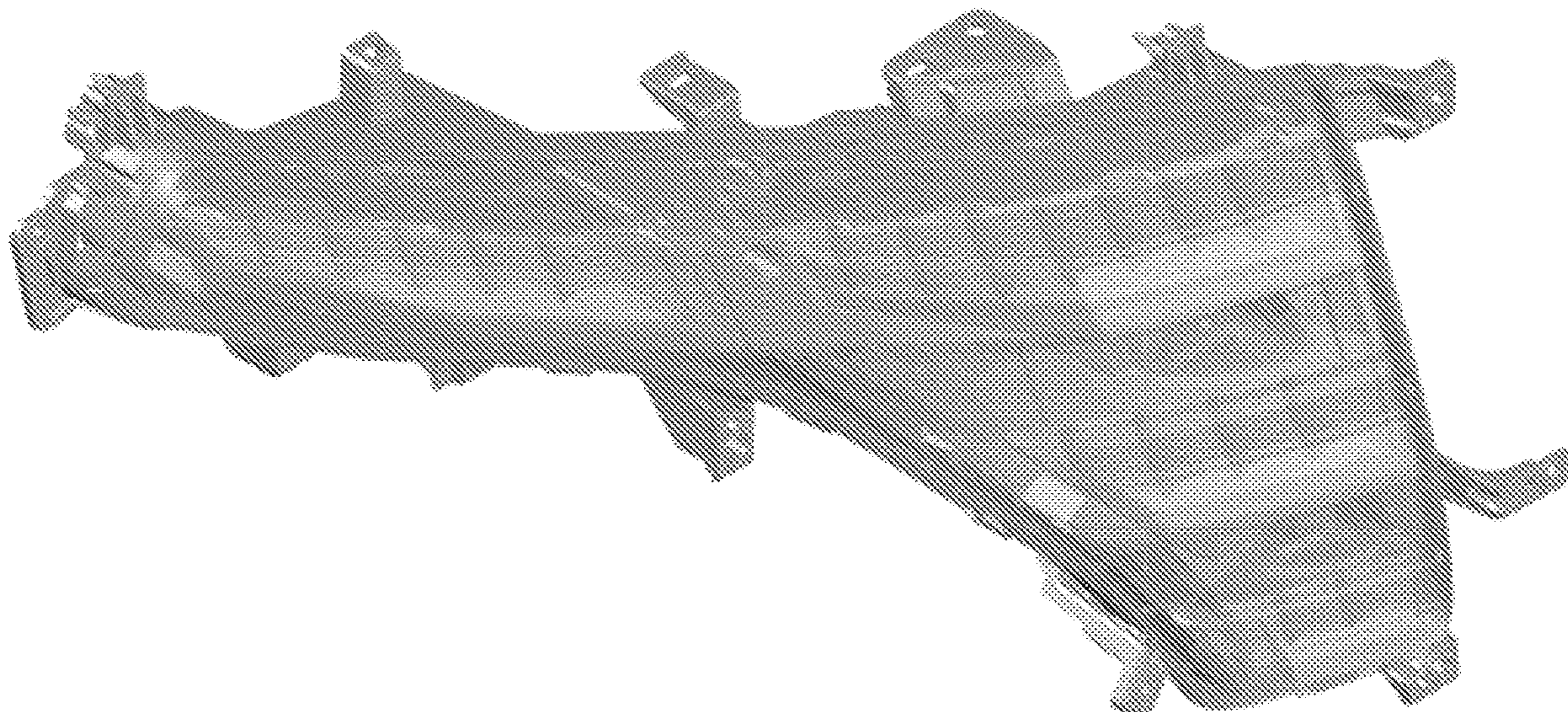

FIG. 1

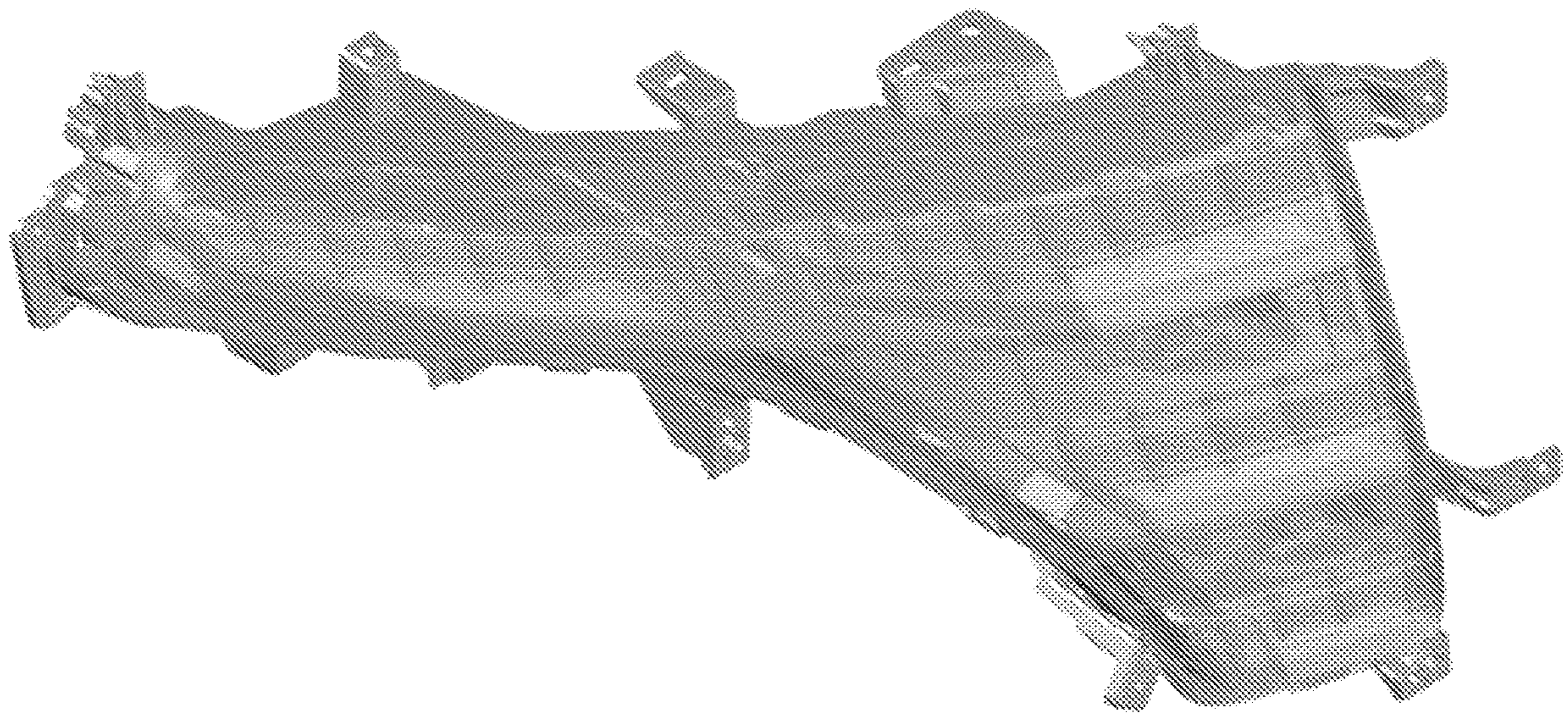

FIG. 2

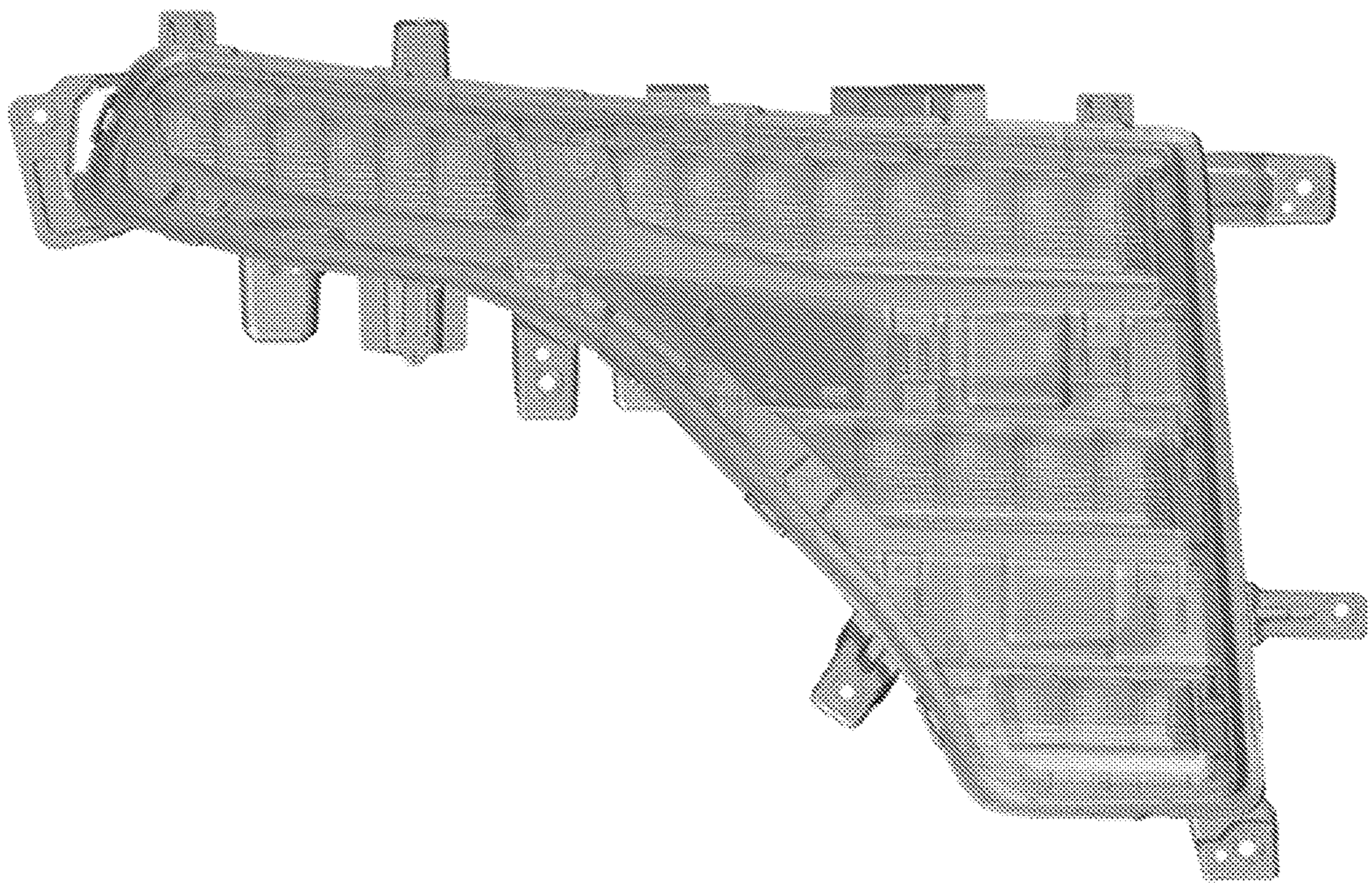

FIG. 3

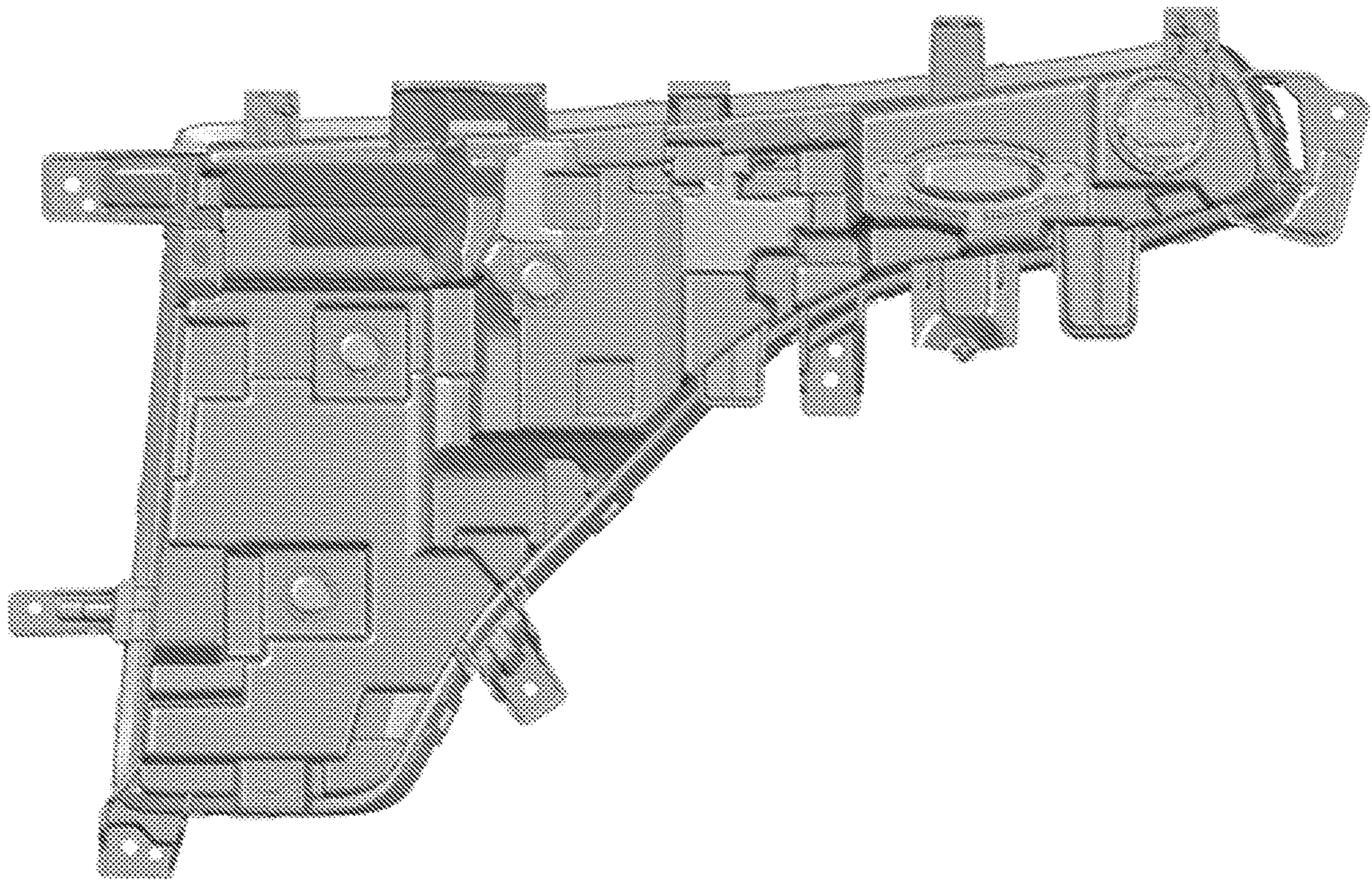

FIG. 4

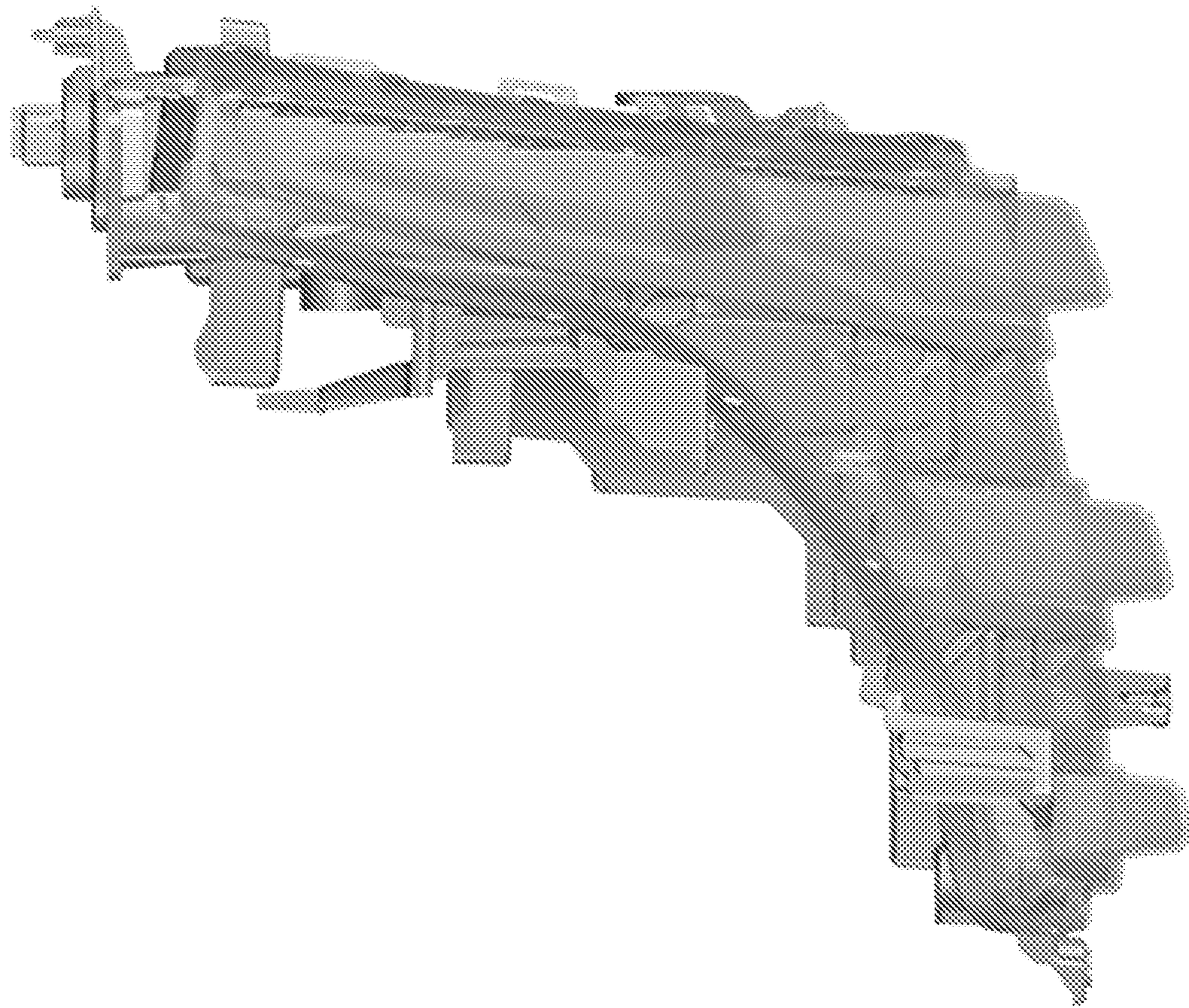

FIG. 5

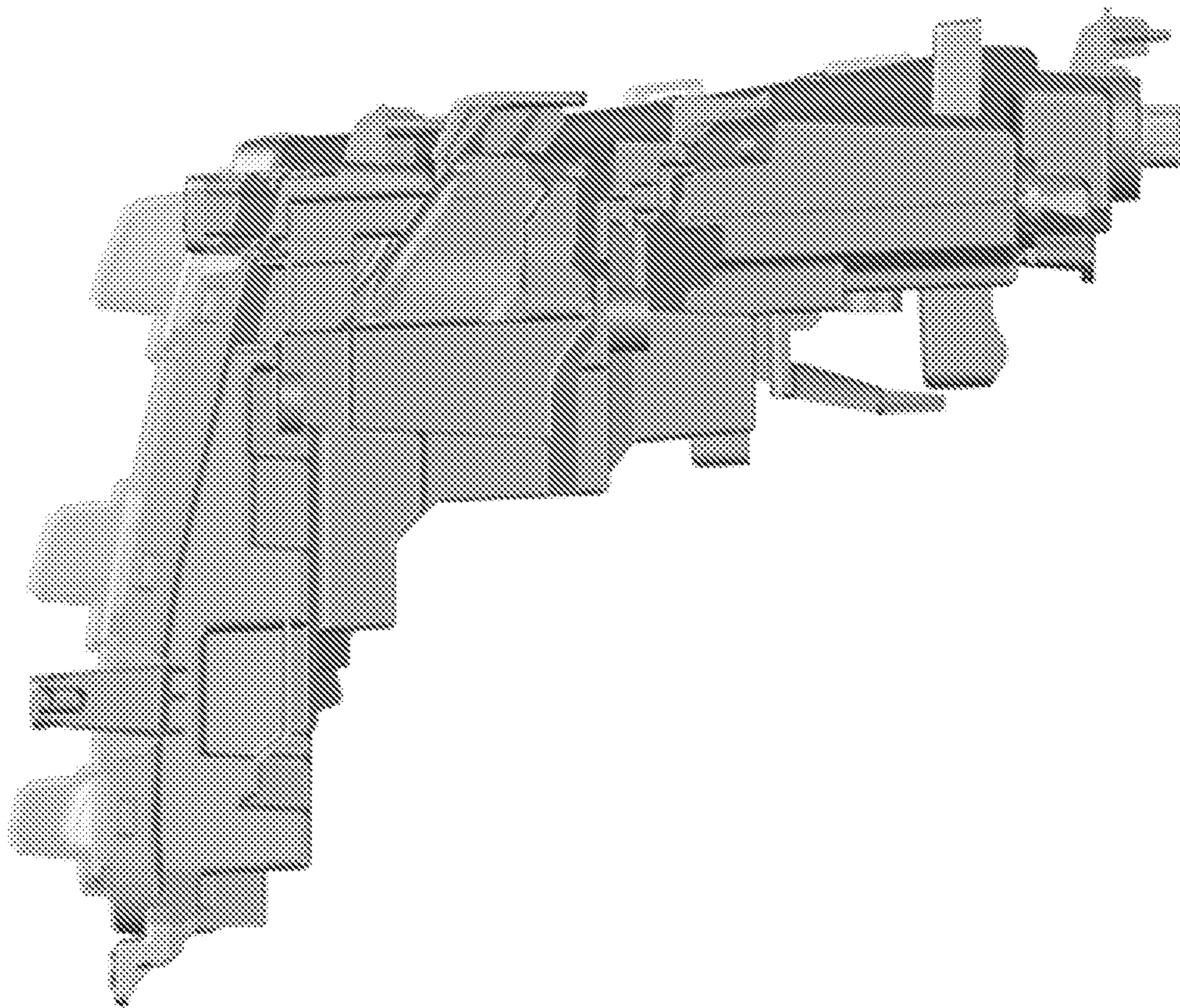

FIG. 6

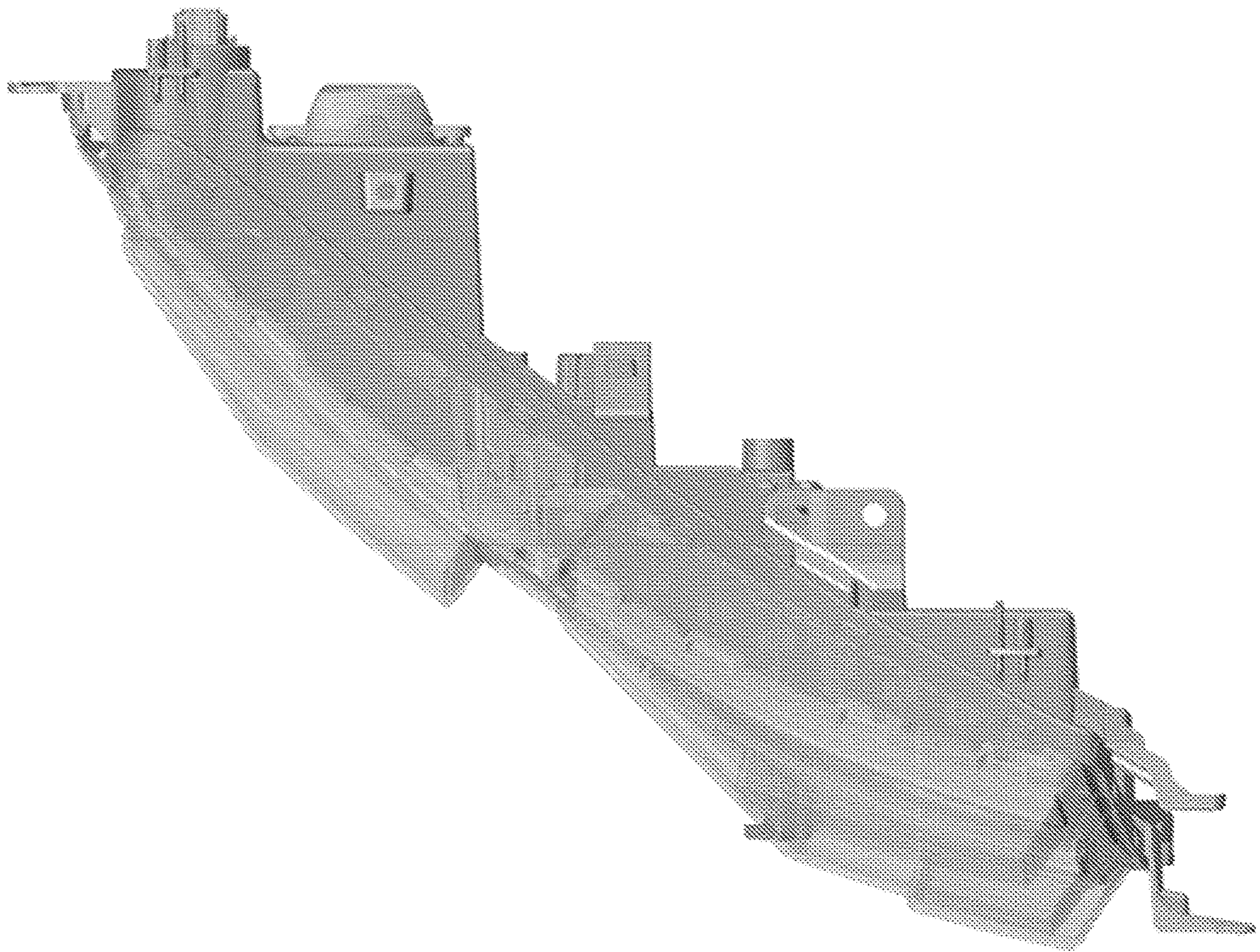

FIG. 7

