



US00D980399S

(12) **United States Design Patent**
Yang

(10) **Patent No.:** **US D980,399 S**
(45) **Date of Patent:** **** Mar. 7, 2023**

(54) **STERILIZER WITH A BRACKET**
(71) Applicant: **SHENZHEN ANTOP TECHNOLOGY CO., LTD**, Shenzhen (CN)
(72) Inventor: **Ruidian Yang**, Shenzhen (CN)
(73) Assignee: **SHENZHEN ANTOP TECHNOLOGY CO., LTD**, Shenzhen (CN)
(**) Term: **15 Years**

Available from internet, URL:<<https://www.amazon.ca/Towel-Warmer-Built-Mounted-Drying/dp/B085GJS9TV>> (Year: 2020).*

(Continued)

Primary Examiner — David G Muller
Assistant Examiner — Jamaal Rasheed
(74) *Attorney, Agent, or Firm* — Avek IP, LLC; Kent R. Erickson

(57) **CLAIM**

The ornamental design for a sterilizer with a bracket, as shown and described.

(21) Appl. No.: **29/763,382**
(22) Filed: **Dec. 22, 2020**
(30) **Foreign Application Priority Data**
Sep. 25, 2020 (CN) 202030577189.7
(51) **LOC (14) Cl.** **23-04**
(52) **U.S. Cl.**
USPC **D23/364**
(58) **Field of Classification Search**
USPC D23/332, 336, 351, 355–356, 359, D23/364–366, 378, 499
(Continued)

DESCRIPTION

FIG. 1 is a front perspective view of a sterilizer with a bracket of the present disclosure according to one embodiment;
FIG. 2 is a rear perspective view of the sterilizer with a bracket shown in FIG. 1;
FIG. 3 is a front elevational view of the sterilizer with a bracket shown in FIG. 1;
FIG. 4 is a rear elevational view of the sterilizer with a bracket shown in FIG. 1;
FIG. 5 is a left-side elevational view of the sterilizer with a bracket shown in FIG. 1;
FIG. 6 is a right-side elevational view of the sterilizer with a bracket shown in FIG. 1;
FIG. 7 is a top plan view of the sterilizer with a bracket shown in FIG. 1;
FIG. 8 is a bottom plan view of the sterilizer with a bracket shown in FIG. 1;
FIG. 9 is a front perspective view of a sterilizer with a bracket of the present disclosure according to another embodiment;
FIG. 10 is a rear perspective view of the sterilizer with a bracket shown in FIG. 9;
FIG. 11 is a front elevational view of the sterilizer with a bracket shown in FIG. 9;
FIG. 12 is a rear elevational view of the sterilizer with a bracket shown in FIG. 9;
FIG. 13 is a left-side elevational view of the sterilizer with a bracket shown in FIG. 9;

(Continued)

(56) **References Cited**
U.S. PATENT DOCUMENTS
11,071,803 B1 * 7/2021 Lan F21S 8/06
11,350,799 B2 * 6/2022 Yang A47K 10/48
(Continued)

FOREIGN PATENT DOCUMENTS
KR 300640627.0000 * 4/2012
KR 300846640.0000 * 3/2016

OTHER PUBLICATIONS
Towel Warmer with Built-in Timer and Wall Mounted Drying Rack, first available Apr. 4, 2020[online], [site visited Aug. 18, 2022].

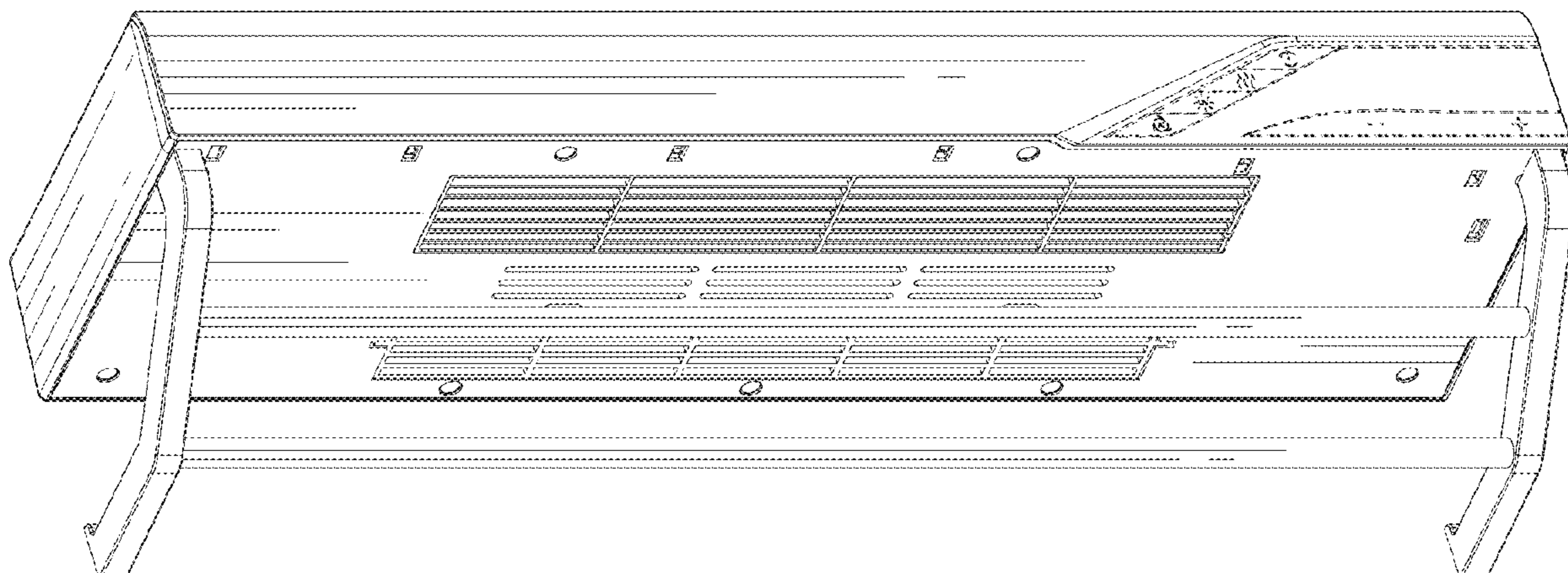

FIG. 14 is a right-side elevational view of the sterilizer with a bracket shown in FIG. 9;

FIG. 15 is a top plan view of the sterilizer with a bracket shown in FIG. 9; and,

FIG. 16 is a bottom plan view of the sterilizer with a bracket shown in FIG. 9.

The broken lines shown in the drawings are for the purpose of illustrating portions of the sterilizer with a bracket that form no part of the claimed design.

1 Claim, 16 Drawing Sheets

(58) **Field of Classification Search**

CPC F24F 1/029; F24F 1/035; F24F 1/0287;
F24F 6/06; F24F 6/14; F24F 13/06; F24F
13/20; F24F 13/222; F24F 3/16; F24F
3/1405

See application file for complete search history.

(56)

References Cited

U.S. PATENT DOCUMENTS

2020/0200366	A1 *	6/2020	Goza	F21V 15/01
2022/0095853	A1 *	3/2022	Yang	A47K 10/06
2022/0095854	A1 *	3/2022	Yang	A47K 10/06
2022/0095855	A1 *	3/2022	Yang	A47K 10/06
2022/0096672	A1 *	3/2022	Yang	A47K 10/06
2022/0096673	A1 *	3/2022	Yang	D06F 58/203

OTHER PUBLICATIONS

YooEca New Style Touch Screen Smart UV Towel Dryer Rack, first available Mar. 1, 2019[online], [site visited Aug. 23, 2022]. Available from internet, URL:<<https://expo.tuya.com/product/882020>> (Year: 2019).*

* cited by examiner

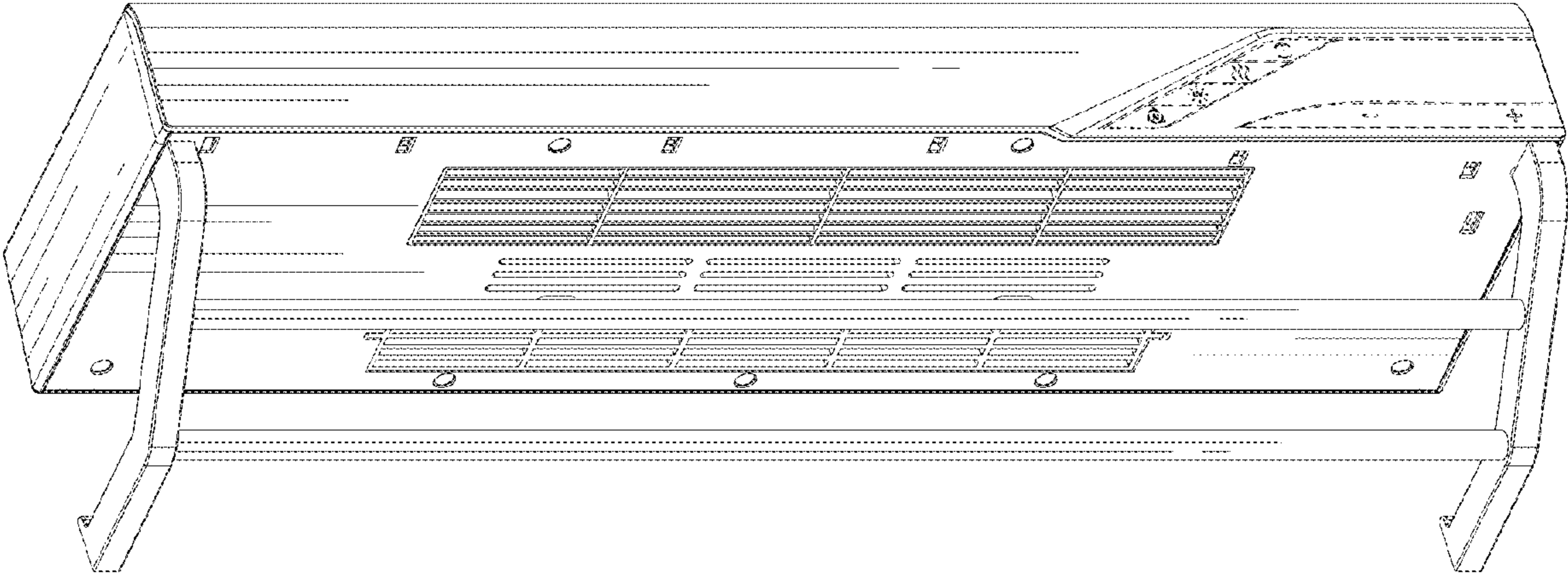

FIG.1

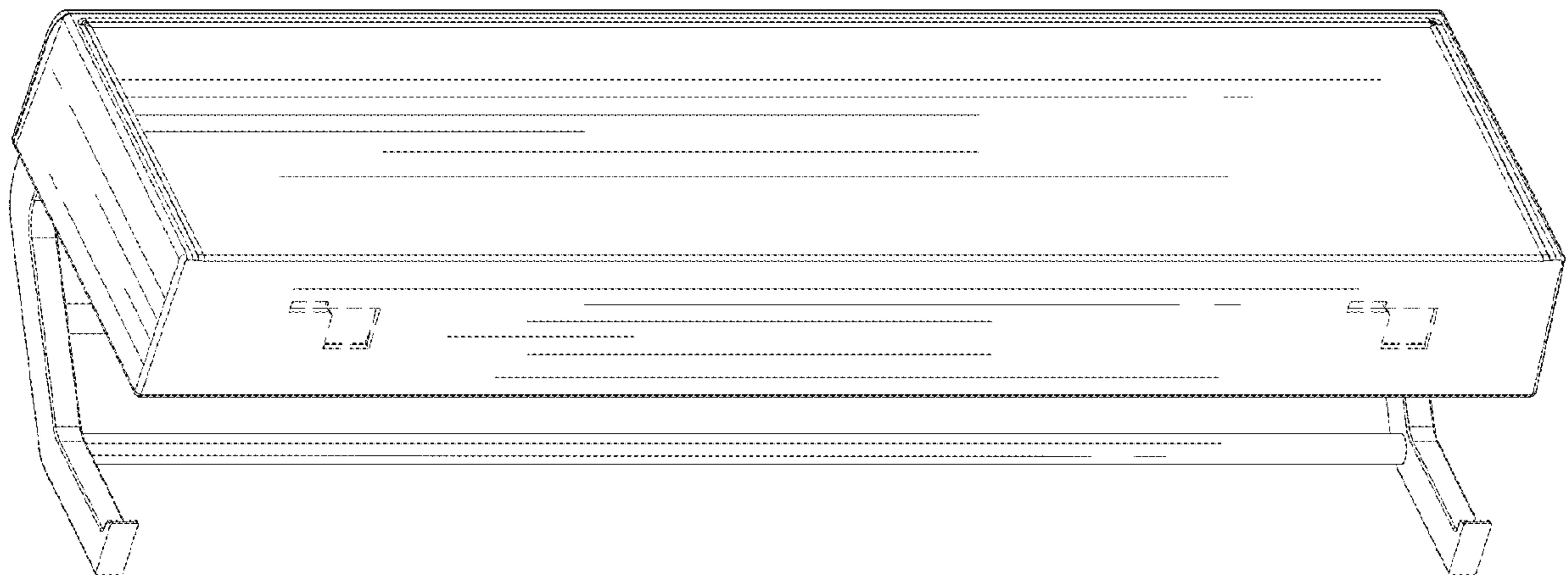

FIG.2

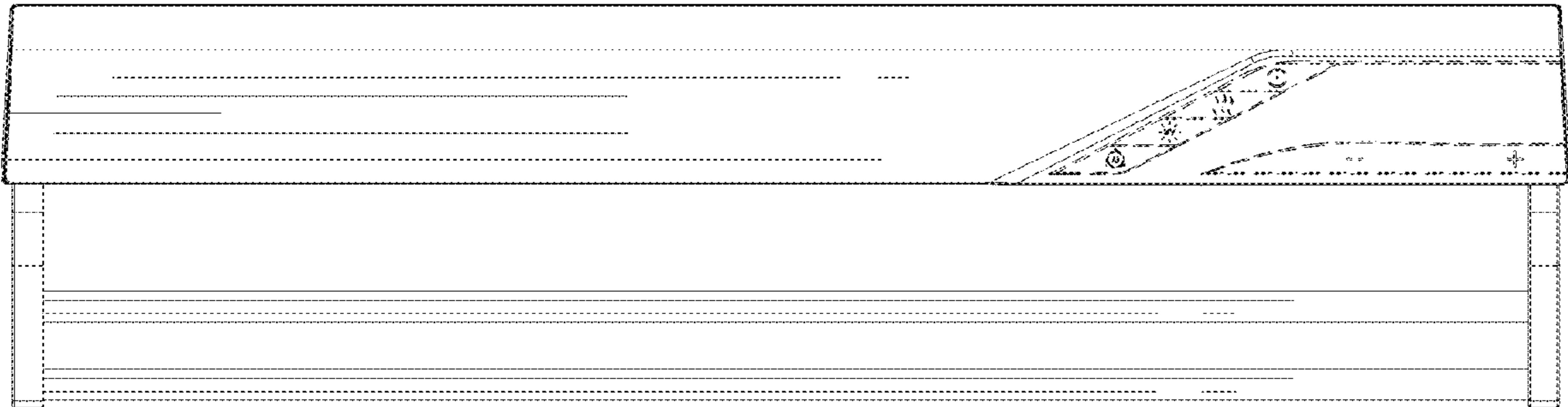

FIG.3

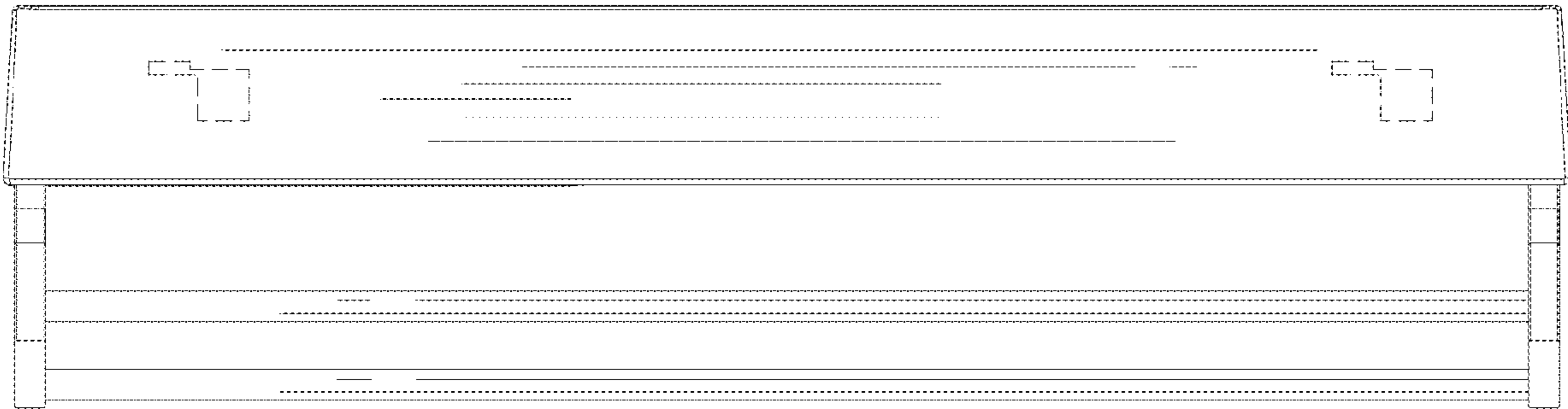

FIG.4

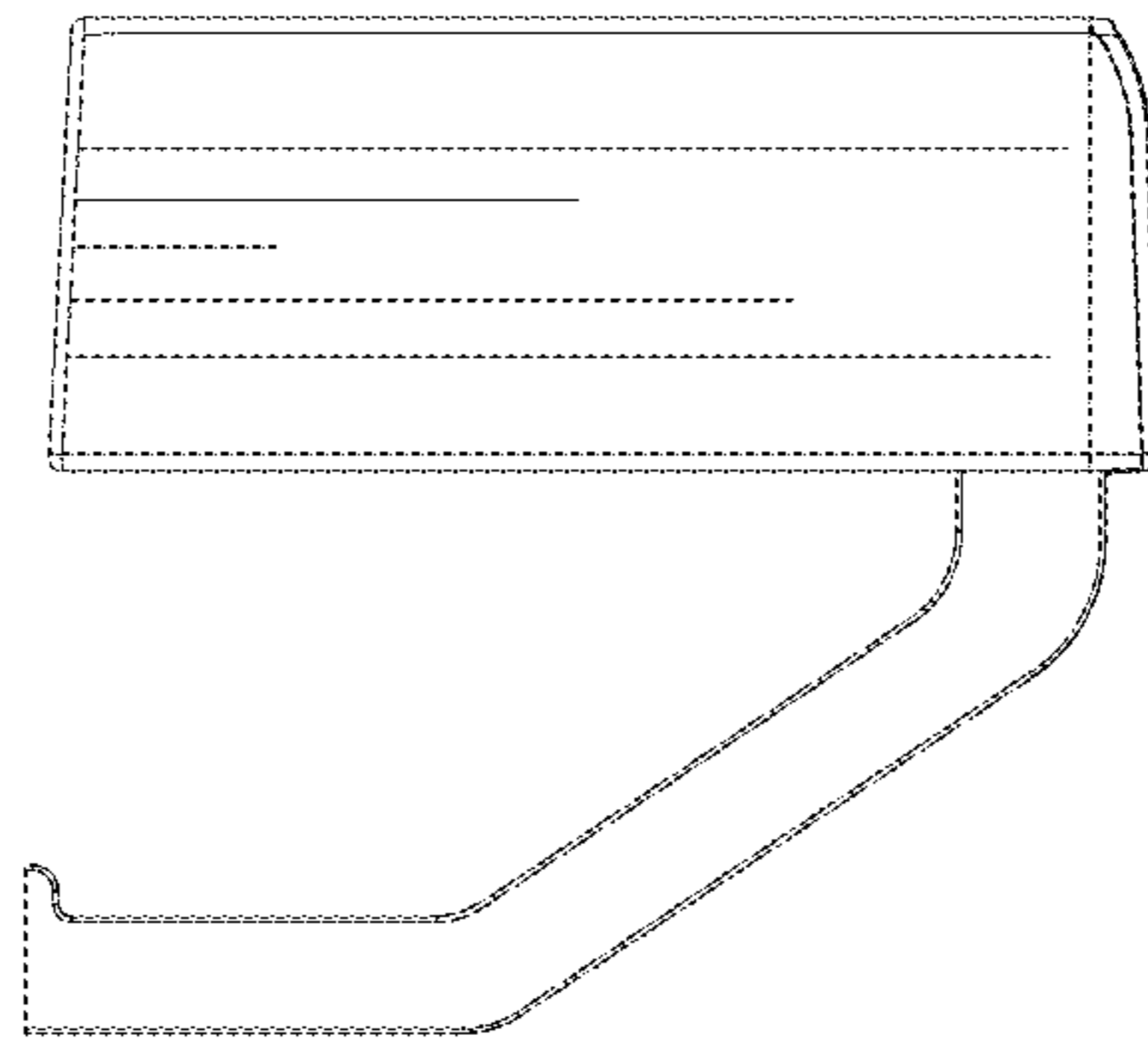

FIG. 5

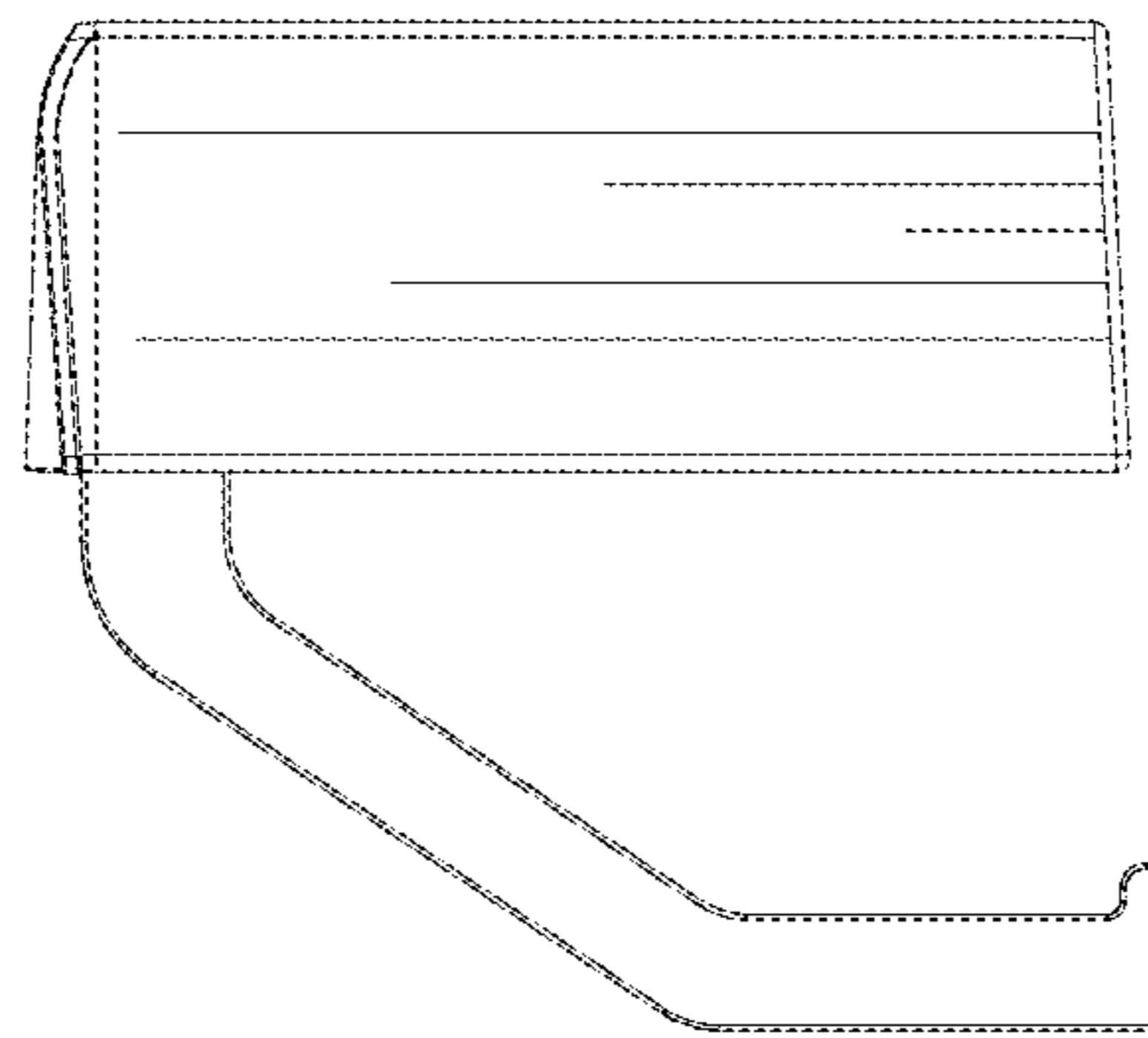

FIG.6

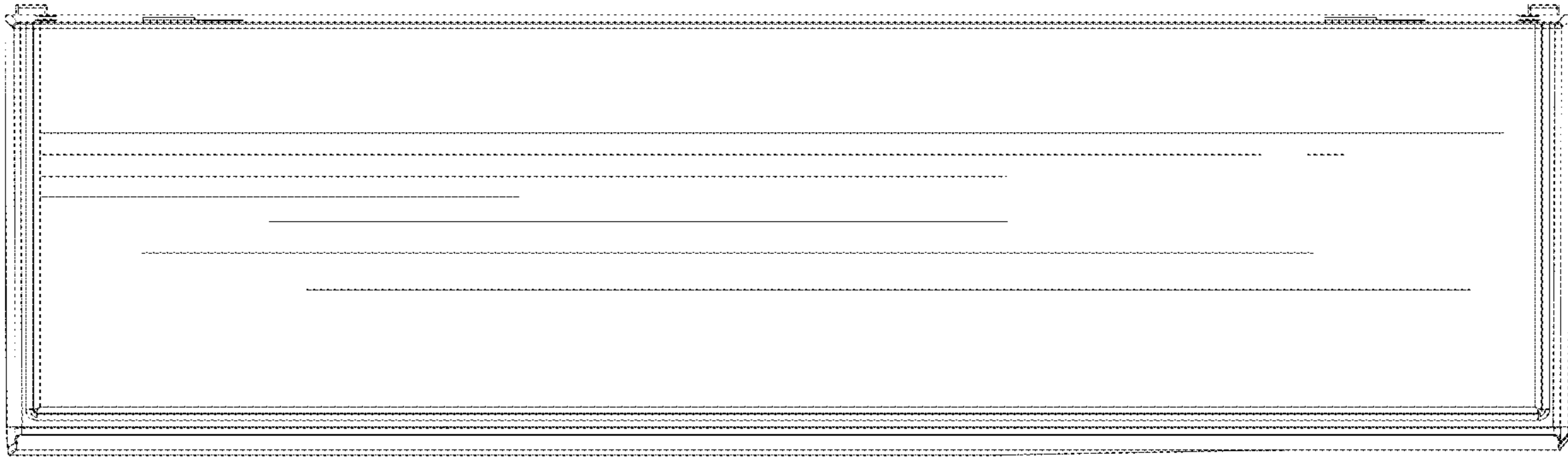

FIG.7

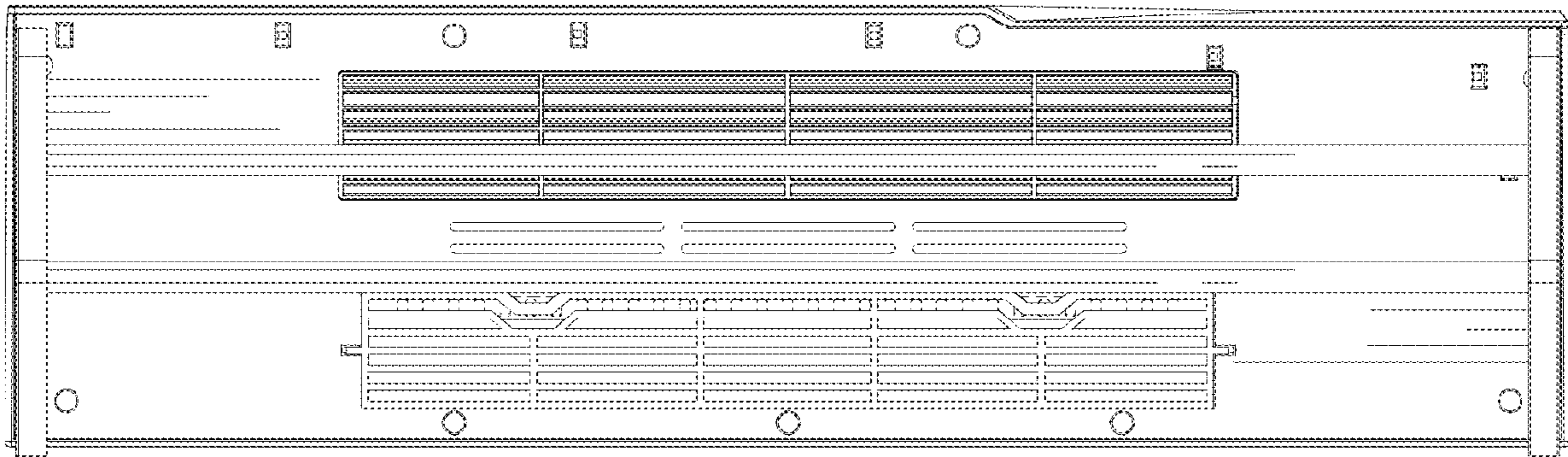

FIG.8

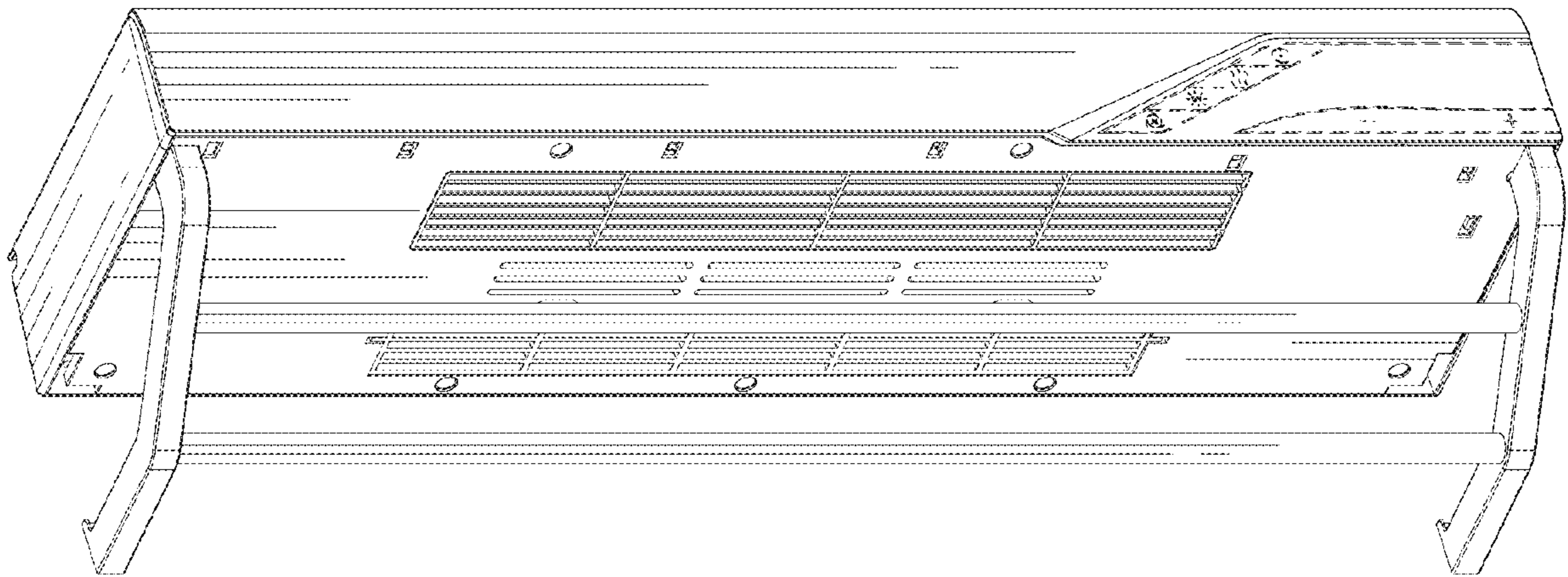

FIG. 9

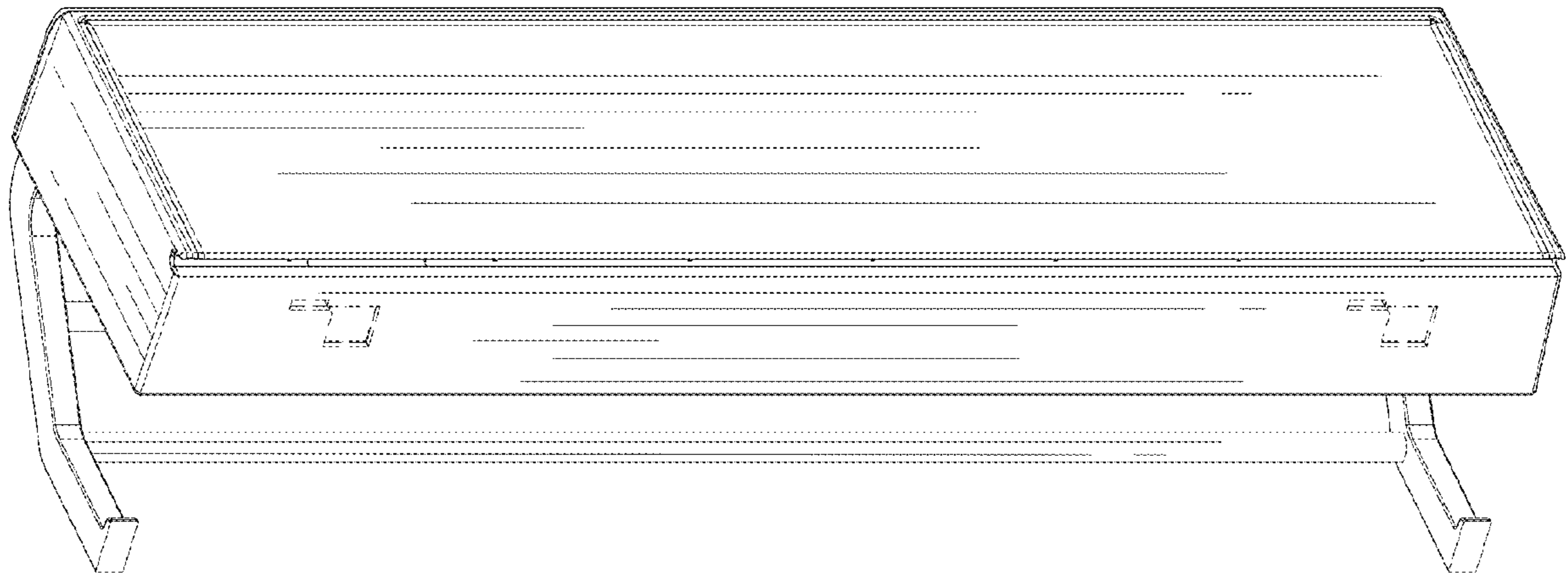

FIG. 10

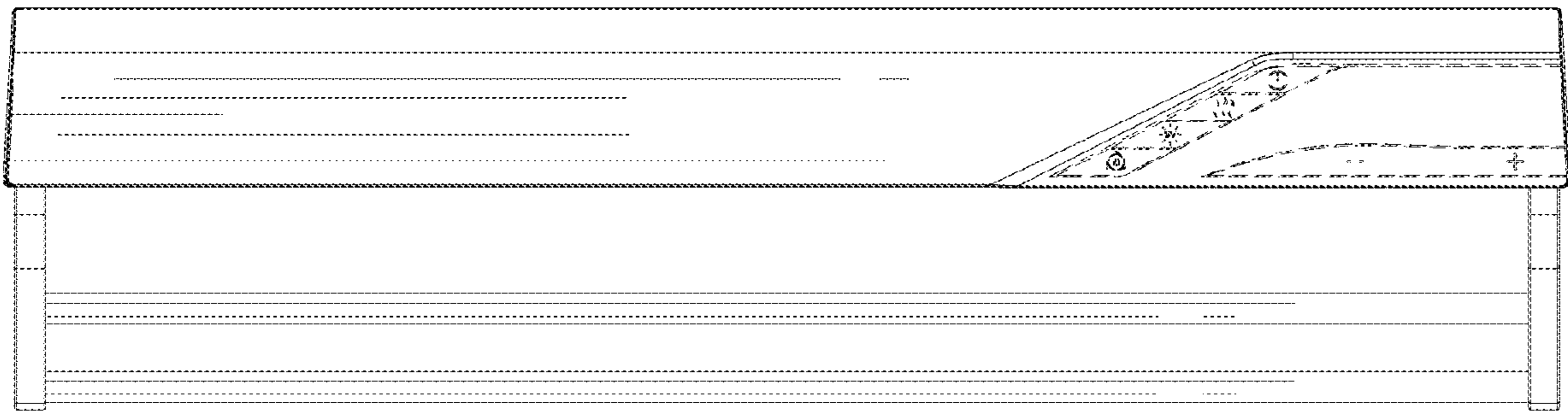

FIG. 11

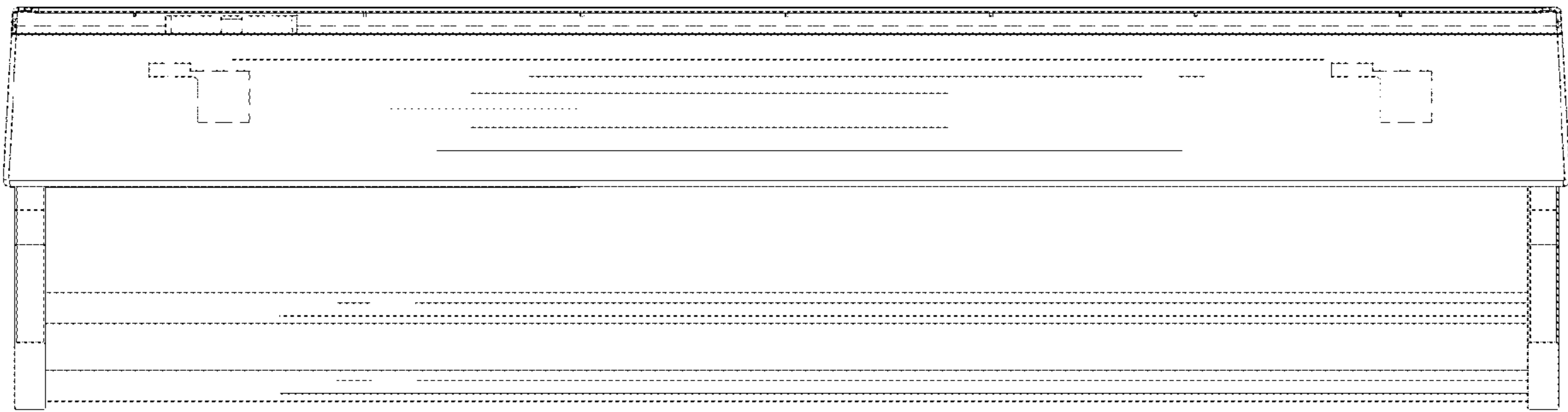

FIG. 12

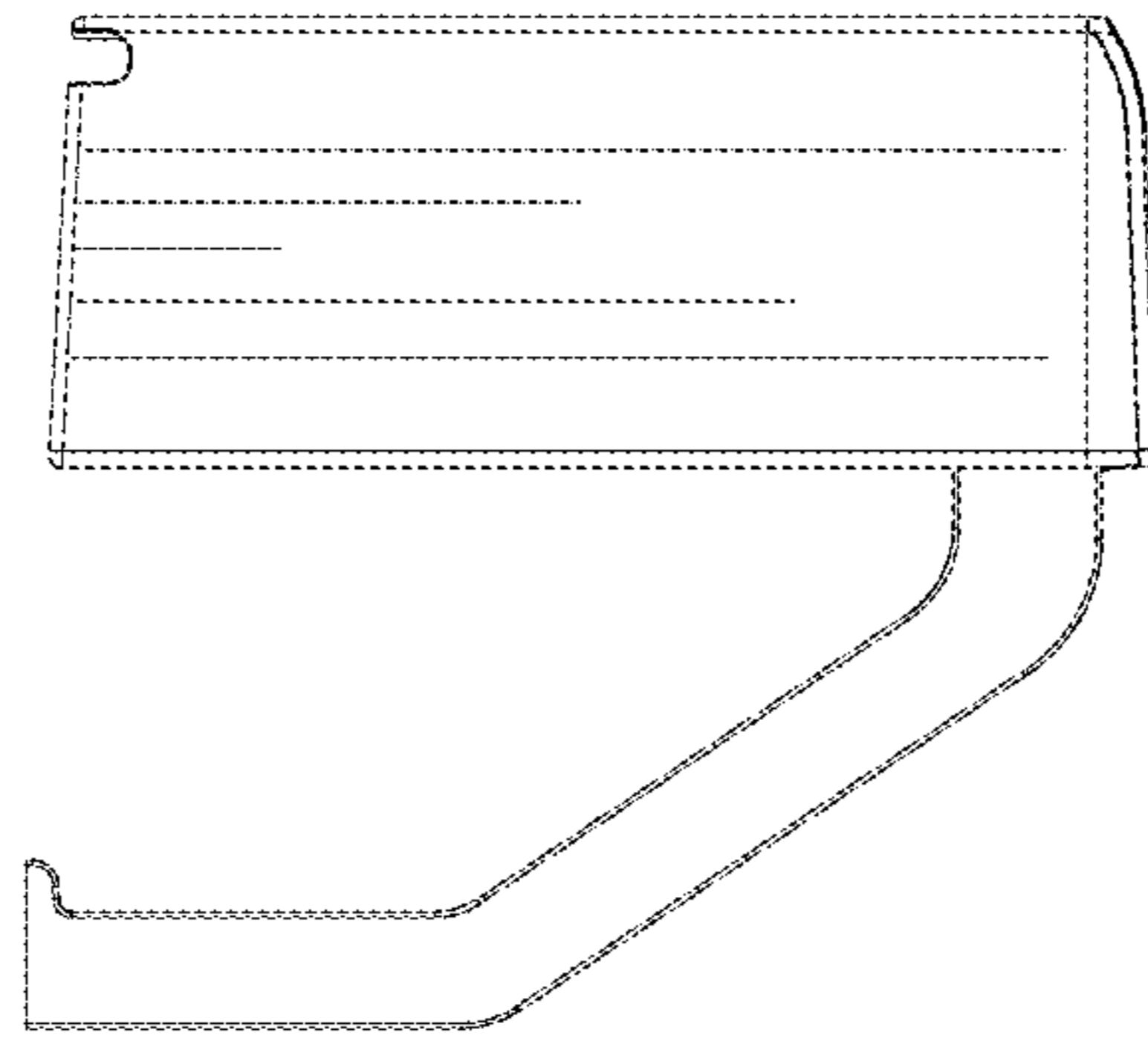

FIG.13

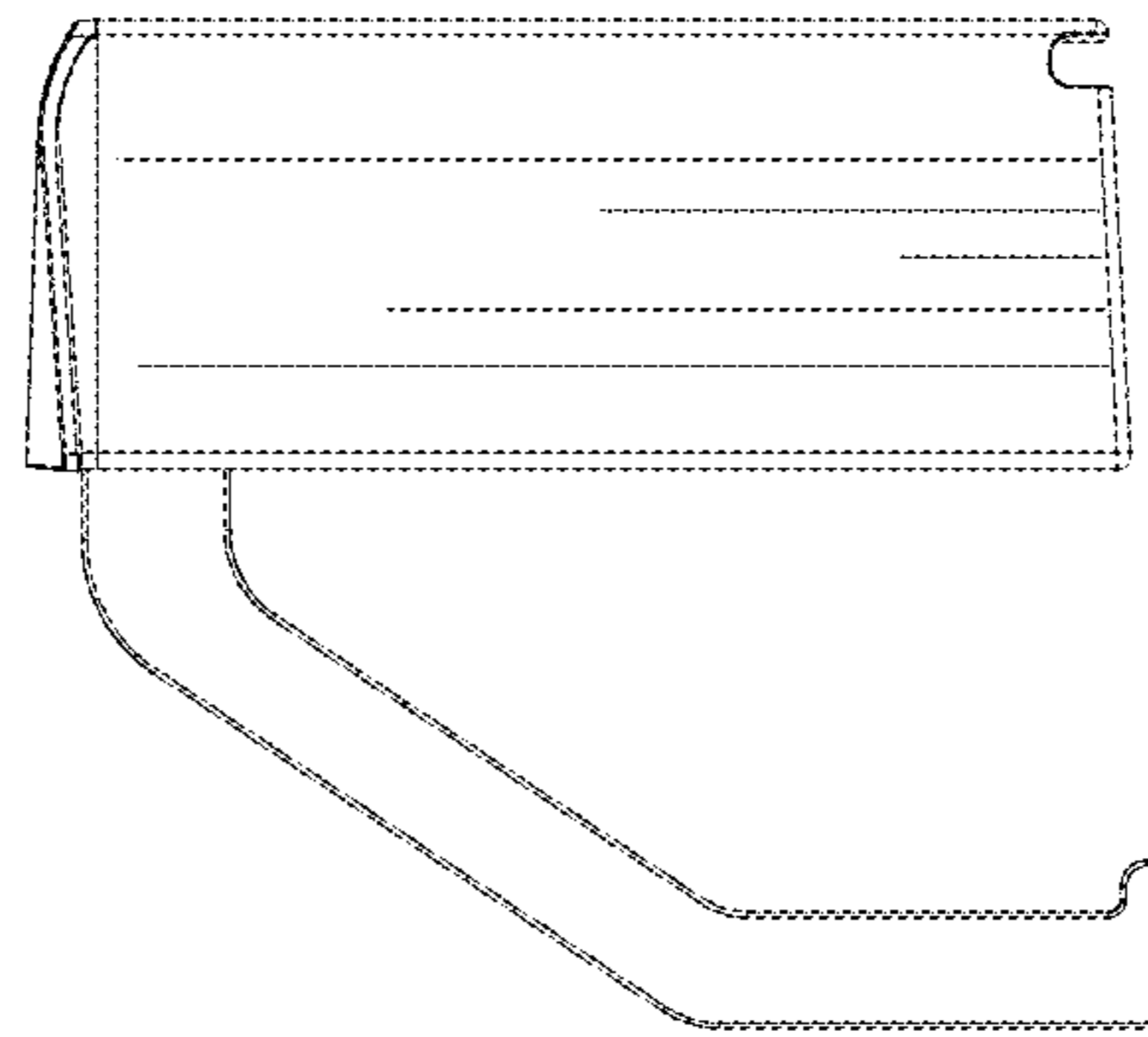

FIG. 14

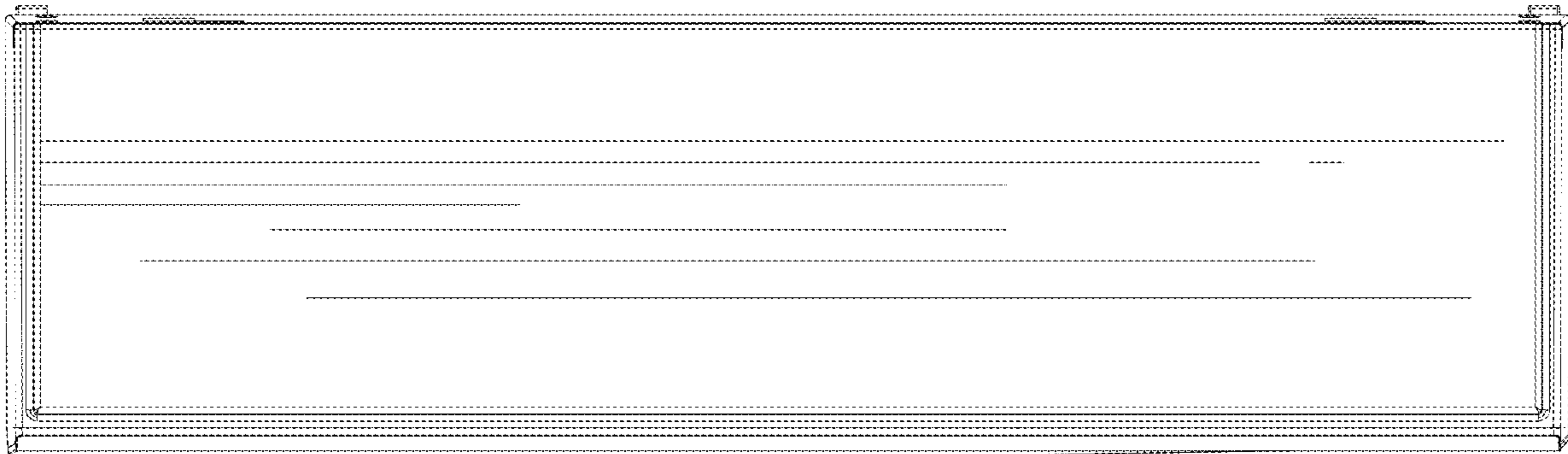

FIG. 15

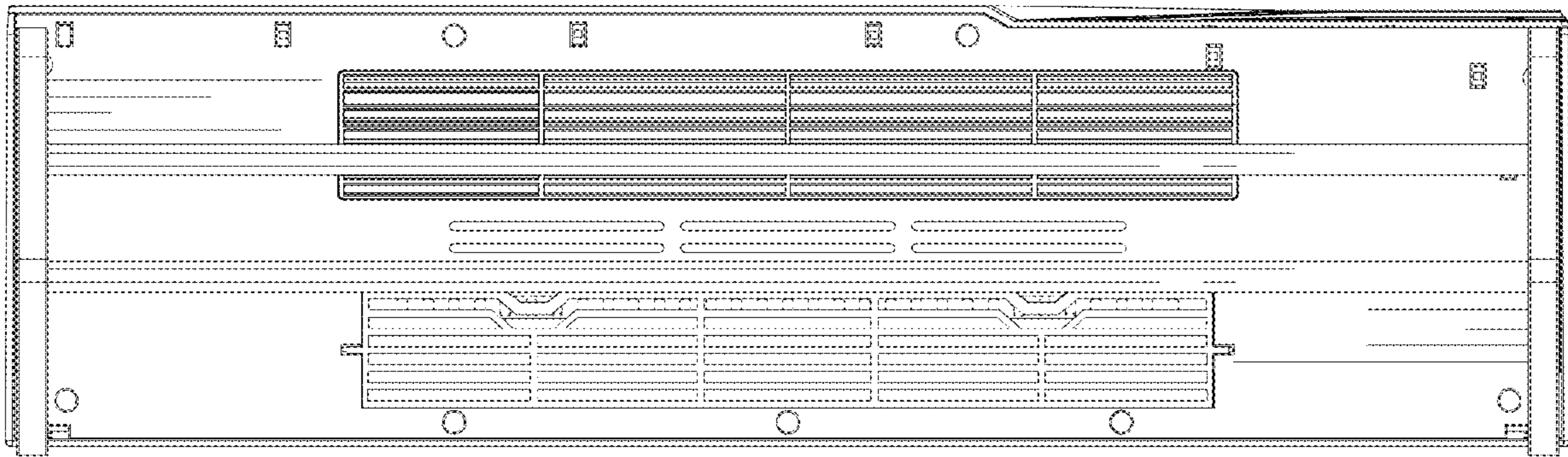

FIG.16