



US00D980371S

(12) **United States Design Patent** (10) **Patent No.:** **US D980,371 S**
Peterson (45) **Date of Patent:** **** Mar. 7, 2023**

(54) **INFLATABLE SLIDE**
(71) Applicant: **SDS Asia Limited, BVI #1748971,**
Hong Kong (CN)
(72) Inventor: **Leroy L. Peterson,** Omaha, NE (US)
(73) Assignee: **SDS Asia Limited, BVI #1748971,**
Central Hong Kong (CN)
(**) Term: **15 Years**
(21) Appl. No.: **29/776,595**
(22) Filed: **Mar. 31, 2021**
(51) **LOC (14) Cl.** **21-03**
(52) **U.S. Cl.**
USPC **D21/818**
(58) **Field of Classification Search**
USPC D21/811, 818, 819, 832, 835, 814, 815,
D21/816, 584, 438, 542, 547
See application file for complete search history.

D870,225 S * 12/2019 Peterson D21/818
2002/0055309 A1 * 5/2002 Gordon B63B 34/52
441/130
2007/0101488 A1 * 5/2007 Ferraro A63G 21/18
4/496

OTHER PUBLICATIONS

Wow world of watersports, announced 2020 [online], [site visited
May 31, 2022]. Available o internet, URL:https://www.bjs.com/
product/wow-soaker-inflatable-pool-slide (Year: 2020).*

* cited by examiner

Primary Examiner — Khawaja Anwar
Assistant Examiner — Julice Seung Eun Oum
(74) *Attorney, Agent, or Firm* — Suiter Swantz pc llo

(57) **CLAIM**

The ornamental design for an inflatable slide, as shown and
described.

DESCRIPTION

FIG. 1 is a perspective view showing our new design;
FIG. 2 is a top plan view thereof;
FIG. 3 is a bottom plan view thereof;
FIG. 4 is a right side elevation view thereof;
FIG. 5 is a left side elevation view thereof;
FIG. 6 is a front side elevation view thereof; and,
FIG. 7 is a rear side elevation view thereof.
The broken lines illustrate portions of the inflatable slide that
form no part of the claimed design.

1 Claim, 7 Drawing Sheets

(56) **References Cited**
U.S. PATENT DOCUMENTS
2,620,185 A * 12/1952 Harding A63G 21/00
D21/818
D340,965 S * 11/1993 Lee D21/818
D472,292 S * 3/2003 Peterson D21/818
D522,082 S * 5/2006 Peterson D21/818
7,682,260 B1 * 3/2010 Whitlock A63G 31/12
472/117
D825,016 S * 8/2018 Wang D21/818
D850,133 S * 6/2019 Voorhees, Jr. D6/361
D857,830 S * 8/2019 Wang D21/818

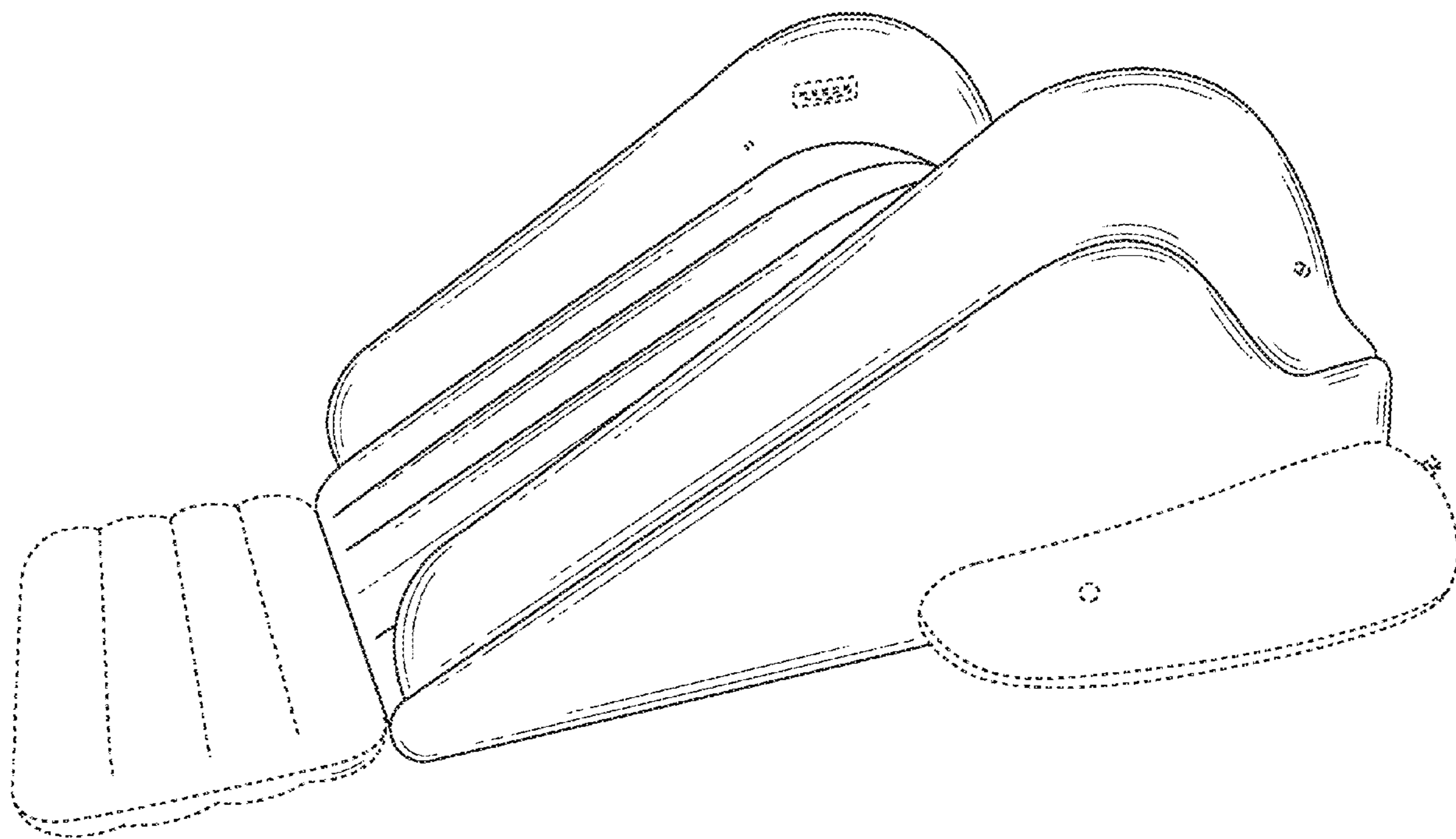

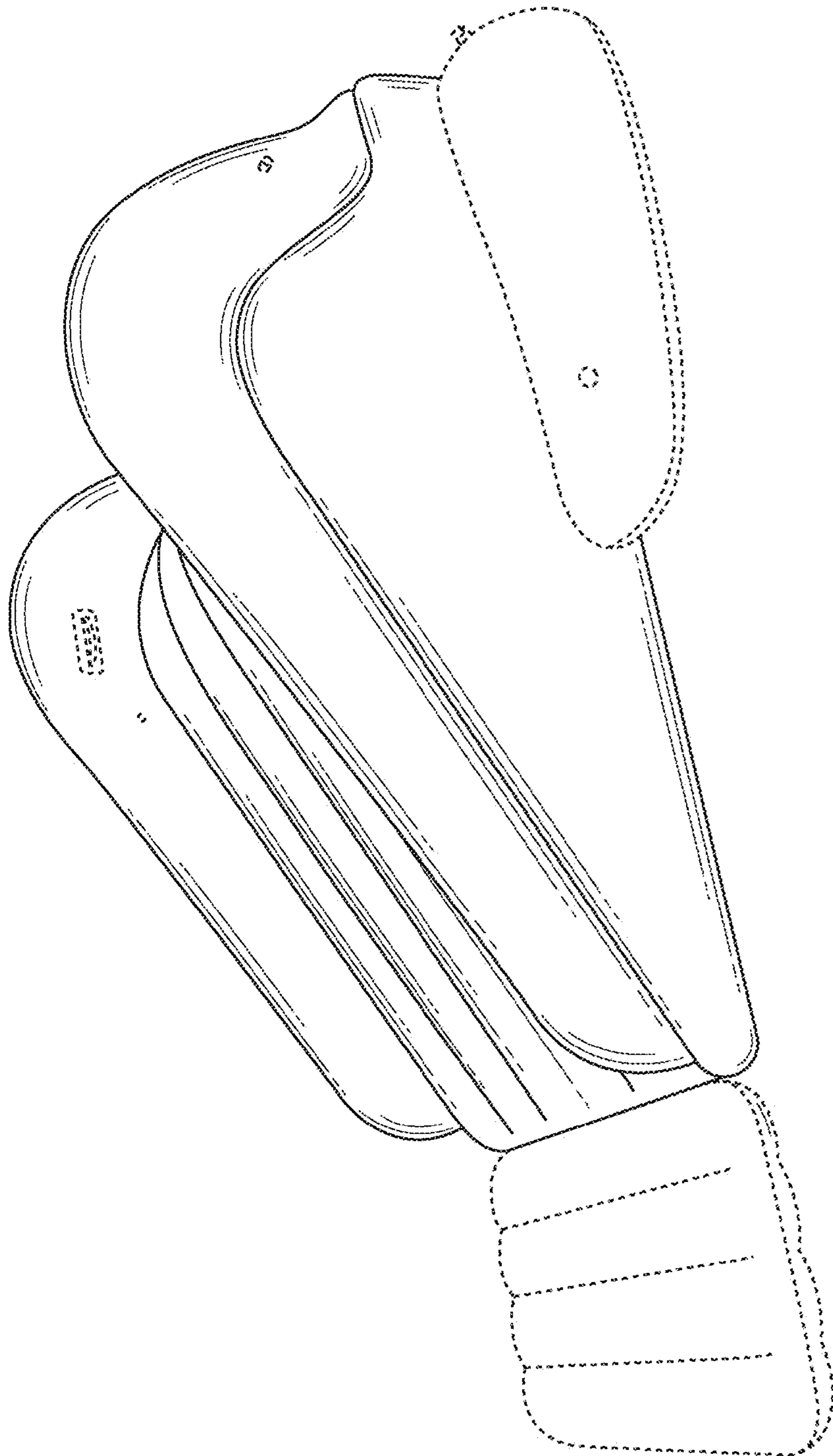

FIG. 1

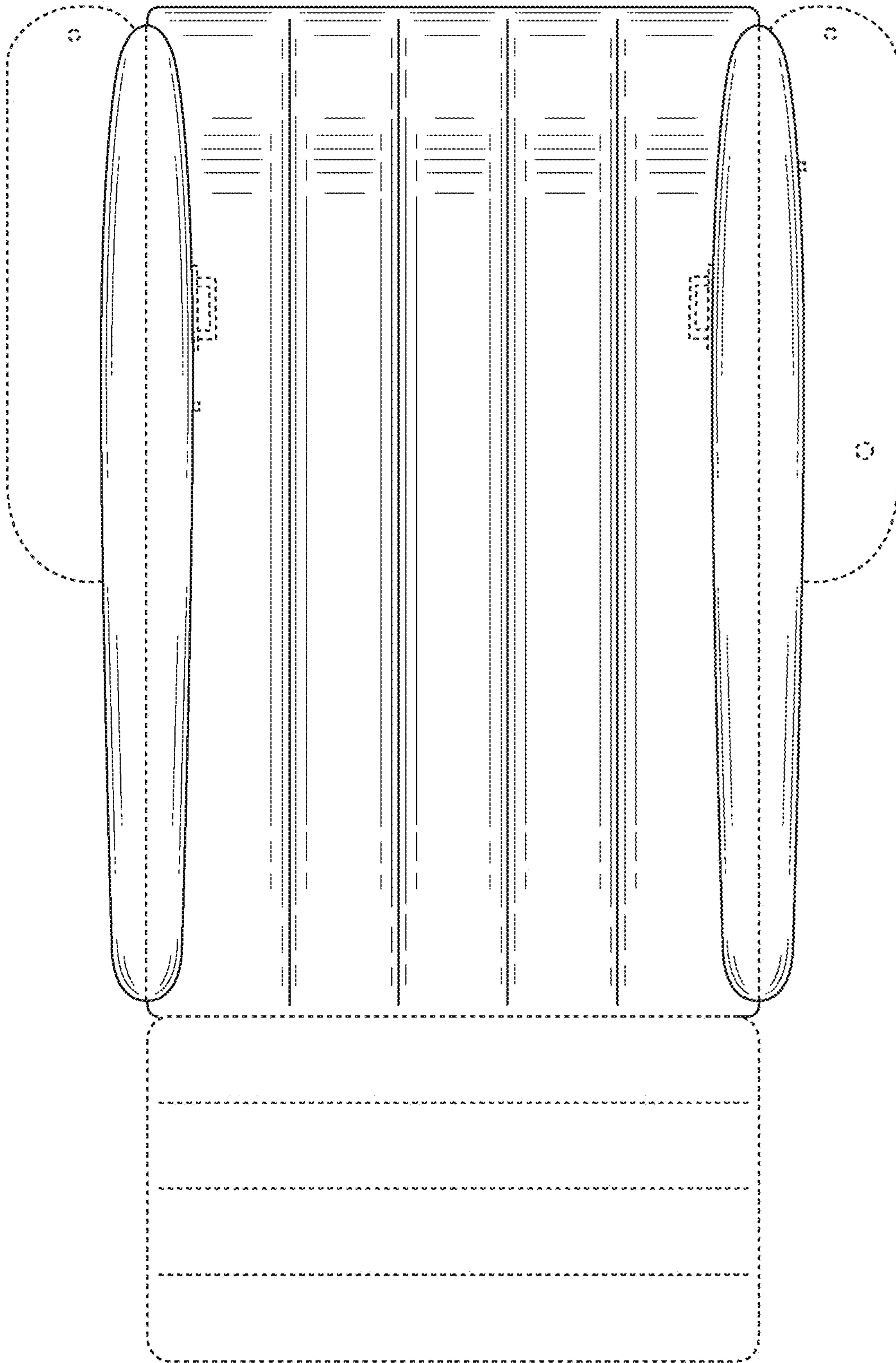

FIG. 2

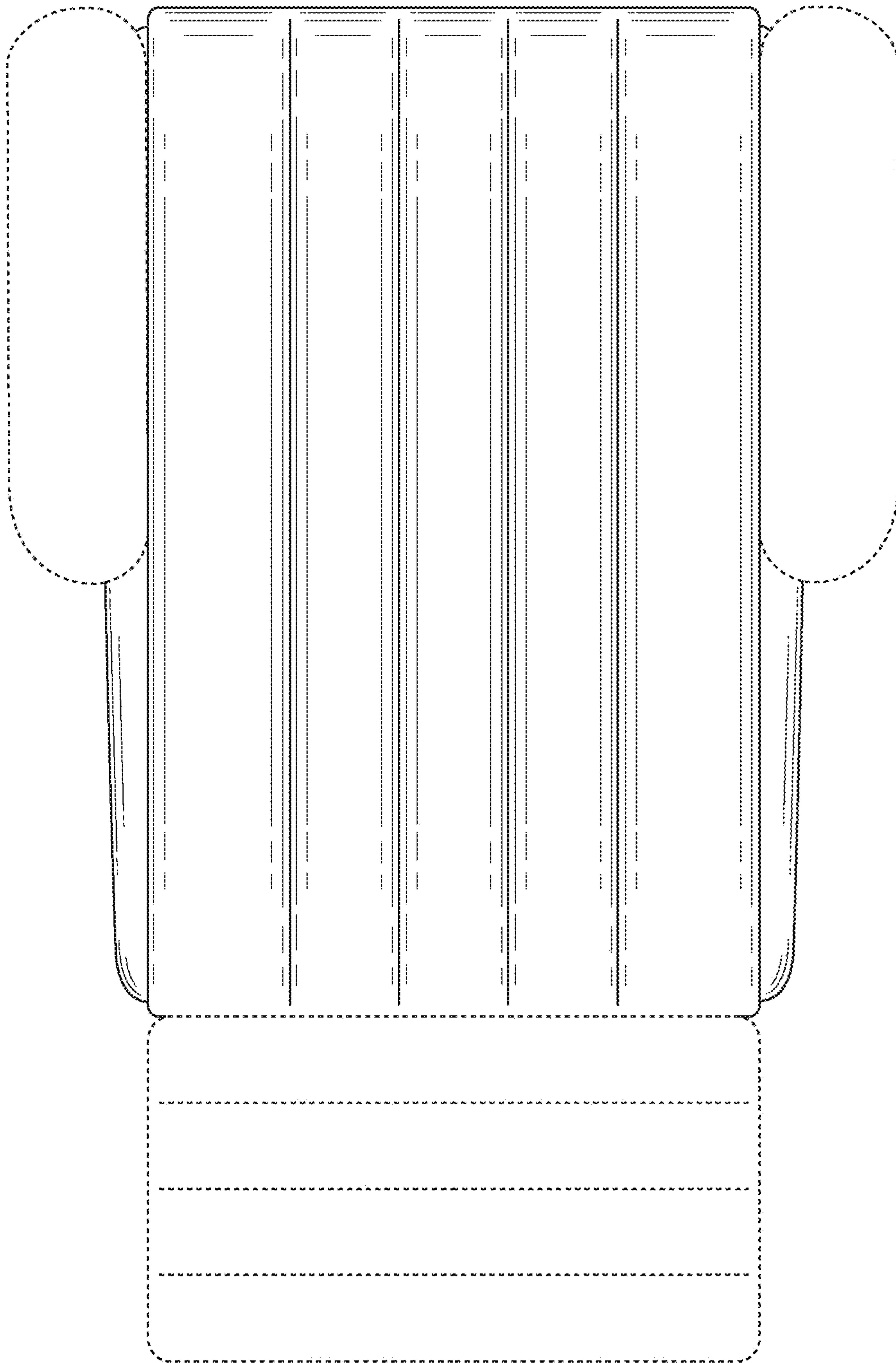

FIG. 3

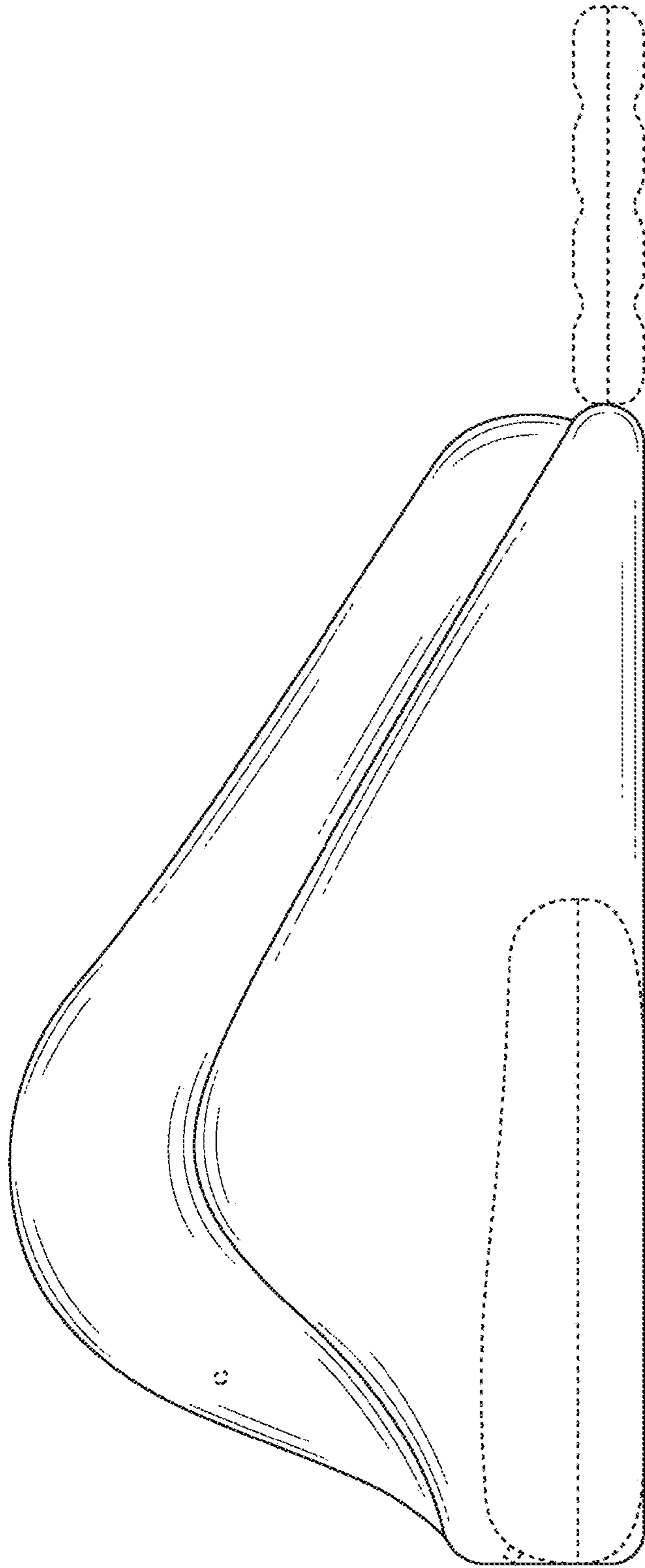

FIG.4

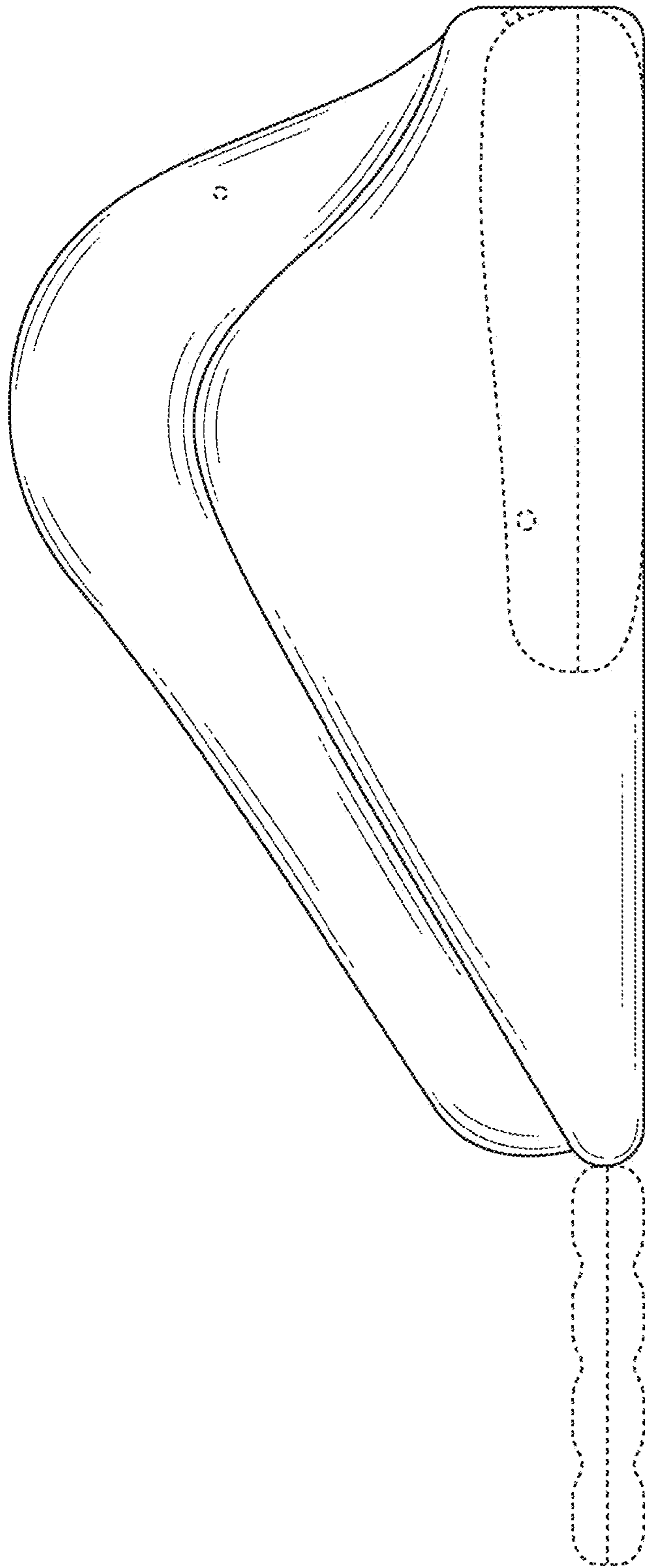

FIG. 5

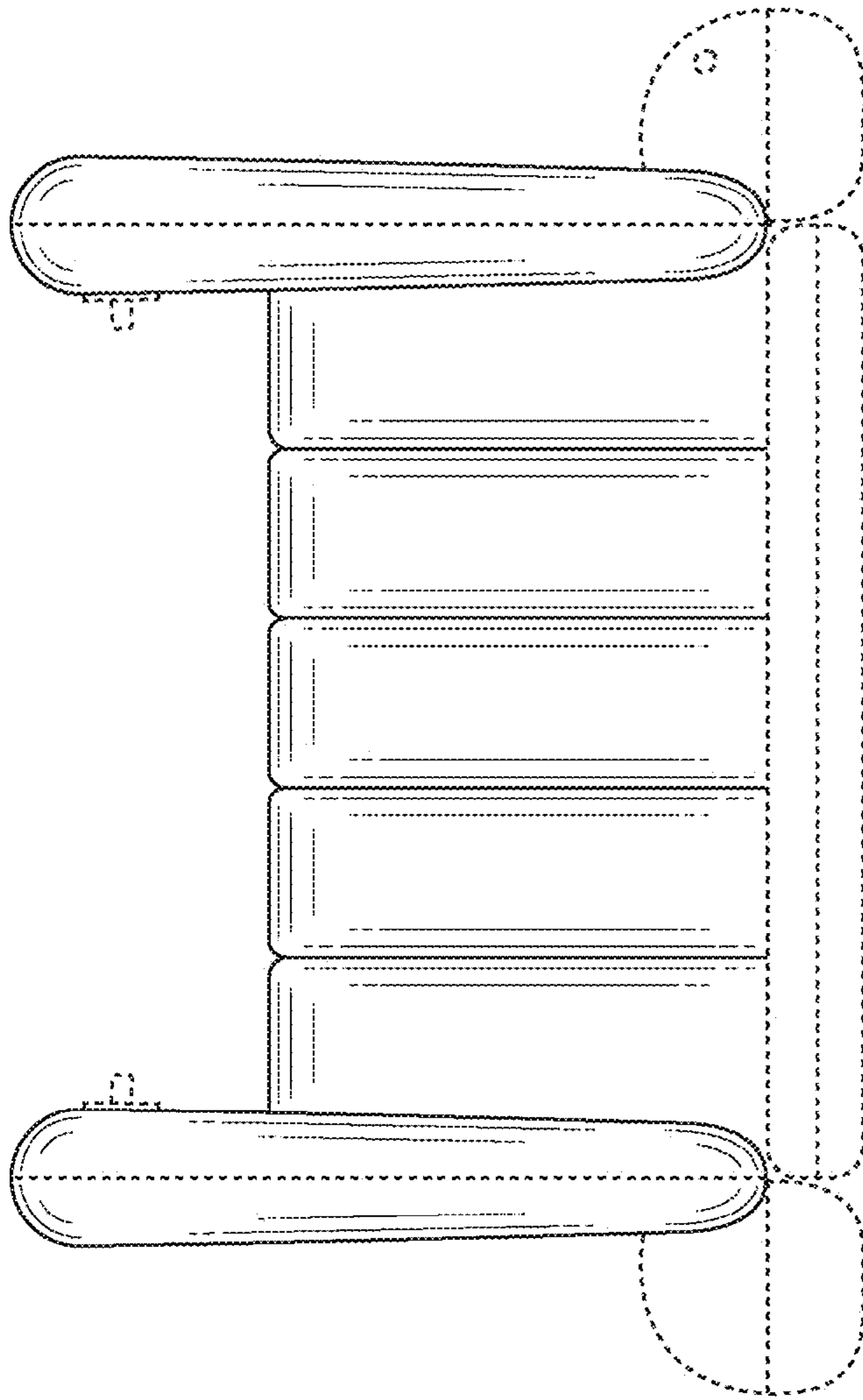

FIG. 6

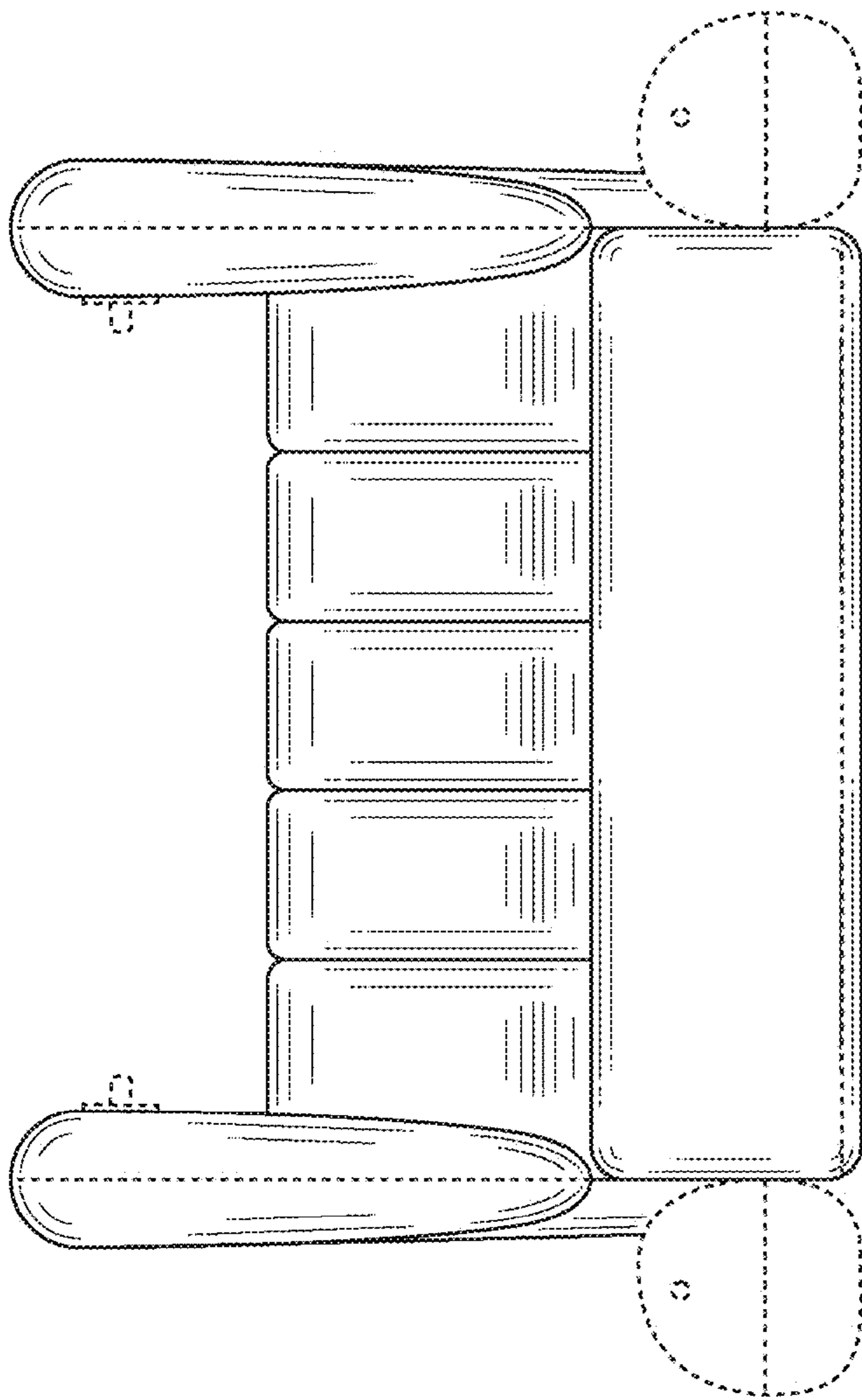

FIG.7