



US00D980347S

(12) **United States Design Patent** (10) **Patent No.:** **US D980,347 S**  
**Jiang** (45) **Date of Patent:** **\*\* Mar. 7, 2023**

(54) **DUMBBELL WEIGHT PLATE**

FOREIGN PATENT DOCUMENTS

(71) Applicant: **MARIETTA INC**, Atlanta, GA (US)

EM 008003958-0001 \* 6/2020

(72) Inventor: **Bo Jiang**, Ningbo (CN)

OTHER PUBLICATIONS

(\*\*) Term: **15 Years**

“AJUMKER Dumbbells Barbell Set” Apr. 26, 2022, Amazon, site visited Oct. 18, 2022: <https://amzn.to/3ESwmbc> (Year: 2022).\*

(21) Appl. No.: **29/752,272**

“20kgs Adjustable Dumbbell Set” Nov. 14, 2020, Youtube, site visited Oct. 18, 2022: <https://www.youtube.com/watch?v=XZBO6NYN0eE> (Year: 2020).\*

(22) Filed: **Sep. 25, 2020**

“XMark Texas Star Olympic Plates” Feb. 16, 2018, Amazon, site visited Oct. 18, 2022: <https://amzn.to/3SdlzLJ> (Year: 2018).\*

(51) **LOC (14) Cl.** ..... **21-02**

(52) **U.S. Cl.**

USPC ..... **D21/680**

(58) **Field of Classification Search**

USPC ..... D6/552; D21/662, 667–682, 684, 685, D21/686, 692, 694

CPC ..... A63B 2220/12; A63B 21/062; A63B 2220/13; A63B 69/3632; A63B 21/075; A63B 21/063; A63B 21/0628; A63B 21/0724

See application file for complete search history.

\* cited by examiner

*Primary Examiner* — Jennifer L Rempfer

*Assistant Examiner* — Salamah Jordan

(74) *Attorney, Agent, or Firm* — Rumit R. Kanakia

(57) **CLAIM**

The ornamental design for a dumbbell weight plate, as shown and described.

**DESCRIPTION**

FIG. 1 is a front elevational view of a dumbbell weight plate showing my new design;

FIG. 2 is a rear elevational view thereof;

FIG. 3 is a left side view thereof;

FIG. 4 is a right side view thereof;

FIG. 5 is a top plan view thereof;

FIG. 6 is a bottom plan view thereof;

FIG. 7 is a perspective view from right side thereof; and,

FIG. 8 is a perspective view from back side thereof.

The broken lines in the drawing depict portions of the dumbbell weight plate that form no part of the claimed design.

(56) **References Cited**

U.S. PATENT DOCUMENTS

D692,970 S *	11/2013	Lien	.....	D21/681
D739,482 S *	9/2015	Lien	.....	D21/681
D740,379 S *	10/2015	Lien	.....	D21/681
D802,064 S *	11/2017	Hillson	.....	D21/681
D851,184 S *	6/2019	McConnell	.....	D21/662
D888,849 S *	6/2020	Bowers	.....	D21/681
D937,943 S *	12/2021	Rothschild	.....	D21/680
D961,698 S *	8/2022	Henniger	.....	D21/680
D962,364 S *	8/2022	Lin	.....	D21/681
D962,365 S *	8/2022	Lin	.....	D21/681
2017/0113088 A1 *	4/2017	Hollingshead	.....	A63B 21/075

**1 Claim, 8 Drawing Sheets**

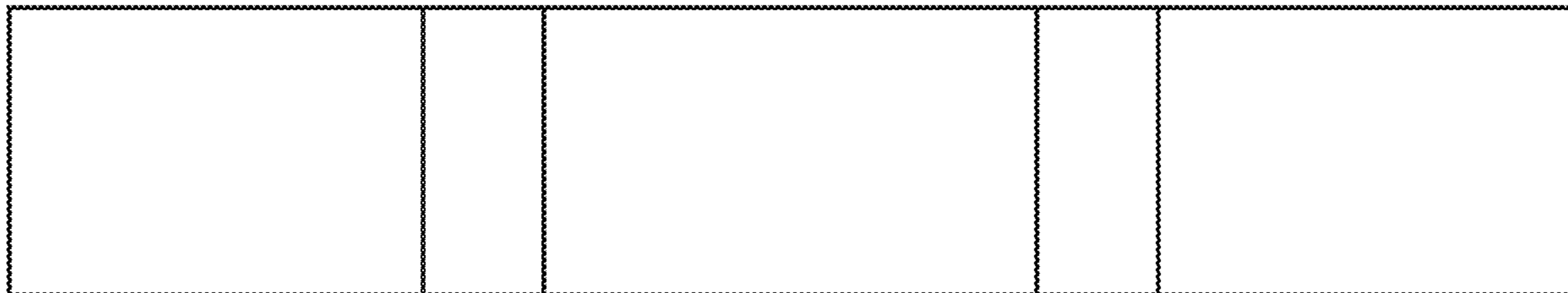



Fig. 1



Fig. 2

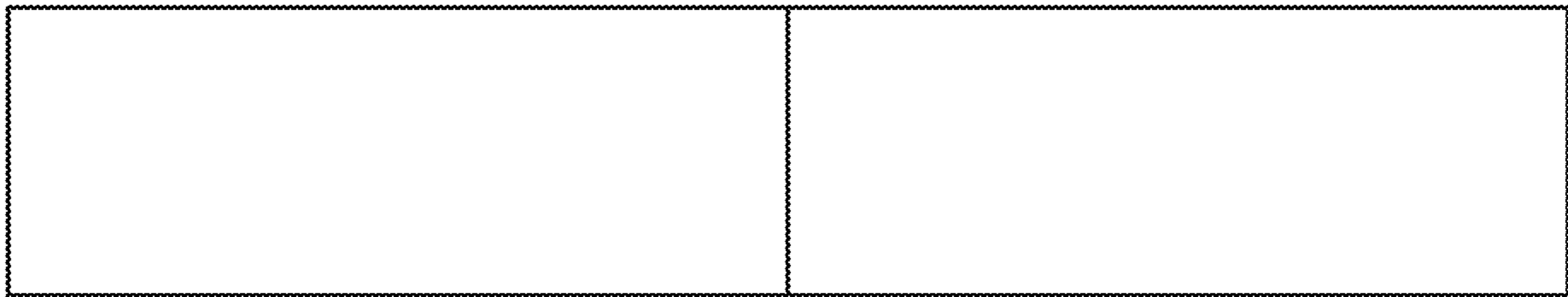

Fig. 3

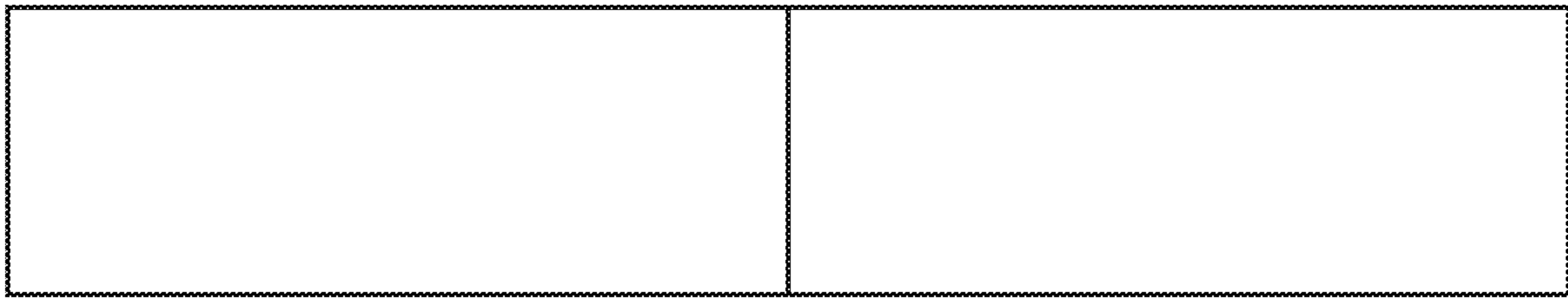

Fig. 4

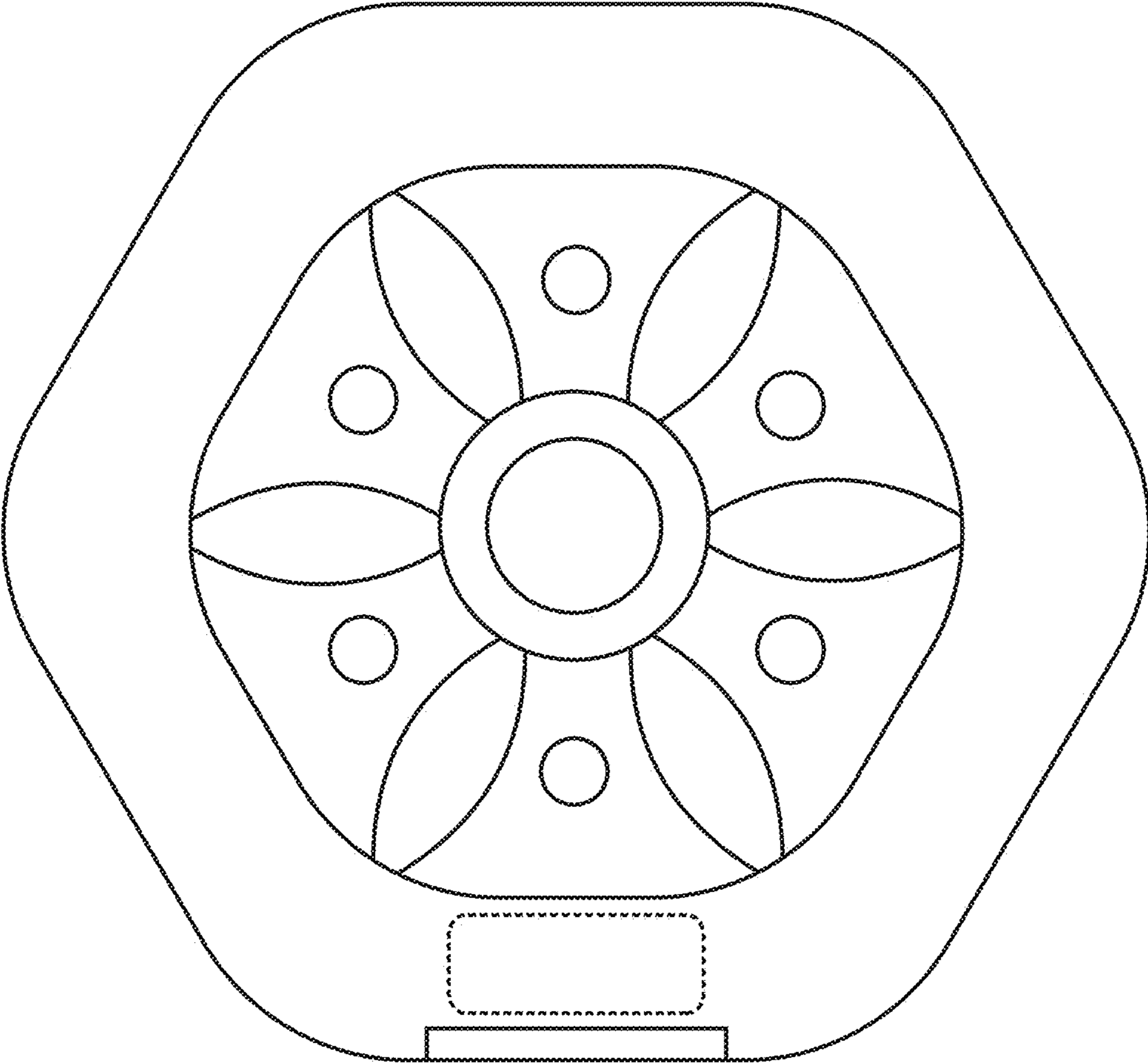

Fig. 5

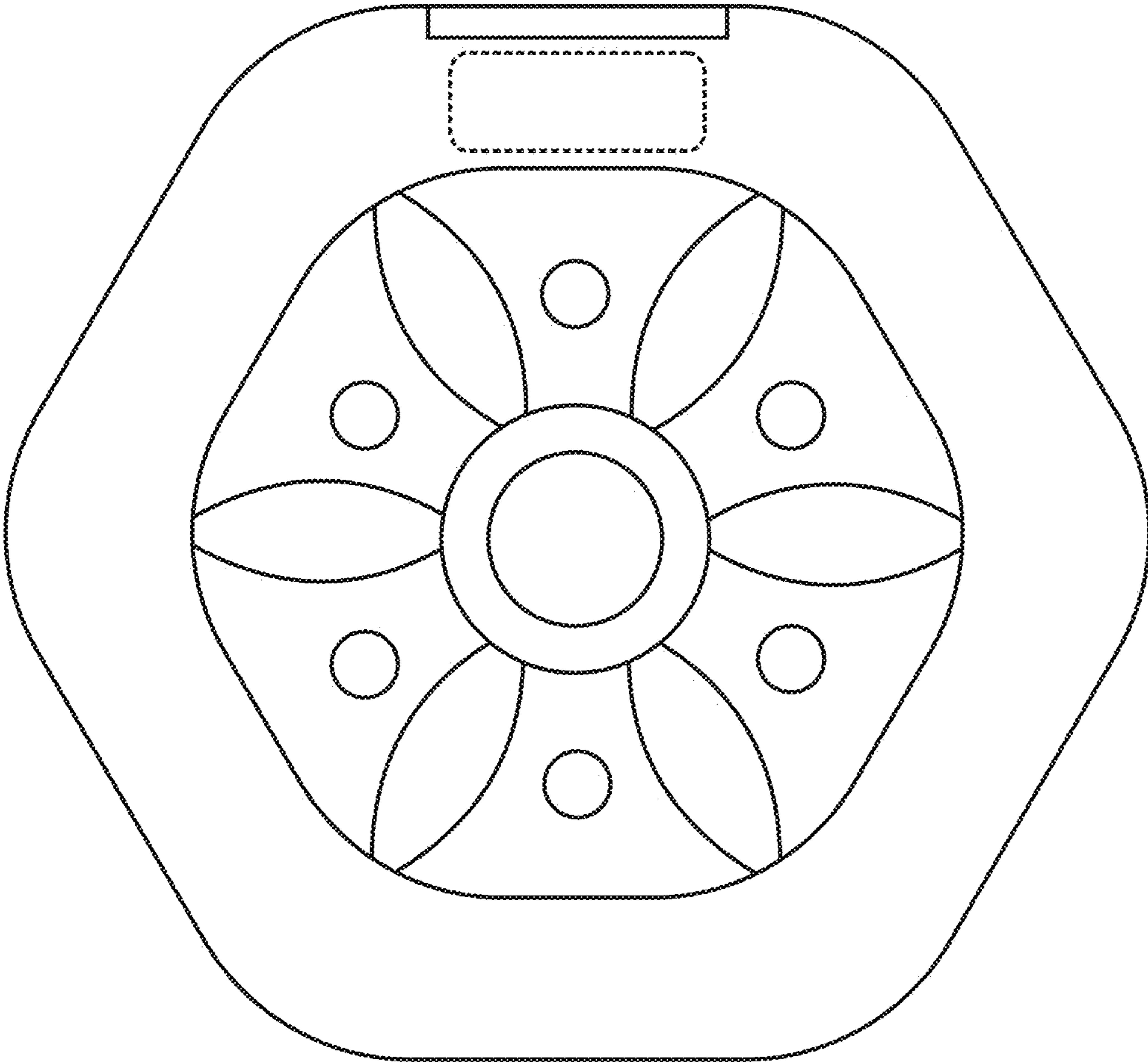

Fig. 6

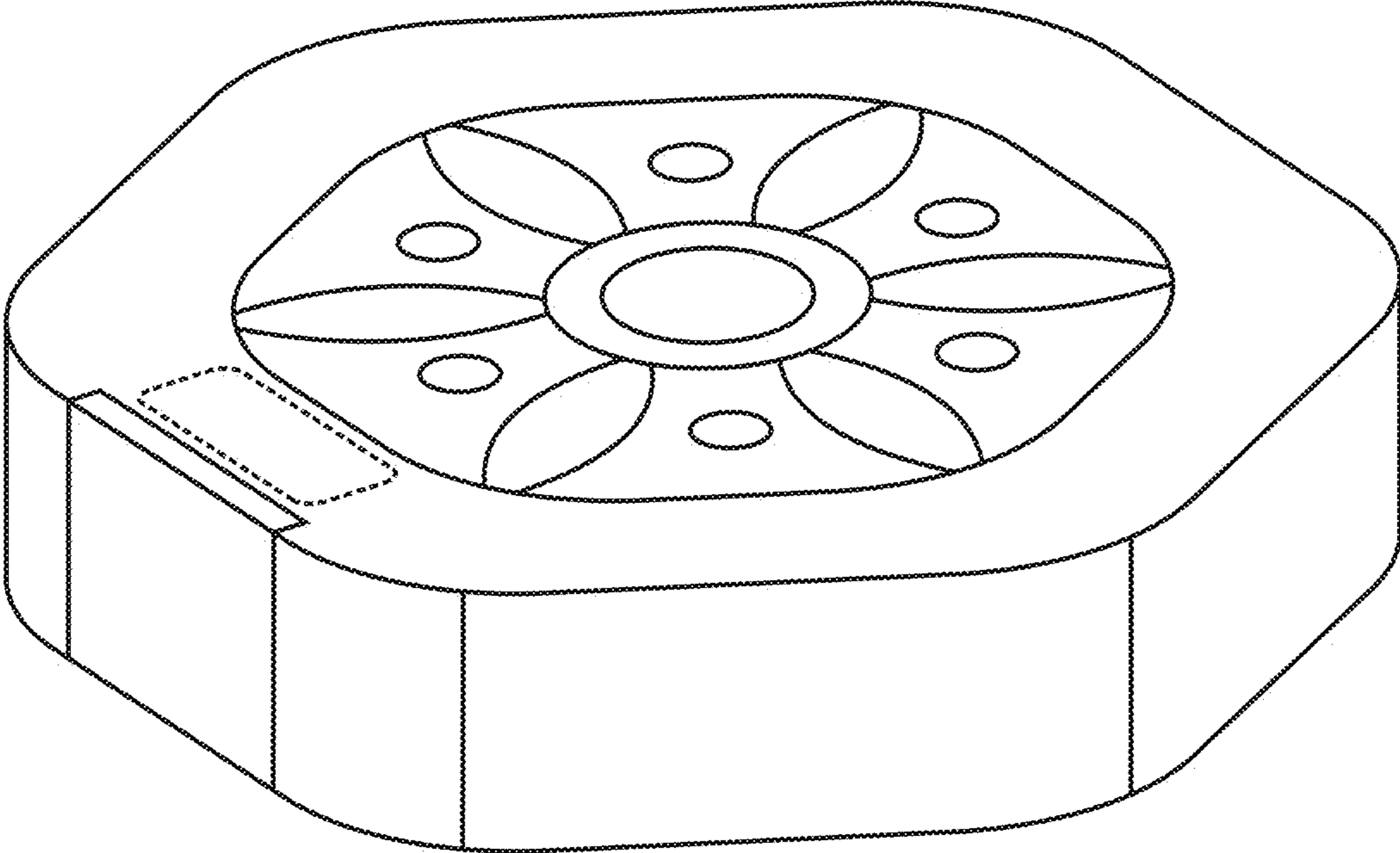

Fig. 7



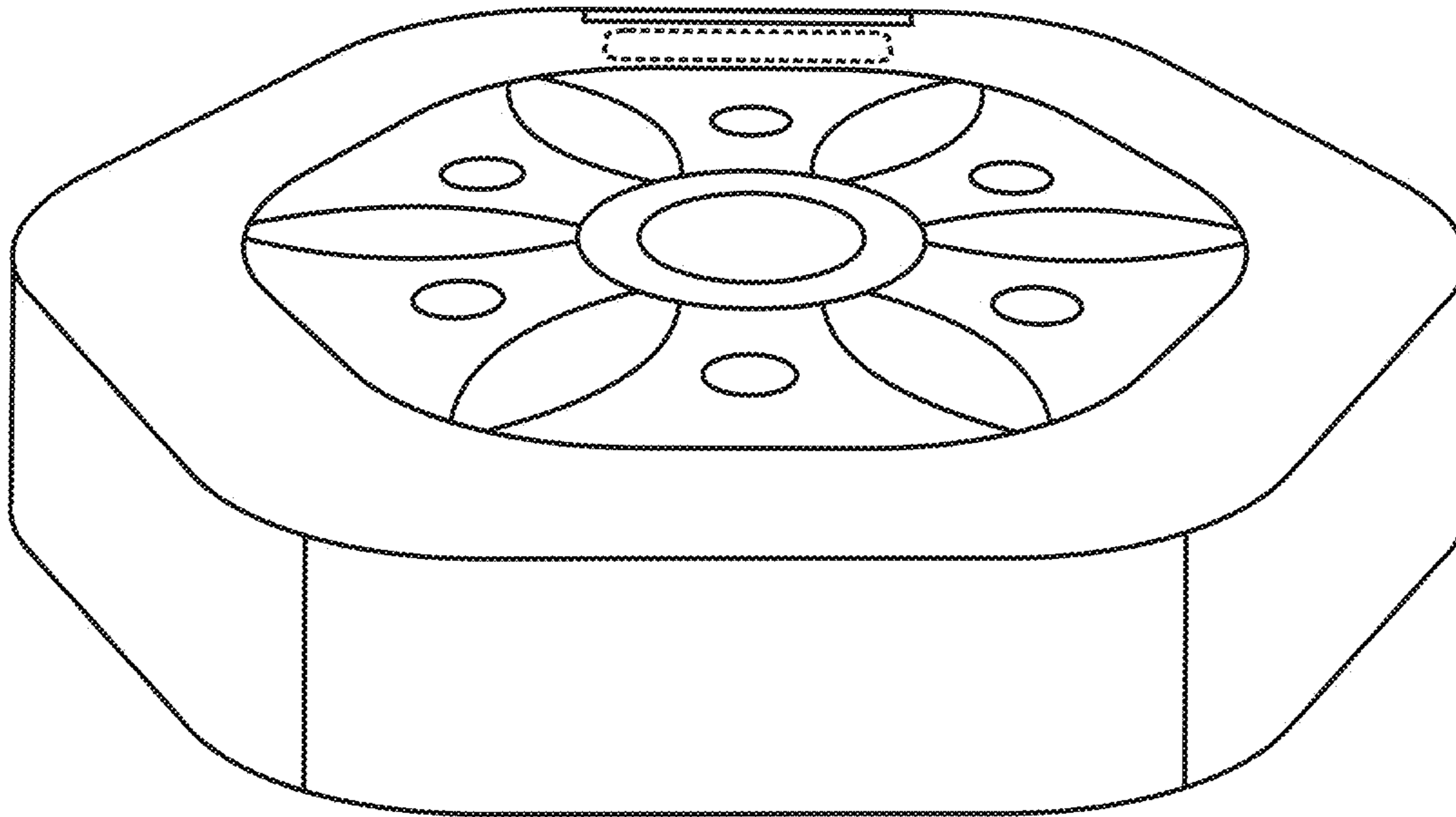

Fig. 8