



US00D980296S

(12) **United States Design Patent**
Harada et al.

(10) **Patent No.:** **US D980,296 S**
(45) **Date of Patent:** **** Mar. 7, 2023**

(54) **CUTTING TOOL**

(71) Applicants: **Sumitomo Electric Industries, Ltd.**,
Osaka (JP); **SUMITOMO ELECTRIC**
HARDMETAL CORP., Itami (JP)

(72) Inventors: **Masashi Harada**, Osaka (JP); **Takashi**
Harada, Osaka (JP); **Satoru Kukino**,
Itami (JP); **Taisuke Higashi**, Itami (JP)

(73) Assignees: **Sumitomo Electric Industries, Ltd.**,
Osaka (JP); **Sumitomo Electric**
Hardmetal Corp., Itami (JP)

(**) Term: **15 Years**

(21) Appl. No.: **29/669,938**

(22) Filed: **Nov. 13, 2018**

(30) **Foreign Application Priority Data**

May 14, 2018 (JP) 2018-010391
May 14, 2018 (JP) 2018-010392
(Continued)

(51) **LOC (14) Cl.** **15-09**

(52) **U.S. Cl.**
USPC **D15/139**

(58) **Field of Classification Search**
USPC D15/131, 139
(Continued)

(56) **References Cited**

U.S. PATENT DOCUMENTS

D519,533 S * 4/2006 Frey D15/139
D656,168 S * 3/2012 Omi D15/139
(Continued)

Primary Examiner — Michael C Stout
Assistant Examiner — Fritzgerald L Butac

(74) *Attorney, Agent, or Firm* — Baker Botts L.L.P.;
Michael A. Sartori

(57) **CLAIM**

The ornamental design for a cutting tool, as shown and described.

DESCRIPTION

FIG. 1 is a front view of a cutting tool in accordance with Embodiment 1 of the present design; FIG. 2 is a rear view thereof; FIG. 3 is a right side view thereof; FIG. 4 is a left side view thereof; FIG. 5 is a top view thereof; FIG. 6 is a bottom view thereof; FIG. 7 is a perspective view thereof; FIG. 8 is an enlarged perspective view of 8-8 portion of FIG. 7; FIG. 9 is a front view of a cutting tool in accordance with Embodiment 2 of the present design; FIG. 10 is a rear view thereof; FIG. 11 is a right side view thereof; FIG. 12 is a left side view thereof; FIG. 13 is a top view thereof; FIG. 14 is a bottom view thereof; FIG. 15 is a perspective view thereof; FIG. 16 is an enlarged perspective view of 16-16 portion of FIG. 15; FIG. 17 is a front view of a cutting tool in accordance with Embodiment 3 of the present design; FIG. 18 is a rear view thereof; FIG. 19 is a right side view thereof; FIG. 20 is a left side view thereof; FIG. 21 is a top view thereof; FIG. 22 is a bottom view thereof; FIG. 23 is a perspective view thereof; and, FIG. 24 is an enlarged perspective view of 24-24 portion of FIG. 23. The broken lines shown in the views represent portions of the cutting tool that form no part of the claimed design.

1 Claim, 21 Drawing Sheets

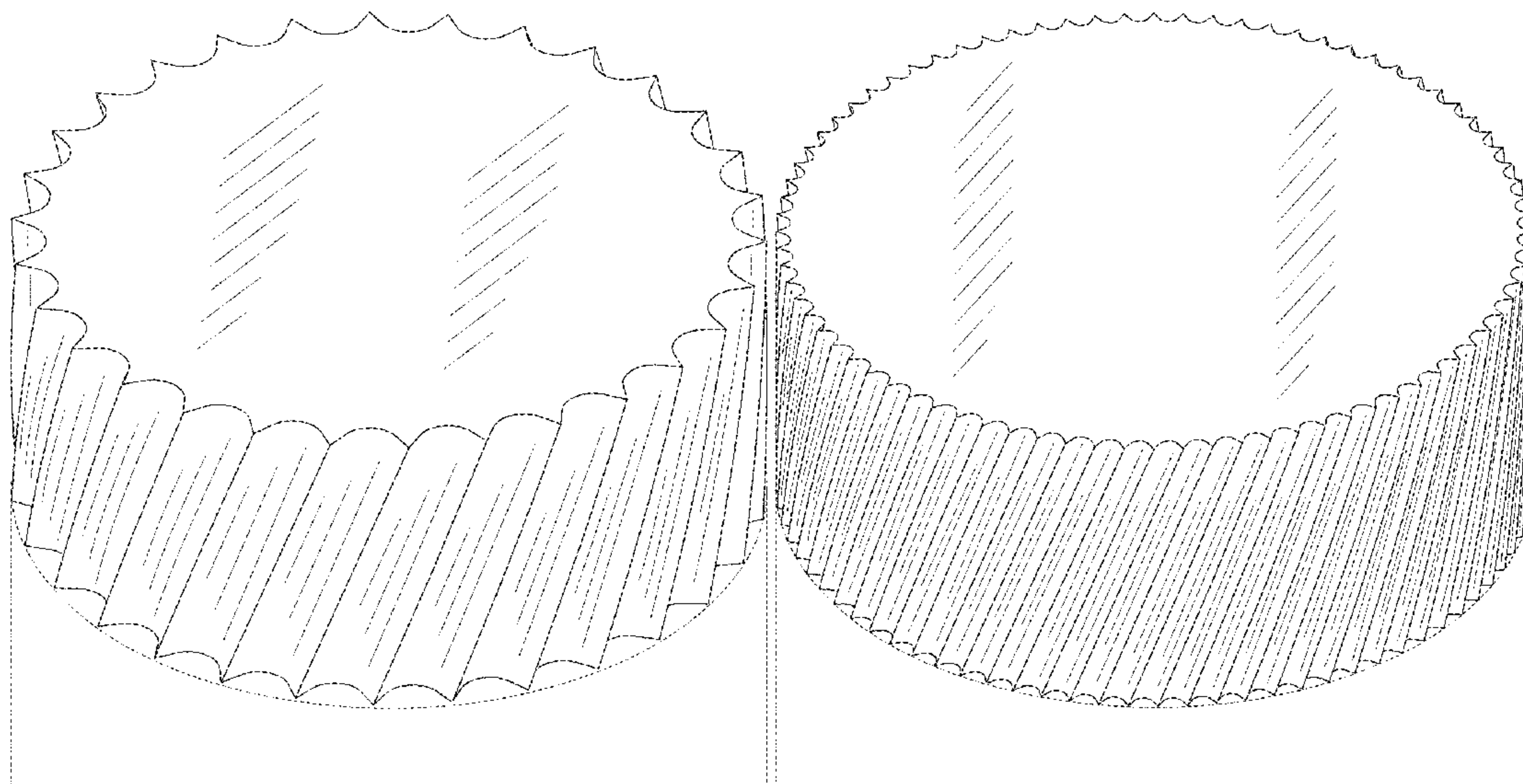

(30) Foreign Application Priority Data

May 14, 2018 (JP) 2018-010393
 May 14, 2018 (JP) 2018-010394
 May 14, 2018 (JP) 2018-010395
 May 14, 2018 (JP) 2018-010396
 May 14, 2018 (JP) 2018-010397
 May 14, 2018 (JP) 2018-010398

(58) Field of Classification Search

CPC B23B 51/0433; B23B 51/0413; B23B
 2251/50; B27G 15/00
 See application file for complete search history.

(56) References Cited

U.S. PATENT DOCUMENTS

D662,529 S * 6/2012 Kirby D15/139
 D692,470 S * 10/2013 Novak D15/139
 D708,650 S * 7/2014 Richter D15/139
 D711,441 S * 8/2014 Novak D15/139
 D735,784 S * 8/2015 O'Malley D15/139

D735,785 S * 8/2015 O'Malley D15/139
 D736,279 S * 8/2015 O'Malley D15/139
 D758,463 S * 6/2016 Kikuchi D15/139
 D781,941 S * 3/2017 Nakamura D15/139
 D815,165 S * 4/2018 Morisaki D15/139
 D816,743 S * 5/2018 Monden D15/139
 D820,329 S * 6/2018 Kanada D15/139
 D826,664 S * 8/2018 Matsubara D15/139
 D831,084 S * 10/2018 Abe D15/139
 D832,317 S * 10/2018 Abe D15/139
 D834,077 S * 11/2018 Monden D15/139
 D834,078 S * 11/2018 Monden D15/139
 D844,034 S * 3/2019 Yano D15/139
 D844,683 S * 4/2019 Yano D15/139
 D865,823 S * 11/2019 Abe D15/139
 D872,145 S * 1/2020 Maeno D15/139
 D920,401 S * 5/2021 Congdon D15/139
 D921,075 S * 6/2021 Park D15/139
 D921,076 S * 6/2021 Park D15/139
 D931,916 S * 9/2021 Shimamoto D15/139
 D936,713 S * 11/2021 Endoh D15/139
 D937,330 S * 11/2021 Kukino D15/139

* cited by examiner

FIG. 1

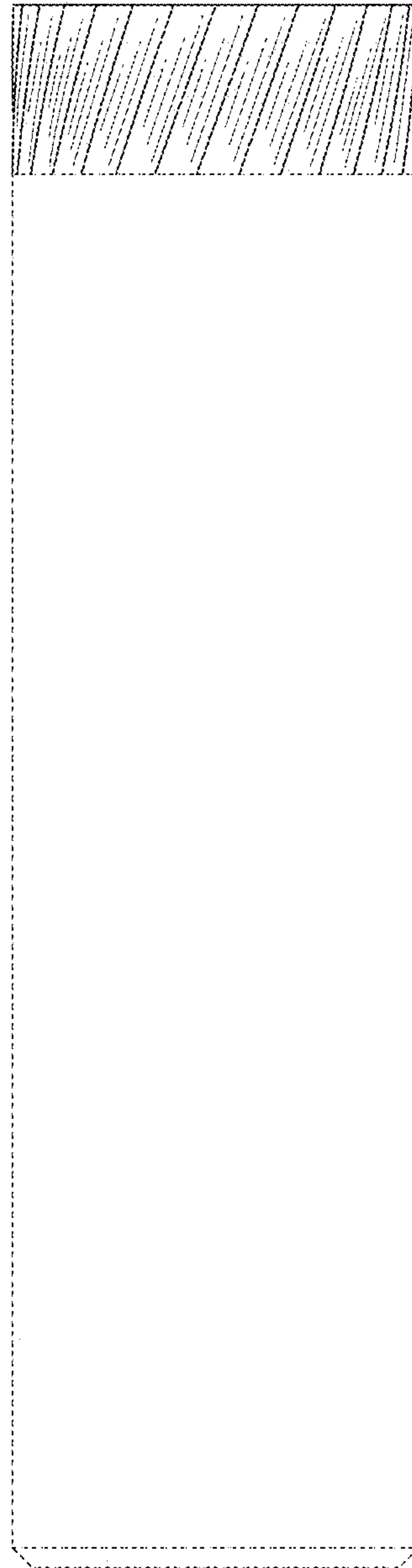

FIG.2



FIG.3

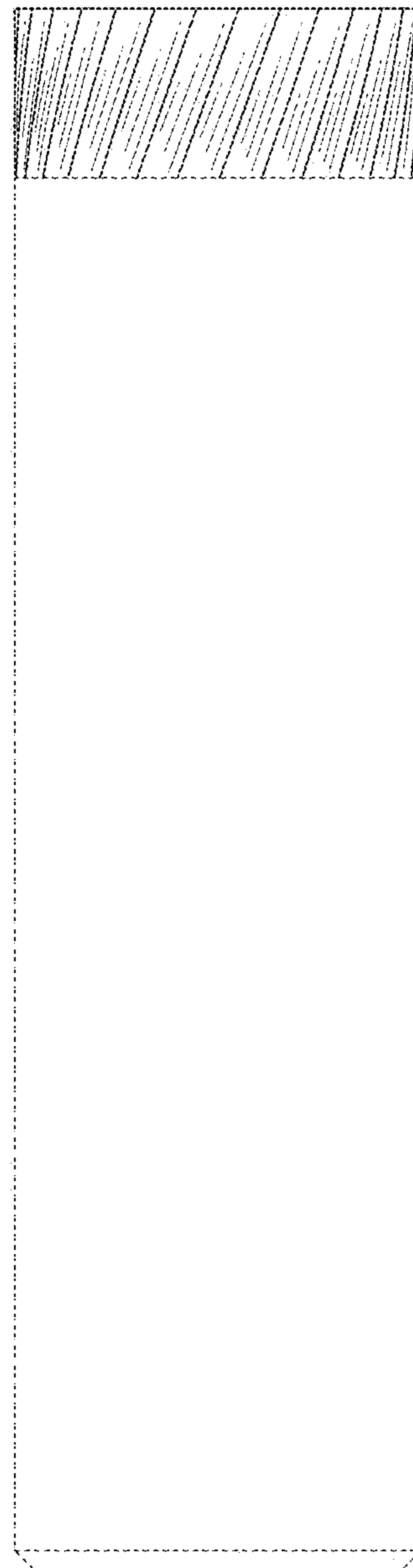

FIG.4

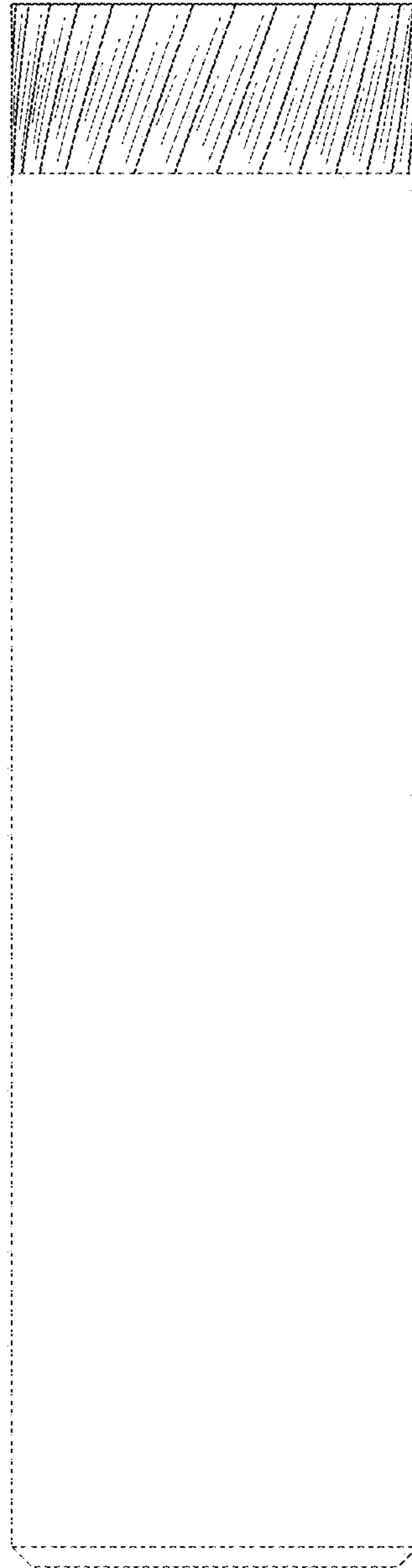

FIG.5

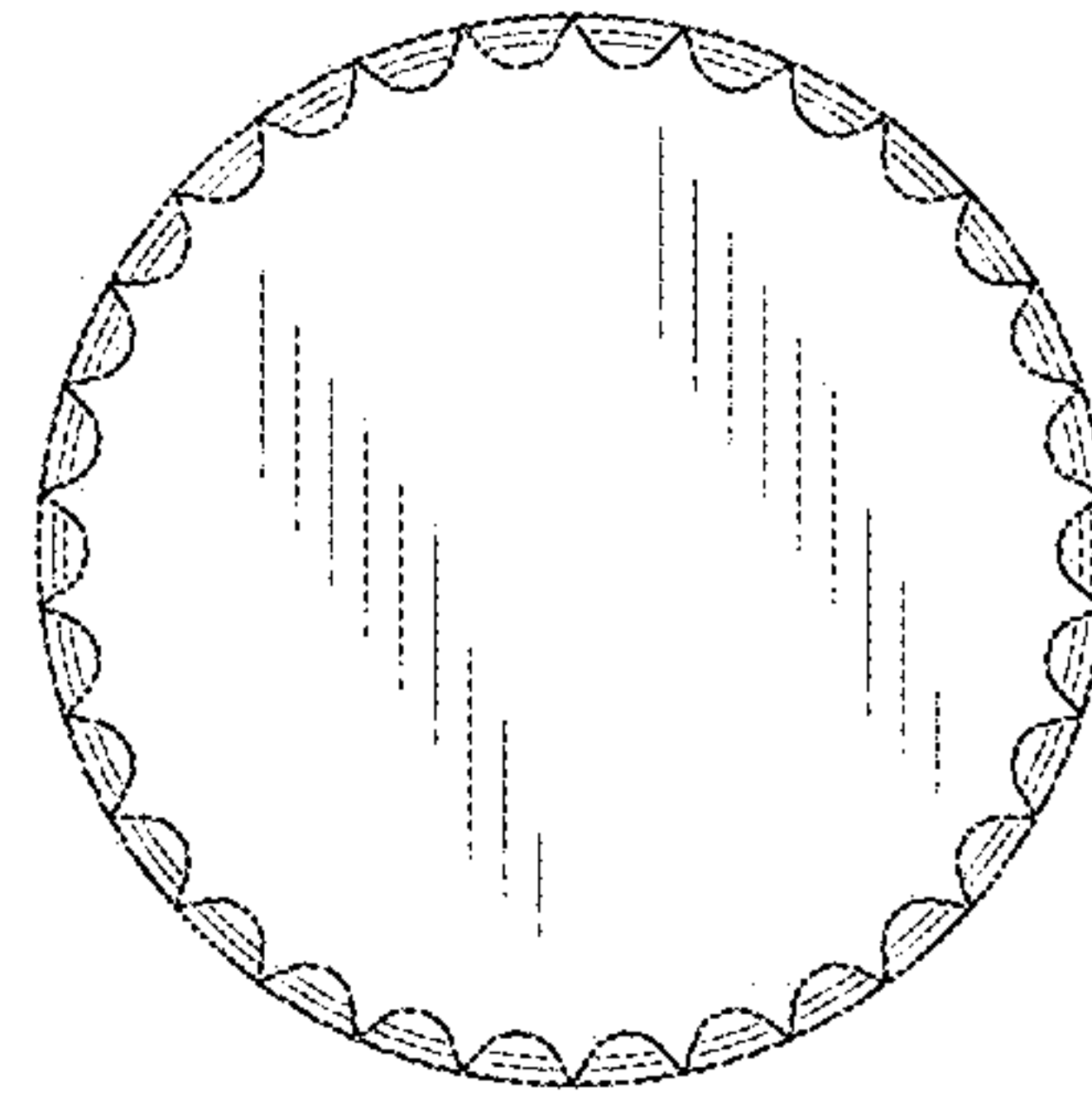

FIG.6

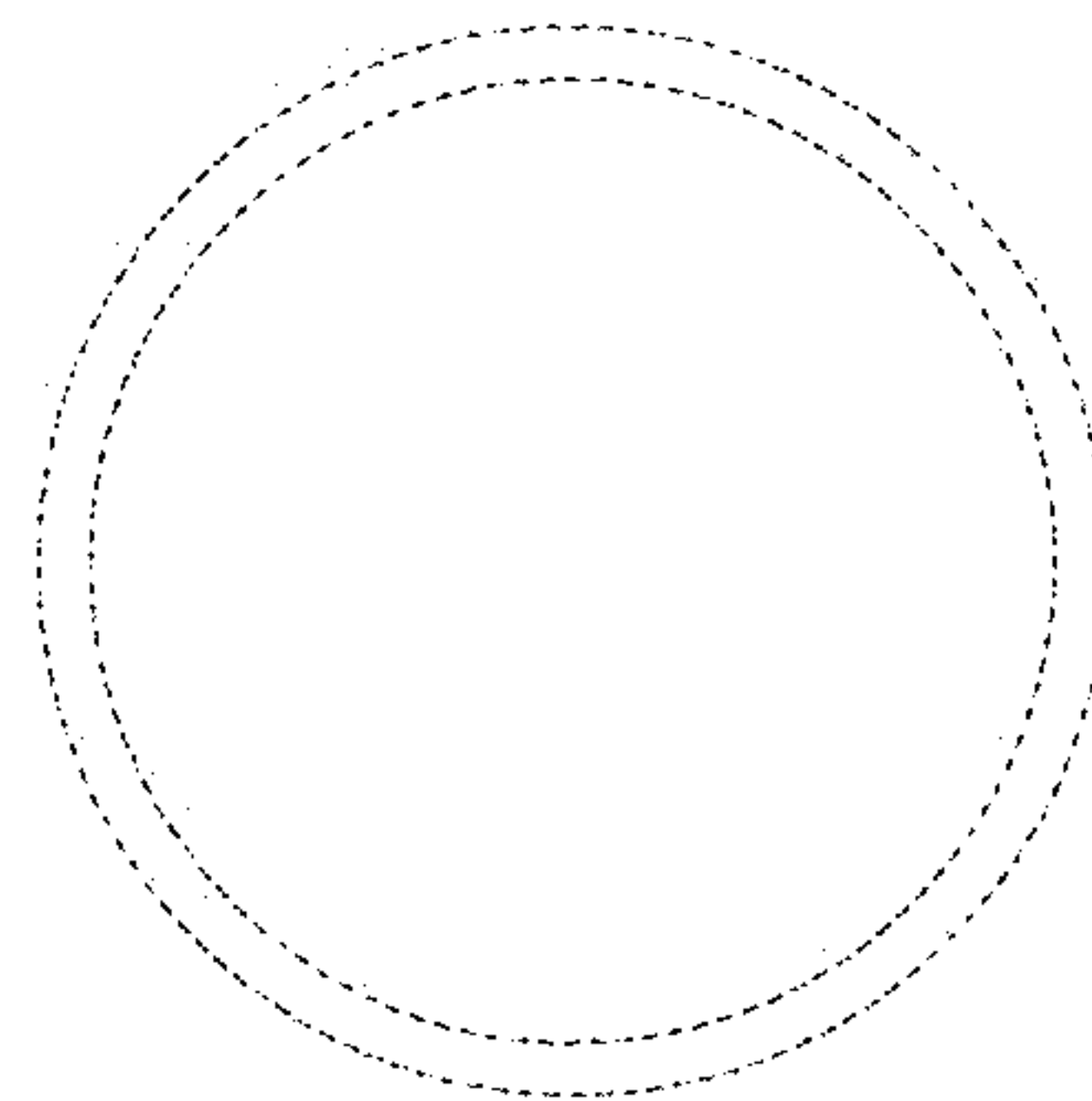

FIG. 7

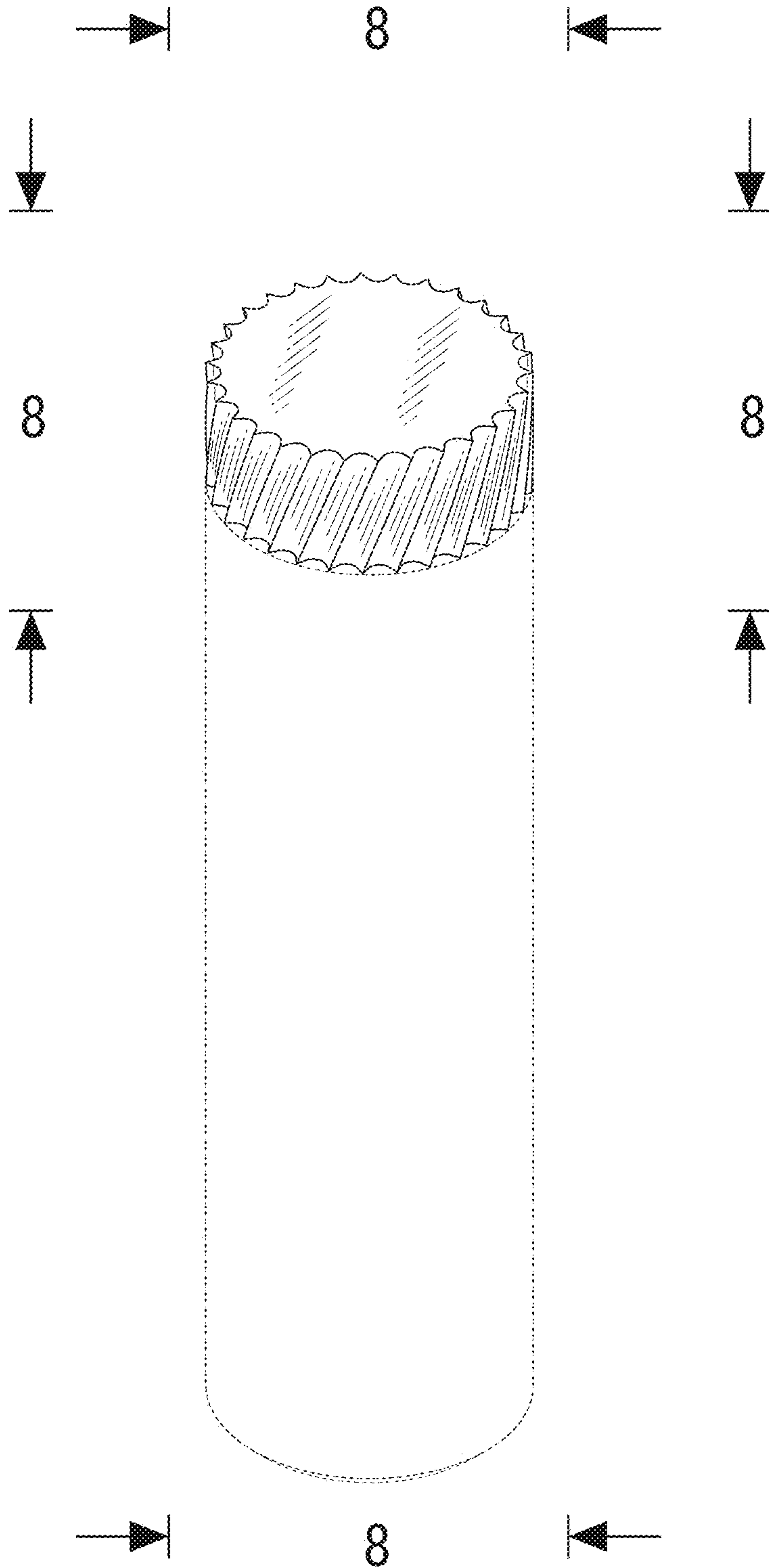

FIG.8

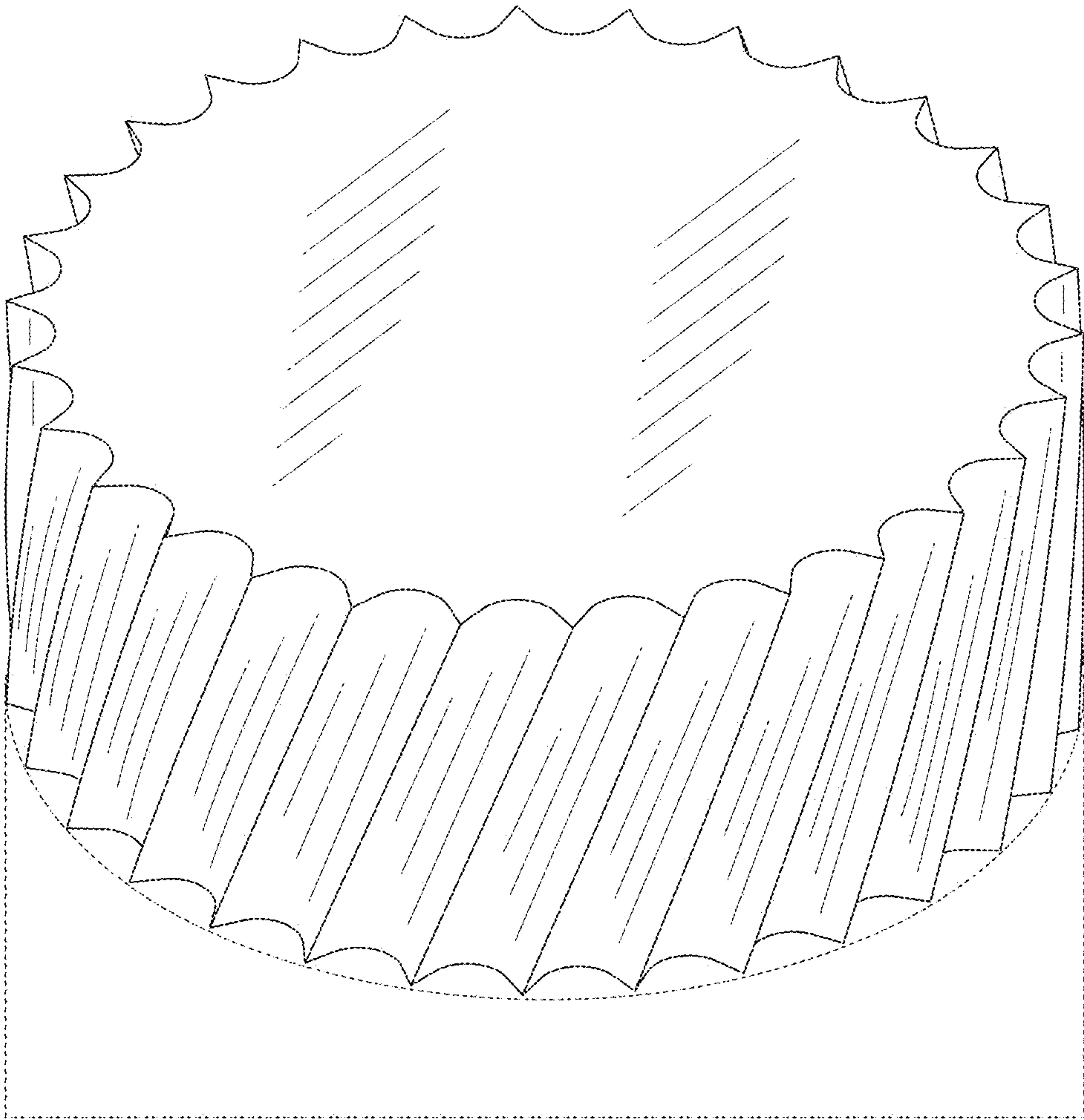

FIG.9

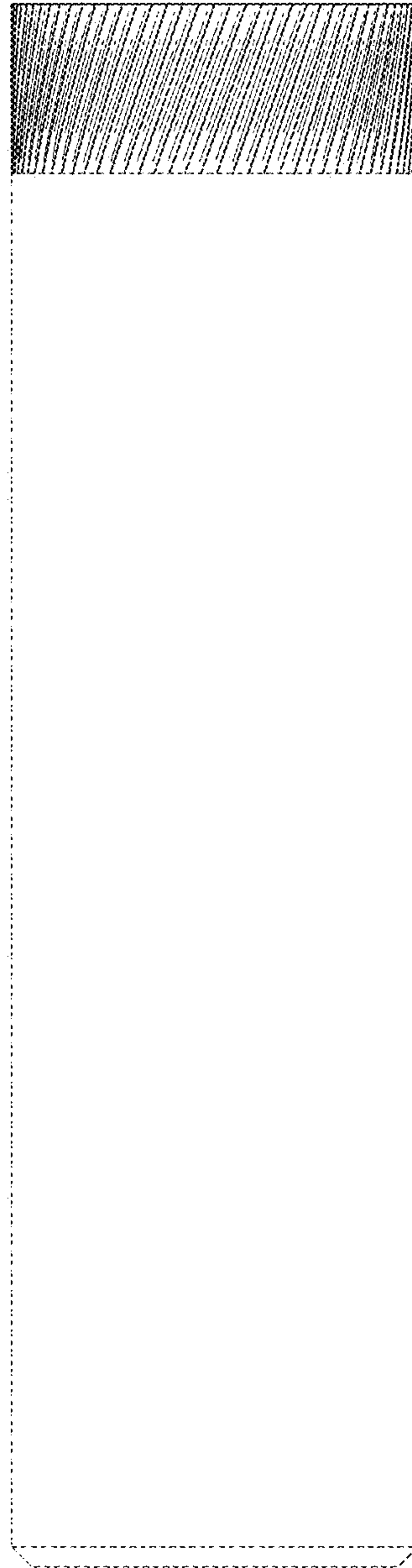

FIG. 10

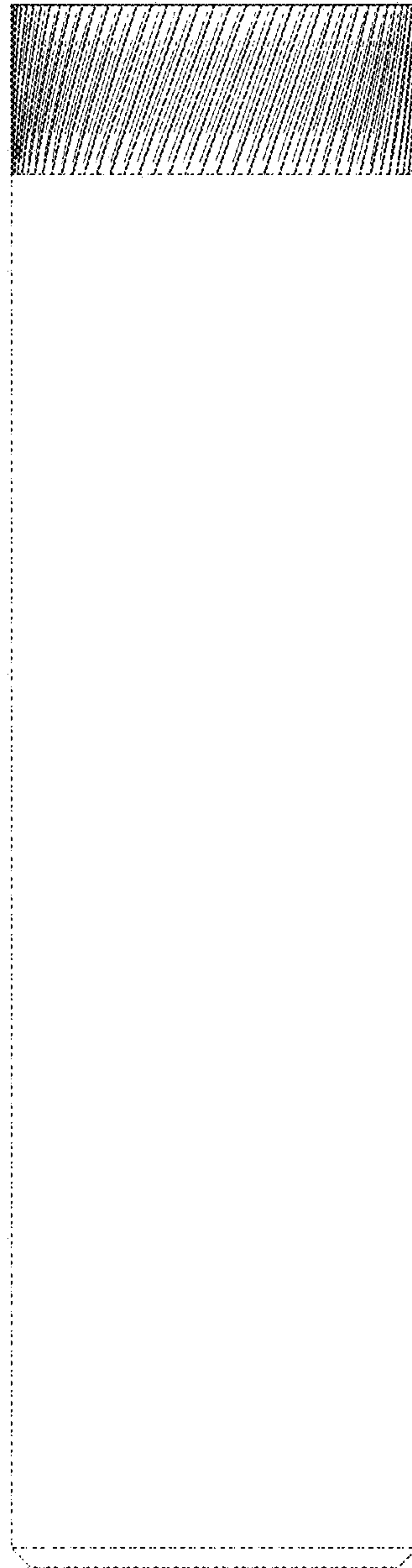

FIG. 11

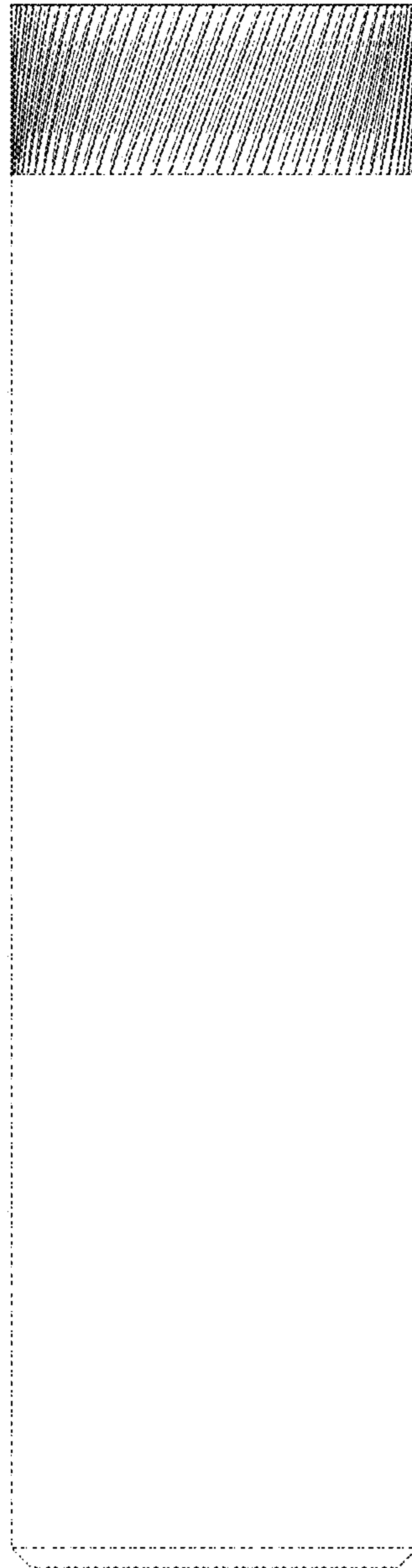

FIG. 12



FIG.13

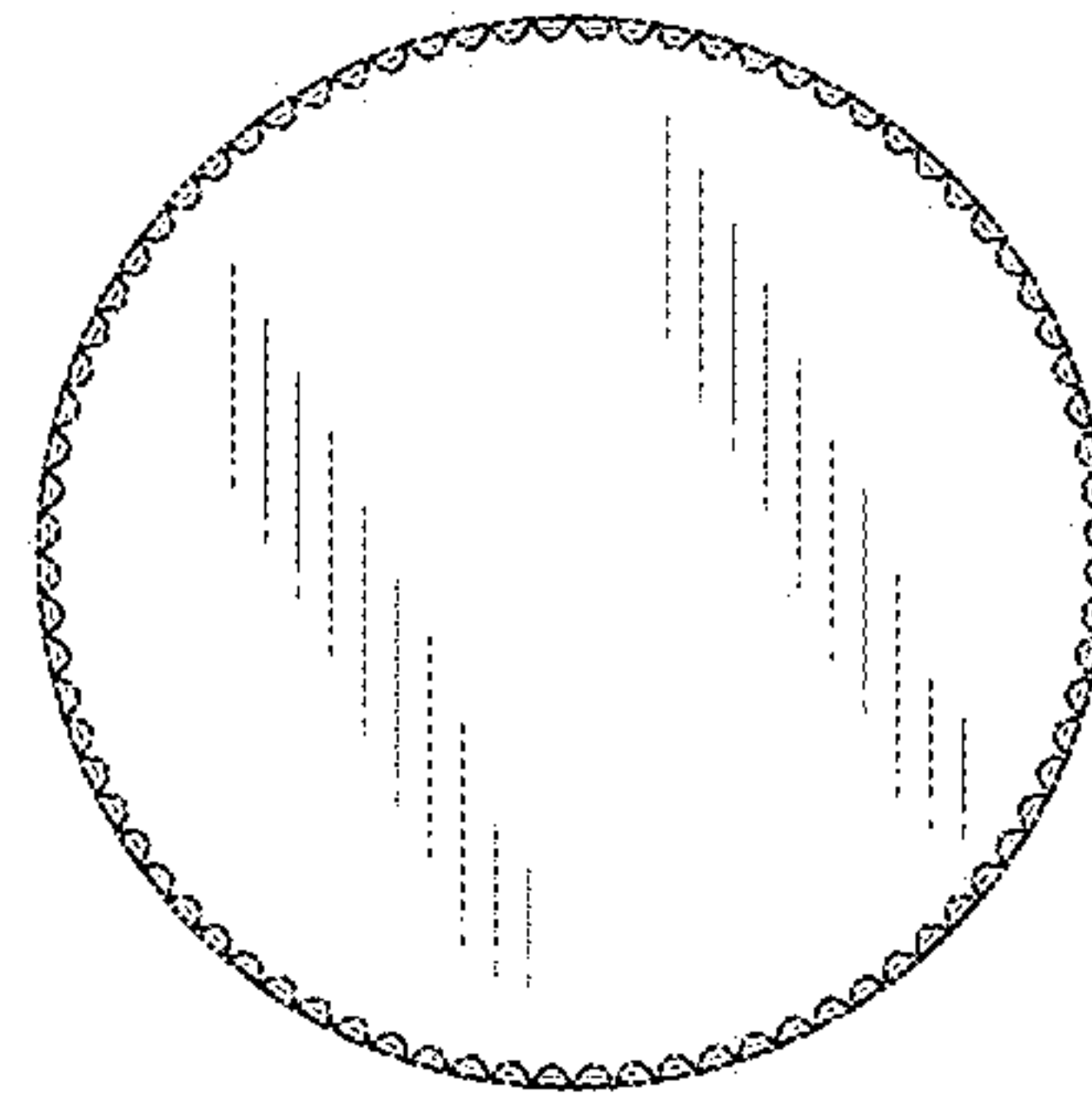

FIG.14

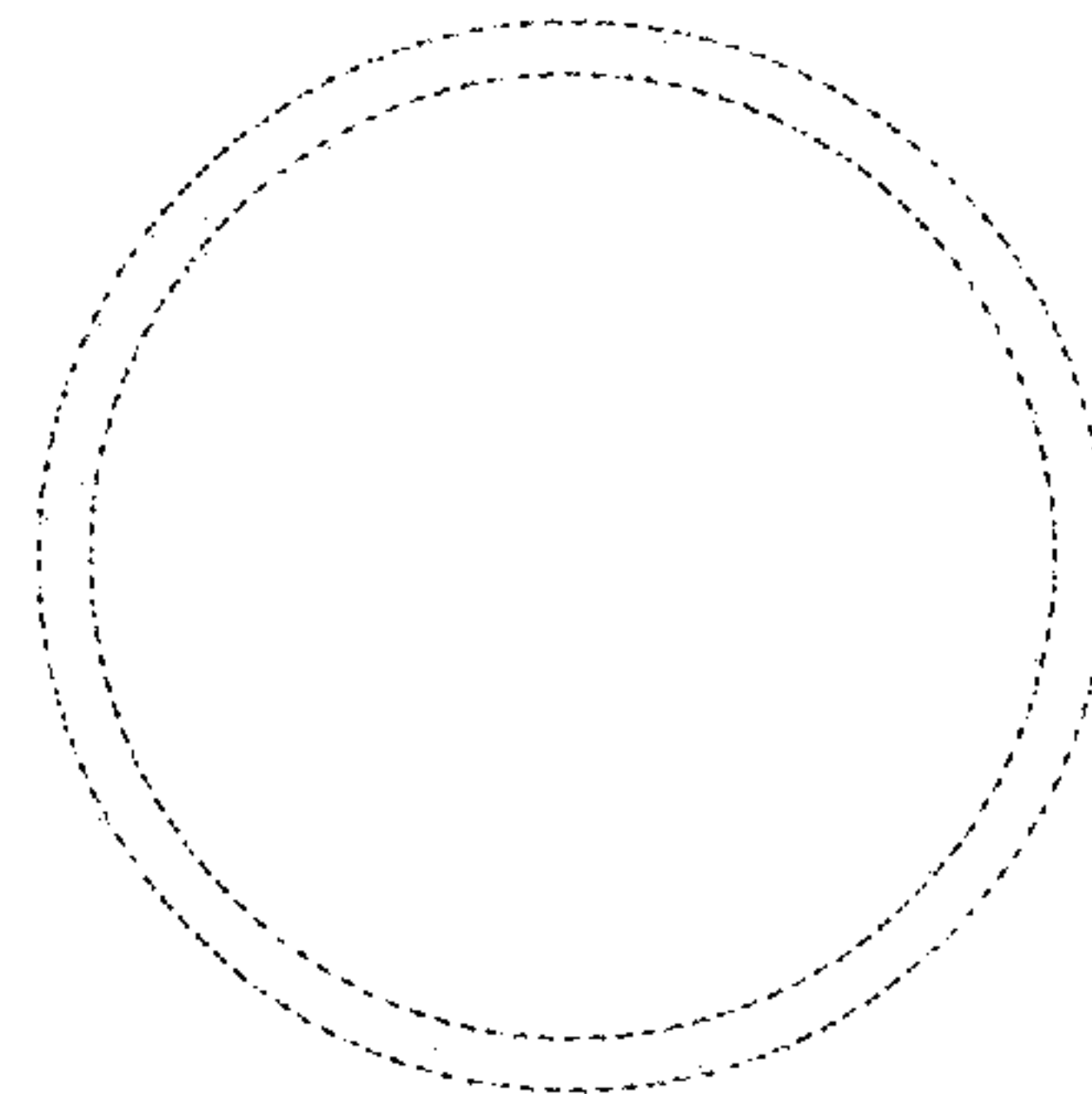

FIG.15

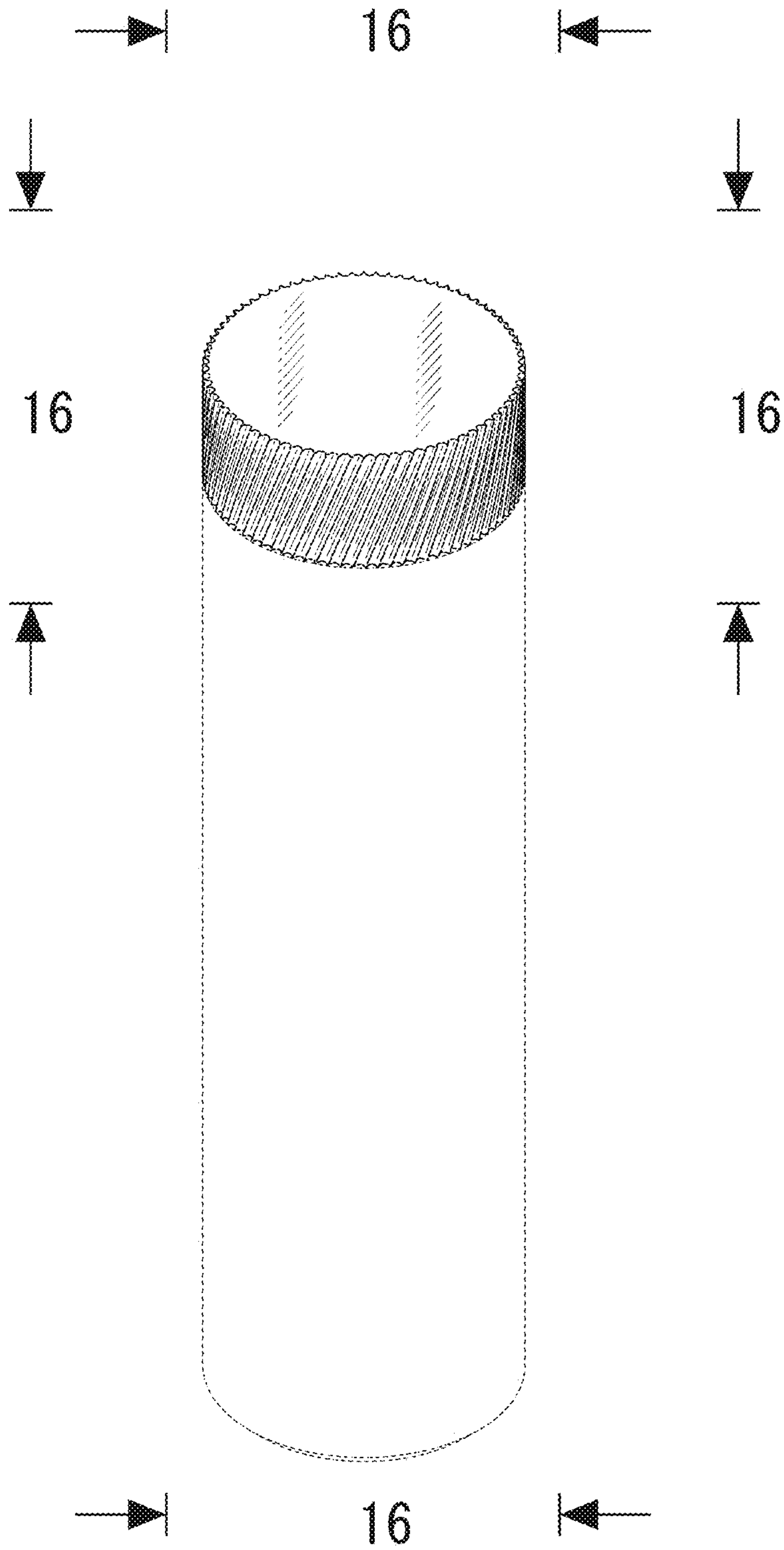

FIG.16

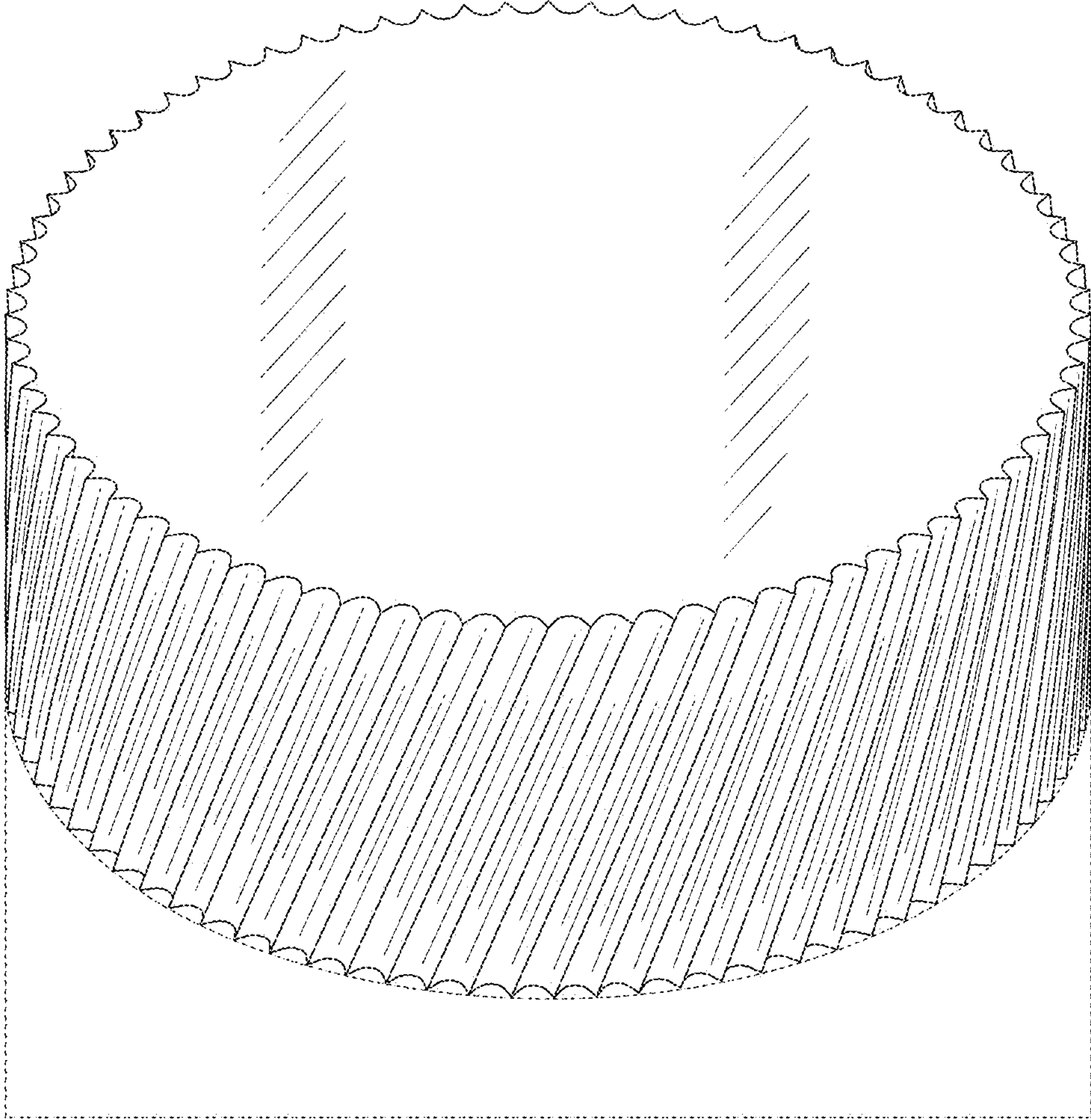

FIG.17

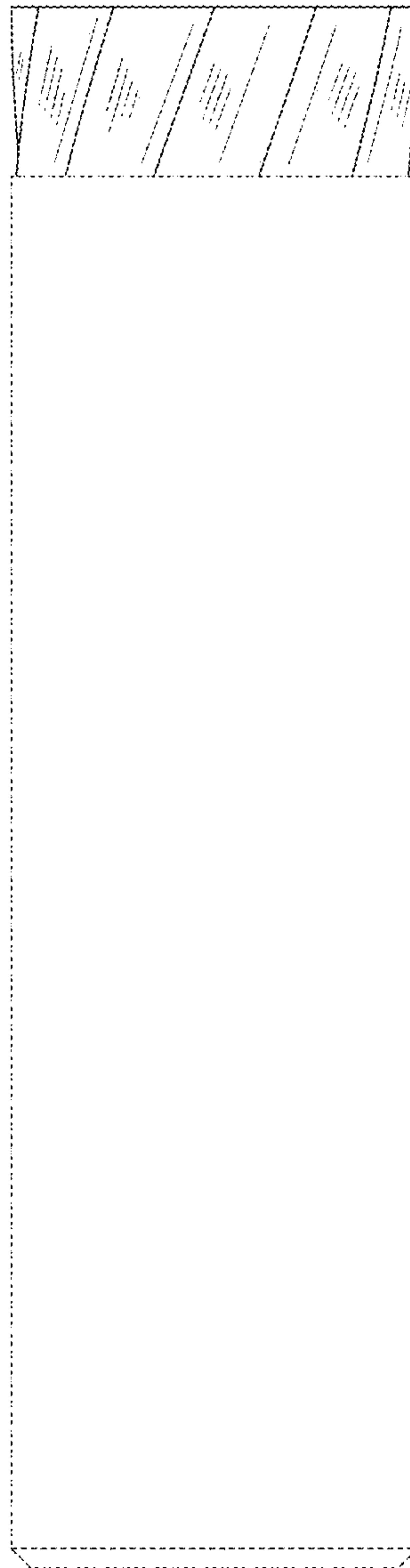

FIG. 18

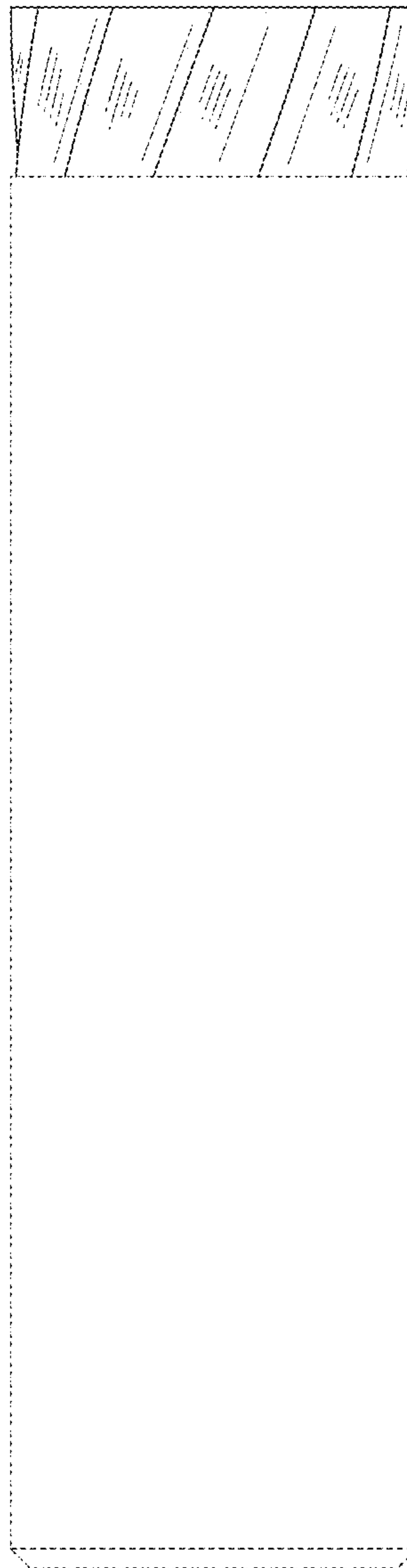

FIG.19



FIG.20

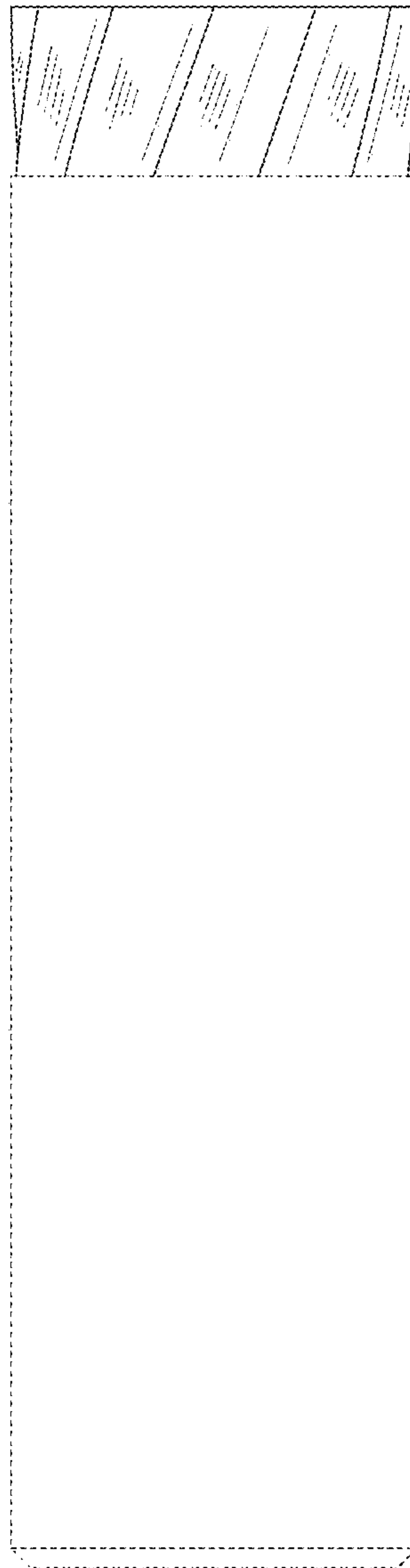

FIG.21

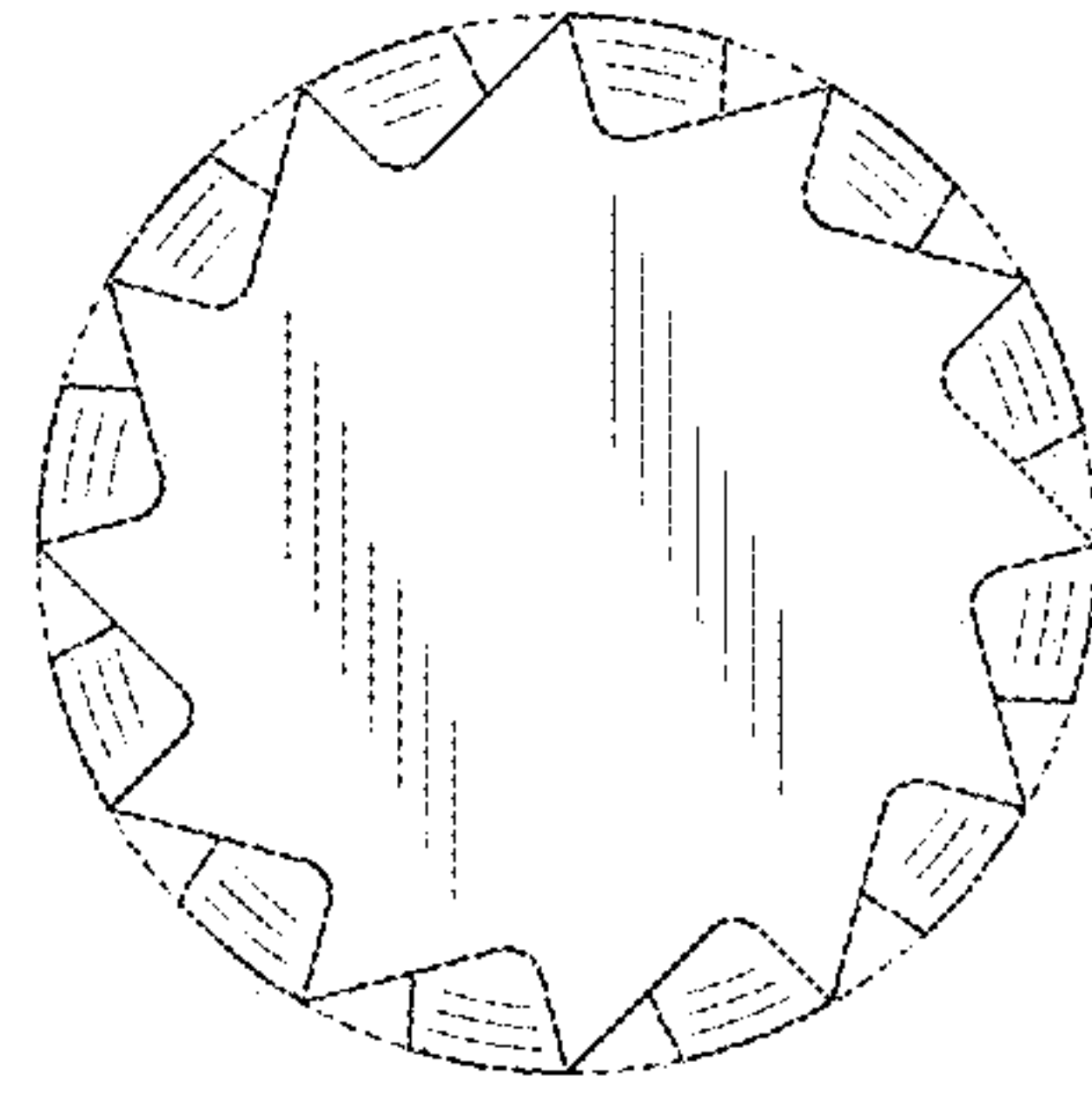

FIG.22

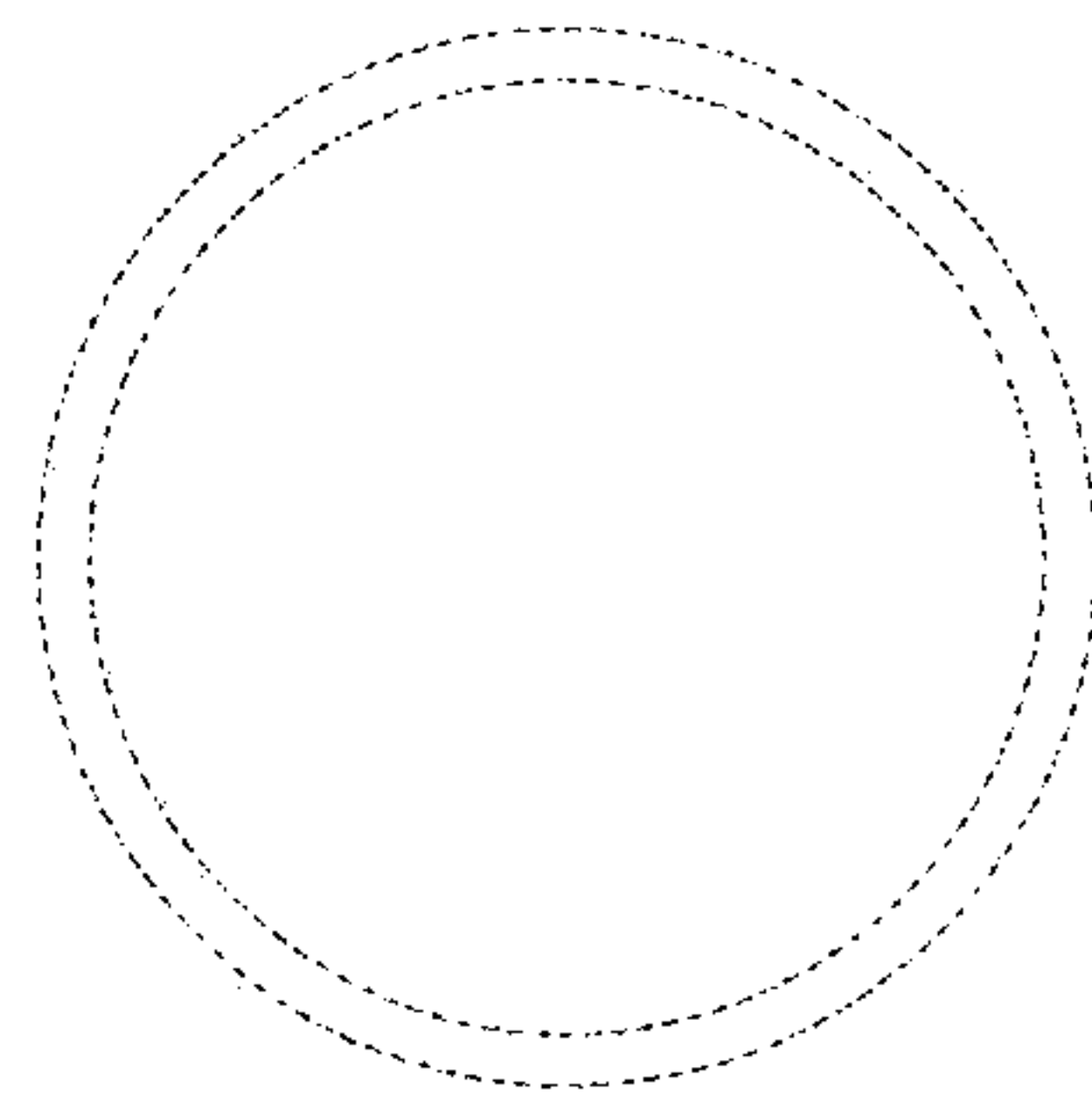

FIG.23

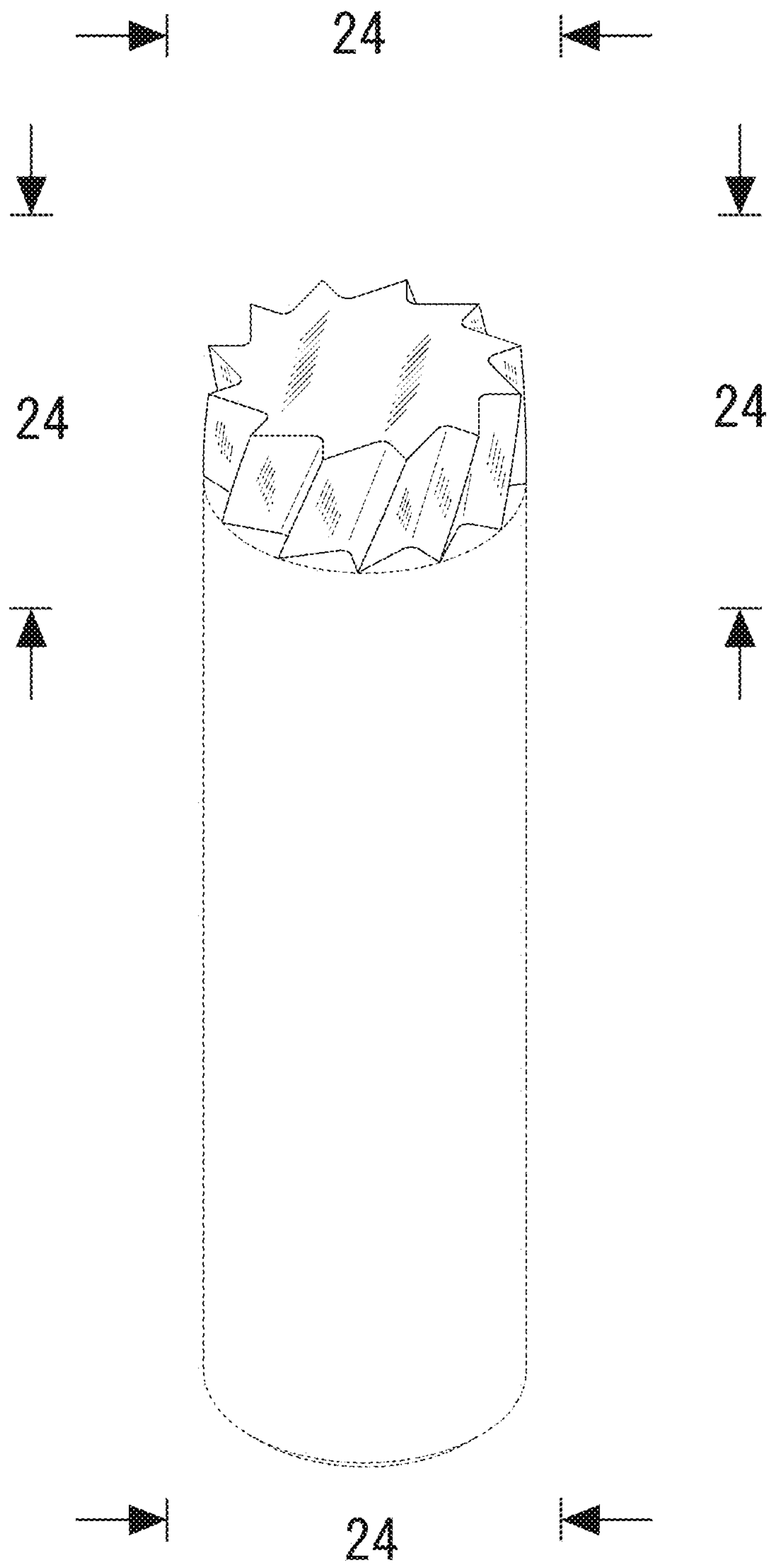

FIG.24

