



US00D980288S

(12) **United States Design Patent**  
**Liu**

(10) **Patent No.:** **US D980,288 S**  
(45) **Date of Patent:** **\*\* Mar. 7, 2023**

- (54) **WHALE AIR PUMP**
- (71) Applicant: **Wenming Liu, Yueyang (CN)**
- (72) Inventor: **Wenming Liu, Yueyang (CN)**
- (\*\*) Term: **15 Years**
- (21) Appl. No.: **29/804,265**
- (22) Filed: **Aug. 19, 2021**
- (51) **LOC (14) Cl.** ..... **15-02**
- (52) **U.S. Cl.**  
USPC ..... **D15/7**
- (58) **Field of Classification Search**  
USPC ..... D15/7-9; D21/584, 611  
CPC ..... F04B 53/14; F04B 53/92; F04B 33/00;  
F04B 33/005; F04B 1/005; F04D 13/06;  
F04D 29/22; F04D 29/046; F04D  
29/2266; F16K 11/048; F16K 15/20;  
F16K 31/602; A63H 23/10; A63H 3/06;  
A63H 3/26  
  
See application file for complete search history.

(56) **References Cited**

**U.S. PATENT DOCUMENTS**

- D147,629 S \* 10/1947 White ..... D21/599
- 2,611,996 A \* 9/1952 Garelick ..... A63H 23/10  
40/407
- D239,850 S \* 5/1976 Tong ..... D21/585
- D245,804 S \* 9/1977 Cone ..... D21/599
- 4,262,443 A \* 4/1981 Ferris ..... A63H 13/02  
446/289
- D292,603 S \* 11/1987 Shinn-Hsiung ..... D21/599
- D337,629 S \* 7/1993 Lal ..... D21/599
- D349,372 S \* 8/1994 Bird ..... D9/451
- D403,239 S \* 12/1998 Ying ..... D21/597
- D569,452 S \* 5/2008 Bruneel ..... D11/158
- D612,455 S \* 3/2010 Henderson ..... D21/597
- D619,843 S \* 7/2010 Noren et al.
- D670,771 S \* 11/2012 Lo ..... D21/597

- D749,857 S 2/2016 Krenkler
- D793,492 S 8/2017 Zanger et al.
- D839,923 S 2/2019 Hariri
- D865,267 S \* 10/2019 Hateley ..... D26/98
- D879,155 S 3/2020 Liu
- D900,253 S \* 10/2020 Deutsch ..... D21/599
- D900,941 S 11/2020 Wang
- D952,047 S \* 5/2022 Gao ..... D21/597
- D958,264 S \* 7/2022 Zheng ..... D21/597

**OTHER PUBLICATIONS**

IBase Toys, iBaseToy Sprinkler for Kids, Blue Whale Water Sprinkler, (site visited Jul. 26, 2022), Amazon.com, URL:<<https://www.amazon.com/iBaseToy-Sprinkler-Sprays-Toddlers-Outdoor/dp/B08X2GJGZR>> (Year: 2022).\*

(Continued)

*Primary Examiner* — Calvin E Vansant  
*Assistant Examiner* — Mark T. Philipps  
(74) *Attorney, Agent, or Firm* — Rumit Ranjit Kanakia

(57) **CLAIM**

The ornamental design for a whale air pump, as shown and described.

**DESCRIPTION**

FIG. 1 is a perspective view of a whale air pump showing my new design;  
FIG. 2 is a rear perspective view thereof;  
FIG. 3 is a front view thereof;  
FIG. 4 is a rear view thereof;  
FIG. 5 is a right side view thereof;  
FIG. 6 is a left side view thereof;  
FIG. 7 is a top view thereof; and,  
FIG. 8 is a bottom view thereof.  
The broken lines in the drawings depict portions of the whale air pump that form no part of the claimed design.

**1 Claim, 8 Drawing Sheets**

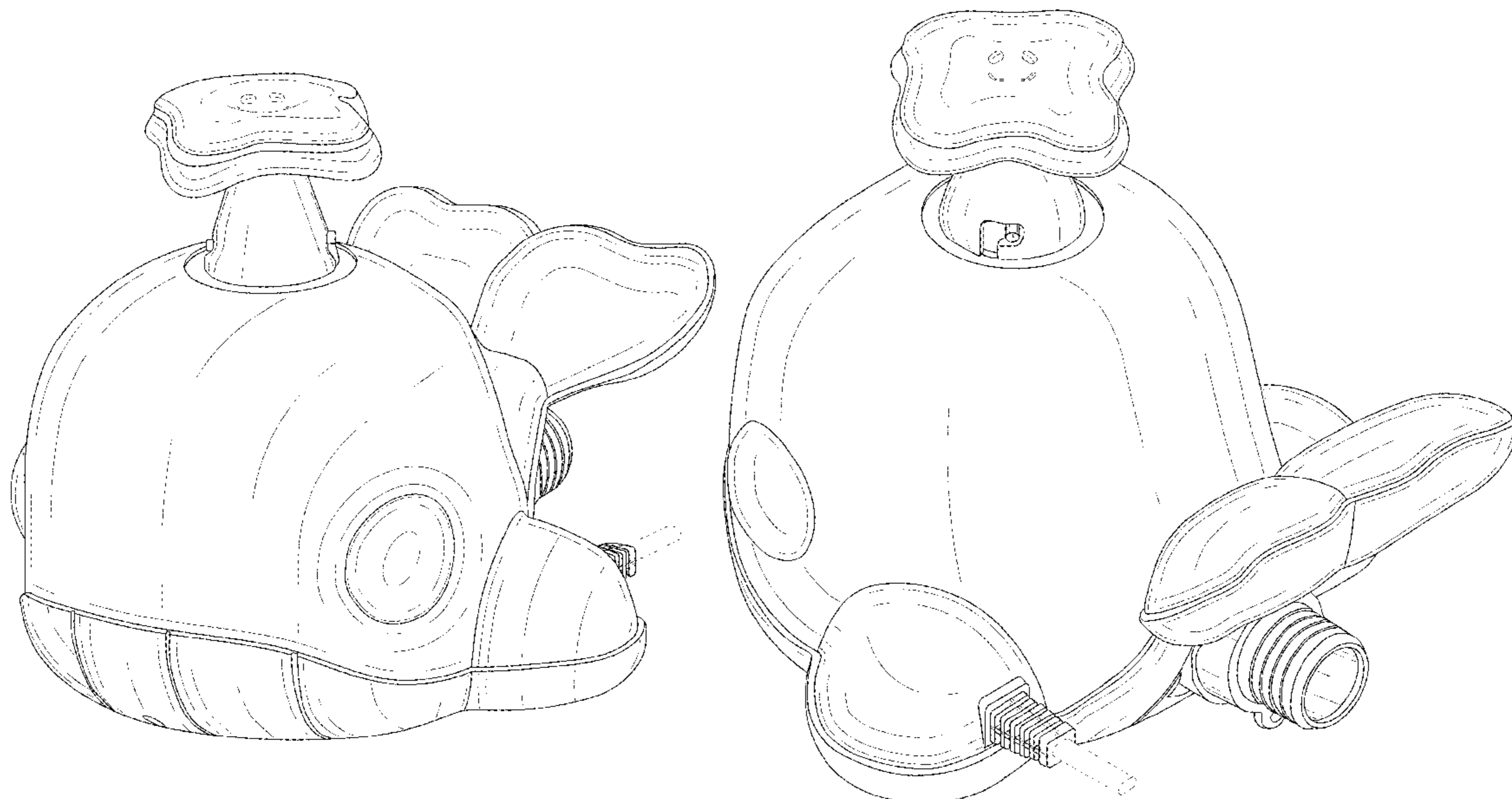

(56)

**References Cited**

OTHER PUBLICATIONS

Candyfouse, Whale Spray Swimming Pool Toy, (site visited Jul. 26, 2022), Amazon.com, URL:<<https://www.amazon.com/Swimming-Patterns-Waterproof-Design-Smooth/dp/B09LYRC7SS>> (Year: 2022).\*

Puzzled, Blue Whale Bath Buddy Squirter Blue 3 Inch, (site visited Jul. 26, 2022), Amazon.com, URL:<<https://www.amazon.com/Puzzled-Squirter-Adorable-Squirties-Interactive/dp/B00V2NN26S>> (Year: 2022).\*

\* cited by examiner

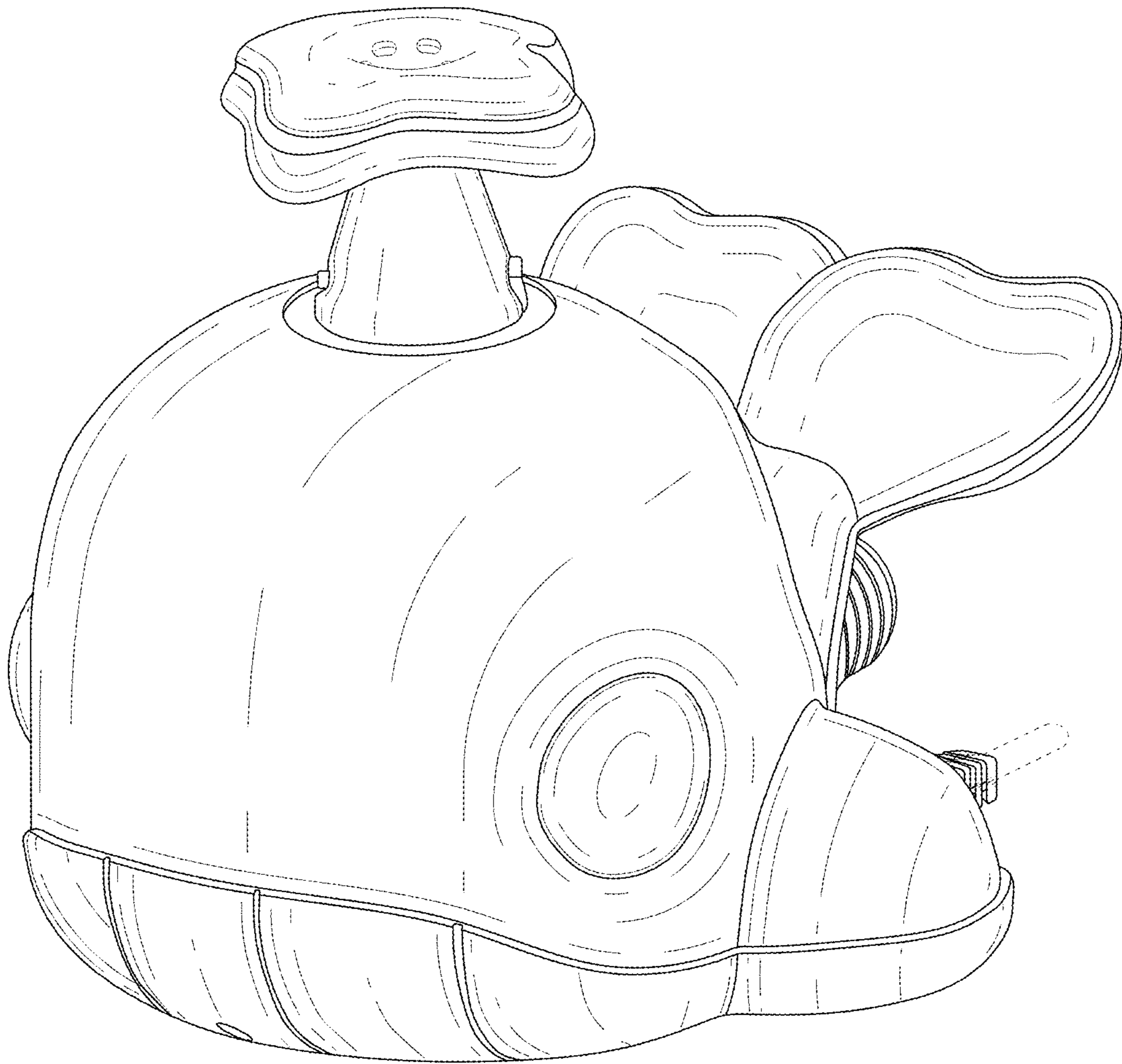

FIG. 1

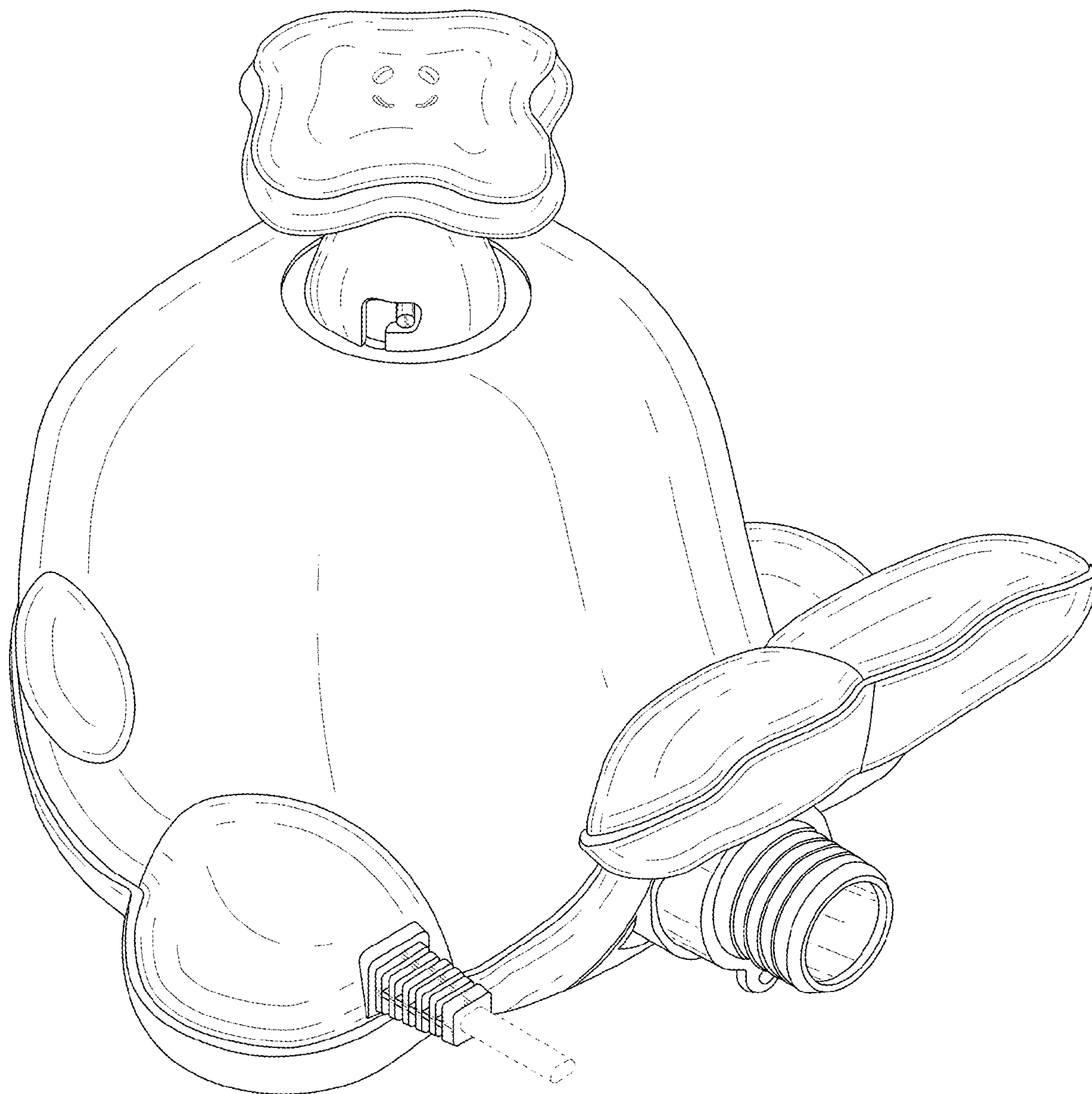

FIG. 2



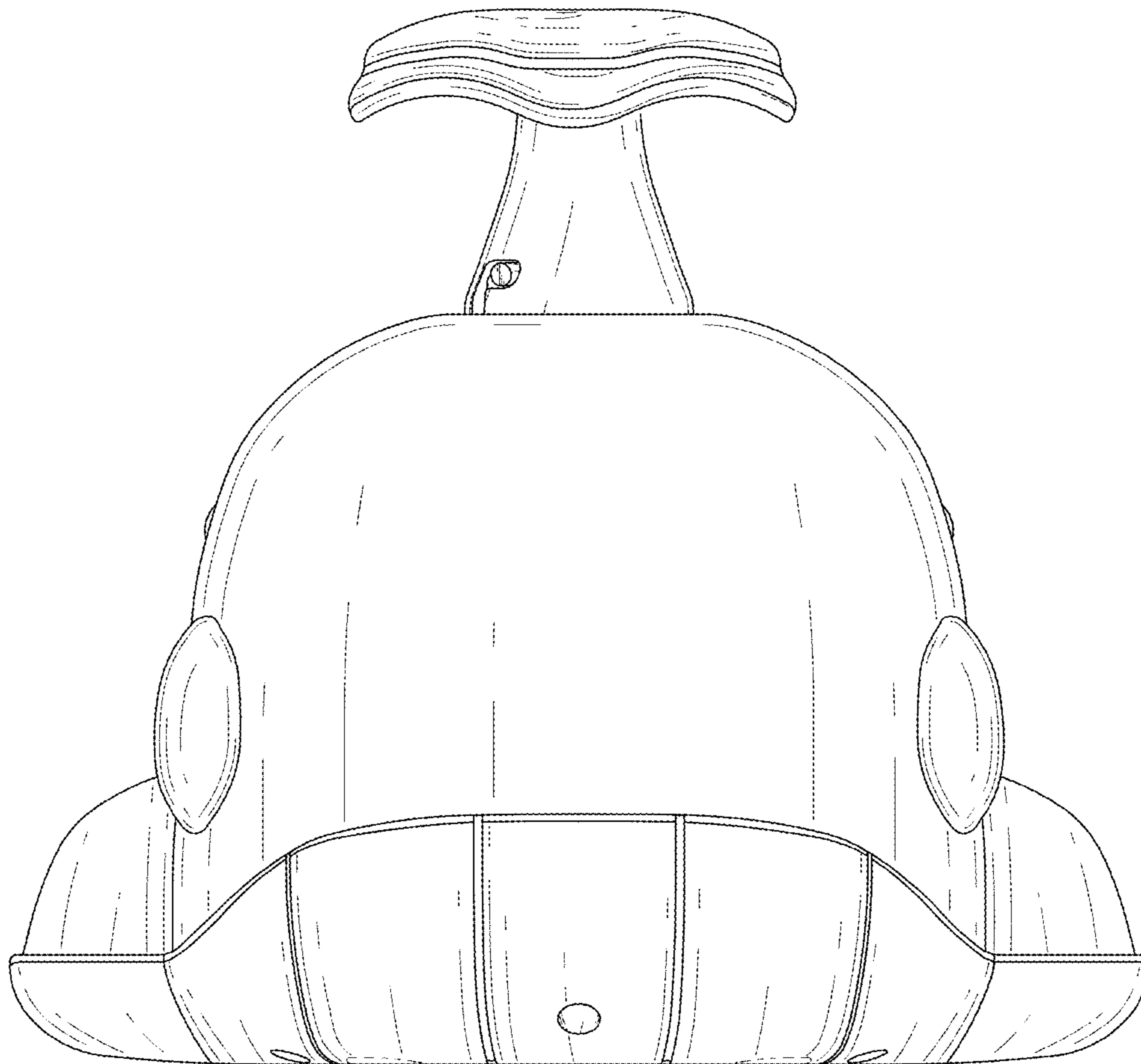

FIG. 3

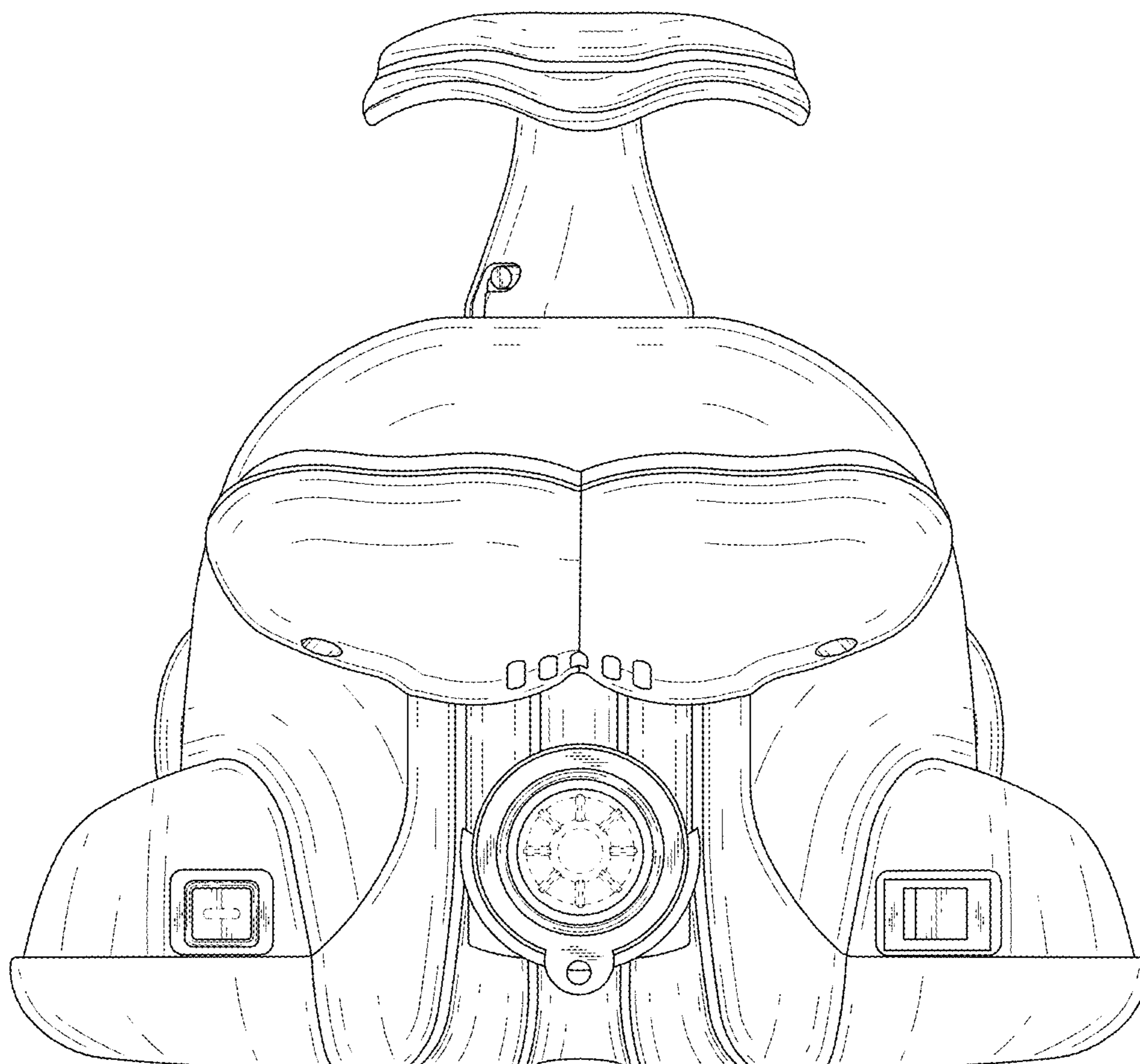

FIG. 4

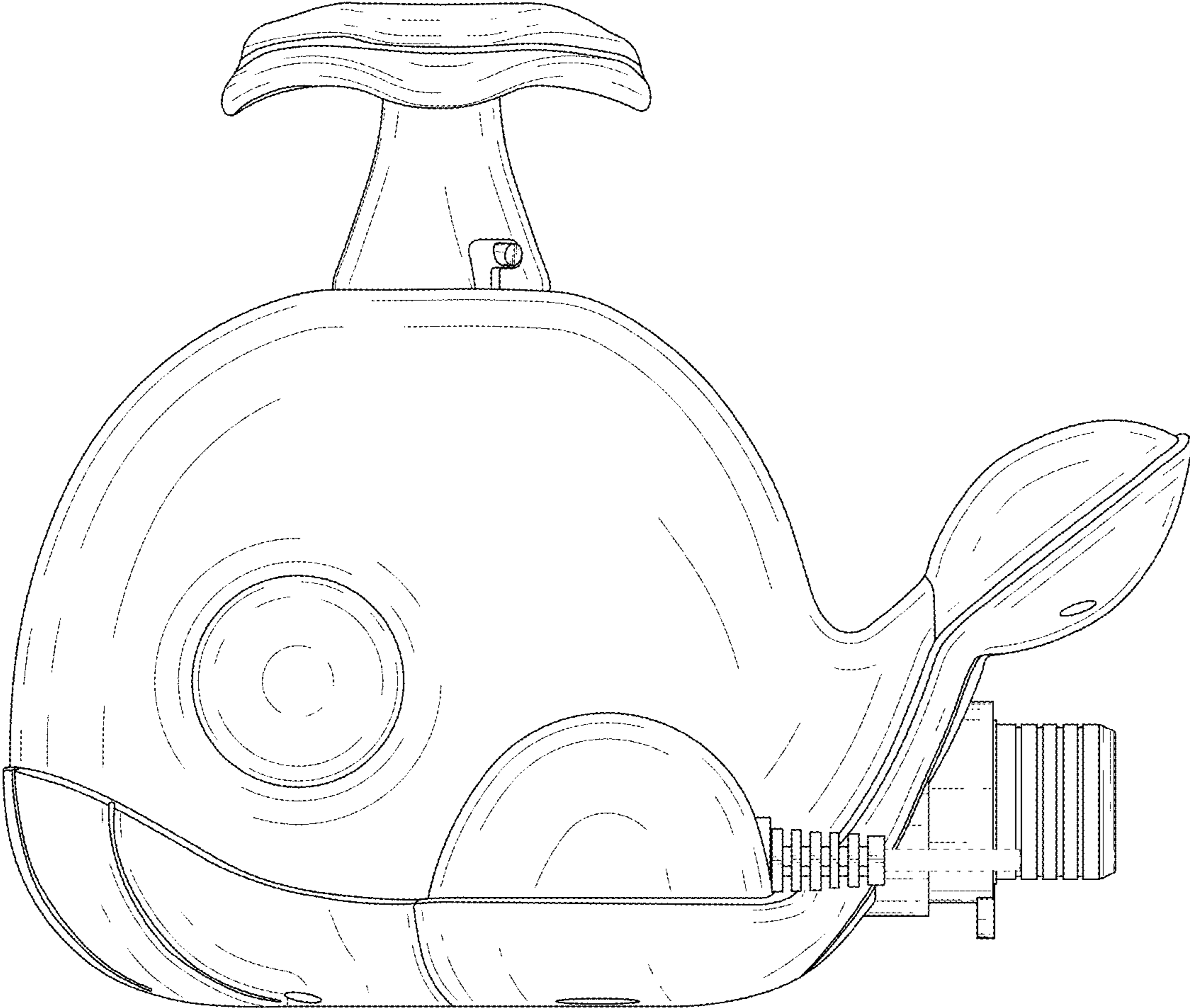

FIG. 5

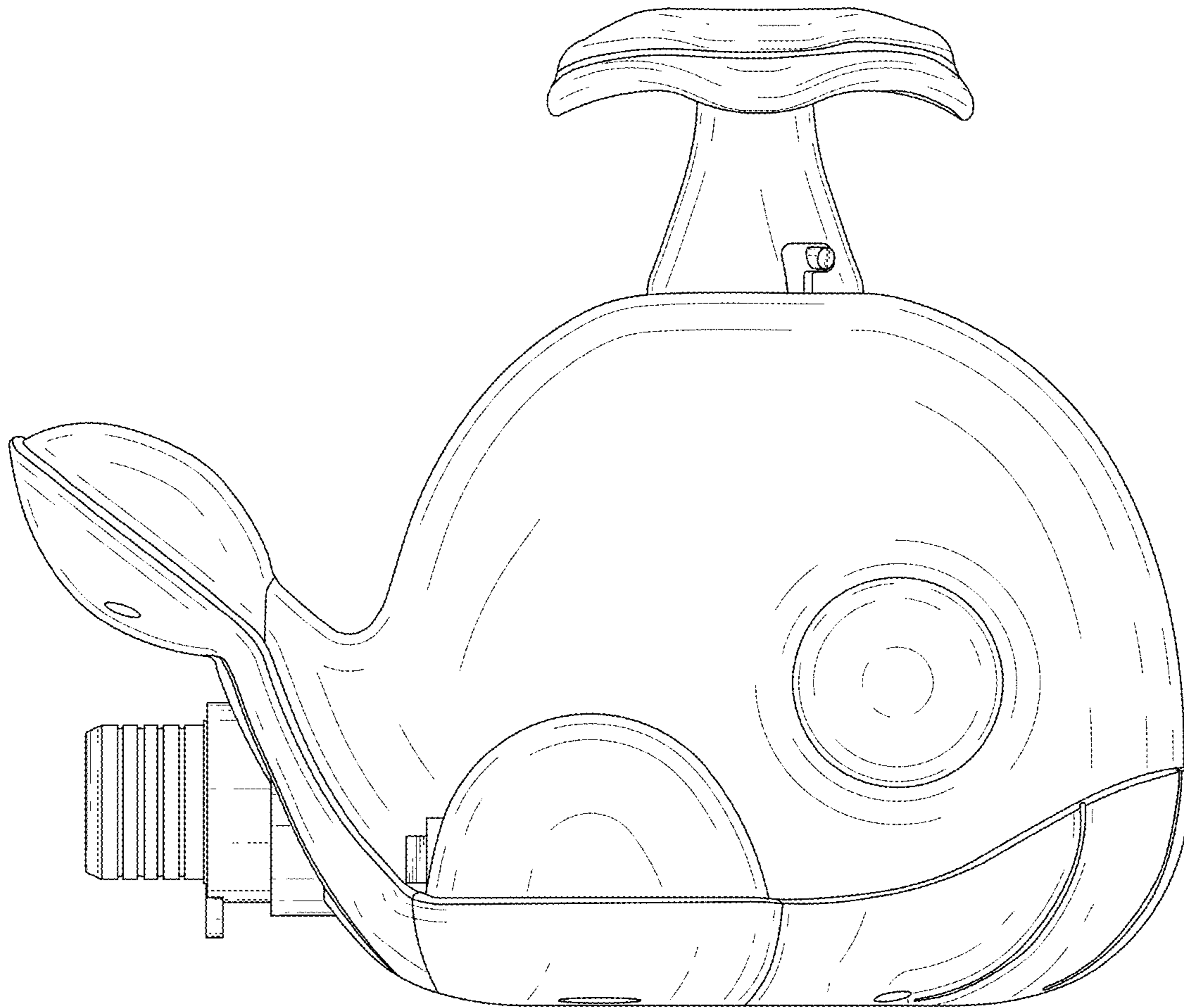

FIG. 6



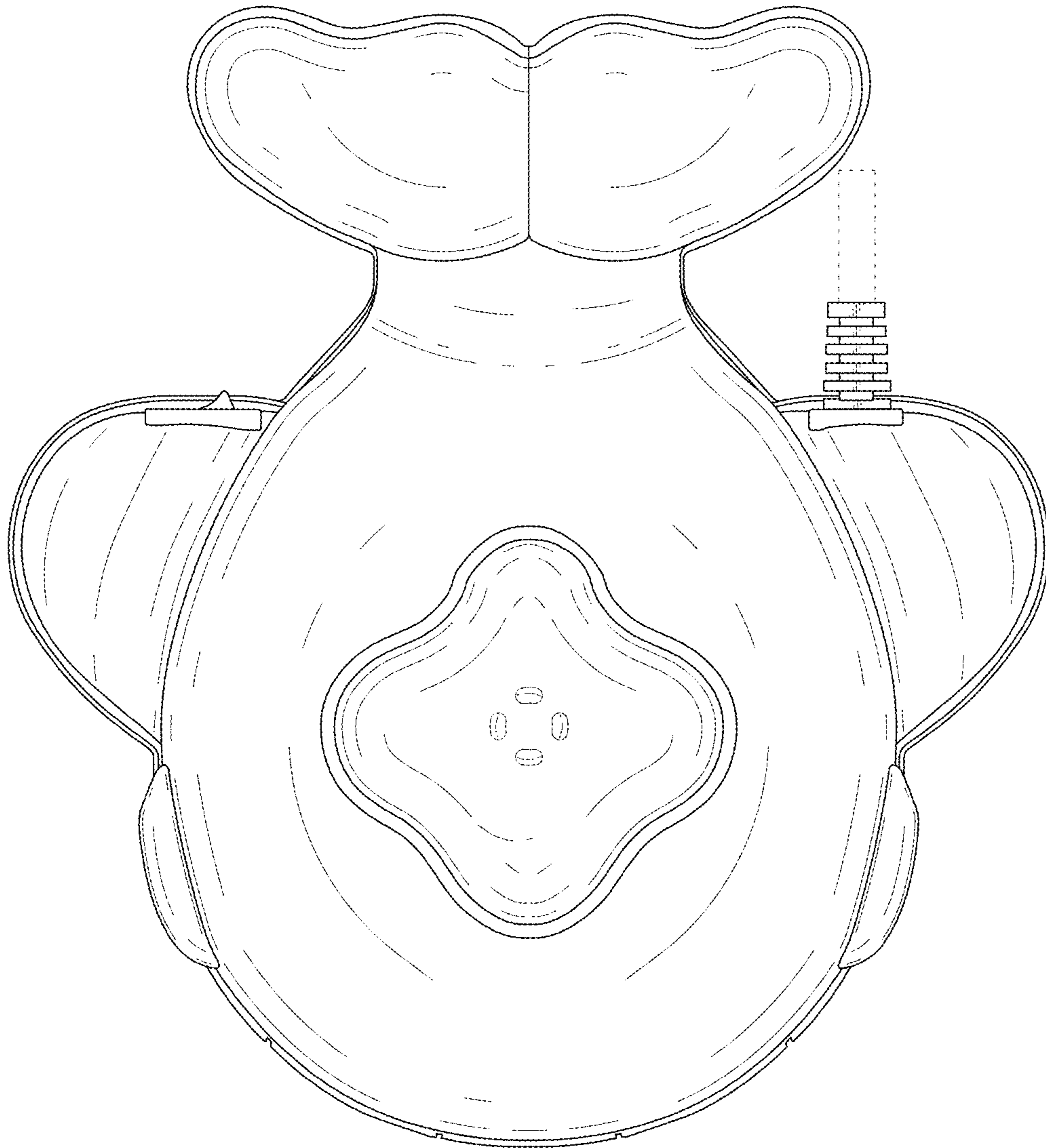

FIG. 7

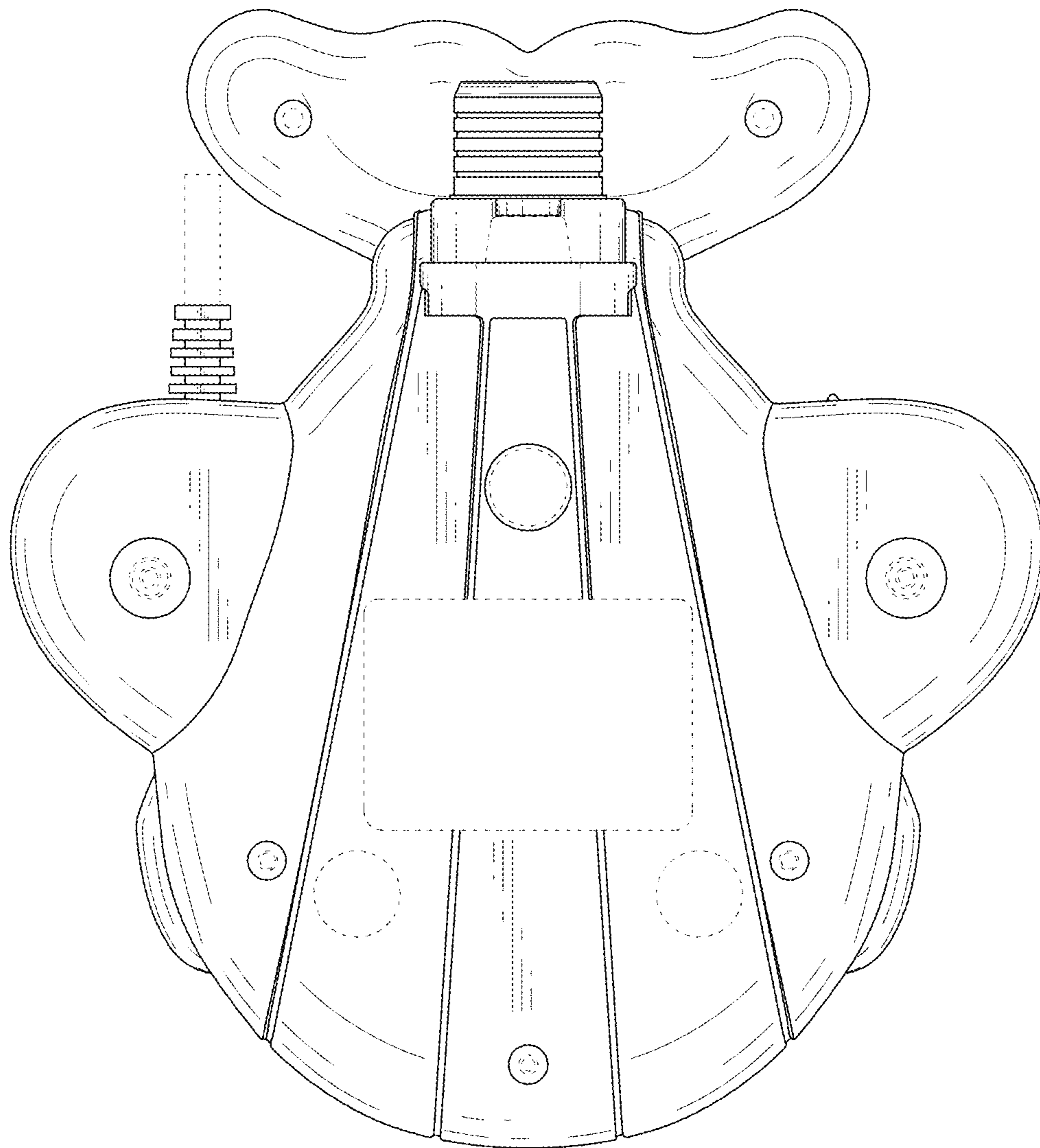

FIG. 8