



US00D980273S

(12) **United States Design Patent** (10) **Patent No.:** **US D980,273 S**  
**Sigmon et al.** (45) **Date of Patent:** **\*\* Mar. 7, 2023**

(54) **DISPLAY SCREEN OR PORTION THEREOF WITH ANIMATED GRAPHICAL USER INTERFACE**

(71) Applicant: **Dropbox, Inc.**, San Francisco, CA (US)

(72) Inventors: **Ian Sigmon**, Bloomfield Hills, MI (US); **John Hughes**, Birmingham, MI (US); **Jordan Scott**, Ferndale, MI (US); **Issey Roquet**, Toronto (CA)

(73) Assignee: **Dropbox, Inc.**, San Francisco, CA (US)

(\*\*) Term: **15 Years**

(21) Appl. No.: **29/803,580**

(22) Filed: **Aug. 13, 2021**

(51) **LOC (14) Cl.** ..... **14-04**

(52) **U.S. Cl.**  
USPC ..... **D14/488**

(58) **Field of Classification Search**  
USPC ..... **D14/485-95**

(Continued)

(56) **References Cited**

**U.S. PATENT DOCUMENTS**

D191,759 S \* 11/1961 Meyerson ..... D11/12

D644,662 S \* 9/2011 Gardner ..... D14/491

(Continued)

**OTHER PUBLICATIONS**

Arrow, Arrowhead icon—Ahasoft, [https://www.iconfinder.com/icons/1051139/arrow\\_arrowhead\\_forward\\_move\\_shift\\_up\\_triple\\_upload\\_icon](https://www.iconfinder.com/icons/1051139/arrow_arrowhead_forward_move_shift_up_triple_upload_icon) (Year: 2016).\*

(Continued)

*Primary Examiner* — Melanie H Tung  
*Assistant Examiner* — Darmawan Truong

(74) *Attorney, Agent, or Firm* — Sterne, Kessler, Goldstein & Fox P.L.L.C.

(57) **CLAIM**

The ornamental design for a display screen or portion thereof with animated graphical user interface, as shown and described.

**DESCRIPTION**

The file of this patent contains at least one drawing/photograph executed in color. Copies of this patent with color drawing(s)/photograph(s) will be provided by the Office upon request and payment of the necessary fee.

FIG. 1 is a front view of a display screen or portion thereof with animated graphical user interface showing a first image of the claimed design;

FIG. 2 is a second image thereof;

FIG. 3 is a third image thereof;

FIG. 4 is a fourth image thereof;

FIG. 5 is a fifth image thereof;

FIG. 6 is a sixth image thereof;

FIG. 7 is a seventh image thereof;

FIG. 8 is an eighth image thereof;

FIG. 9 is a second embodiment of a display screen or portion thereof with animated graphical user interface showing a first image of the claimed design;

FIG. 10 is a second image thereof;

FIG. 11 is a third image thereof;

FIG. 12 is a fourth image thereof;

FIG. 13 is a fifth image thereof;

FIG. 14 is a sixth image thereof;

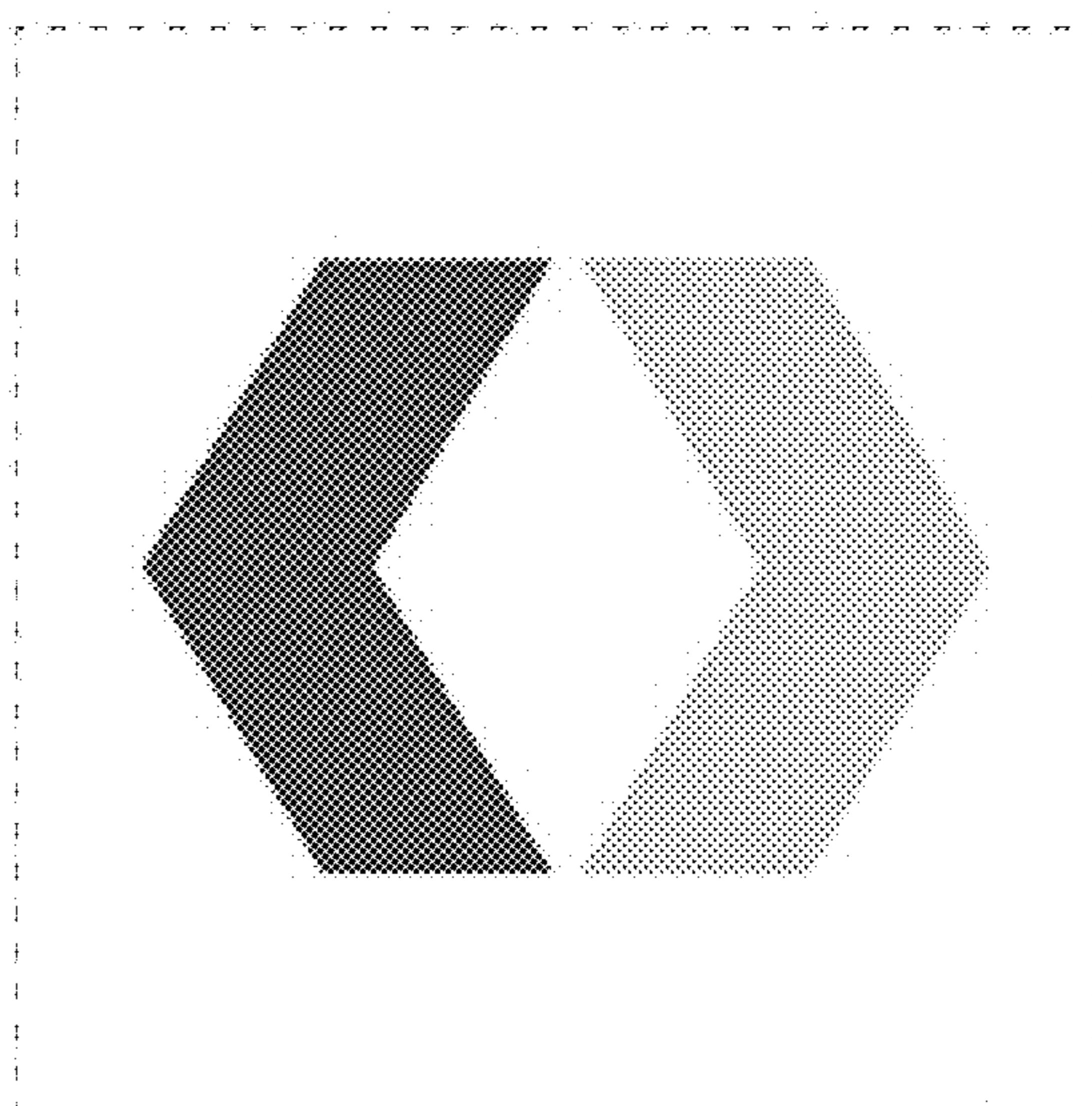
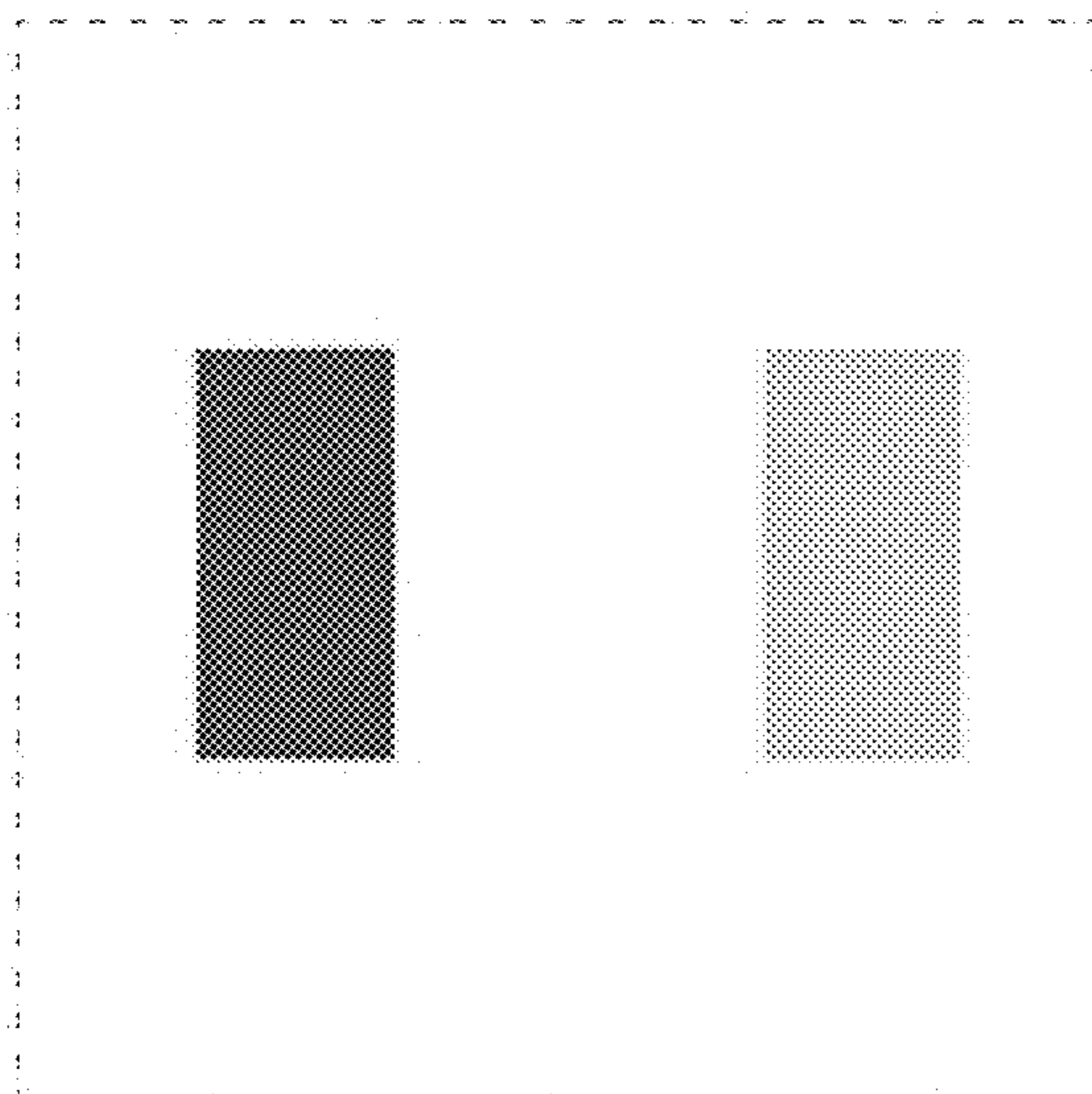
FIG. 15 is a seventh image thereof; and,

FIG. 16 is an eighth image thereof.

The broken lines in the figures show a display screen or portion thereof, and form no part of the claimed design.

The appearance of the animated image sequentially transitions between the images shown in FIGS. 1-8 and FIGS. 9-16. The process or period in which one image transitions to another forms no part of the claimed design.

**1 Claim, 16 Drawing Sheets**  
**(8 of 16 Drawing Sheet(s) Filed in Color)**



(58) **Field of Classification Search**

CPC .... G06F 3/048; G06F 3/0481; G06F 3/04812;  
G06F 3/04815; G06F 3/04817; G06F  
3/0482; G06F 3/0483; G06F 3/0484;  
G06F 3/04842; G06F 3/04845; G06F  
3/04847; G06F 3/0485; G06F 3/0486;  
G06F 3/0487; G06F 3/0488; G06F  
3/04883; G06F 3/04886

See application file for complete search history.

D836,661 S \* 12/2018 Sakata ..... D14/491  
D868,106 S \* 11/2019 Imaishi ..... D14/491  
D887,442 S \* 6/2020 Sakata ..... D14/489  
D891,465 S \* 7/2020 Inman ..... D14/491  
D922,430 S \* 6/2021 Kataoka ..... D14/491  
2017/0139568 A1 \* 5/2017 Itani ..... G06F 3/04812  
2017/0203685 A1 \* 7/2017 Hirai ..... B60Q 1/50  
2017/0259734 A1 \* 9/2017 Imaishi ..... B60Q 1/444  
2019/0023281 A1 \* 1/2019 Fukutaka ..... B60W 30/12  
2020/0070716 A1 \* 3/2020 Sakata ..... B60Q 1/324

(56)

**References Cited**

U.S. PATENT DOCUMENTS

D698,819 S \* 2/2014 Gardner ..... D14/491  
D703,689 S \* 4/2014 Kim ..... D14/486  
D709,521 S \* 7/2014 Choi ..... D14/491  
D712,921 S \* 9/2014 Pearson ..... D14/488  
D746,324 S \* 12/2015 Kim ..... D14/489  
D753,176 S \* 4/2016 Barbato ..... D14/488  
D758,416 S \* 6/2016 Cho ..... D14/487  
D761,310 S \* 7/2016 Brinda ..... D14/491  
D763,884 S \* 8/2016 Lee ..... D14/486  
D806,121 S \* 12/2017 Jewitt ..... D14/491

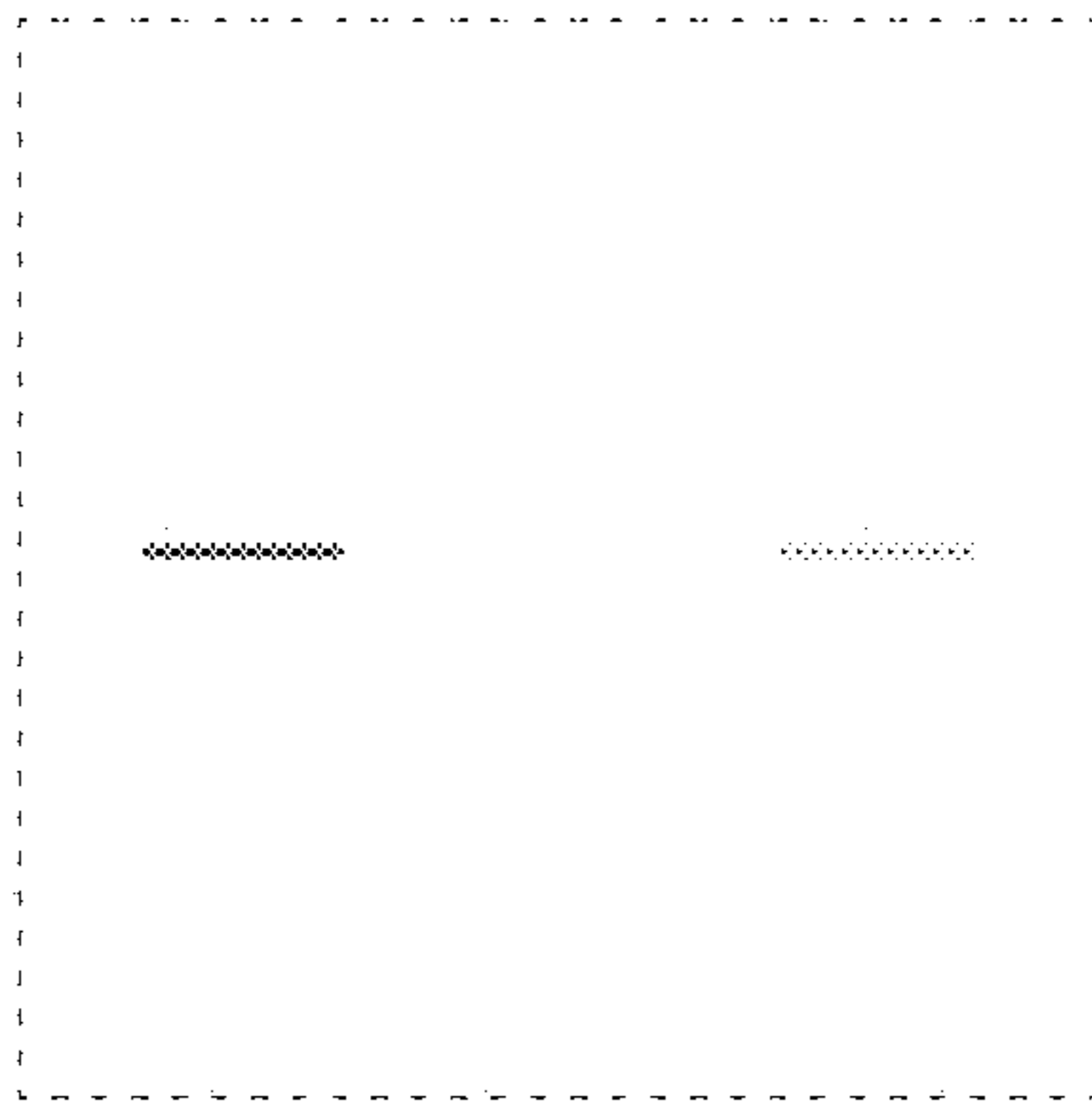
OTHER PUBLICATIONS

Chevron Icon Trendy Flat Vector—tvectoricons, <https://depositphotos.com/238040948/stock-illustration-chevron-icon-trendy-flat-vector.html> (Year: 2019).\*

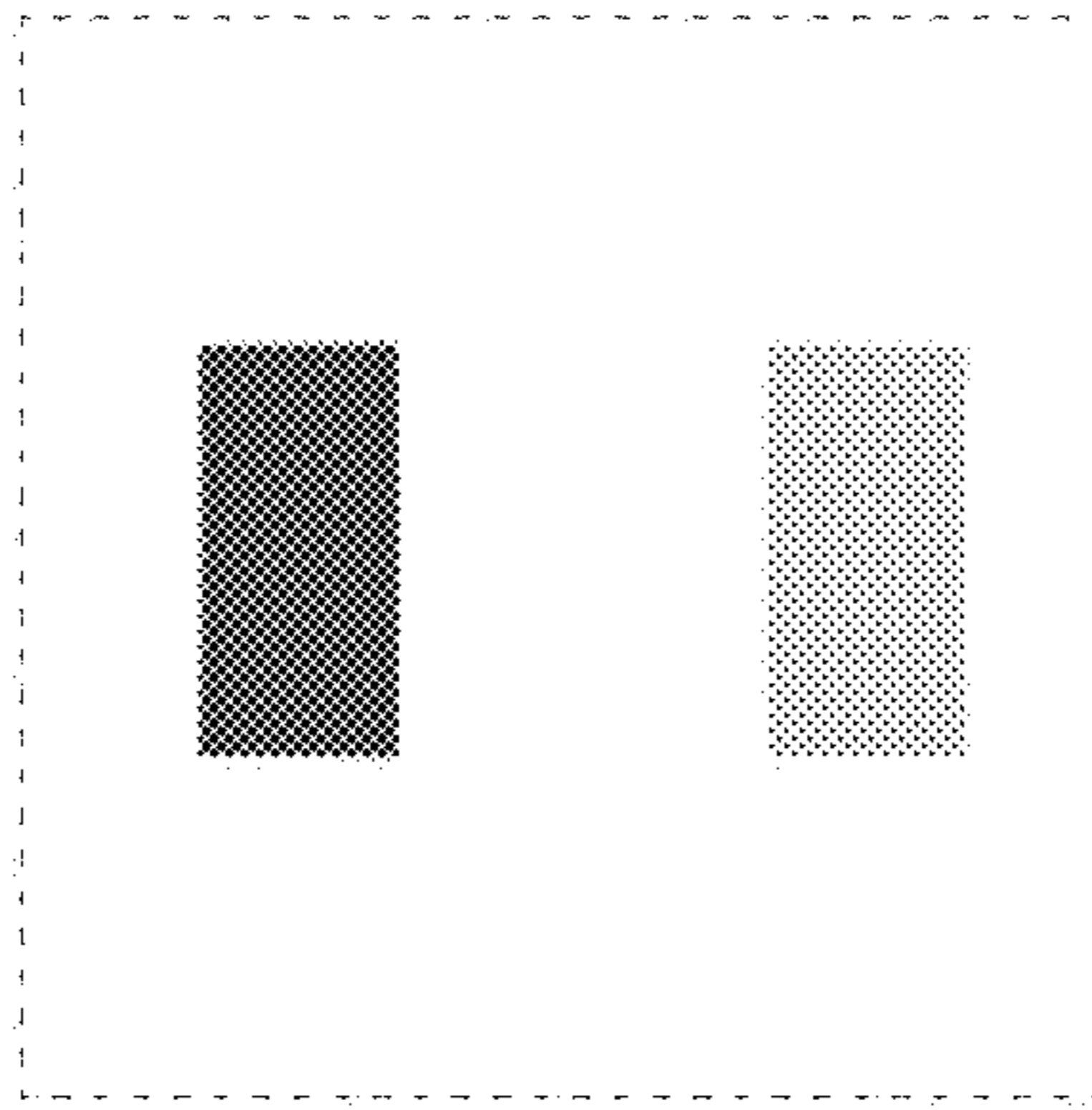
Set Of Black Vector Arrows—iStock, <https://www.istockphoto.com/vector/set-of-black-vector-arrows-arrow-icon-arrows-vector-collection-vector-gm1141898953-306105306> (Year: 2019).\*

Three Arrows To The Right Icon—iStock, <https://www.istockphoto.com/vector/three-arrows-to-the-right-icon-simple-glyph-flat-vector-of-arrows-icons-for-ui-and-gm1180987603-331052432> (Year: 2019).\*

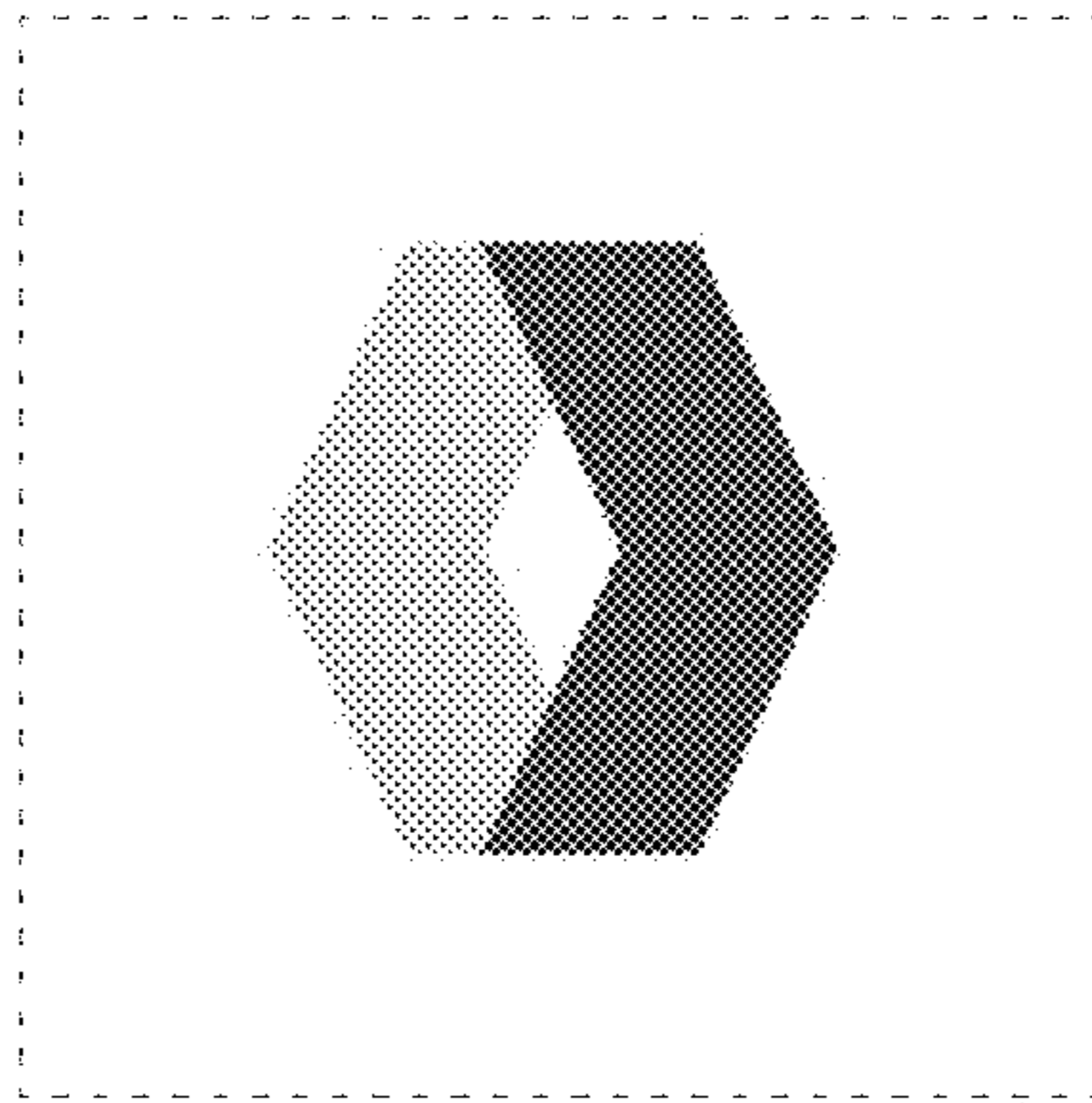
\* cited by examiner



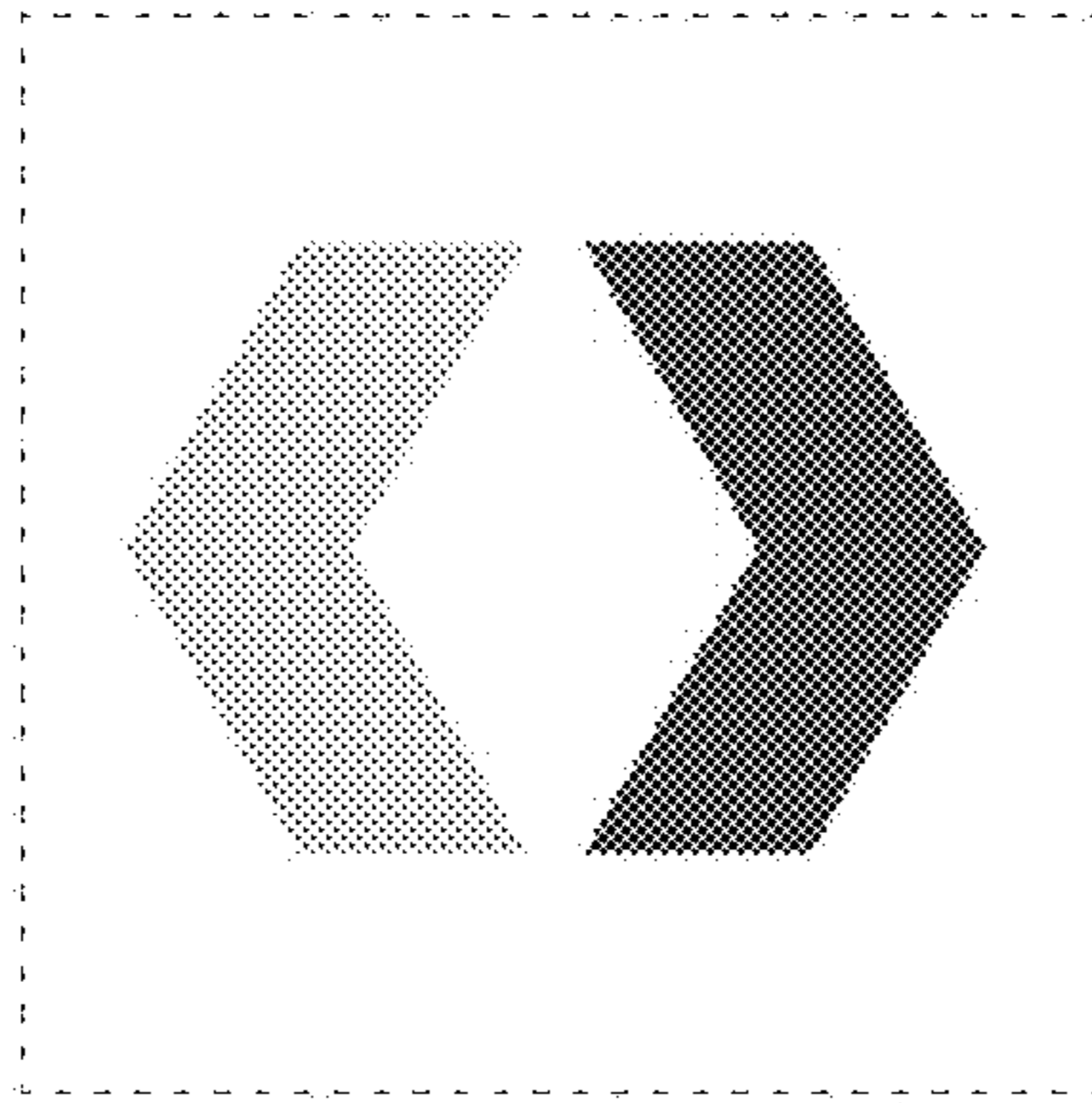
**FIG. 1**



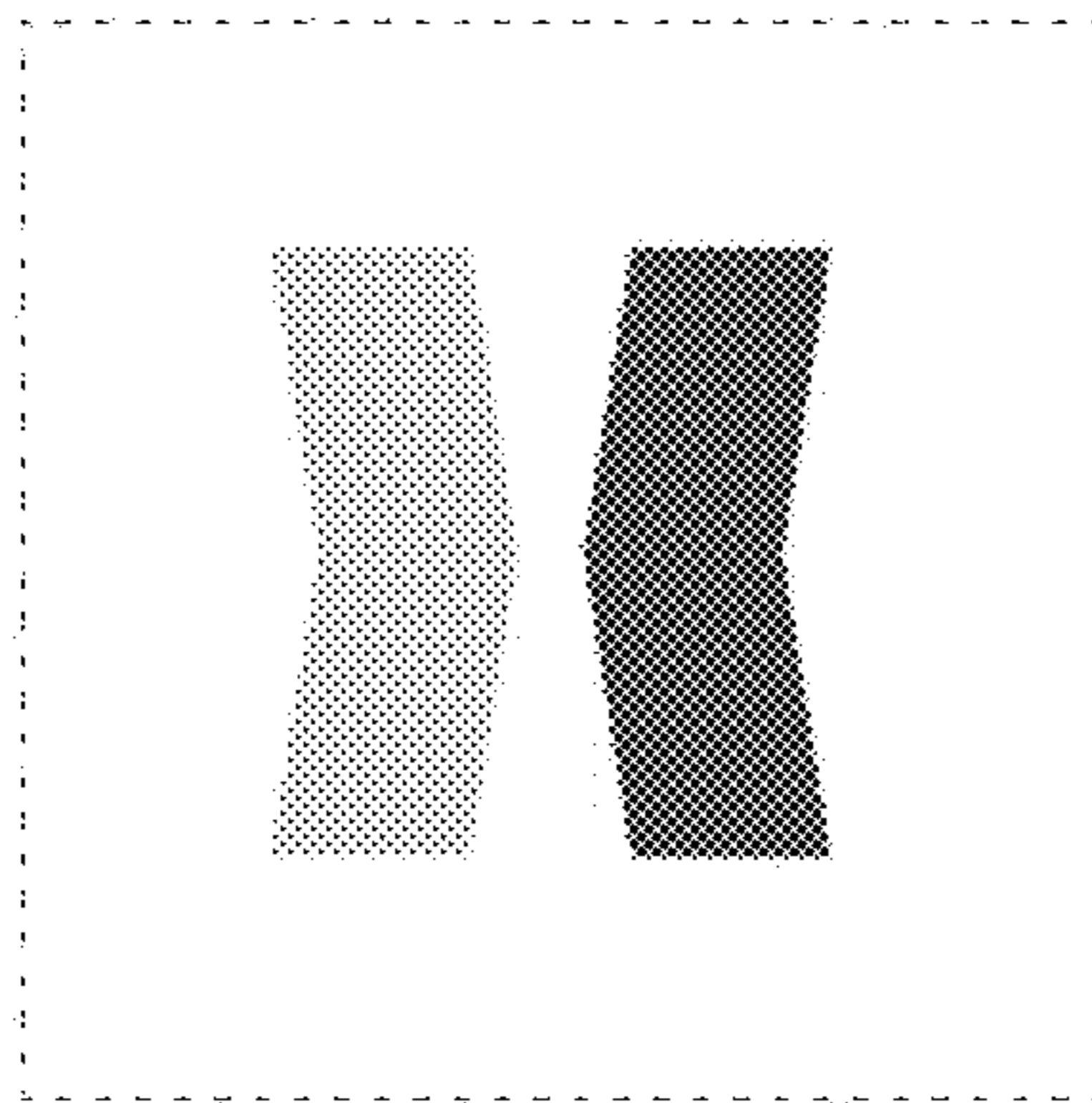
**FIG. 2**



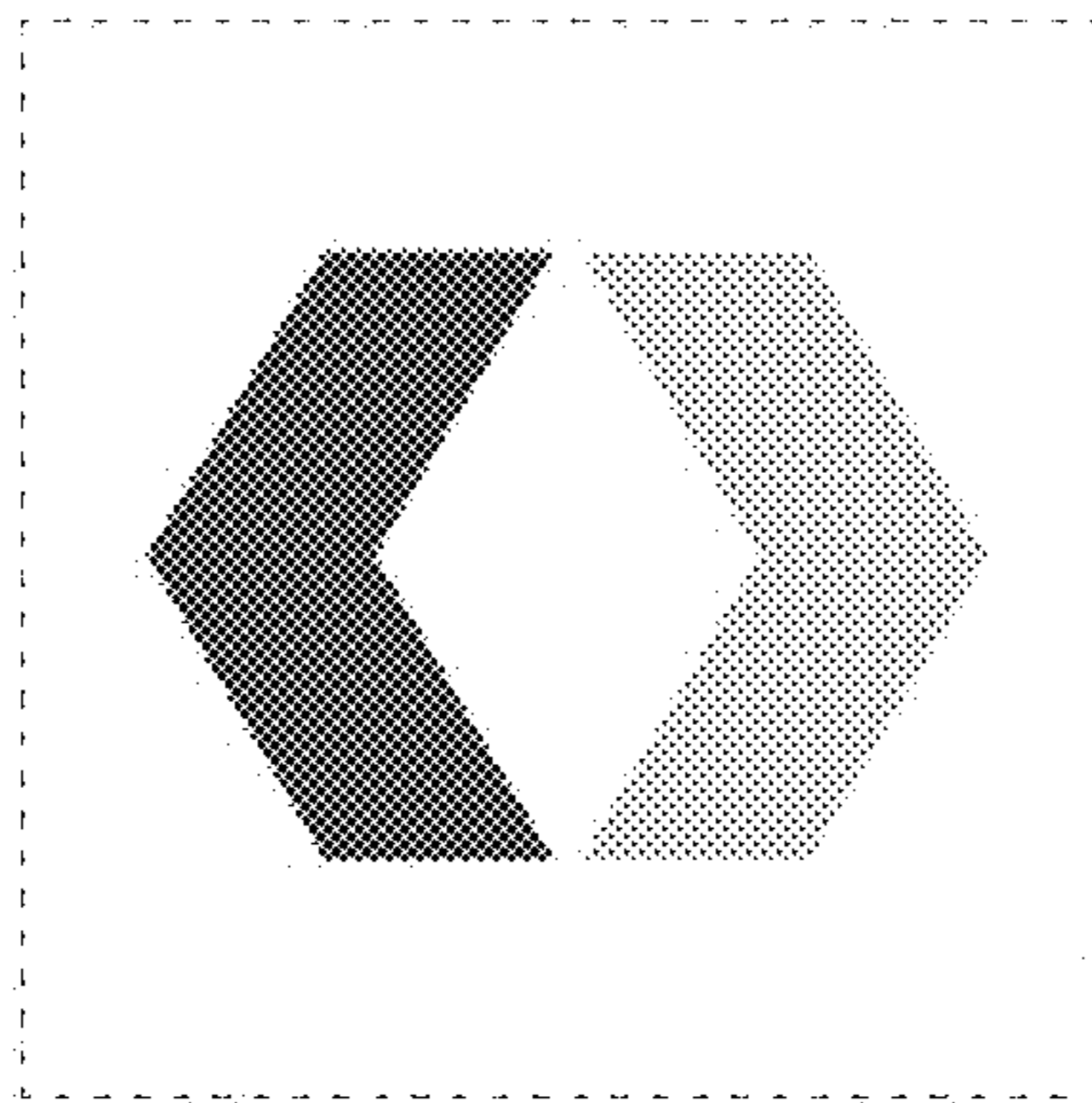
**FIG. 3**



**FIG. 4**

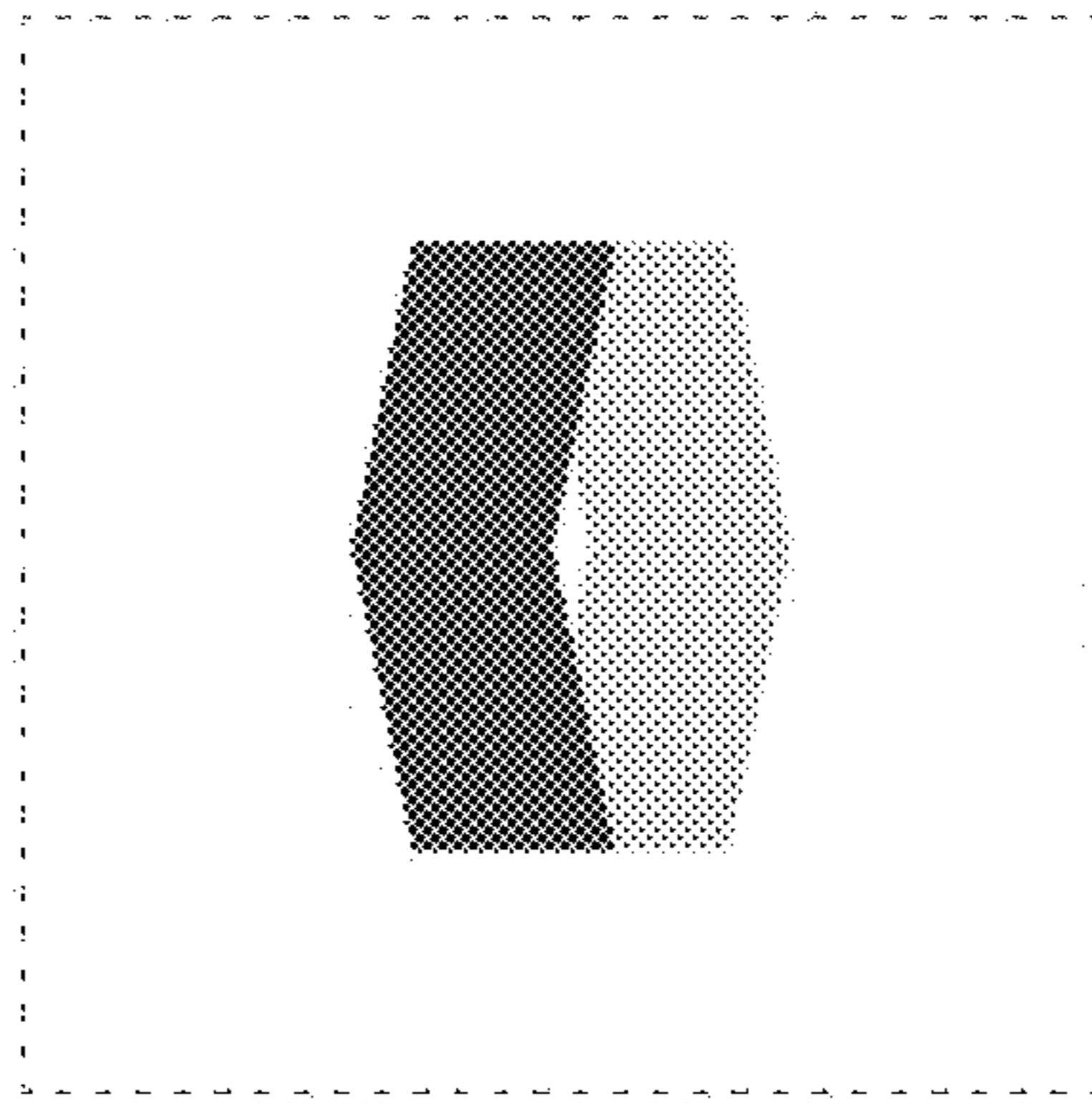


**FIG. 5**

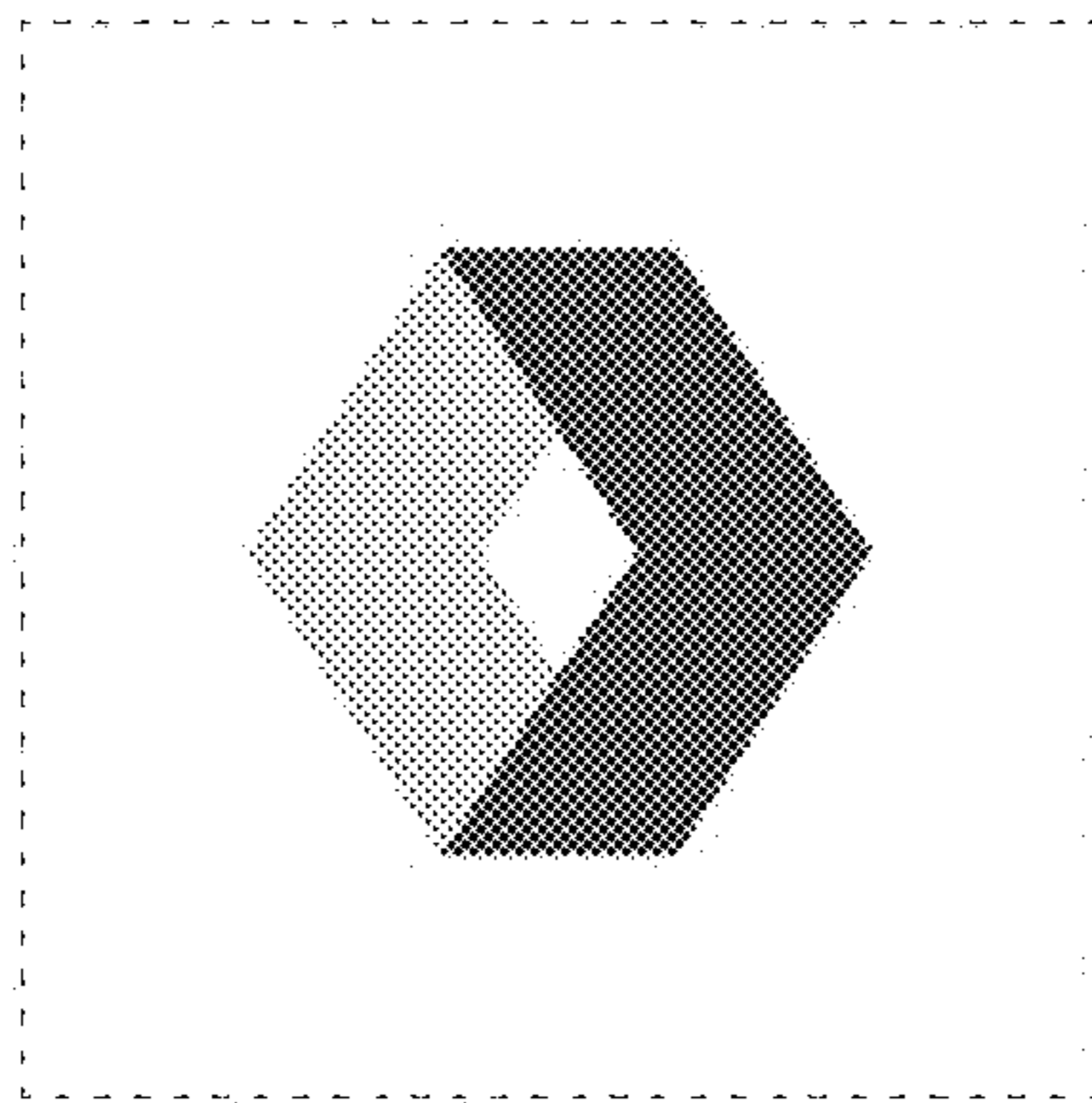


**FIG. 6**

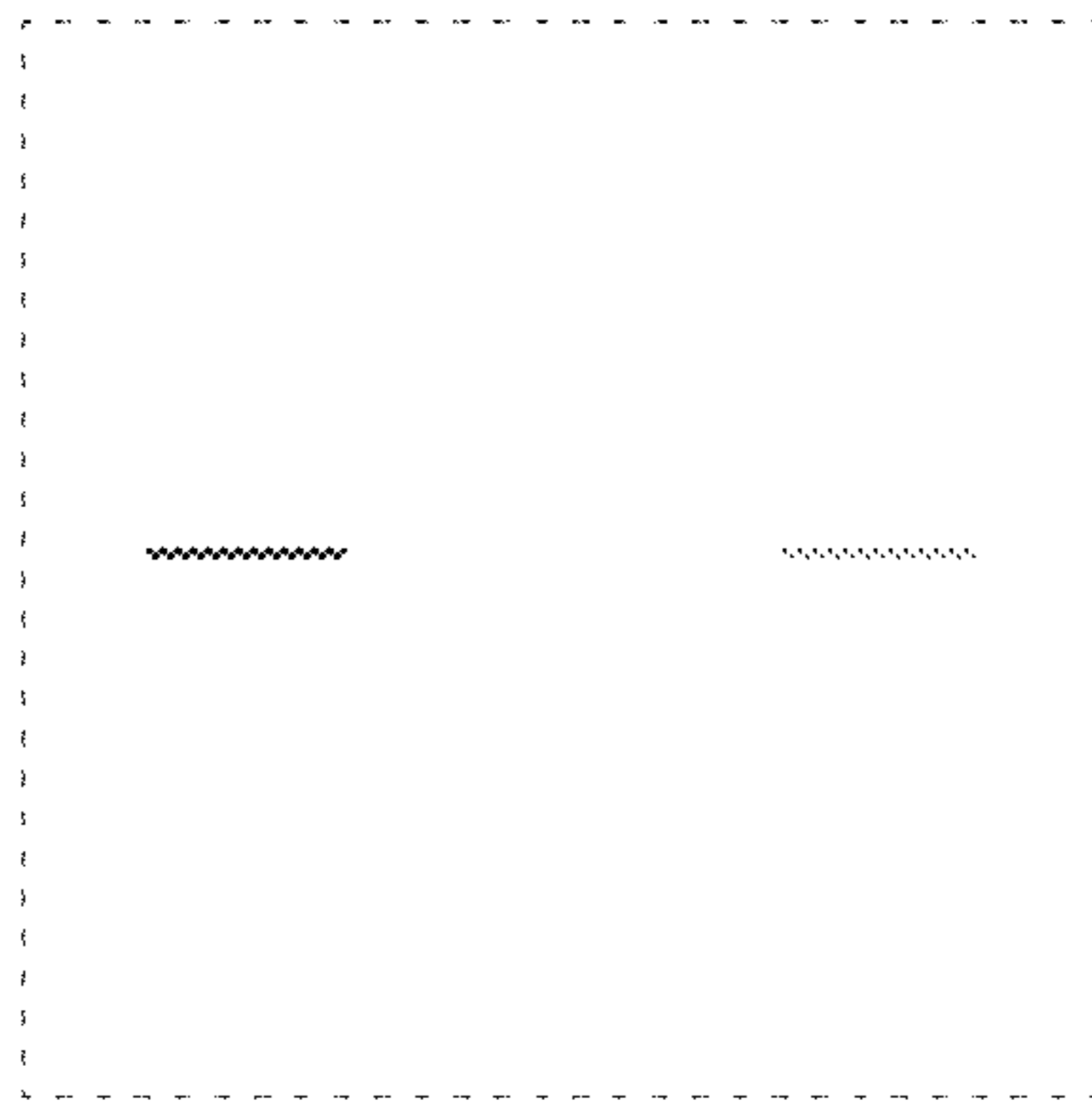




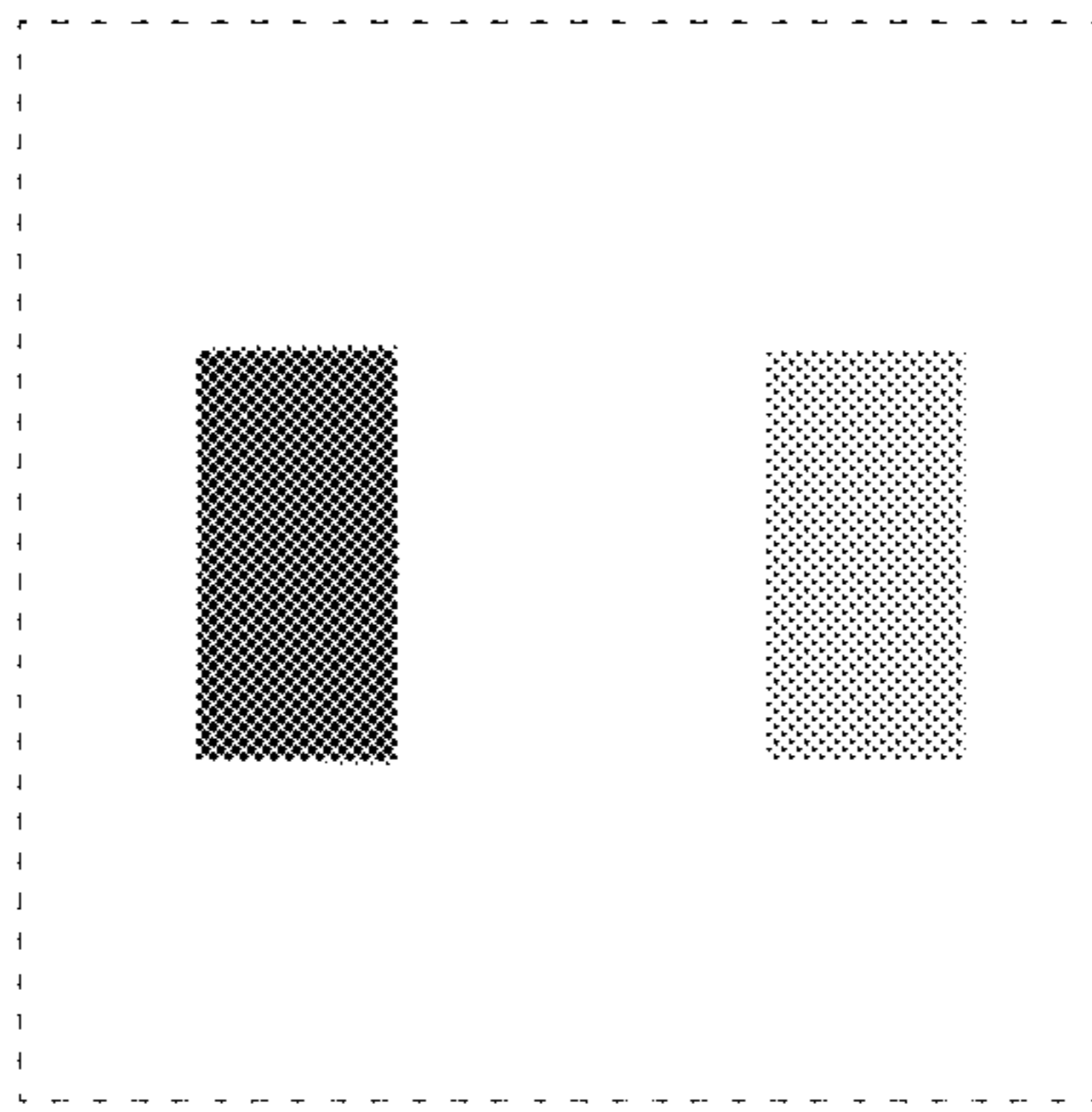
**FIG. 7**



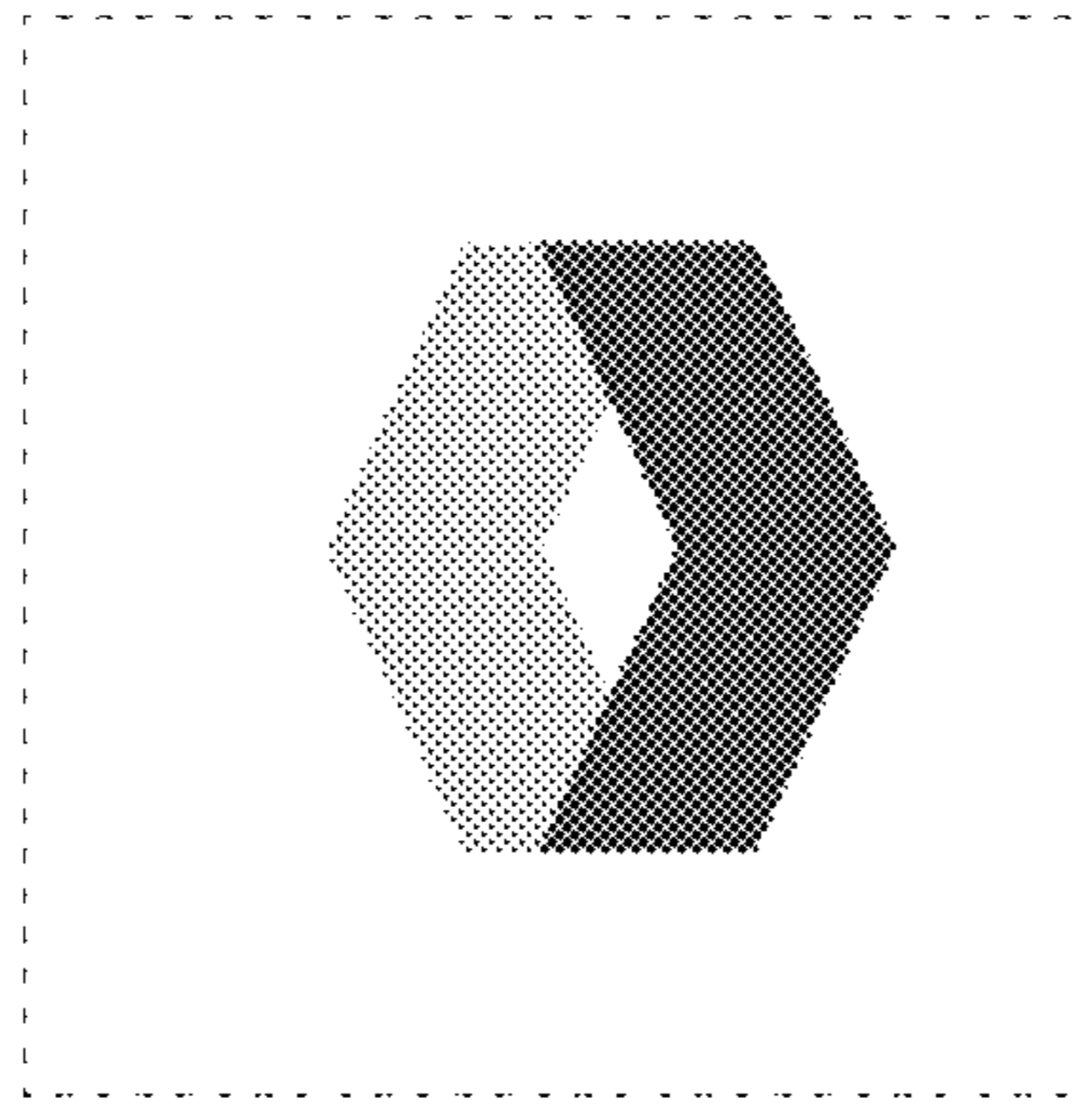
**FIG. 8**



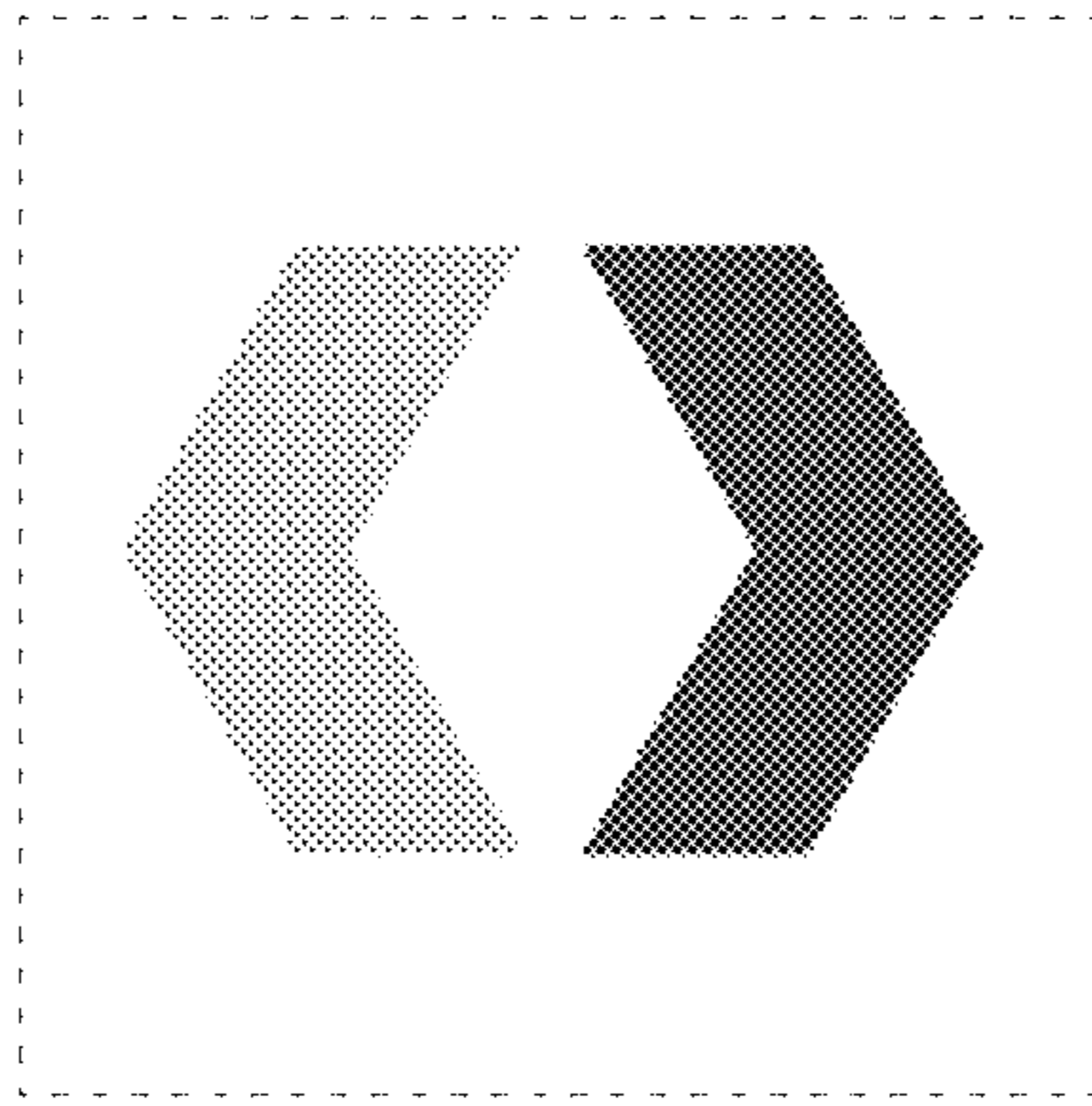
**FIG. 9**



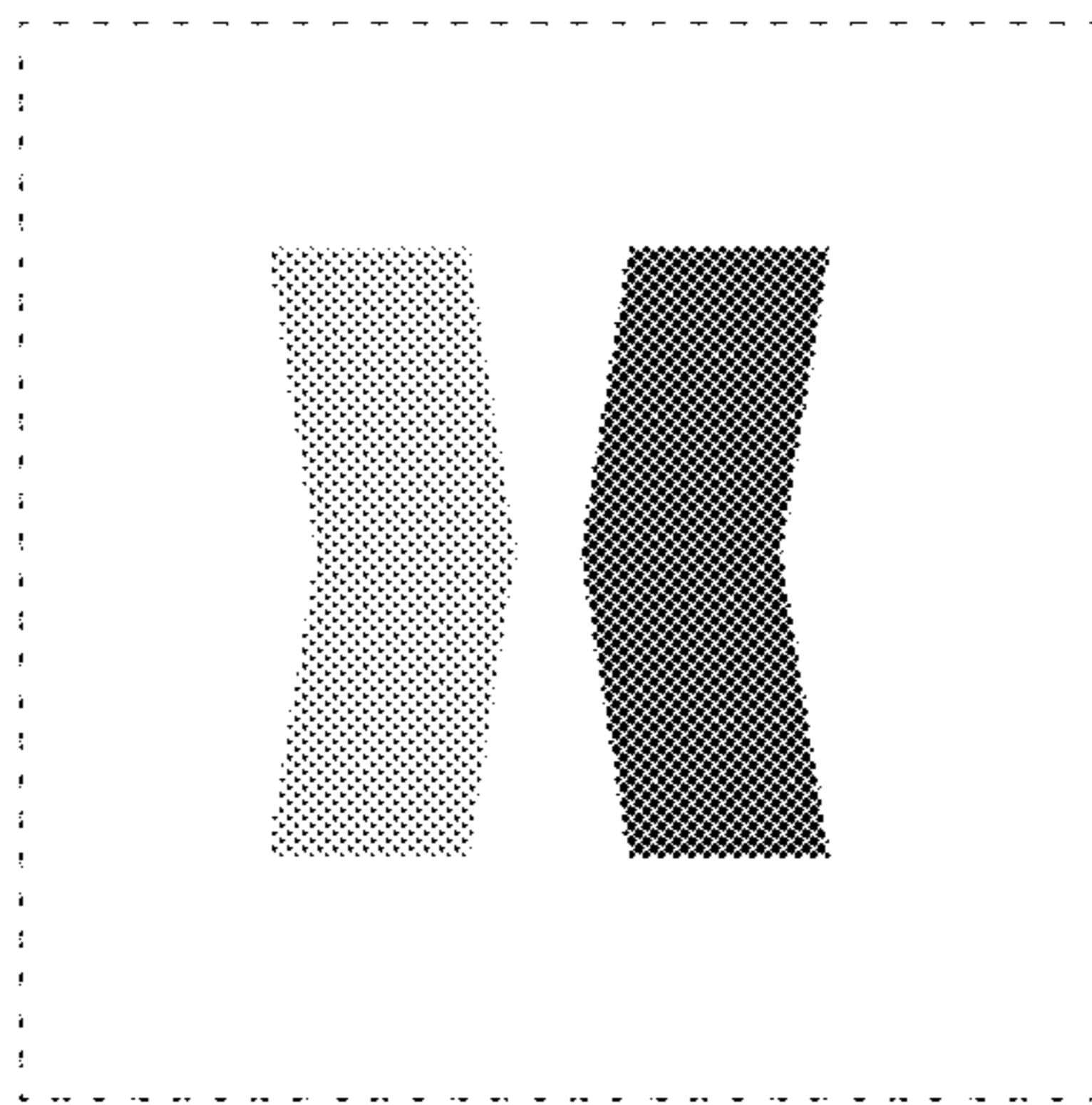
**FIG. 10**



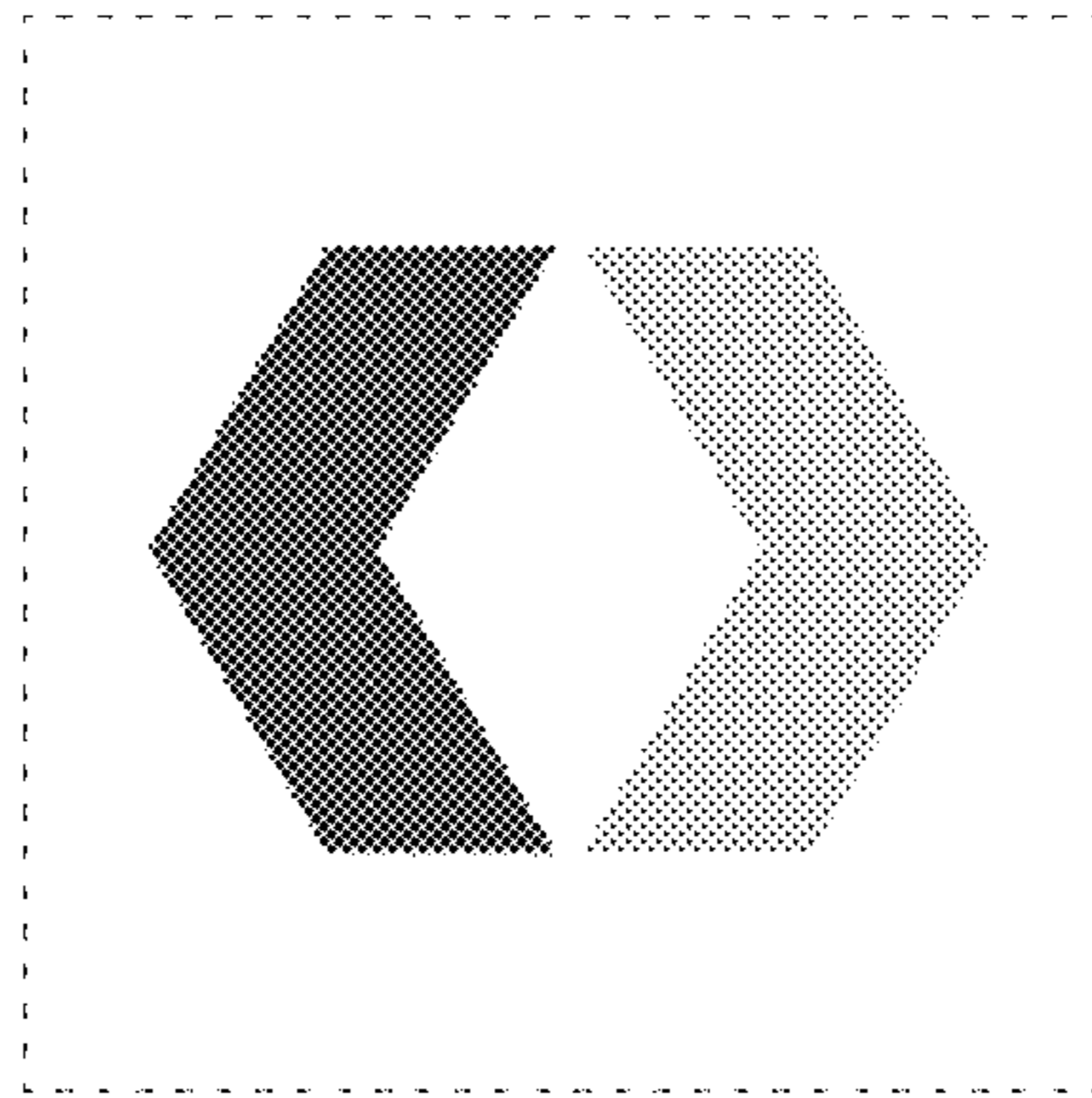
**FIG. 11**



**FIG. 12**

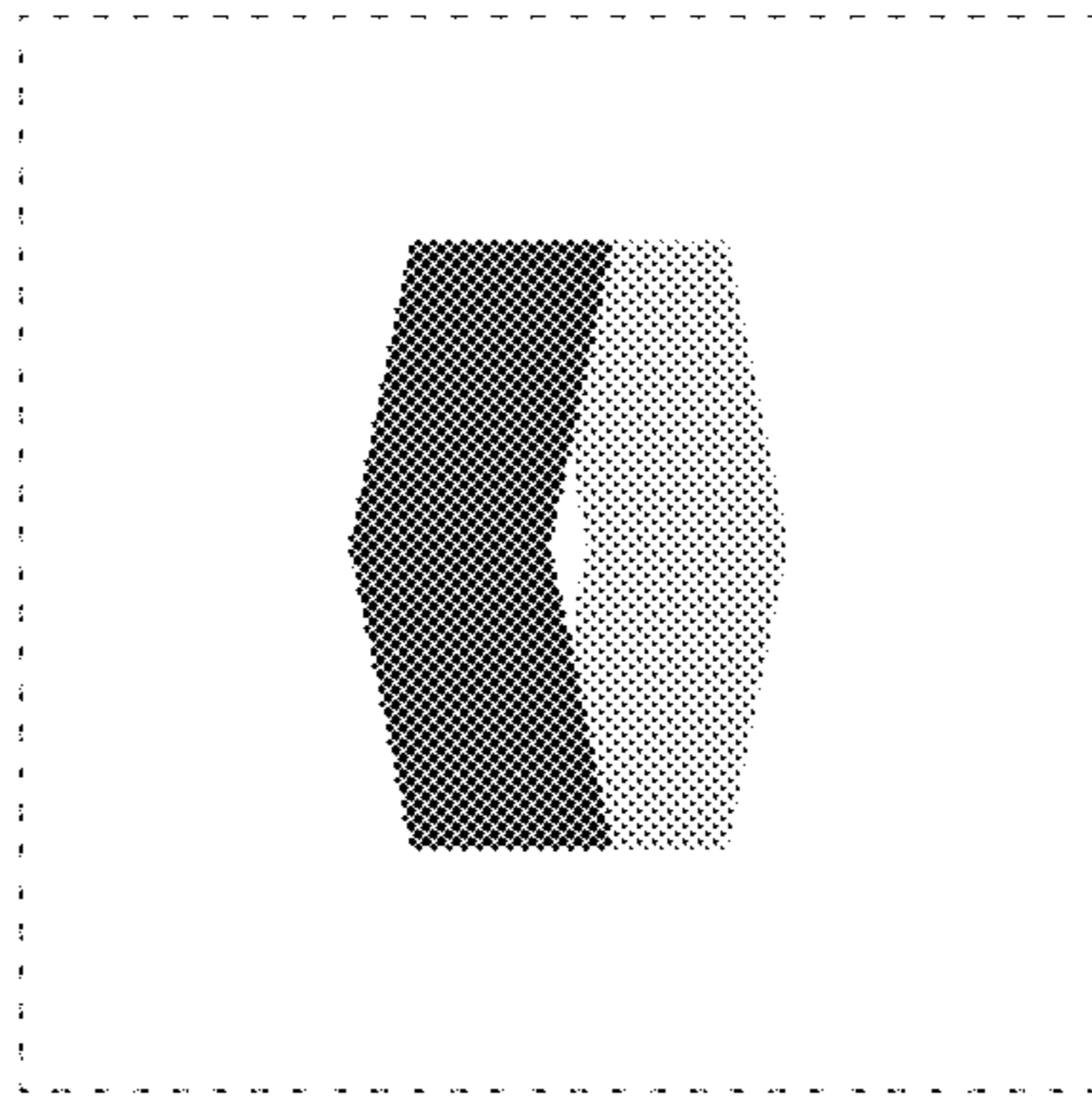


**FIG. 13**

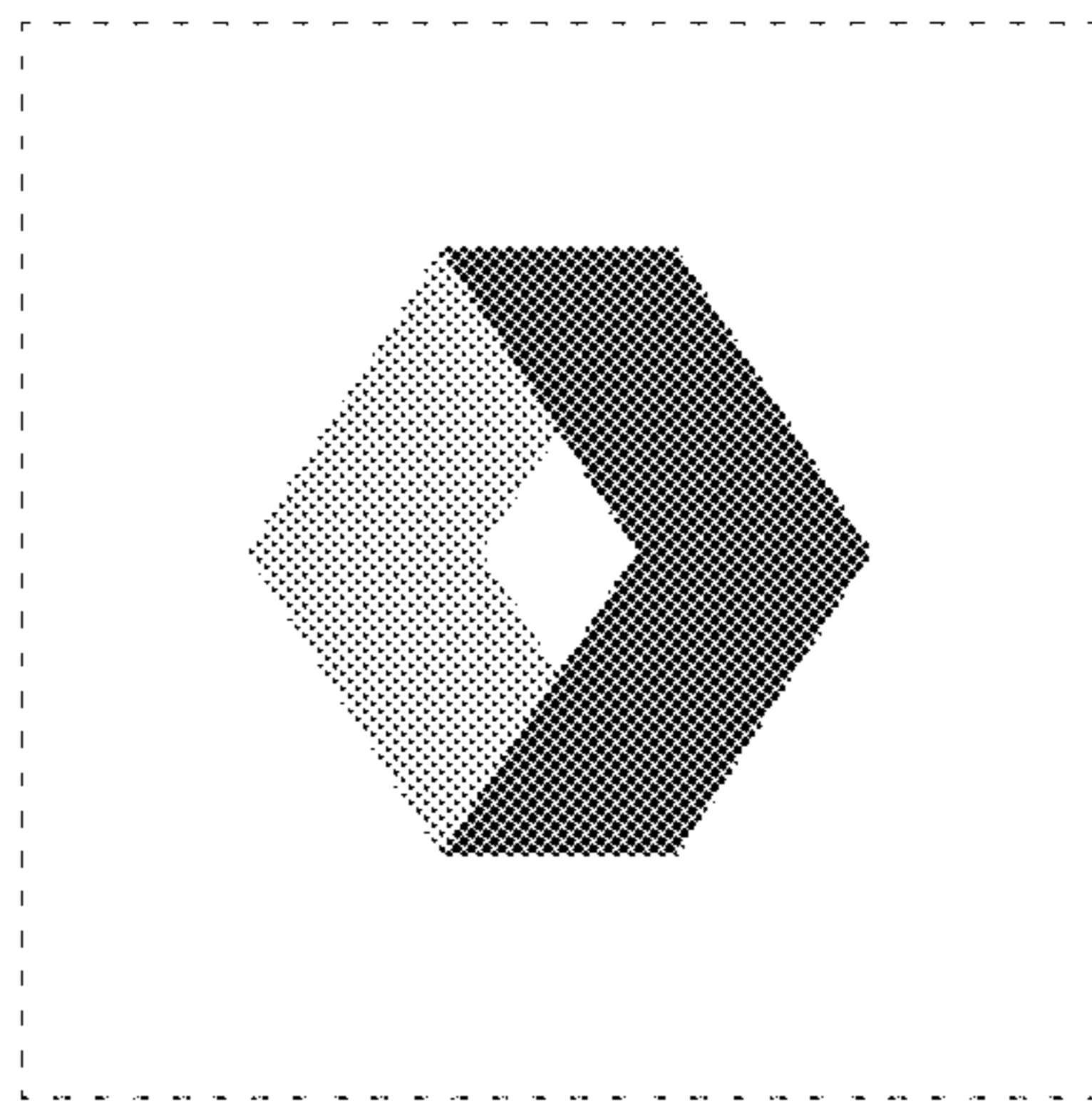


**FIG. 14**





**FIG. 15**



**FIG. 16**