



US00D980213S

(12) **United States Design Patent**  
**Woo et al.**

(10) **Patent No.:** **US D980,213 S**  
(45) **Date of Patent:** **\*\* Mar. 7, 2023**

(54) **HEAD MOUNT DISPLAY**

(71) Applicant: **Samsung Electronics Co., Ltd.**,  
Suwon-si (KR)  
(72) Inventors: **Giha Woo**, Suwon-si (KR); **Yonghee Cho**,  
Suwon-si (KR); **Myungkyu Kim**,  
Suwon-si (KR); **Woojung Moon**,  
Suwon-si (KR); **Minki Ham**, Suwon-si  
(KR); **Hangil Song**, Suwon-si (KR)

(73) Assignee: **SAMSUNG ELECTRONICS CO., LTD.**,  
Suwon-si (KR)

(\*\*) Term: **15 Years**

(21) Appl. No.: **29/777,259**

(22) Filed: **Apr. 5, 2021**

(30) **Foreign Application Priority Data**

Oct. 6, 2020 (KR) ..... 30-2020-0047804

(51) **LOC (14) Cl.** ..... **14-02**

(52) **U.S. Cl.**  
USPC ..... **D14/372**

(58) **Field of Classification Search**  
USPC ..... D14/372, 496, 432, 371, 125, 126, 129,  
D14/299; D16/300-342; 351/158, 153,  
351/144; 345/7-9, 905; 455/344;  
348/115, 53, 121, 739  
CPC ..... G02B 27/017; G02B 27/0158; G02B  
27/0161; G02B 27/0181; G02B 27/0185;  
G02B 27/0189

See application file for complete search history.

(56) **References Cited**

U.S. PATENT DOCUMENTS

D727,317 S	*	4/2015	Olsson	.....	D14/372
D732,531 S	*	6/2015	Kim	.....	D14/372
D741,859 S	*	10/2015	Bosveld	.....	D14/372
D749,584 S	*	2/2016	Olsson	.....	D14/372
D765,075 S	*	8/2016	Rochat	.....	D14/372
D800,726 S	*	10/2017	Su	.....	D14/372
D830,359 S	*	10/2018	Gribetz	.....	D14/372

\* cited by examiner

*Primary Examiner* — Austin Murphy

(74) *Attorney, Agent, or Firm* — McAndrews Held & Malloy, Ltd.

(57) **CLAIM**

The ornamental design for a head mount display, as shown and described.

**DESCRIPTION**

FIG. 1 is a front perspective view of a head mount display showing our new design;  
FIG. 2 is a front elevation view thereof;  
FIG. 3 is a rear elevation view thereof;  
FIG. 4 is a left side elevation view thereof;  
FIG. 5 is a right side elevation view thereof;  
FIG. 6 is a top plan view thereof;  
FIG. 7 is a bottom plan view thereof;  
FIG. 8 is a rear perspective view thereof; and,  
FIG. 9 is the front perspective view of FIG. 1 showing the head mount display with a visor to be combined therewith. The visor shown in evenly-dashed broken lines in FIG. 9 forms no part of the claimed design. The remaining evenly-dashed broken lines in the drawings illustrate portions of the head mount display that form no part of the claimed design.

**1 Claim, 7 Drawing Sheets**

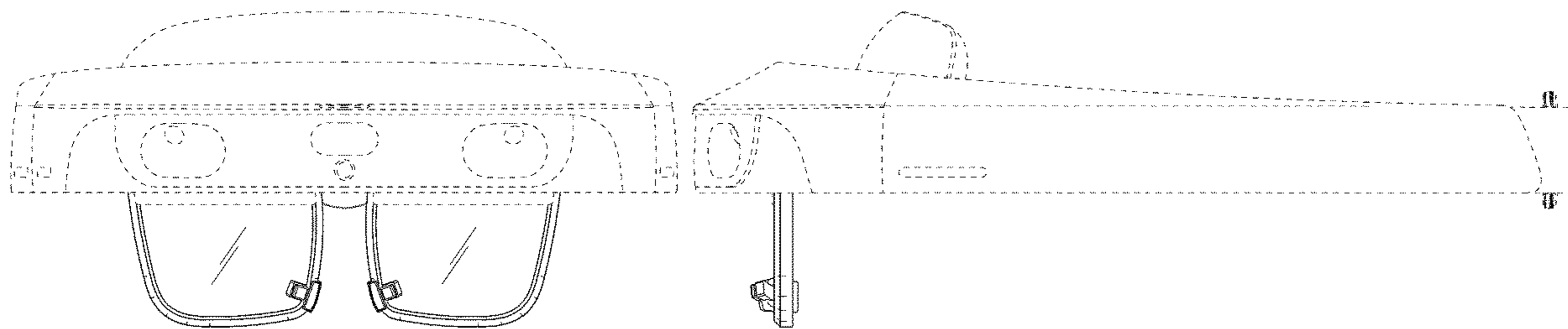

FIG.1

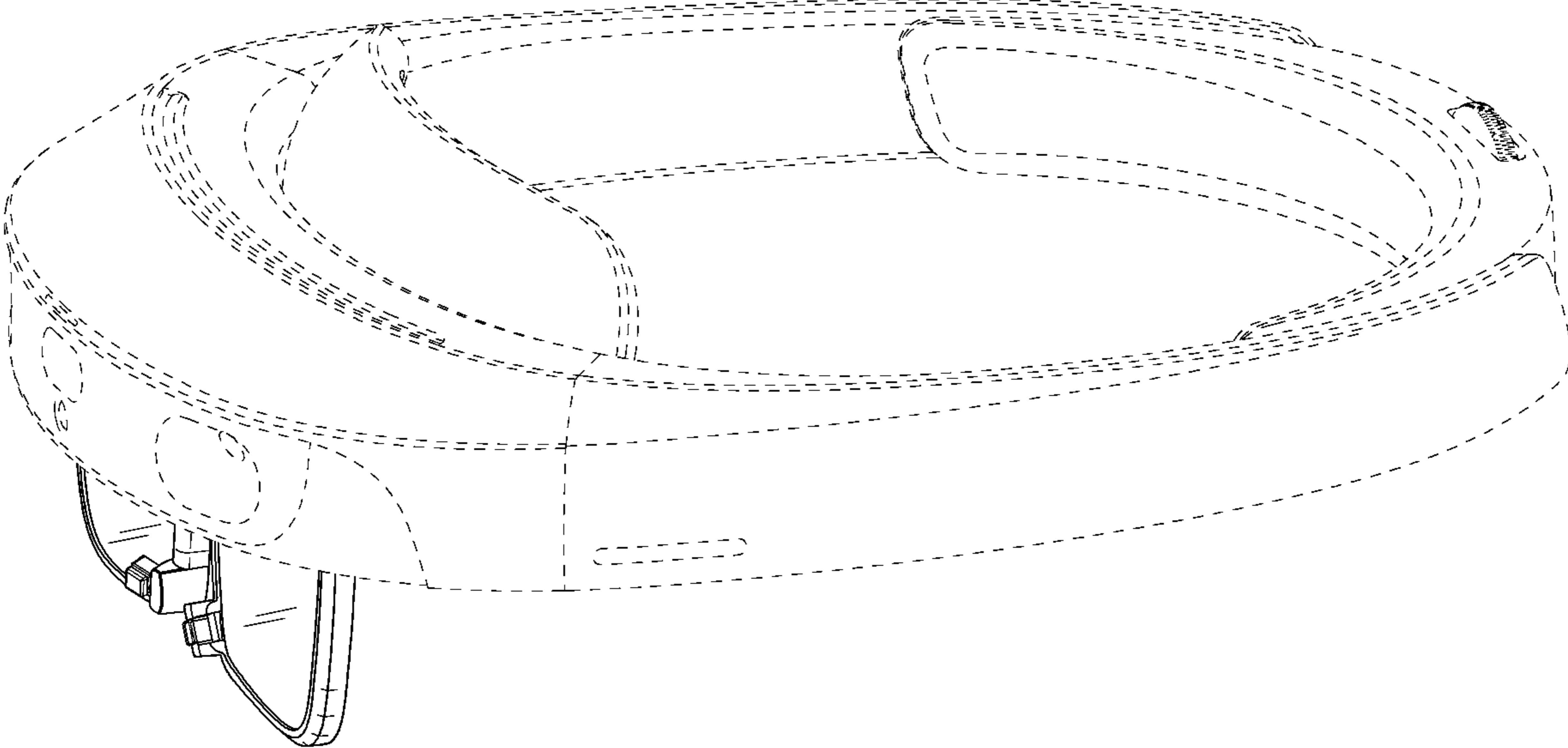

FIG.2

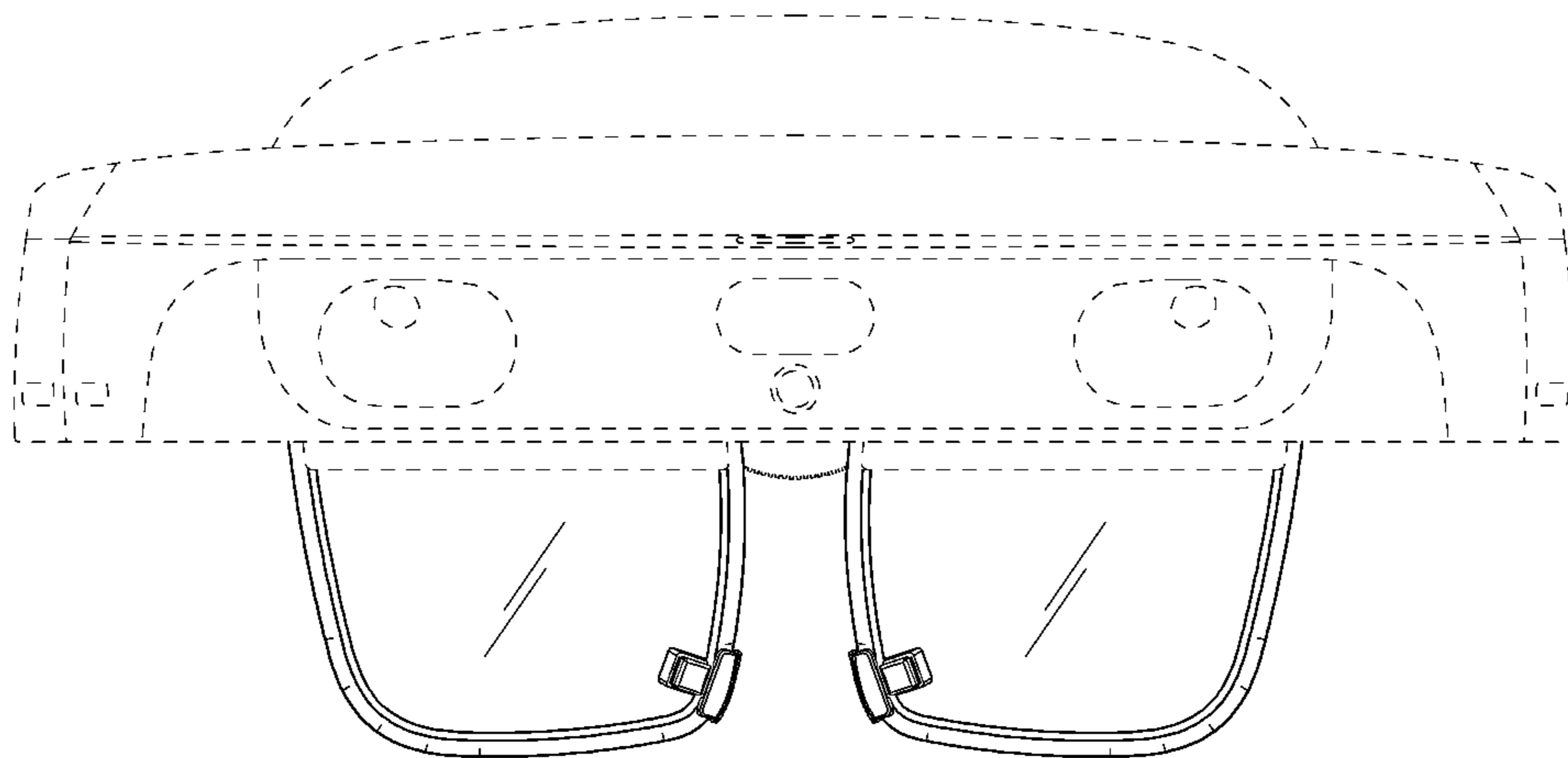

FIG.3

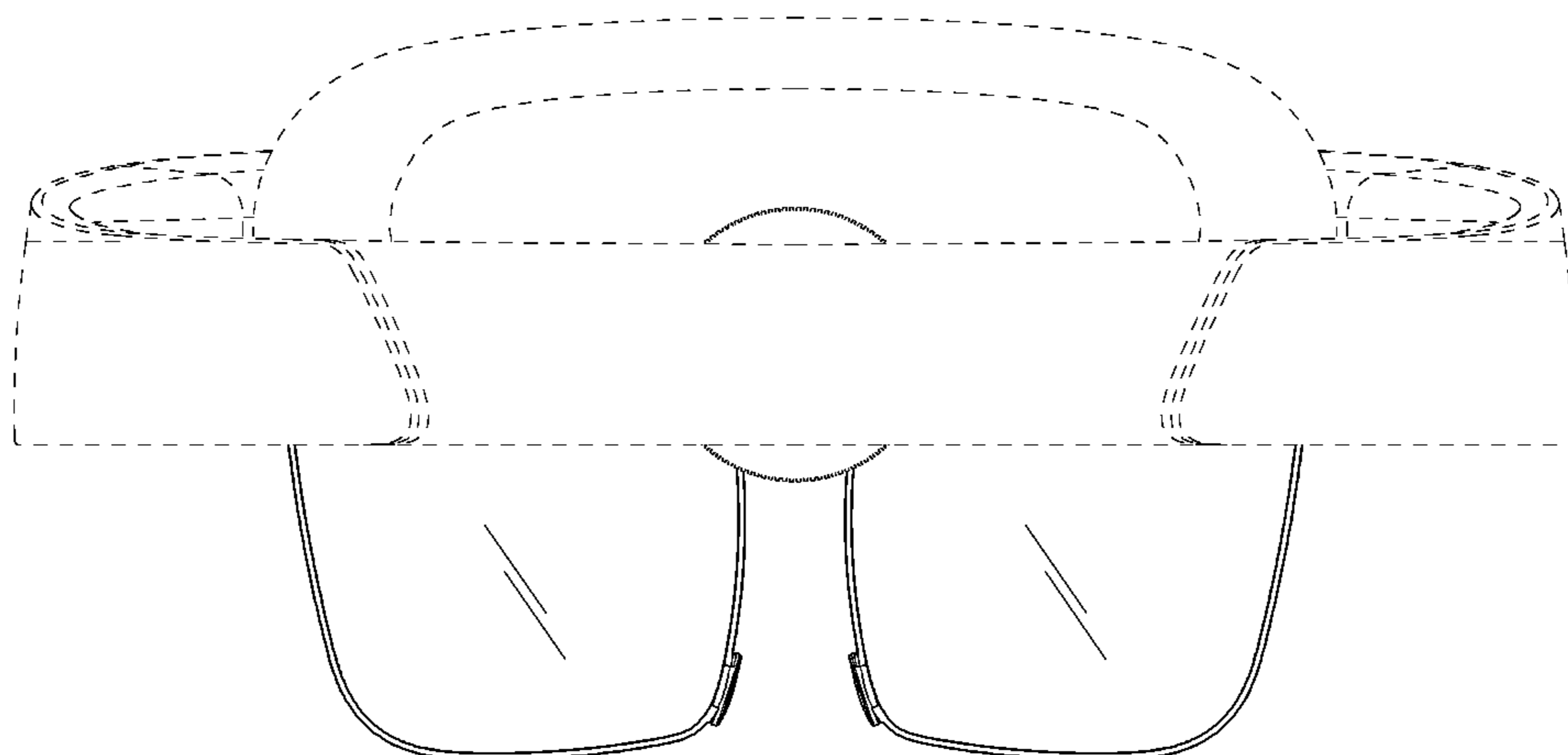

FIG.4

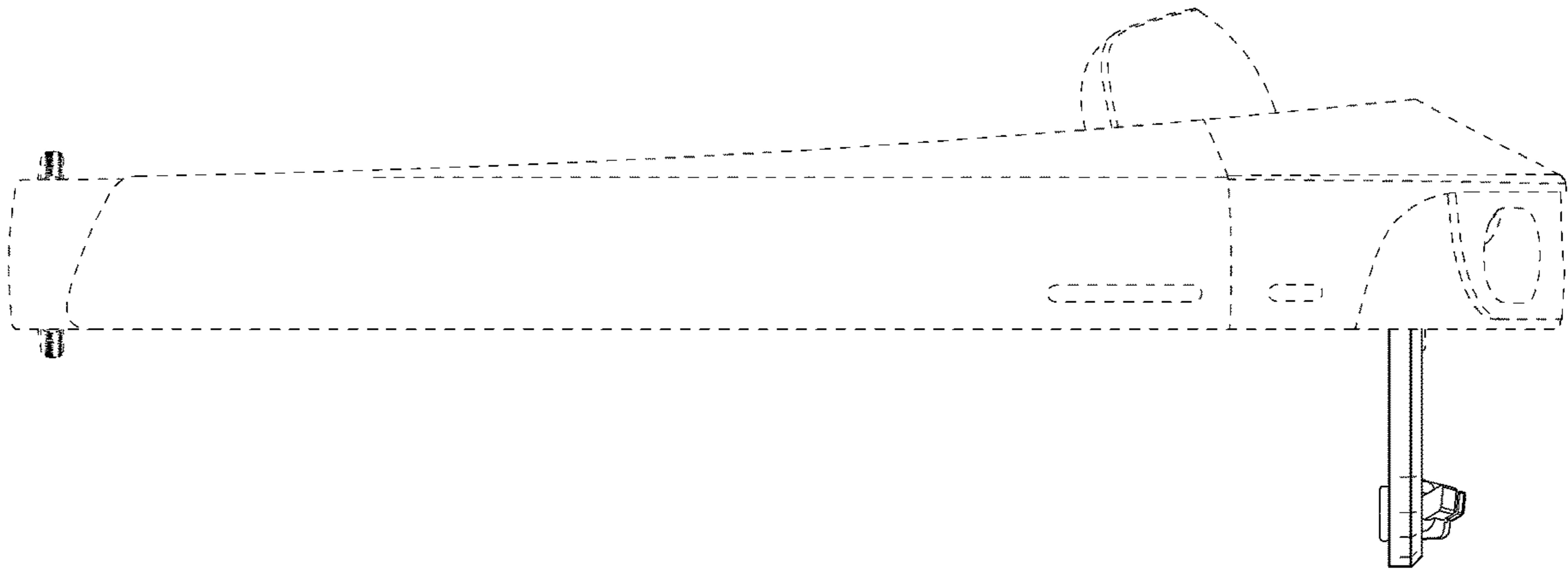

FIG.5

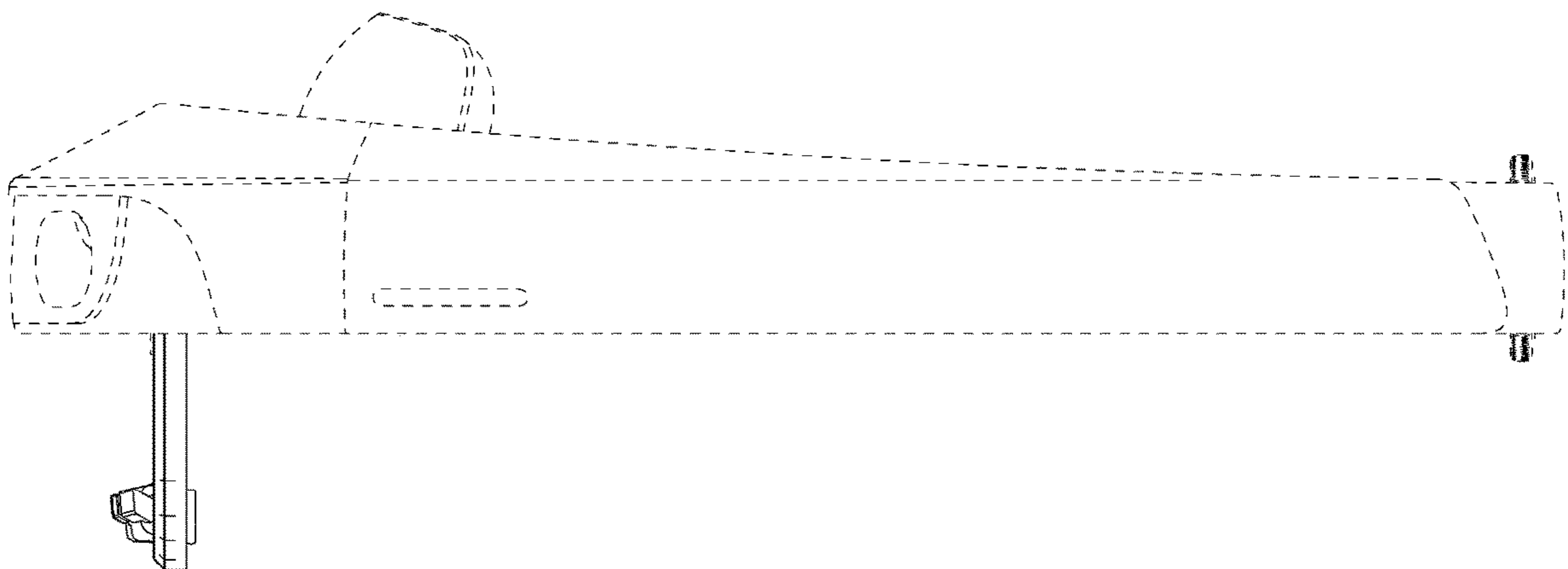

FIG.6

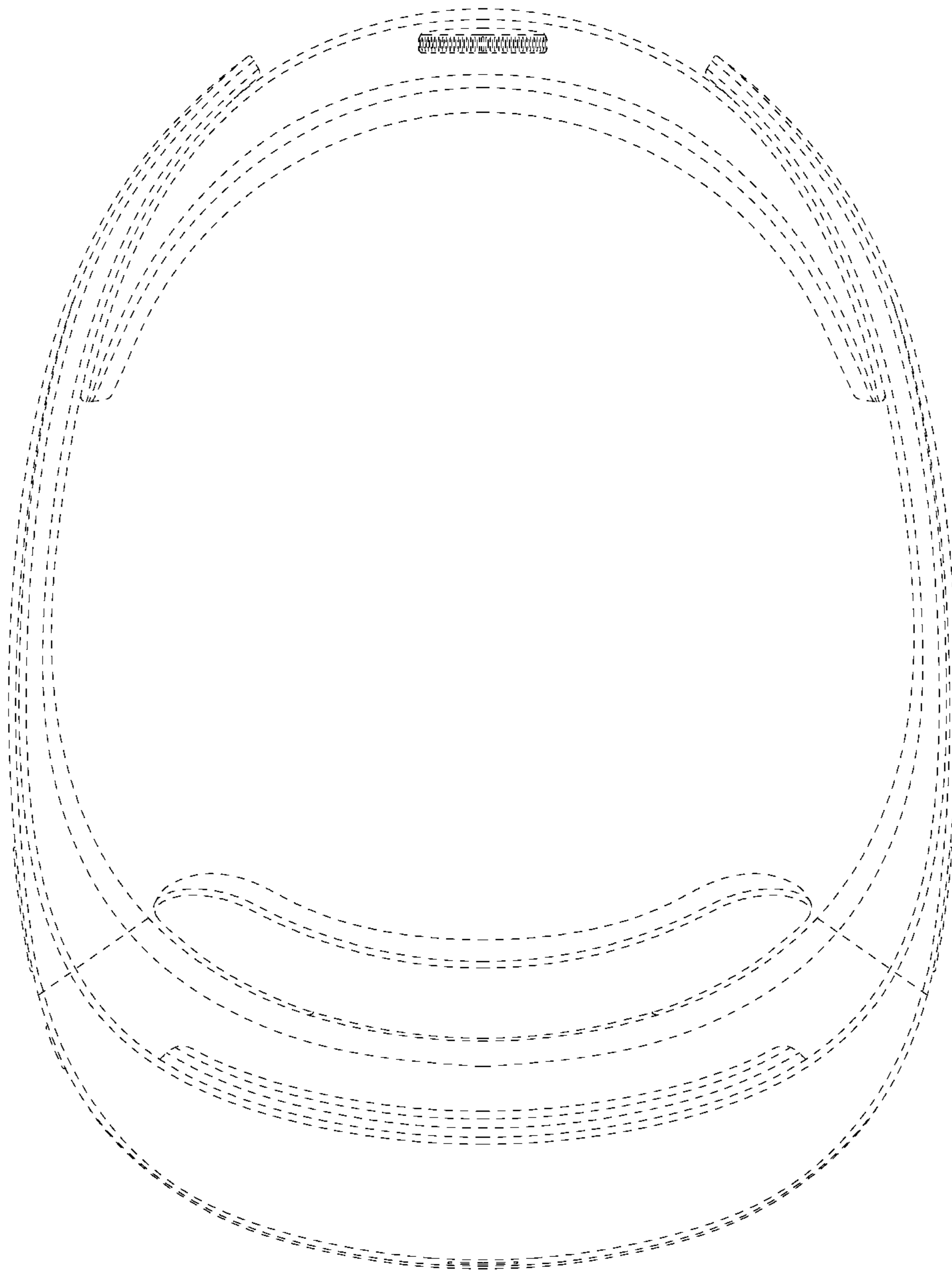

FIG.7

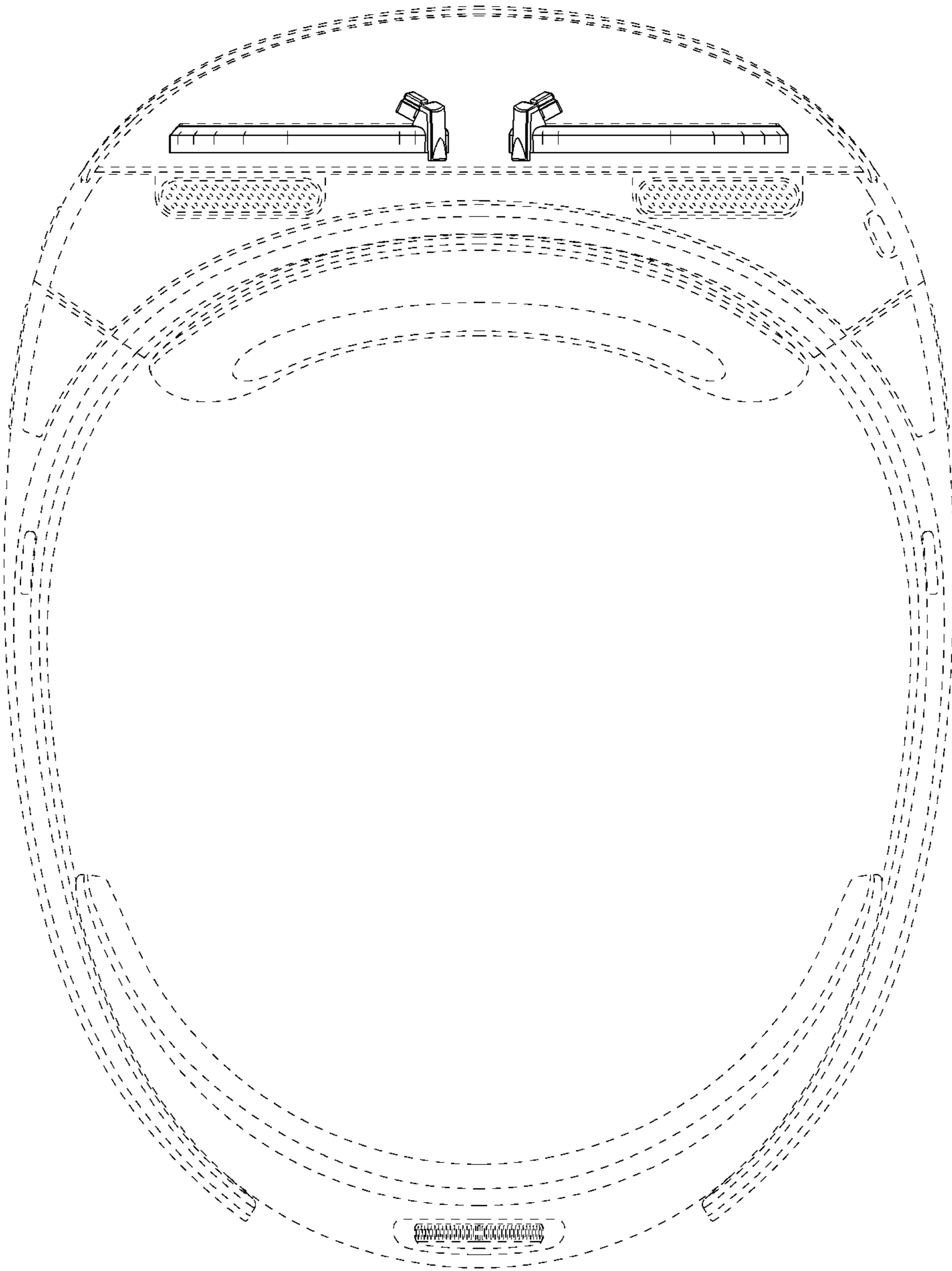

FIG.8

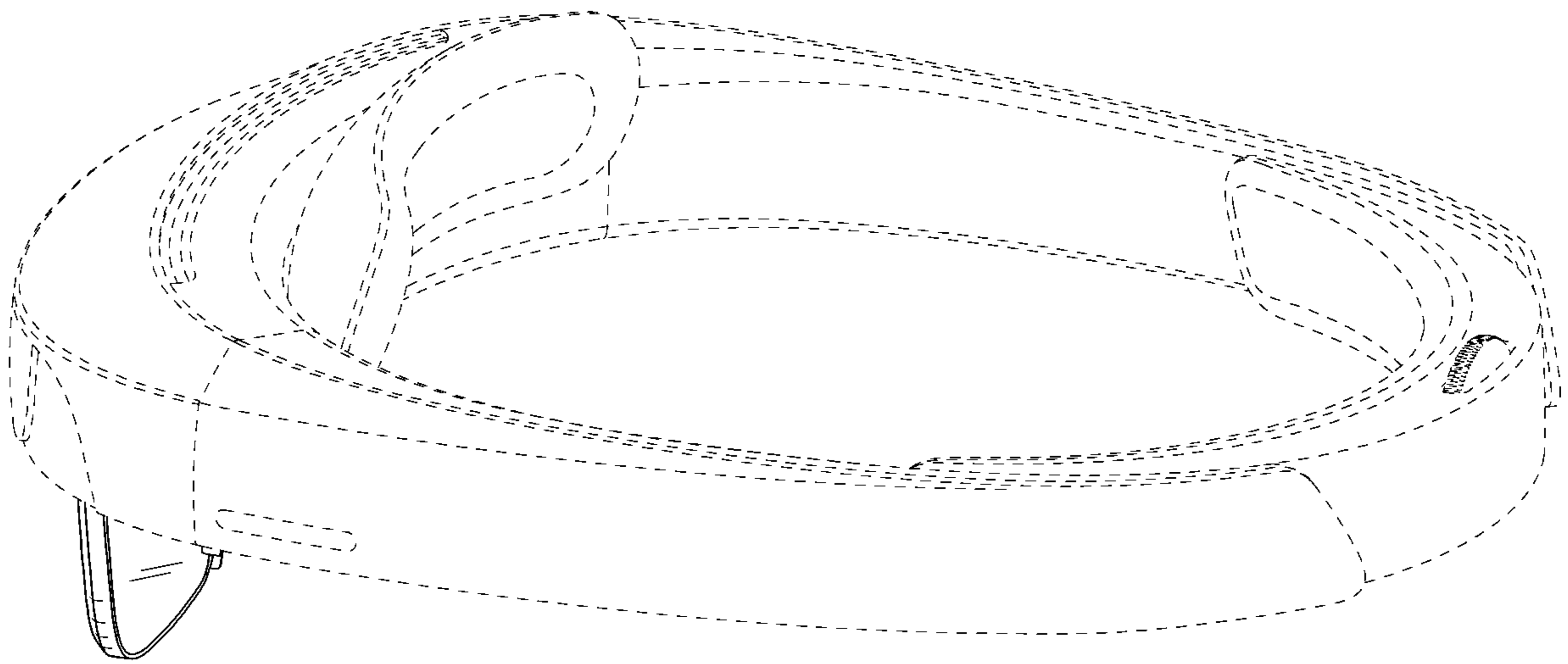

FIG.9

