



US00D980103S

(12) **United States Design Patent**
Huang

(10) **Patent No.:** **US D980,103 S**
(45) **Date of Patent:** **** Mar. 7, 2023**

(54) **PROTECTIVE CASE FOR A WATCH**

DESCRIPTION

(71) Applicant: **Wei Huang**, Hechi (CN)
(72) Inventor: **Wei Huang**, Hechi (CN)
(**) Term: **15 Years**
(21) Appl. No.: **29/851,035**
(22) Filed: **Aug. 25, 2022**
(51) **LOC (14) Cl.** **10-07**
(52) **U.S. Cl.**
USPC **D10/132**
(58) **Field of Classification Search**
USPC D10/30-39, 122, 128, 129-132; D11/3,
D11/91; D14/344, 440
CPC A44C 5/00; A44C 17/0291; A44C 5/0007;
A44C 5/147; A44C 17/02; G04B 37/005;
G04B 37/0058; G04B 37/084; G04B
37/087
See application file for complete search history.

FIG. 1 is a front, right and top perspective view of a first embodiment of a protective case for a watch, showing my new design;
FIG. 2 is a rear, left and bottom perspective view thereof;
FIG. 3 is a front view thereof;
FIG. 4 is a rear view thereof;
FIG. 5 is a left side view thereof;
FIG. 6 is a right side view thereof;
FIG. 7 is a top plan view thereof;
FIG. 8 is a bottom plan view thereof;
FIG. 9 is an enlarged view of portion 9 shown in FIG. 1;
FIG. 10 is a perspective of the protective case for a watch in a detached status;
FIG. 11 is a front, right and top perspective of a second embodiment of the protective case for a watch;
FIG. 12 is a rear, left and bottom perspective view thereof;
FIG. 13 is a front view thereof;
FIG. 14 is a rear view thereof;
FIG. 15 is a left side view thereof;
FIG. 16 is a right side view thereof;
FIG. 17 is a top plan view thereof;
FIG. 18 is a bottom plan view thereof;
FIG. 19 is a perspective of the protective case for a watch in a detached status;
FIG. 20 is is a front, right and top perspective of a third embodiment of the protective case for a watch;
FIG. 21 is a rear, left and bottom perspective view thereof;
FIG. 22 is a front view thereof;
FIG. 23 is a rear view thereof;
FIG. 24 is is a left side view thereof;
FIG. 25 is a right side view thereof;
FIG. 26 is a top plan view thereof;
FIG. 27 is a bottom plan view thereof;
FIG. 28 is an enlarged view of portion 28 shown in FIG. 20;
and,
FIG. 29 is a perspective view of the protective case for a watch in a detached status.
The dot-dash broken lines depict the boundaries of the enlargements that form no part of the claimed design.

(56) **References Cited**

U.S. PATENT DOCUMENTS

D811,921 S	*	3/2018	Rabassa	D10/132
D850,968 S		6/2019	Zhang		
D882,564 S	*	4/2020	Jung	D14/344
D915,223 S	*	4/2021	Cabral	D10/39
D915,412 S	*	4/2021	Jung	D14/440
D920,147 S		5/2021	Qu		

(Continued)

Primary Examiner — Katherine Glennon
(74) *Attorney, Agent, or Firm* — Georgi Korobanov

(57) **CLAIM**

The ornamental design for a protective case for a watch, as shown and described.

1 Claim, 29 Drawing Sheets

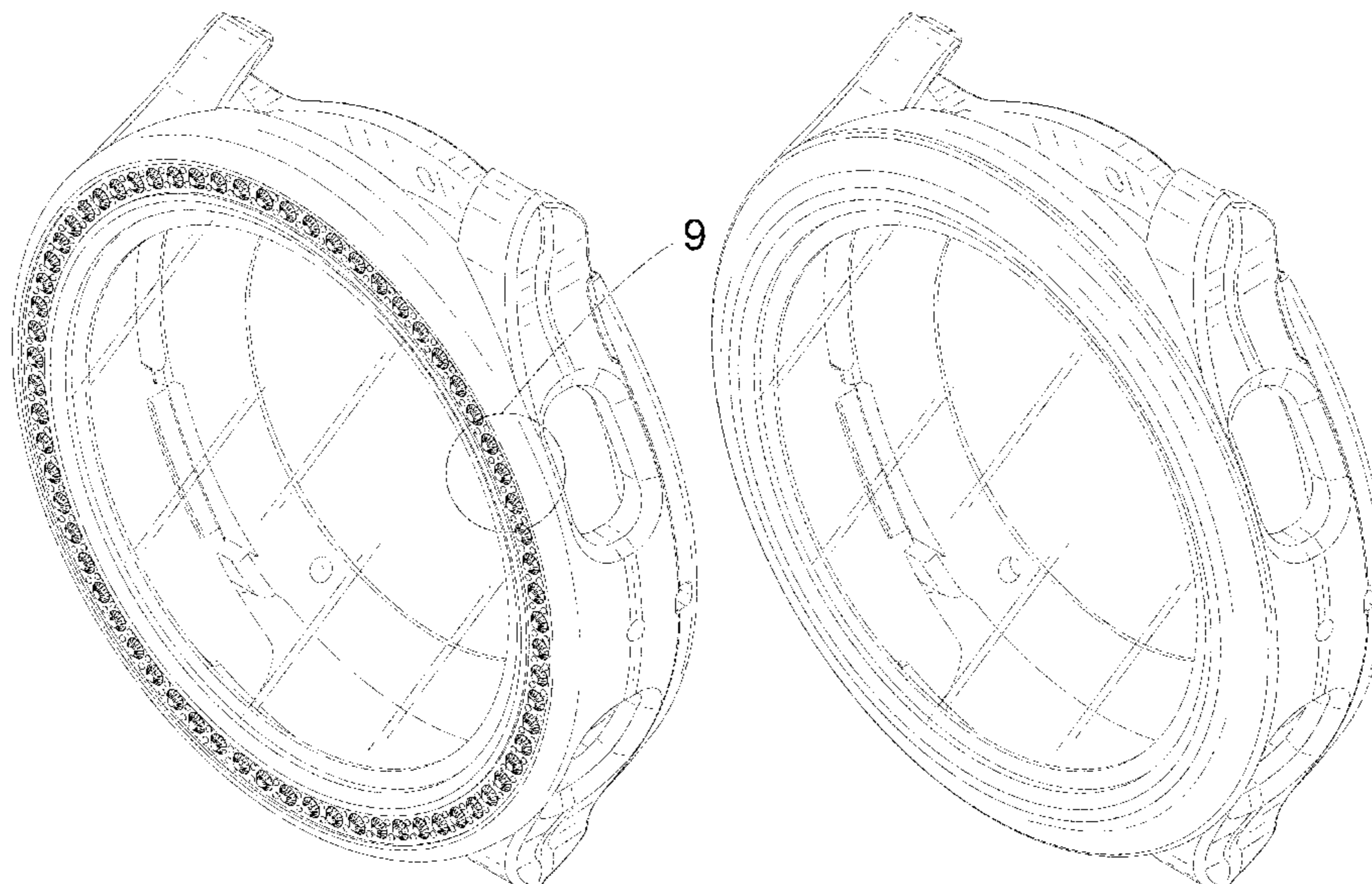

(56)

References Cited

U.S. PATENT DOCUMENTS

D957,266	S	*	7/2022	Zhou	D10/38
D960,020	S	*	8/2022	Qin	D14/440
D962,807	S	*	9/2022	Shen	D14/440
D964,200	S	*	9/2022	Tang	D10/32
D971,767	S	*	12/2022	Shen	D10/132
2019/0369563	A1	*	12/2019	Chen	F16J 15/022

* cited by examiner

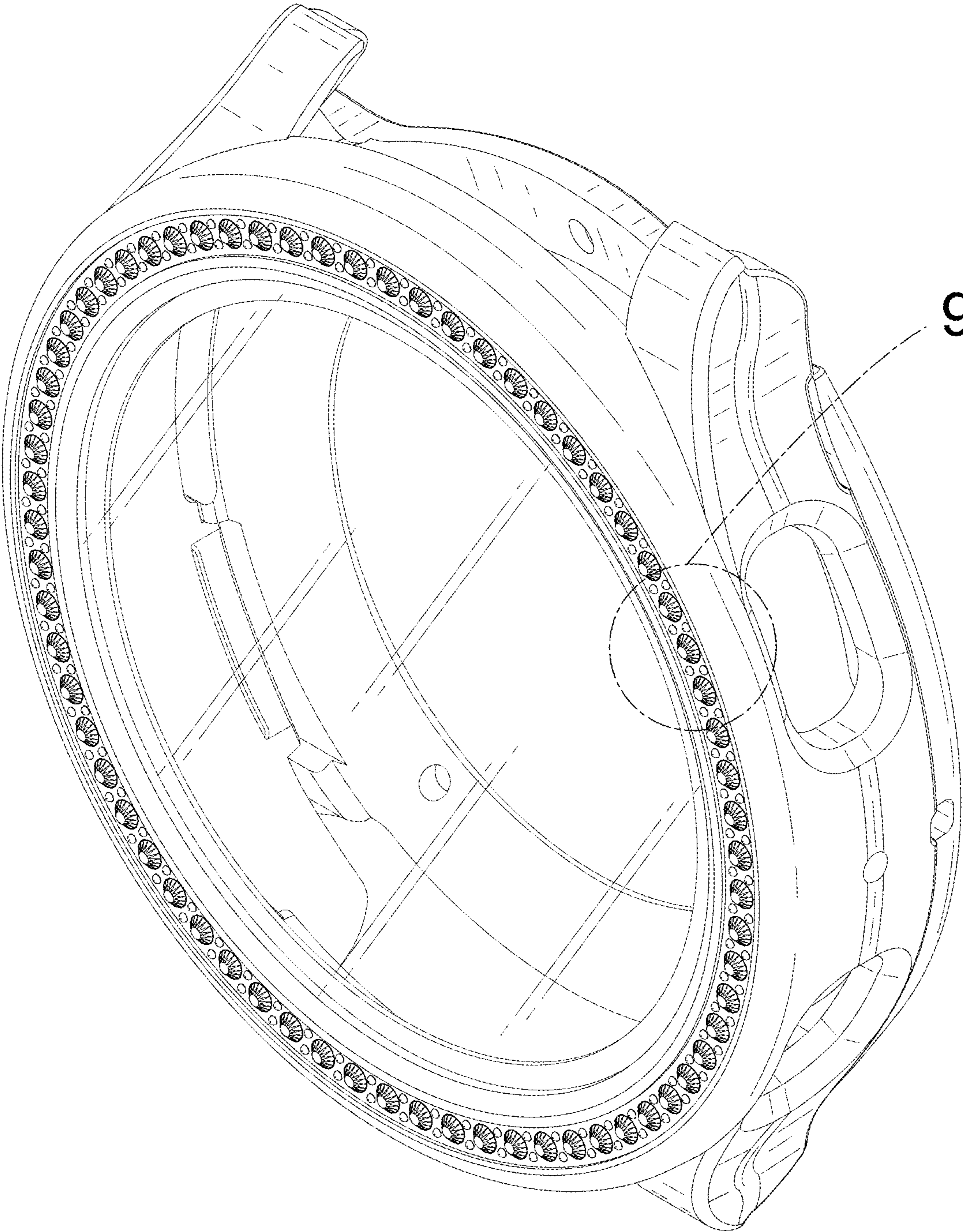

FIG. 1

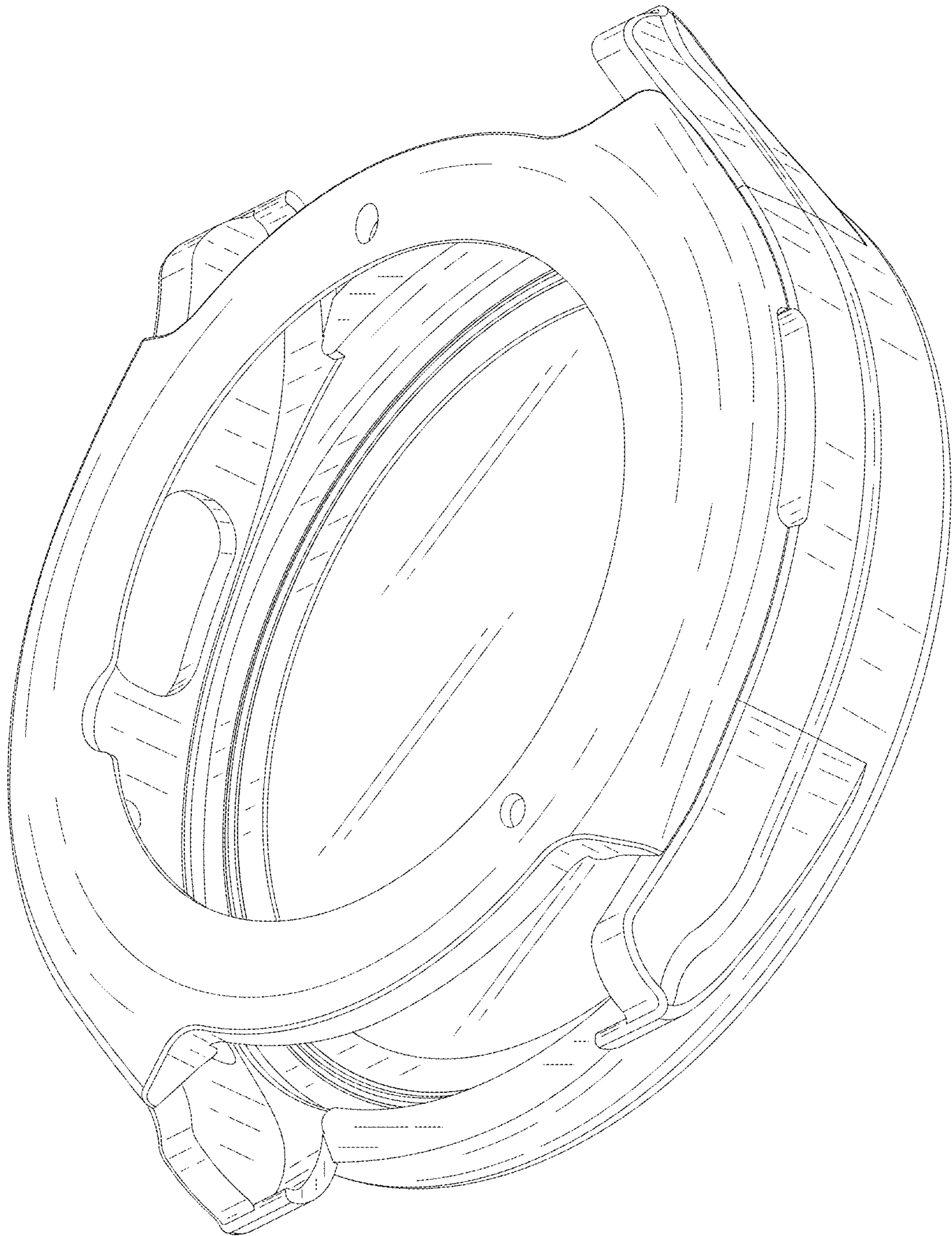

FIG. 2

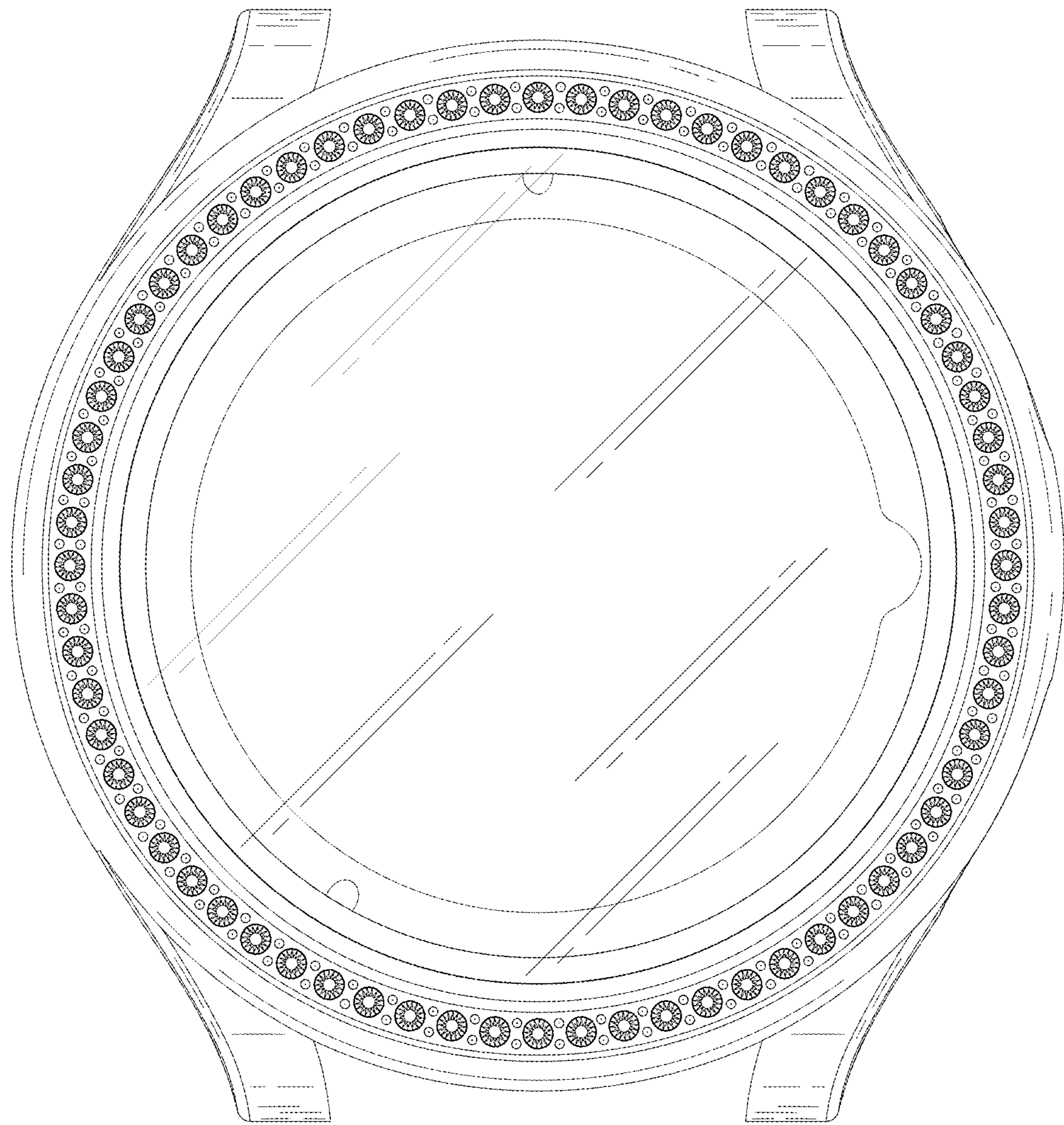

FIG. 3



FIG. 4

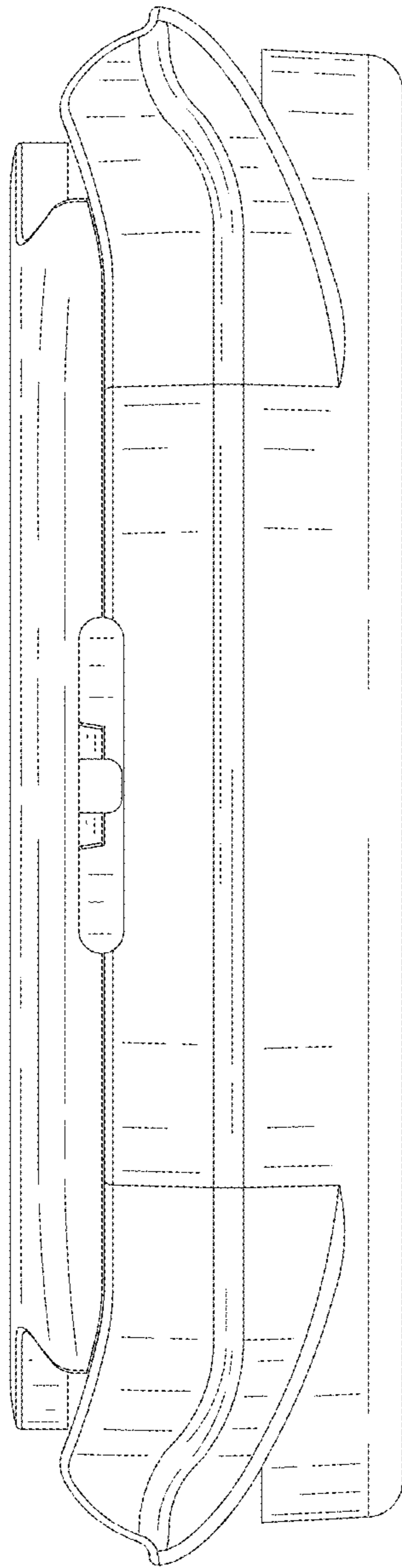

FIG. 5

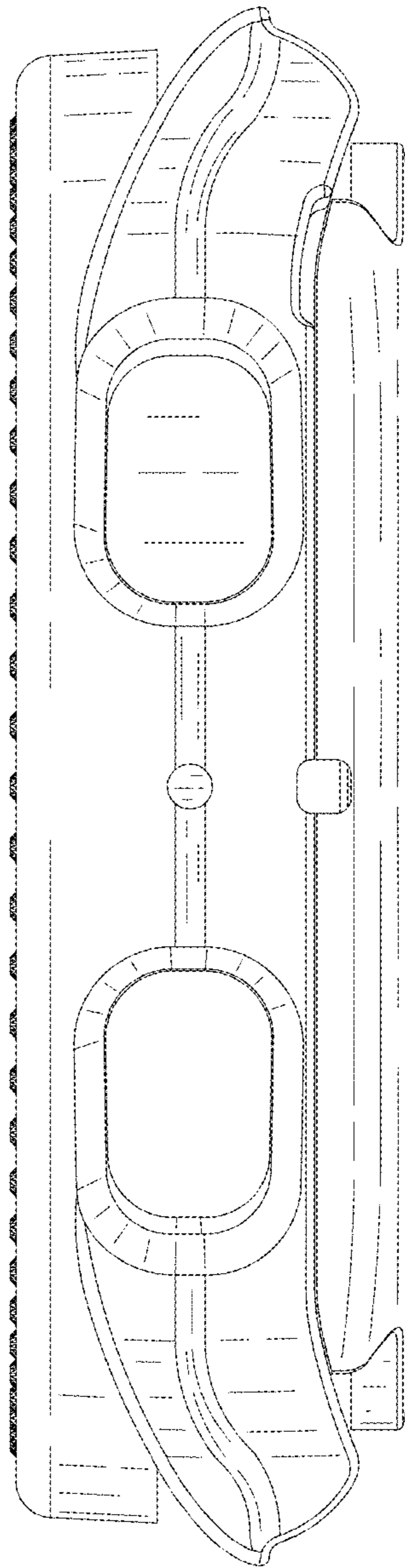

FIG. 6

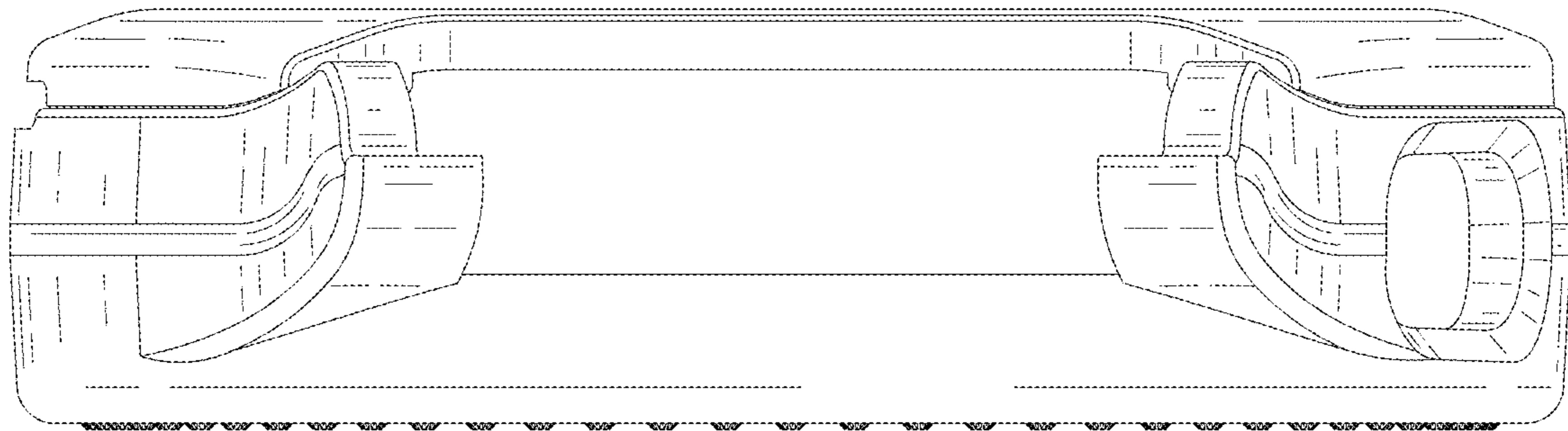

FIG. 7

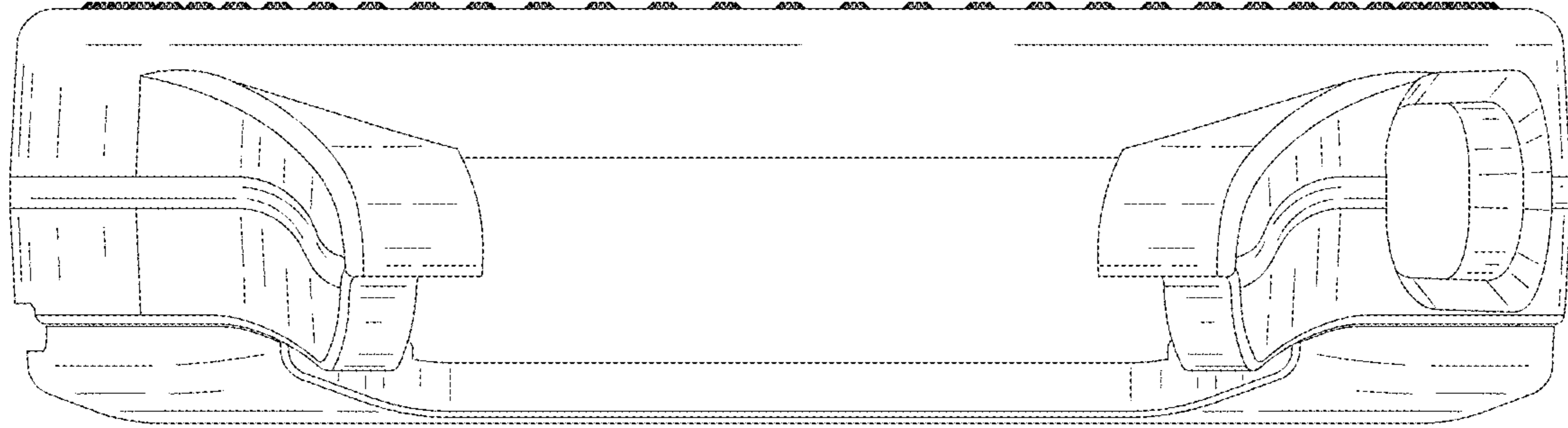

FIG. 8

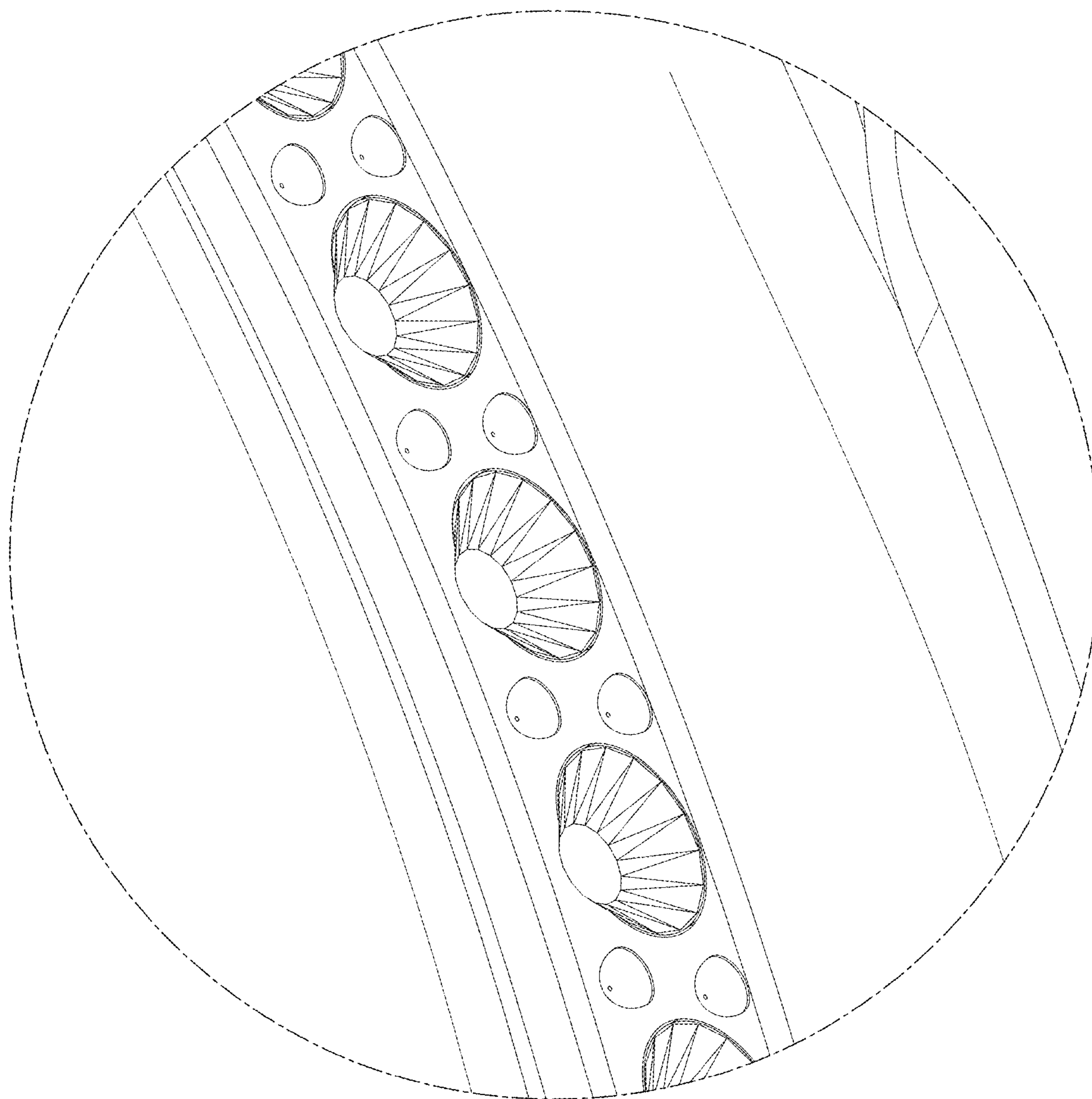

FIG. 9

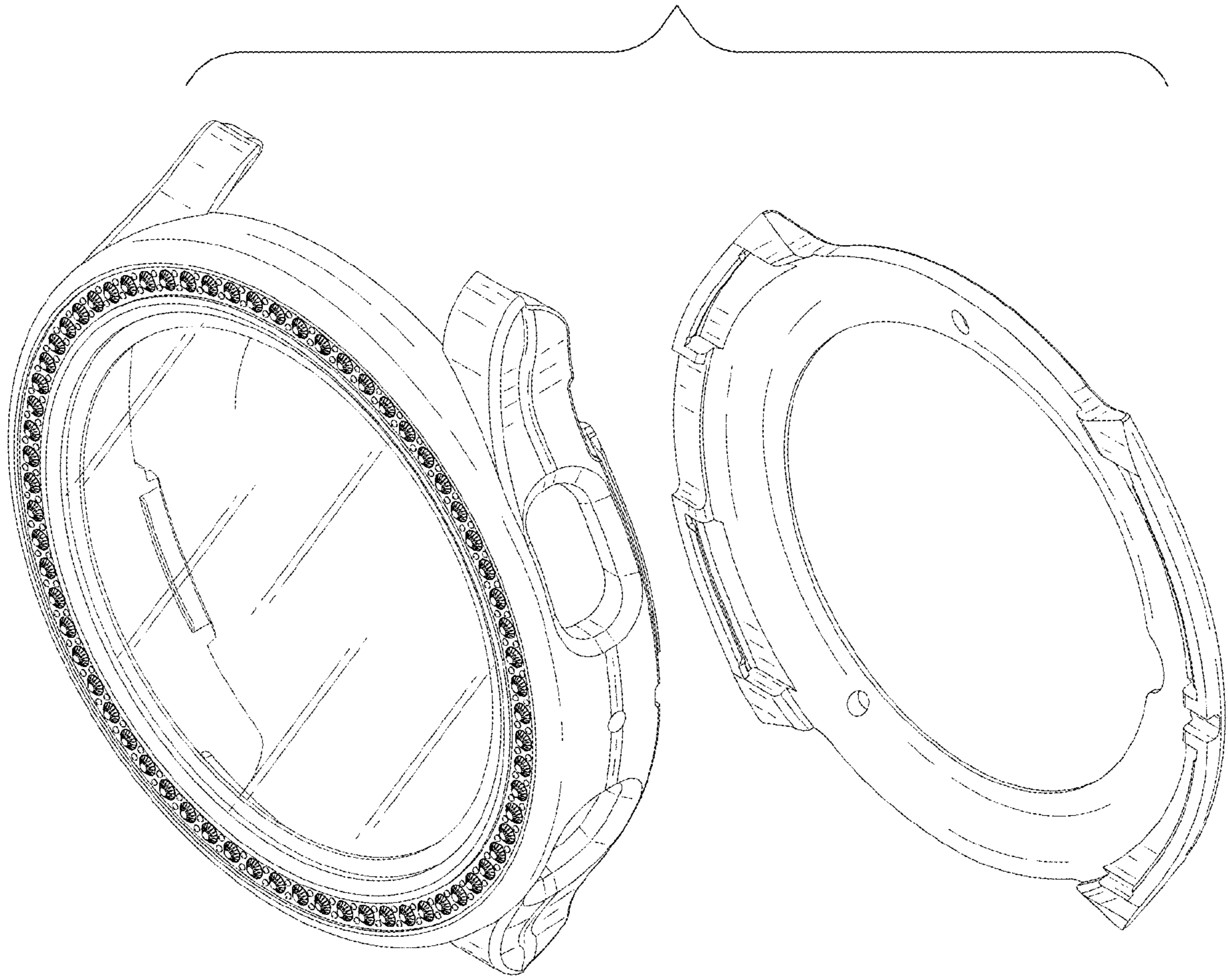

FIG. 10

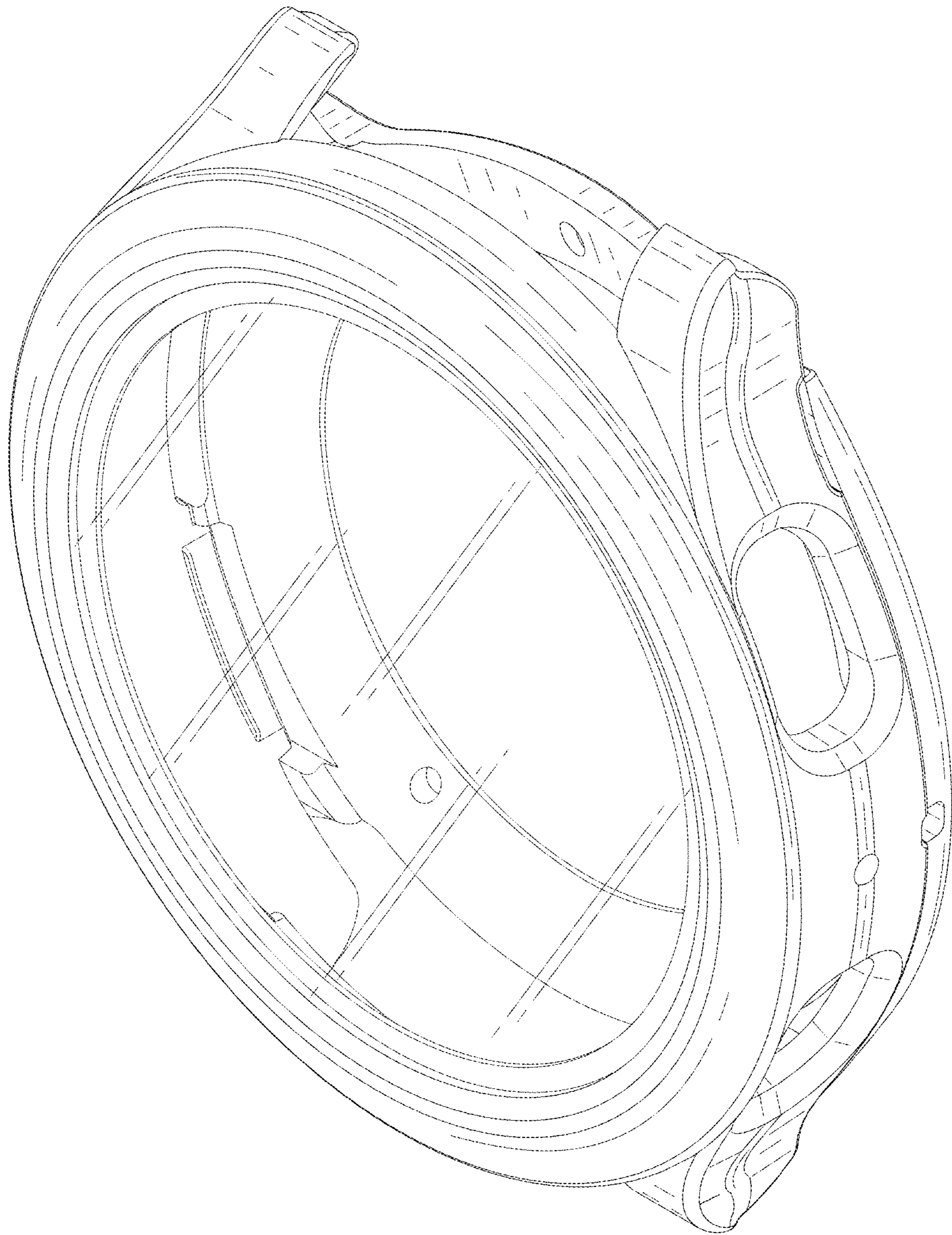

FIG. 11

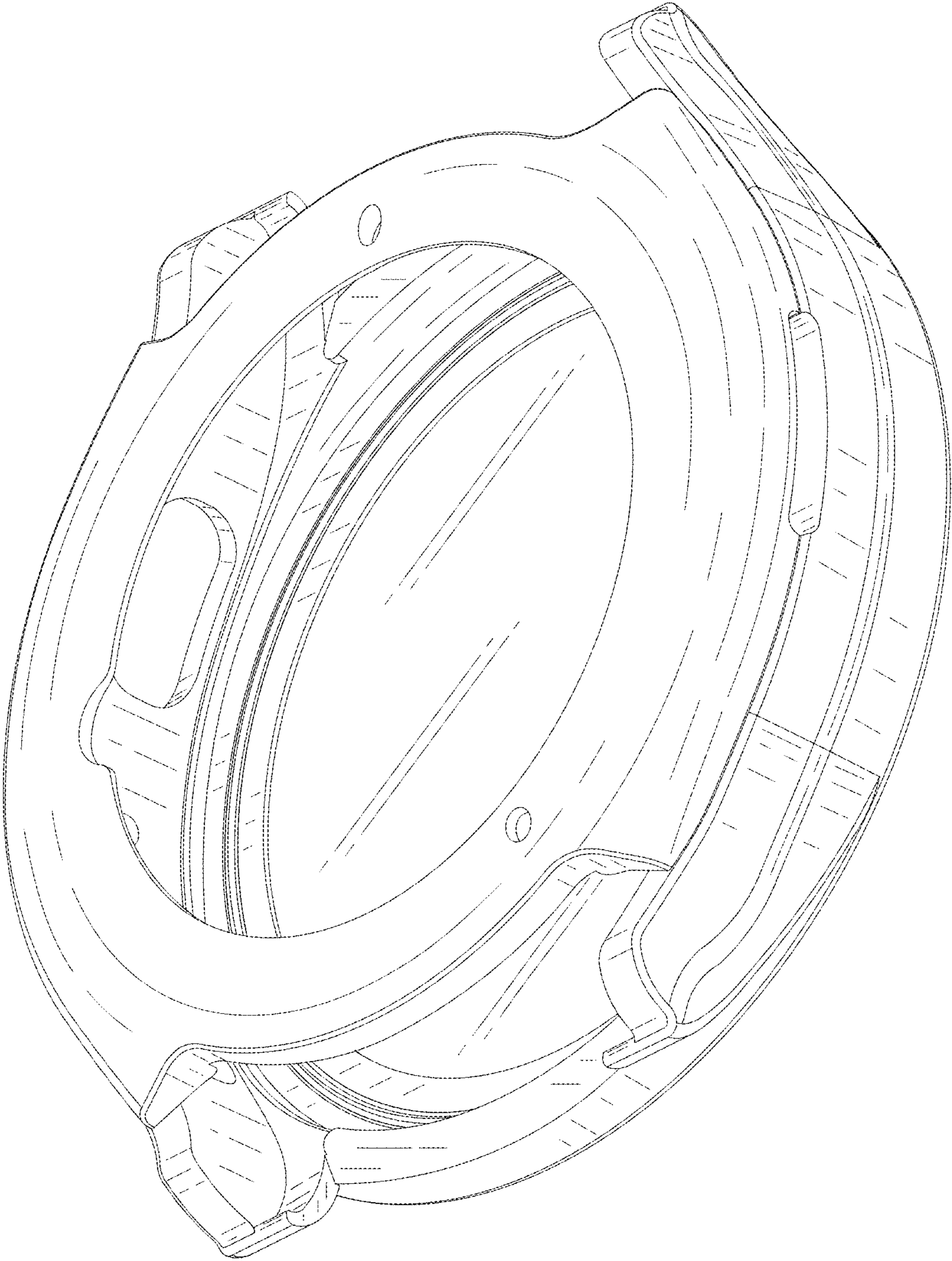

FIG. 12

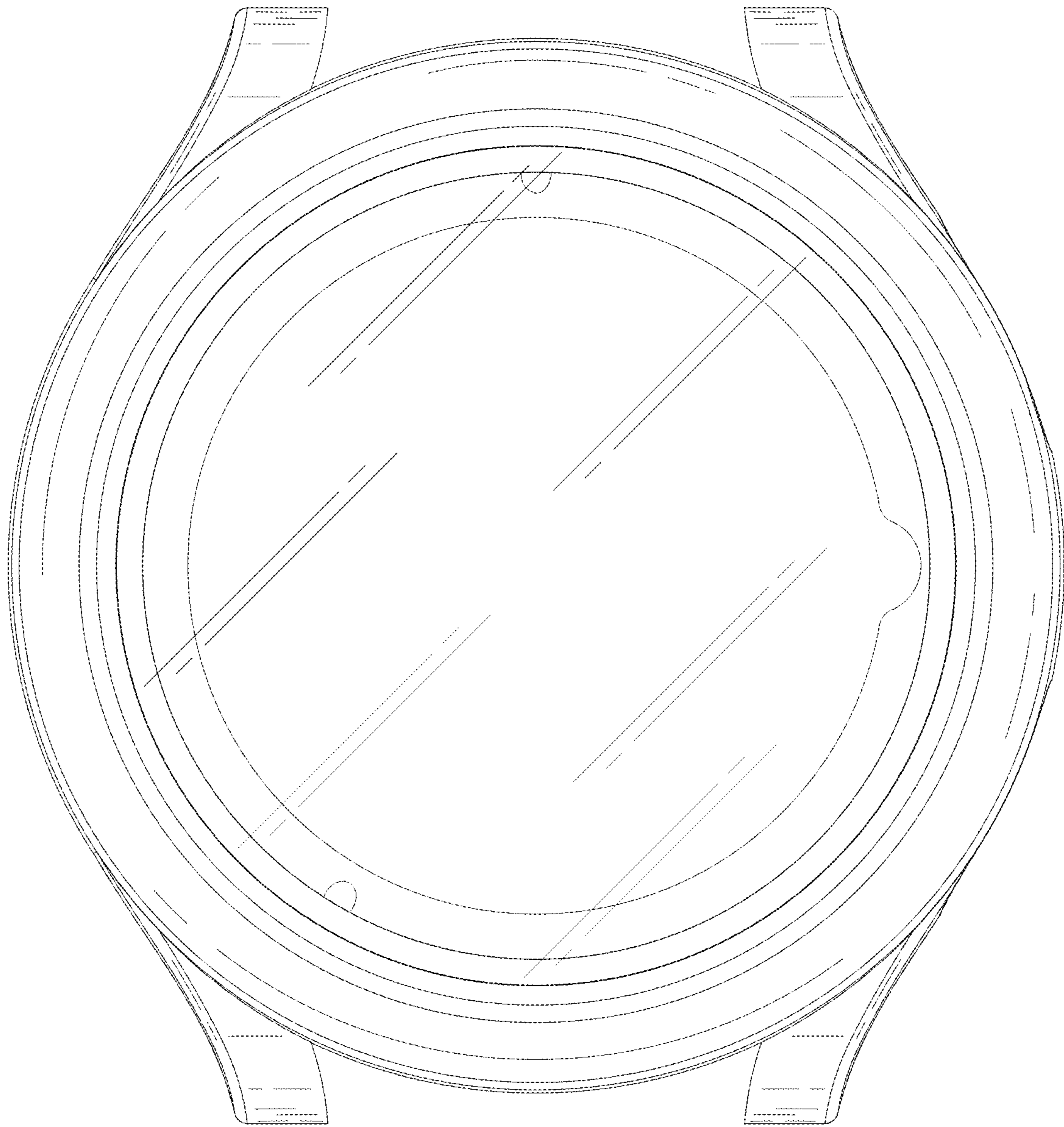

FIG. 13



FIG. 14

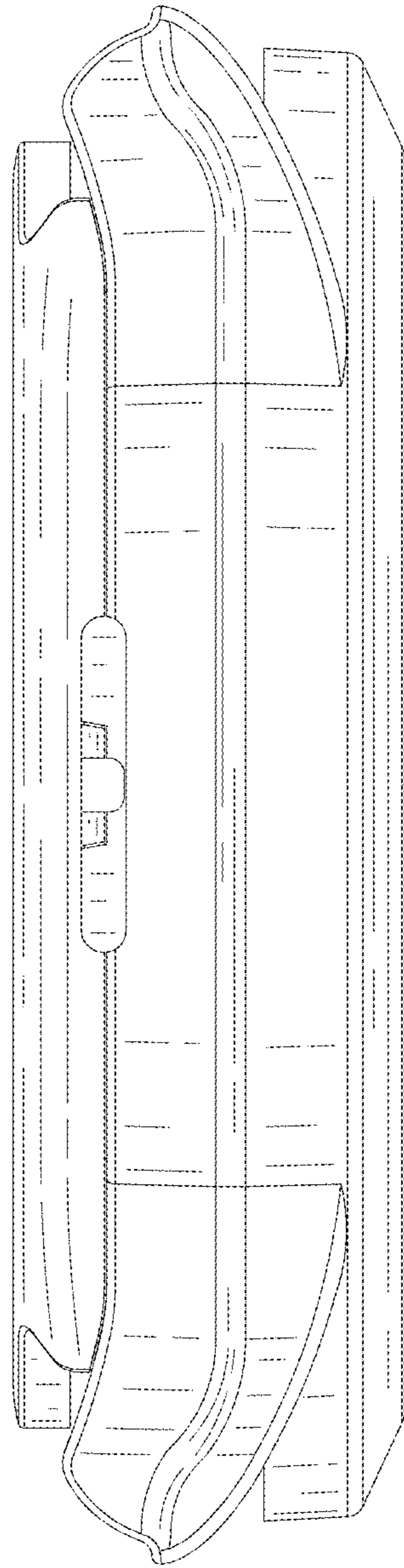

FIG. 15

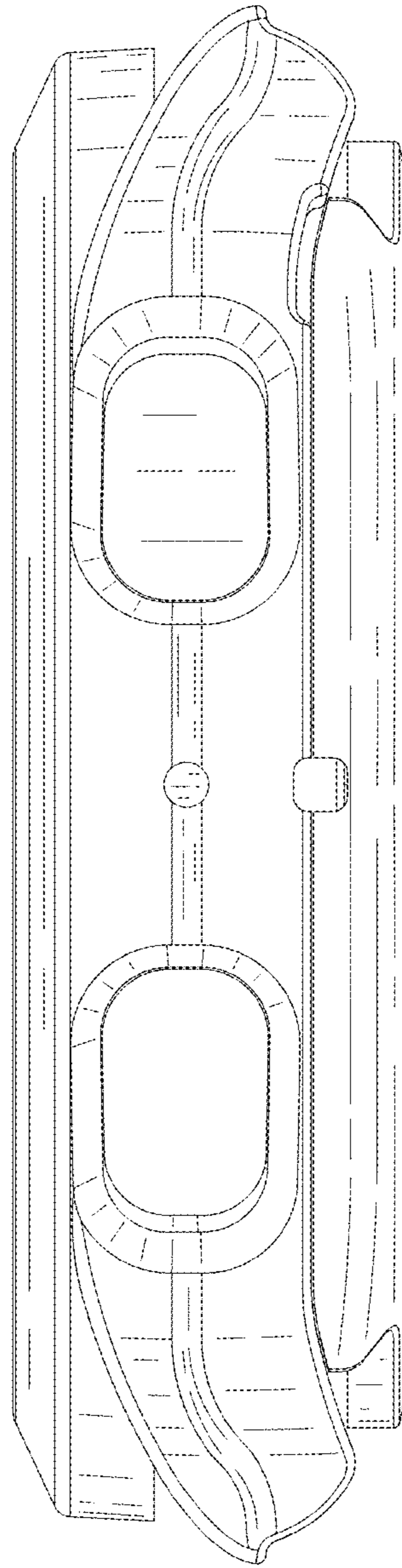

FIG. 16

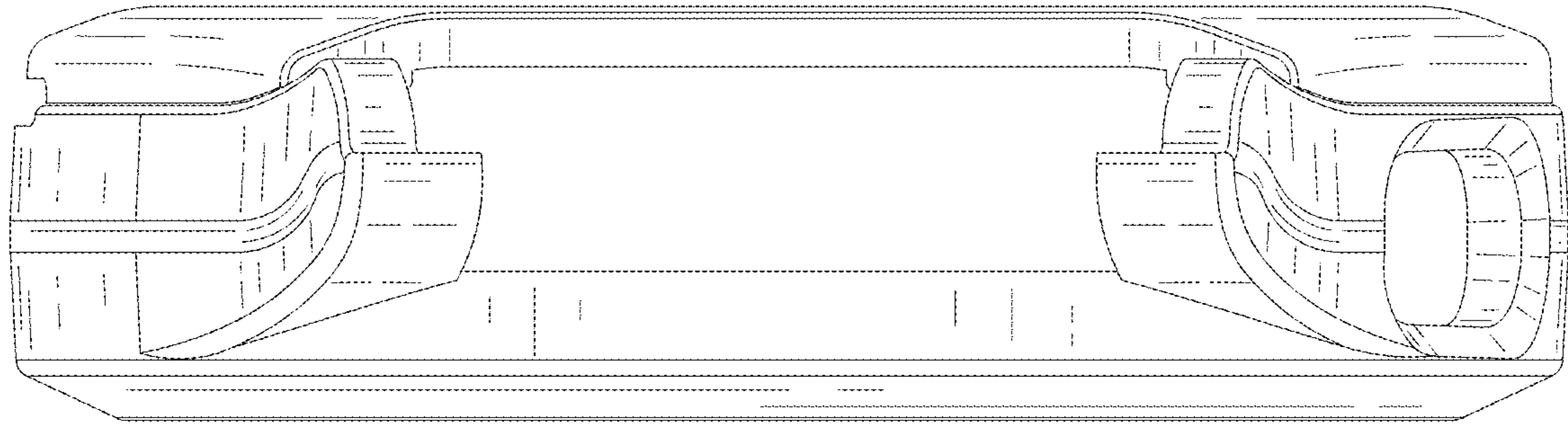

FIG. 17

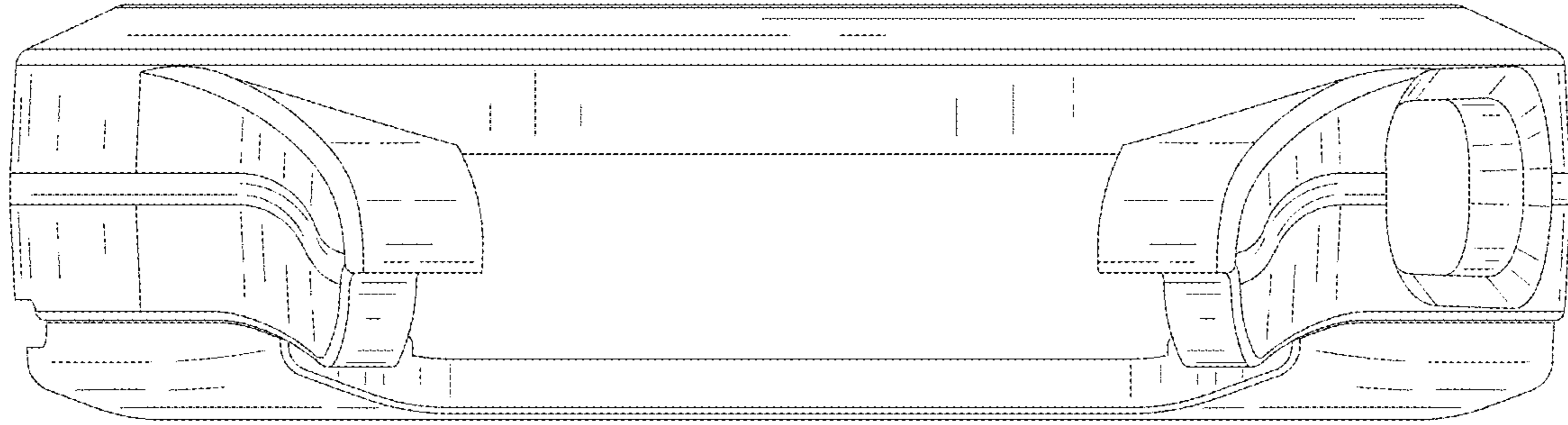

FIG. 18

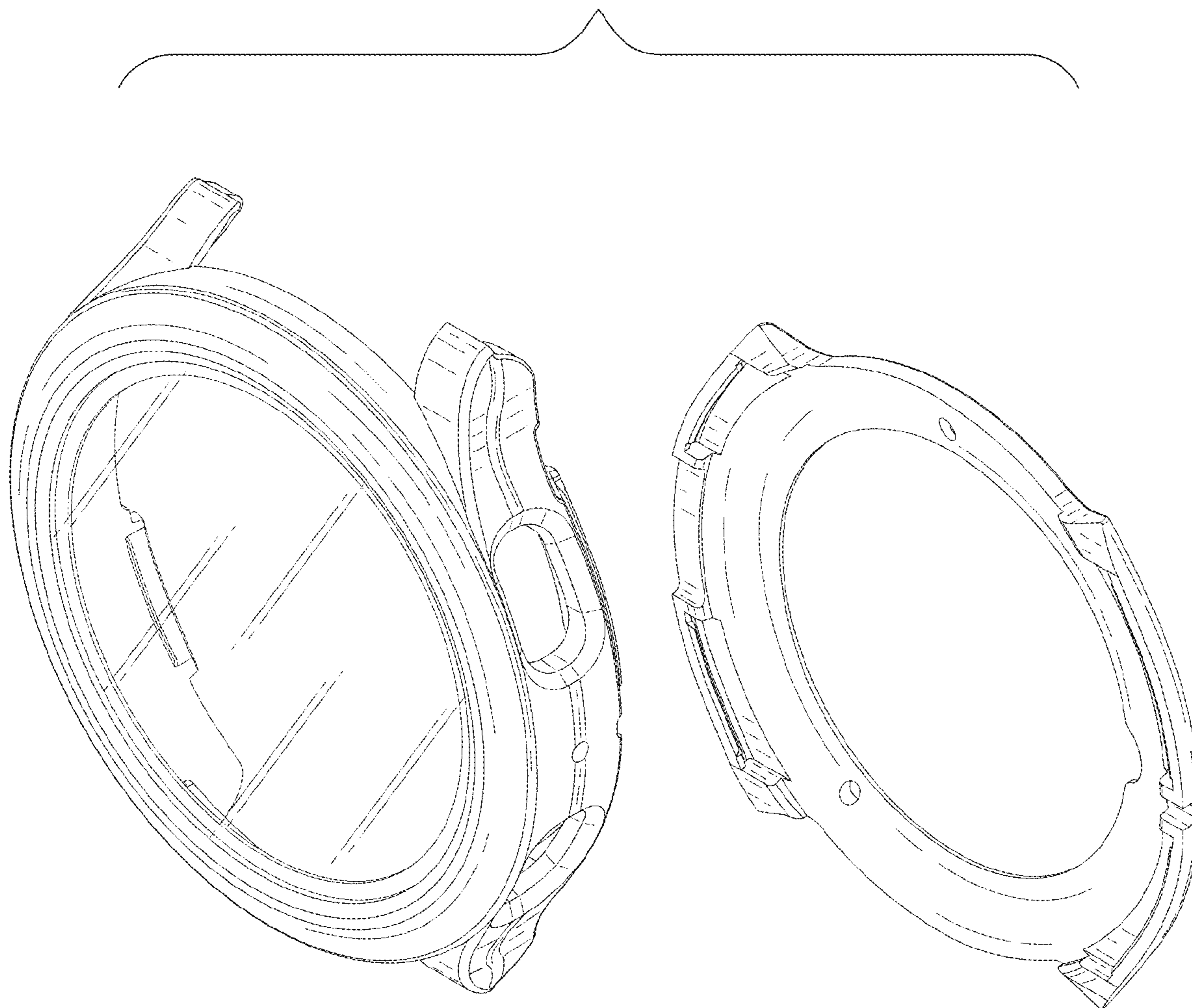

FIG. 19

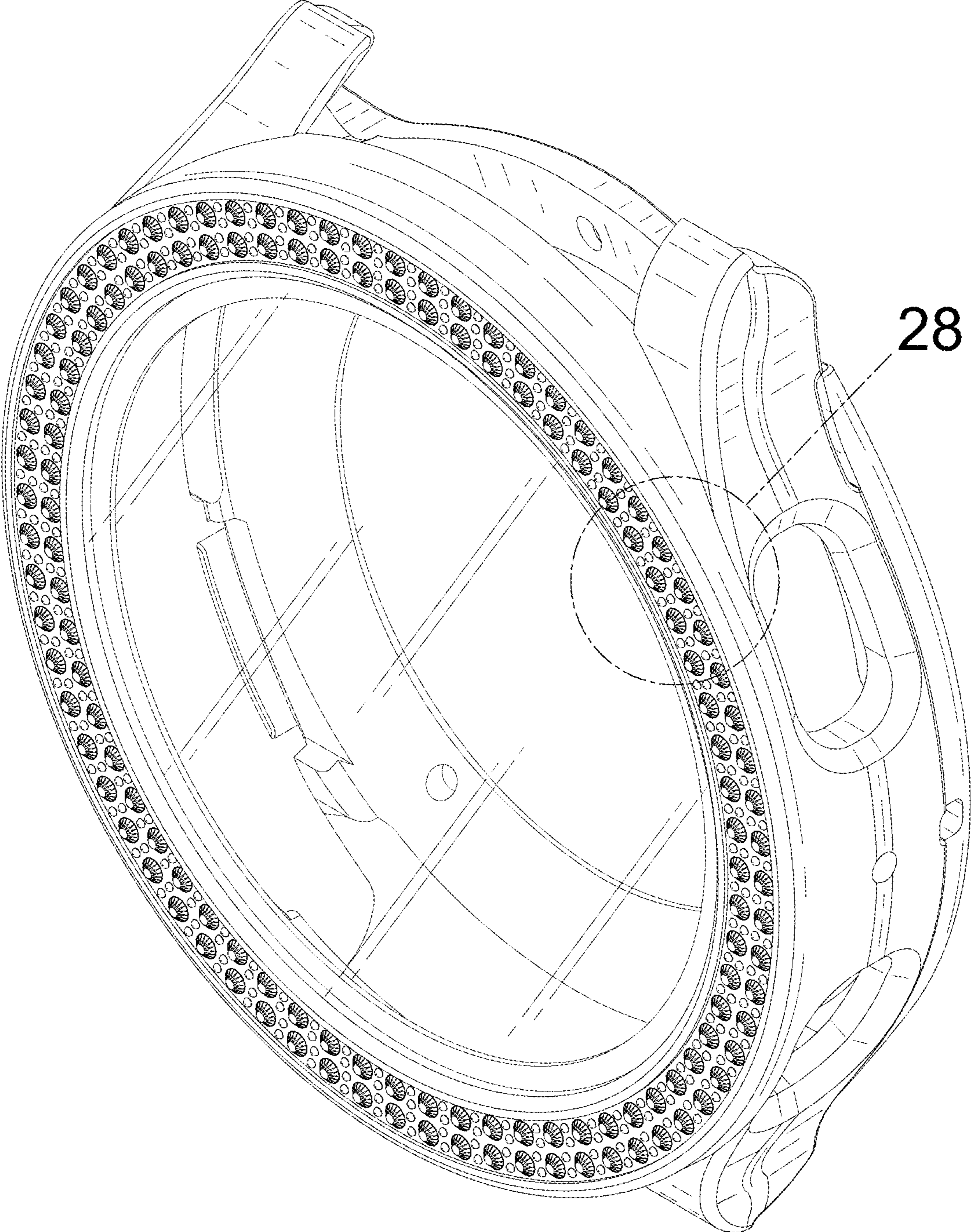

FIG. 20

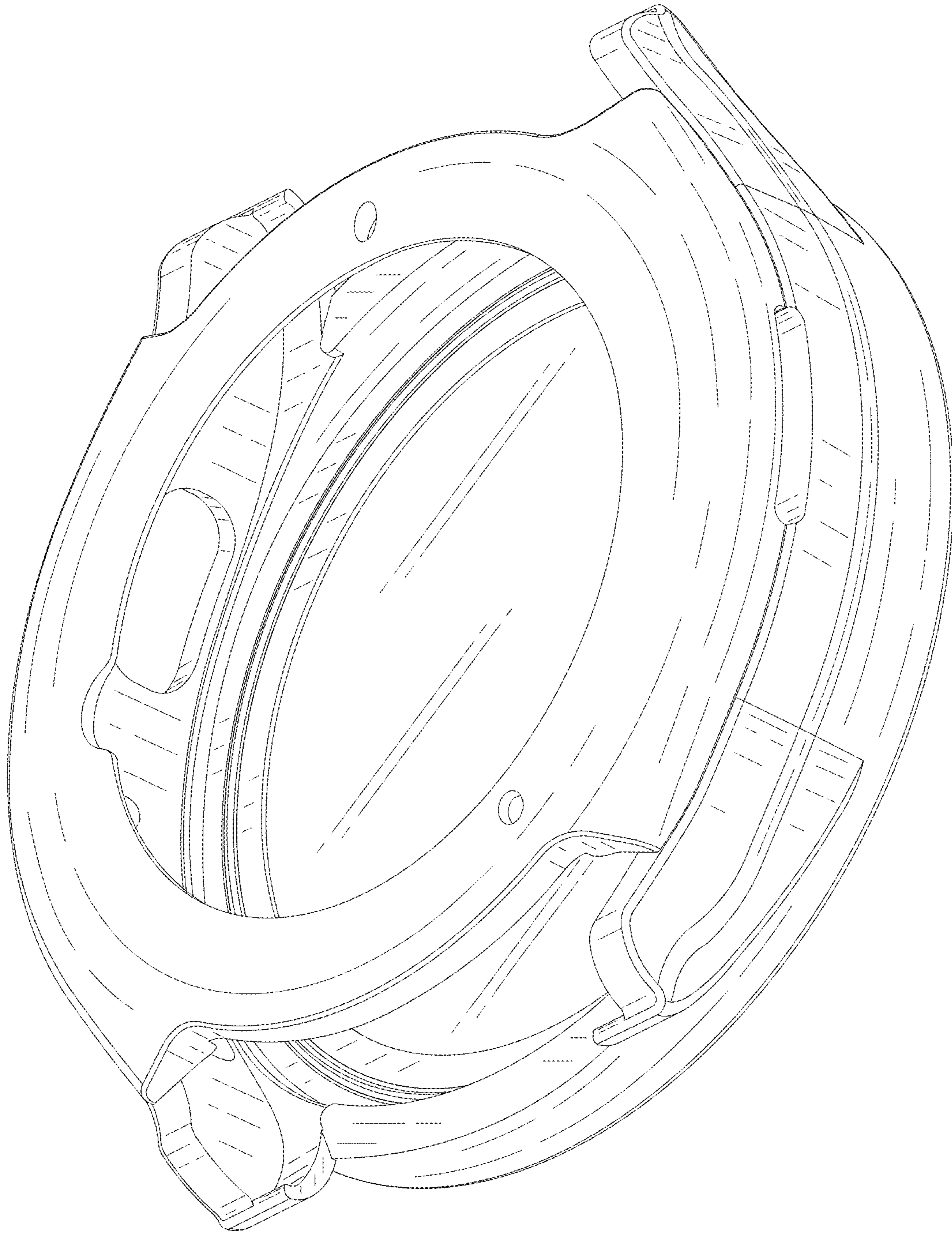

FIG. 21

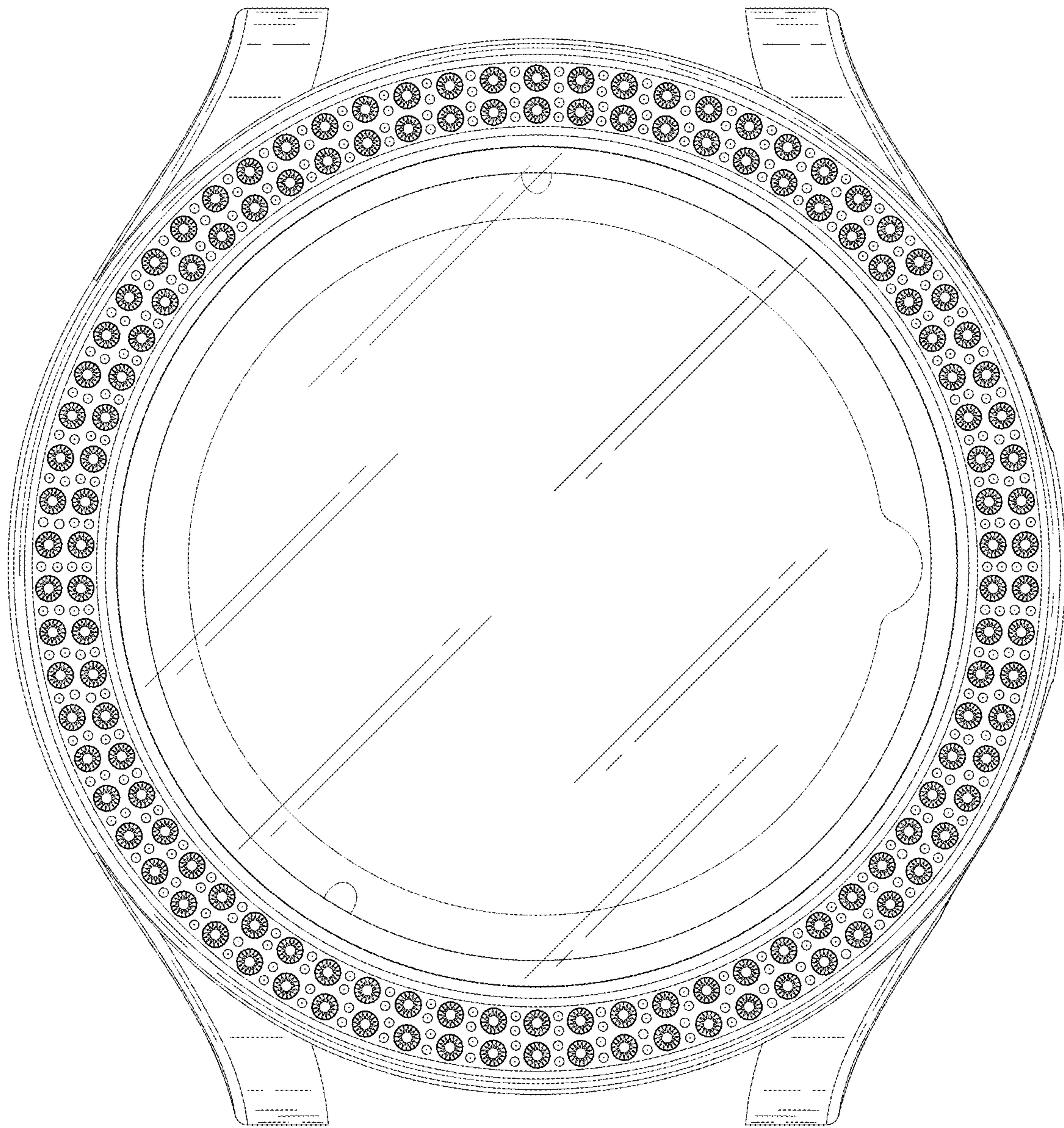

FIG. 22

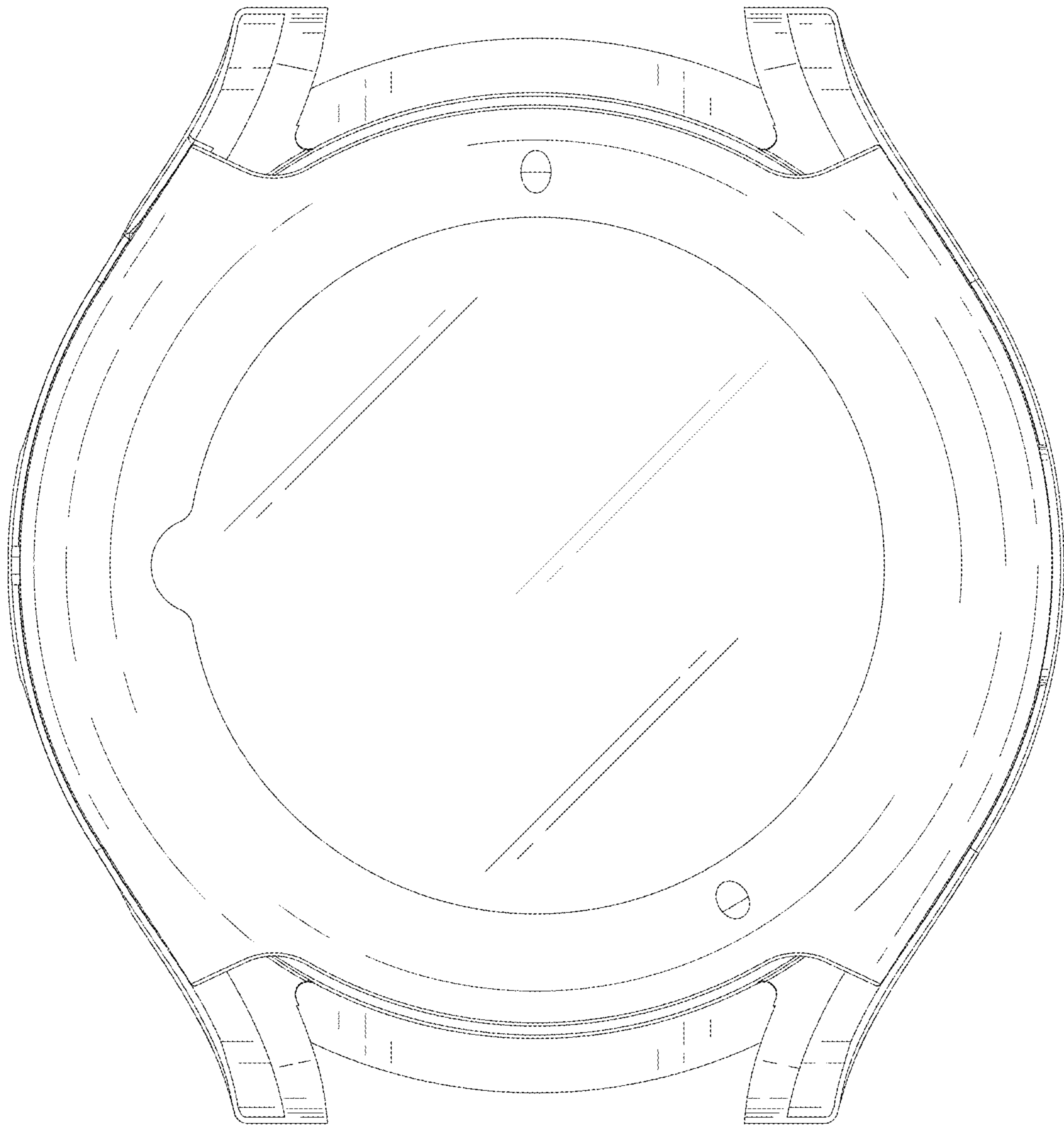

FIG. 23

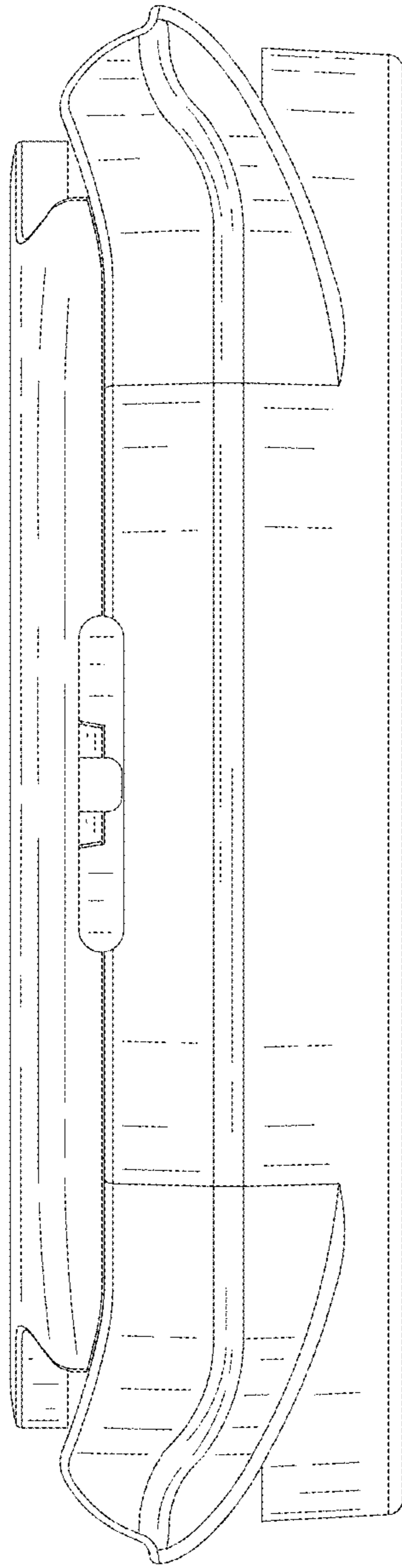

FIG. 24

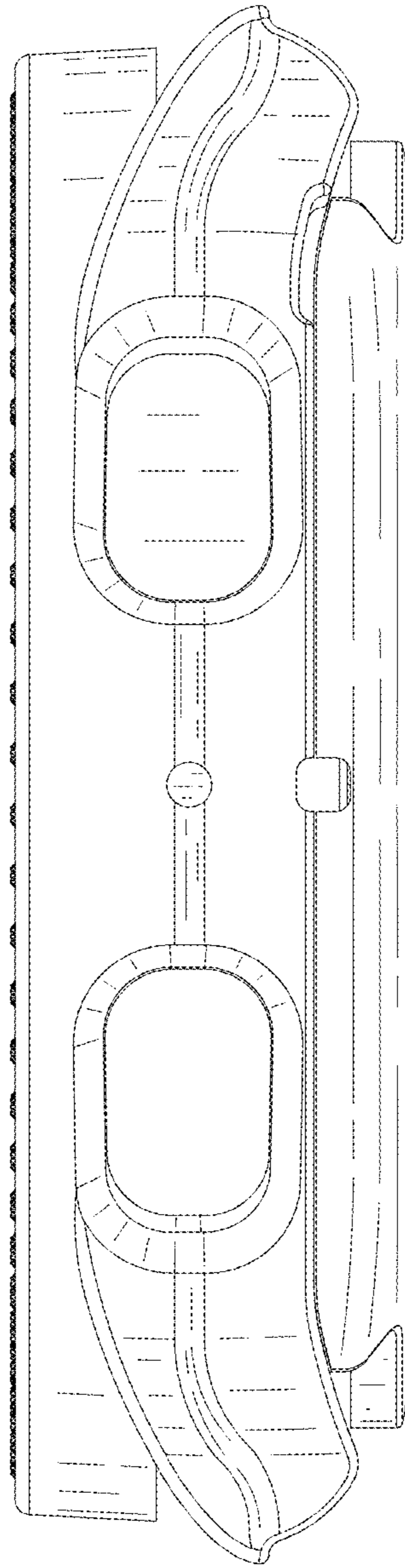

FIG. 25

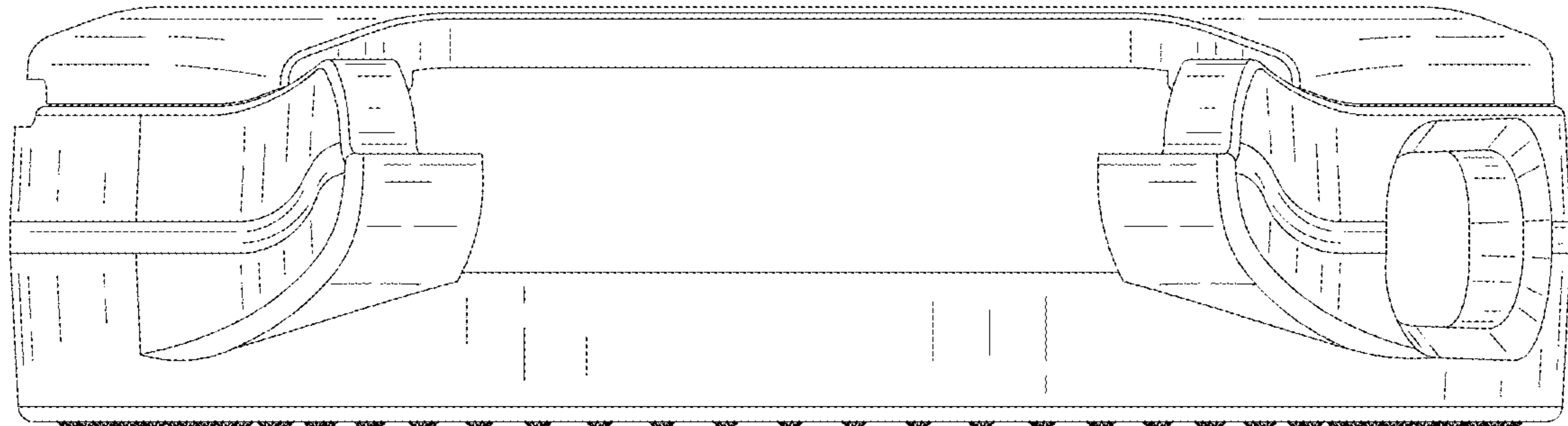

FIG. 26

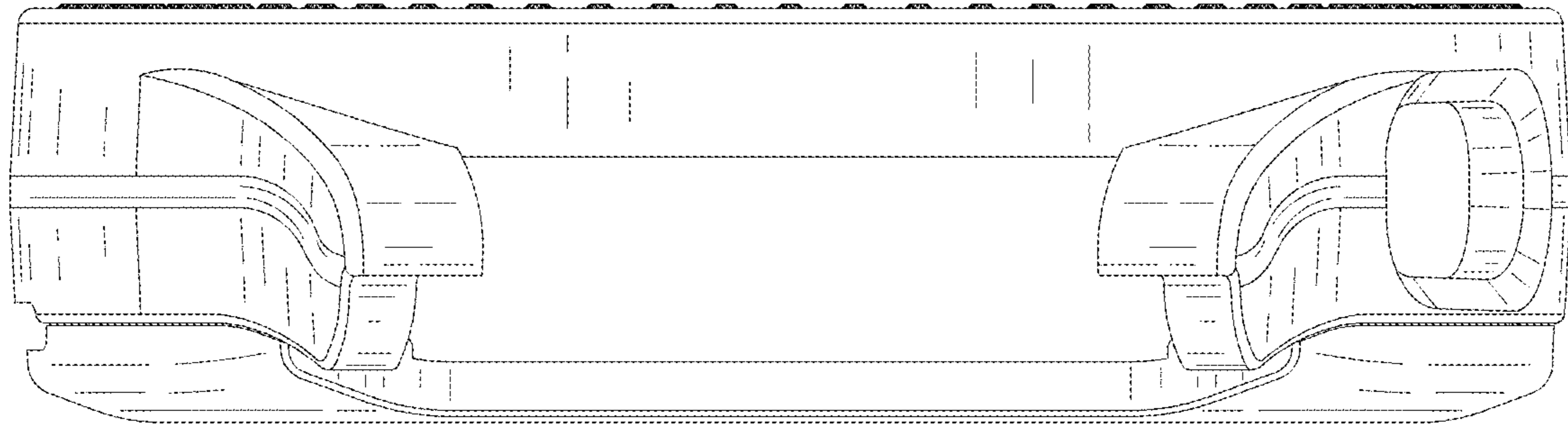

FIG. 27

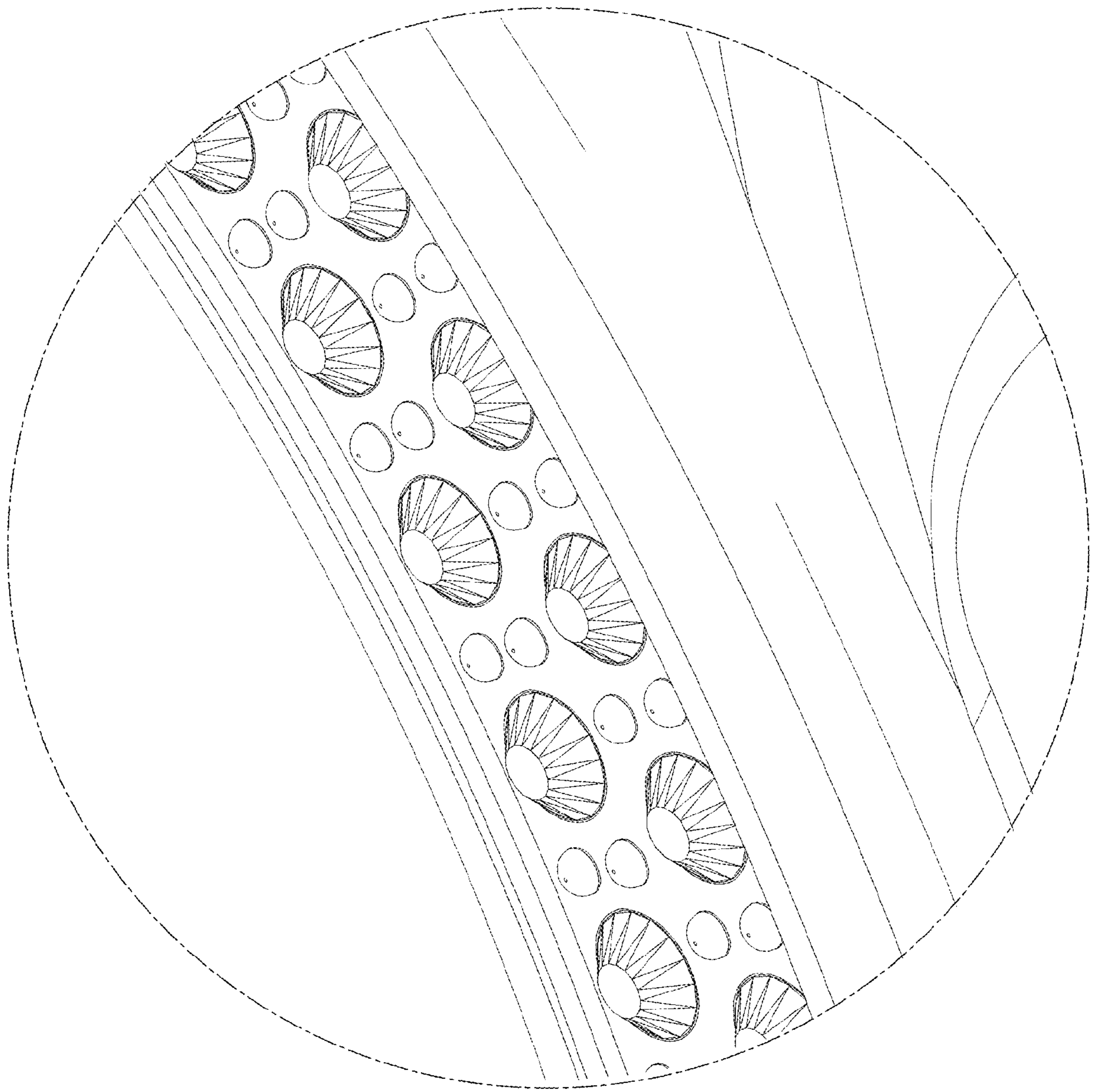

FIG. 28

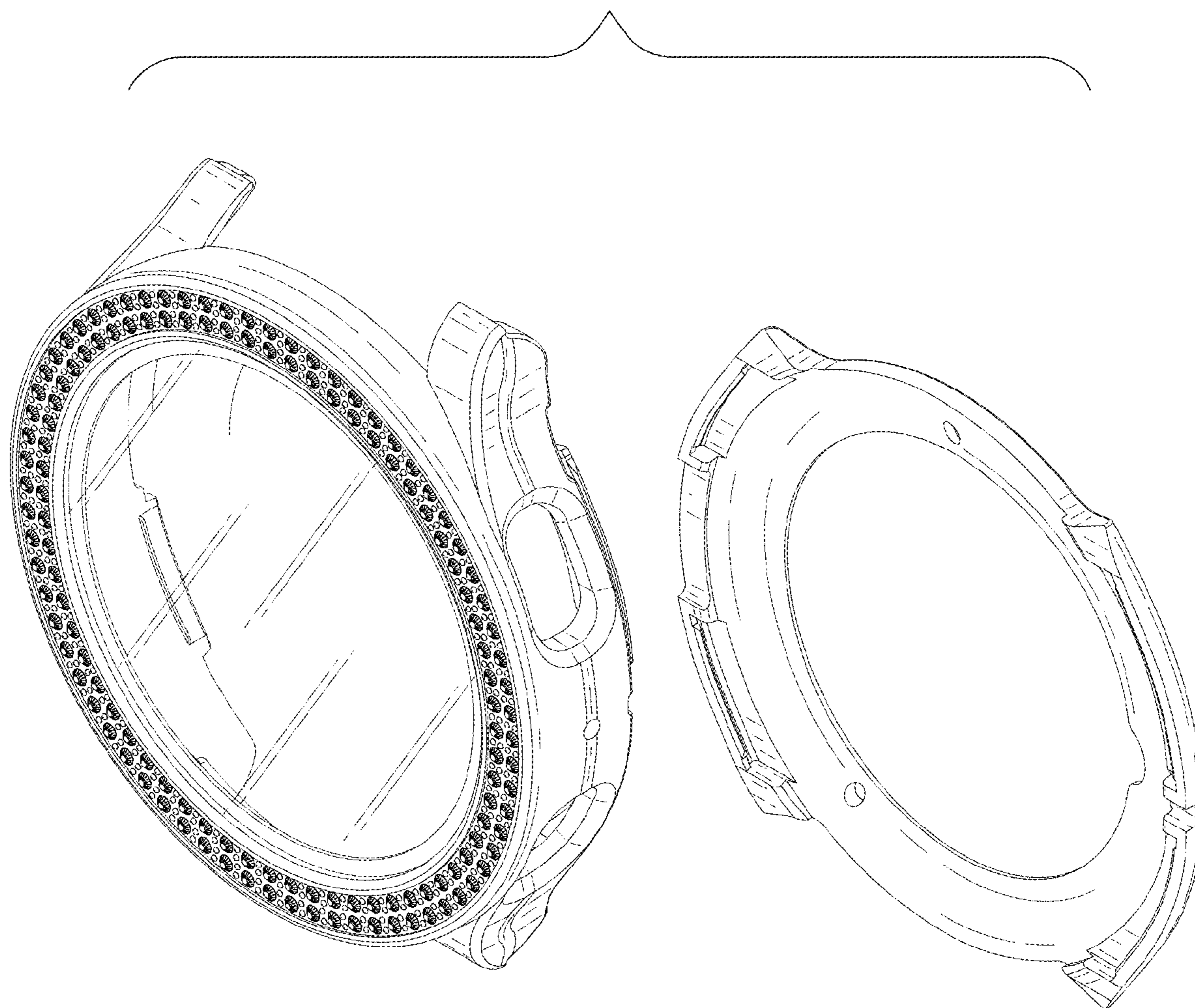

FIG. 29