



US00D980054S

(12) **United States Design Patent** (10) **Patent No.:** **US D980,054 S**
You (45) **Date of Patent:** **** Mar. 7, 2023**

(54) **NUT**
(71) Applicant: **NINGBO LANTINGJIXU TECHNOLOGY CO., LTD., Ningbo (CN)**
(72) Inventor: **Guanghai You, Ningbo (CN)**
(73) Assignee: **NINGBO LANTINGJIXU TECHNOLOGY CO., LTD., Ningbo (CN)**
(**) Term: **15 Years**
(21) Appl. No.: **29/851,544**
(22) Filed: **Aug. 30, 2022**
(51) **LOC (14) Cl.** **08-08**
(52) **U.S. Cl.**
USPC **D8/397**
(58) **Field of Classification Search**
USPC D8/397, 382, 349, 399, 387; 411/427, 411/374, 366.1, 376.2, 84, 446, 399, 490, 411/455
CPC F16B 37/14; B29C 66/474; B29C 66/9513
See application file for complete search history.

D713,705 S * 9/2014 Mina D8/68
9,157,464 B2 * 10/2015 Ellis B32B 3/06
D748,972 S * 2/2016 Primeau D8/397
D789,187 S * 6/2017 Vitou D8/382
D795,398 S * 8/2017 Decaria D23/260
D796,563 S * 9/2017 Sharivker D15/139
D799,315 S * 10/2017 May D8/397
D818,811 S * 5/2018 Hattori
D879,249 S * 3/2020 Glaser D23/233
D909,856 S * 2/2021 Cobzaru D8/387
D909,857 S * 2/2021 Cobzaru D8/387
D920,774 S * 6/2021 Cobzaru D8/387
D935,877 S * 11/2021 Cobzaru D8/387
D959,255 S * 8/2022 Schramm et al.
D964,474 S * 9/2022 Brous D21/455

(Continued)

Primary Examiner — Cynthia R Underwood
(74) *Attorney, Agent, or Firm* — Daniel M. Cohn;
Howard M. Cohn

(57) **CLAIM**

The ornamental design for a nut, as shown and described.

DESCRIPTION

FIG. 1 is a perspective view of a nut showing my new design;
FIG. 2 is another perspective view thereof;
FIG. 3 is a front elevational view thereof;
FIG. 4 is a rear elevational view thereof;
FIG. 5 is a left side elevational view thereof;
FIG. 6 is a right side elevational view thereof;
FIG. 7 is a top plan view thereof;
FIG. 8 is a bottom plan view thereof; and,
FIG. 9 is a perspective view of the nut where the nut is in a configuration of use.
The broken lines in the drawings depict portions of the nut that form no part of the claimed design. The broken lines in FIG. 9 showing the nut depict environment and form no part of the claimed design.

1 Claim, 9 Drawing Sheets

(56) **References Cited**
U.S. PATENT DOCUMENTS
D157,484 S * 2/1950 Gade D12/213
D254,232 S * 2/1980 Ono D8/397
D311,131 S * 10/1990 Saito D8/397
D320,162 S * 9/1991 Sorenson D8/387
D323,287 S * 1/1992 Brunetti D8/385
D323,288 S * 1/1992 Brunetti D9/555
5,082,405 A * 1/1992 Witten B29C 66/474
411/258
5,857,818 A * 1/1999 Bias, Sr. F16B 37/14
411/429
D704,543 S * 5/2014 Kuhmichel D8/397

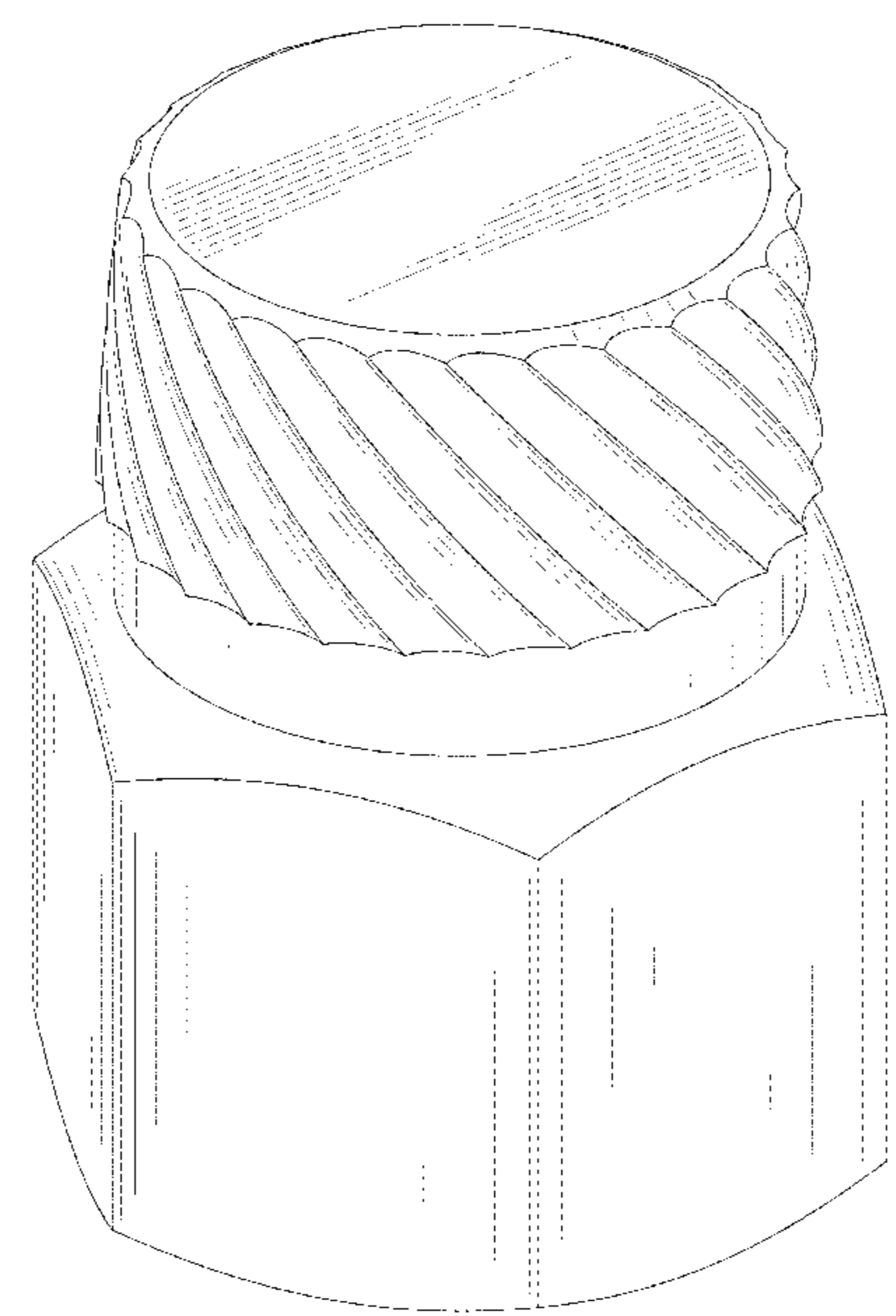

(56)

References Cited

U.S. PATENT DOCUMENTS

2006/0171794 A1* 8/2006 Ordonio F16B 37/14
411/369
2022/0136554 A1* 5/2022 Eckhard B29C 66/9513
411/171

* cited by examiner

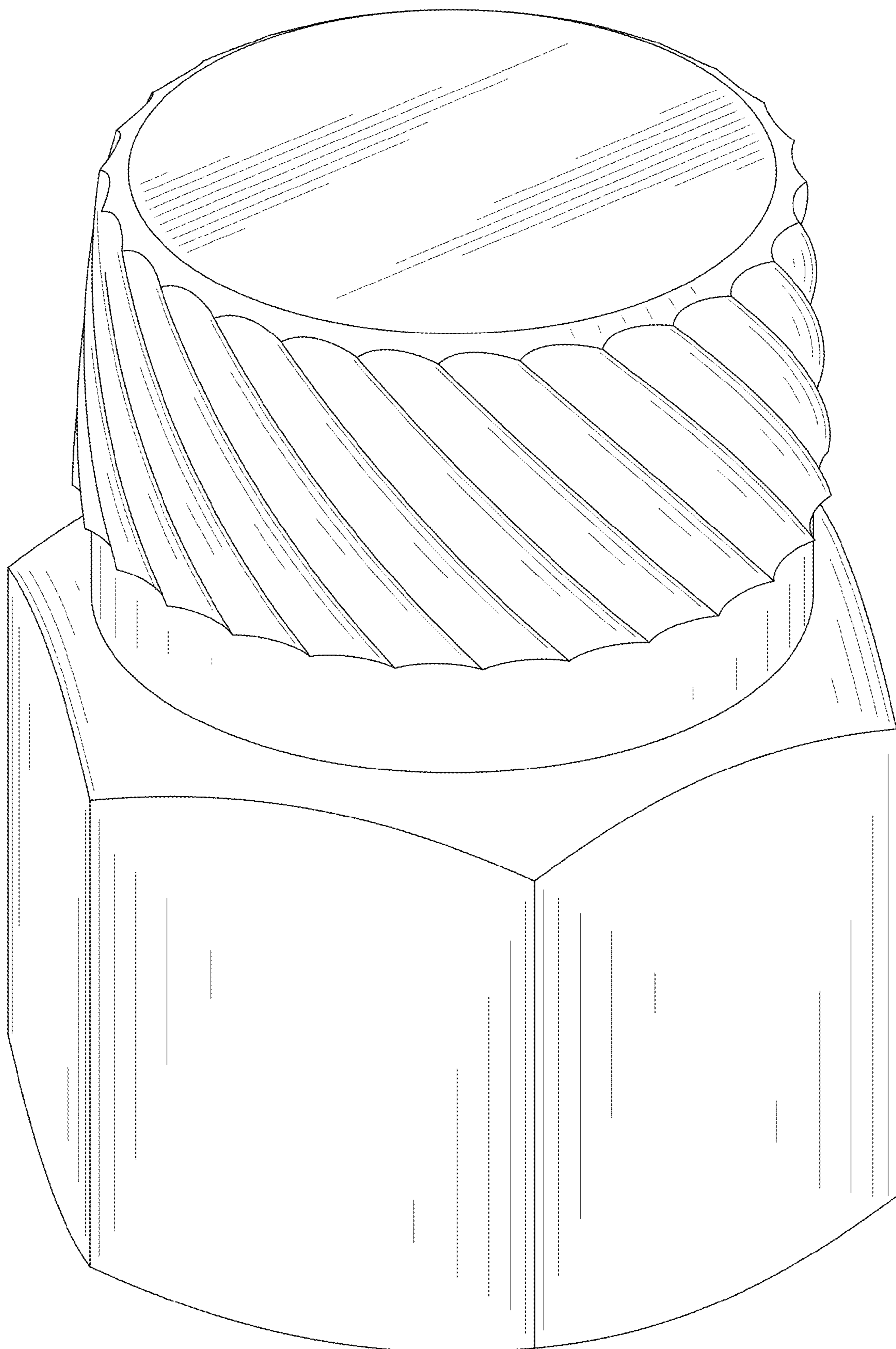

FIG. 1

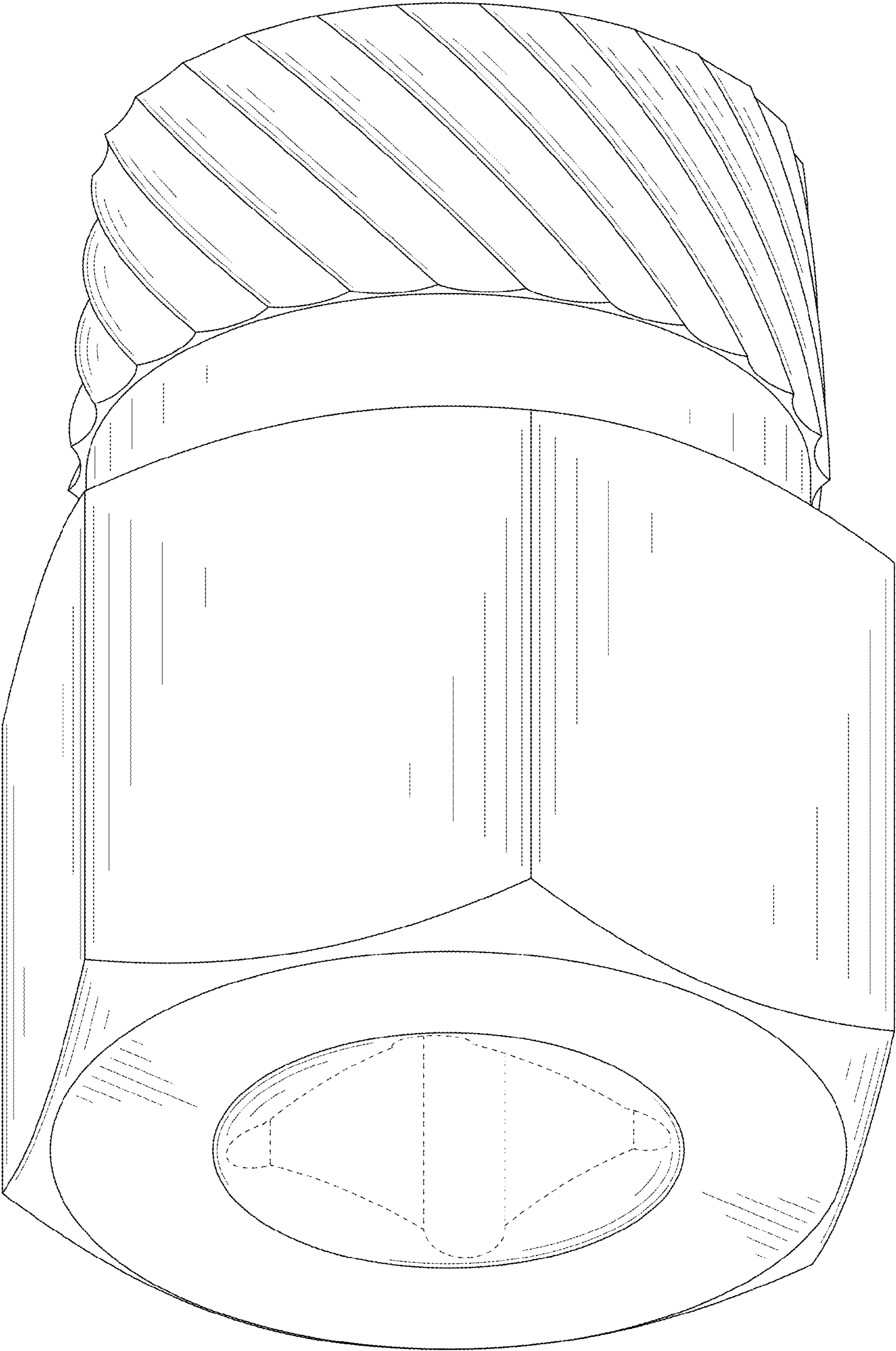

FIG. 2

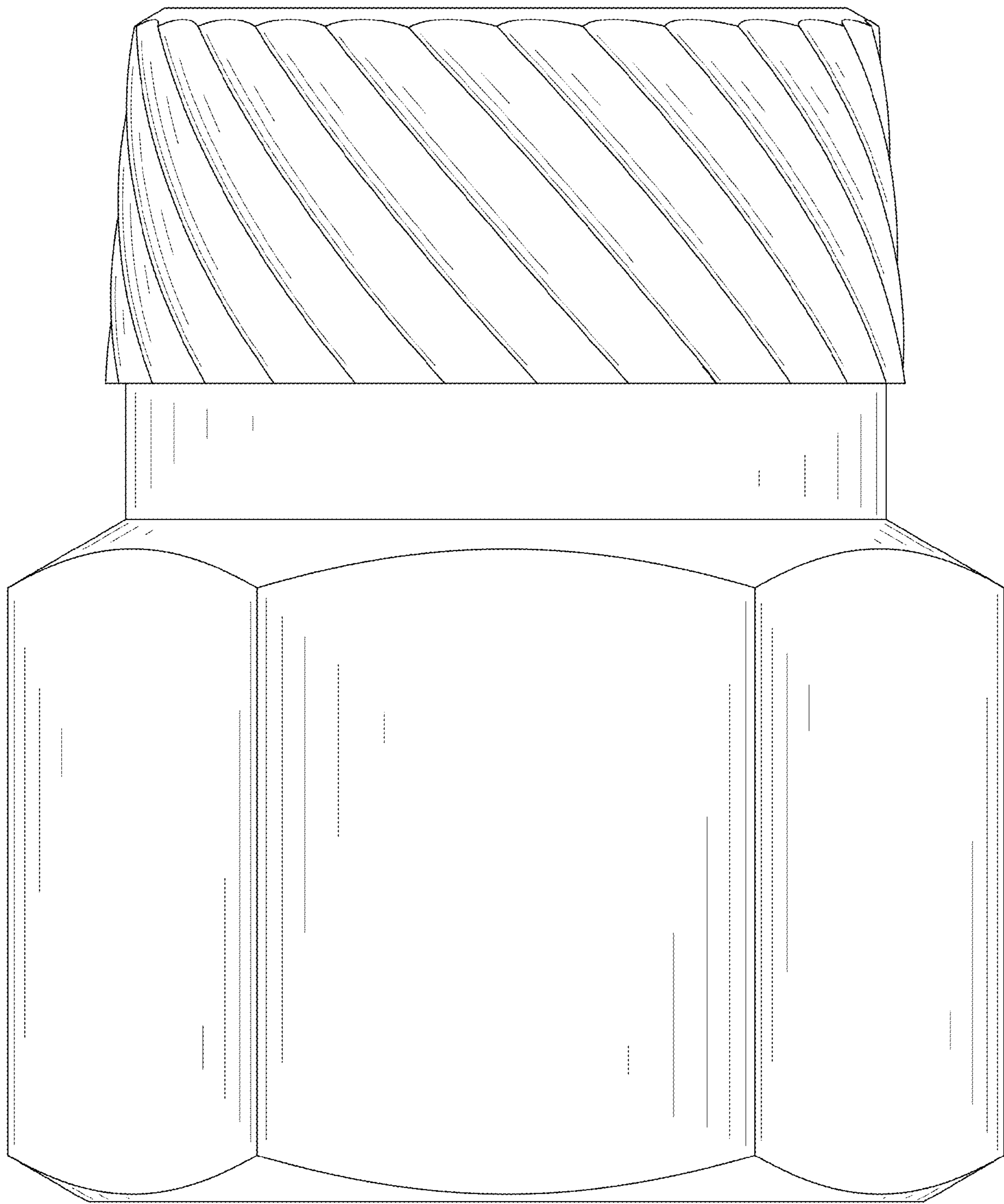

FIG. 3

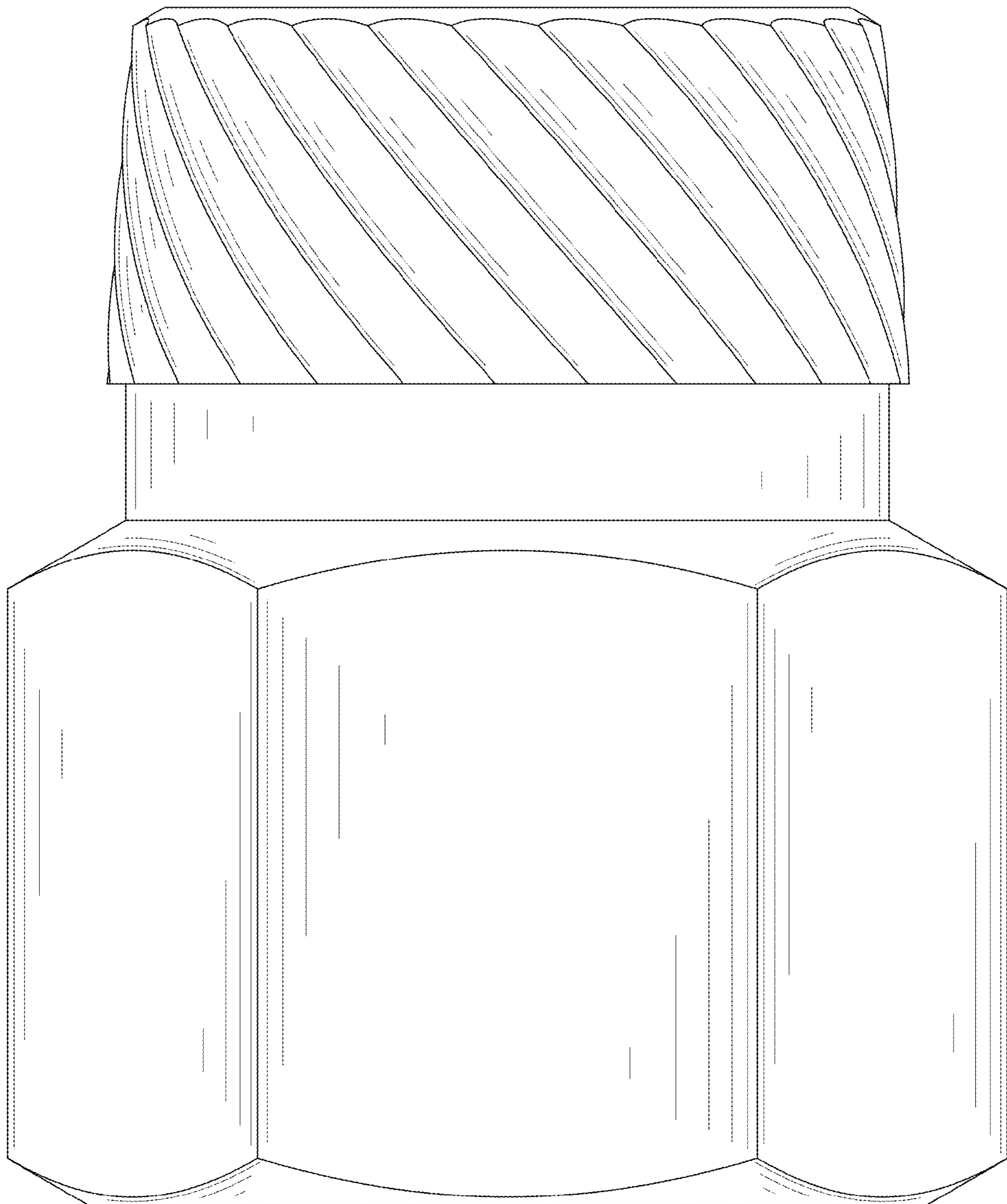

FIG. 4

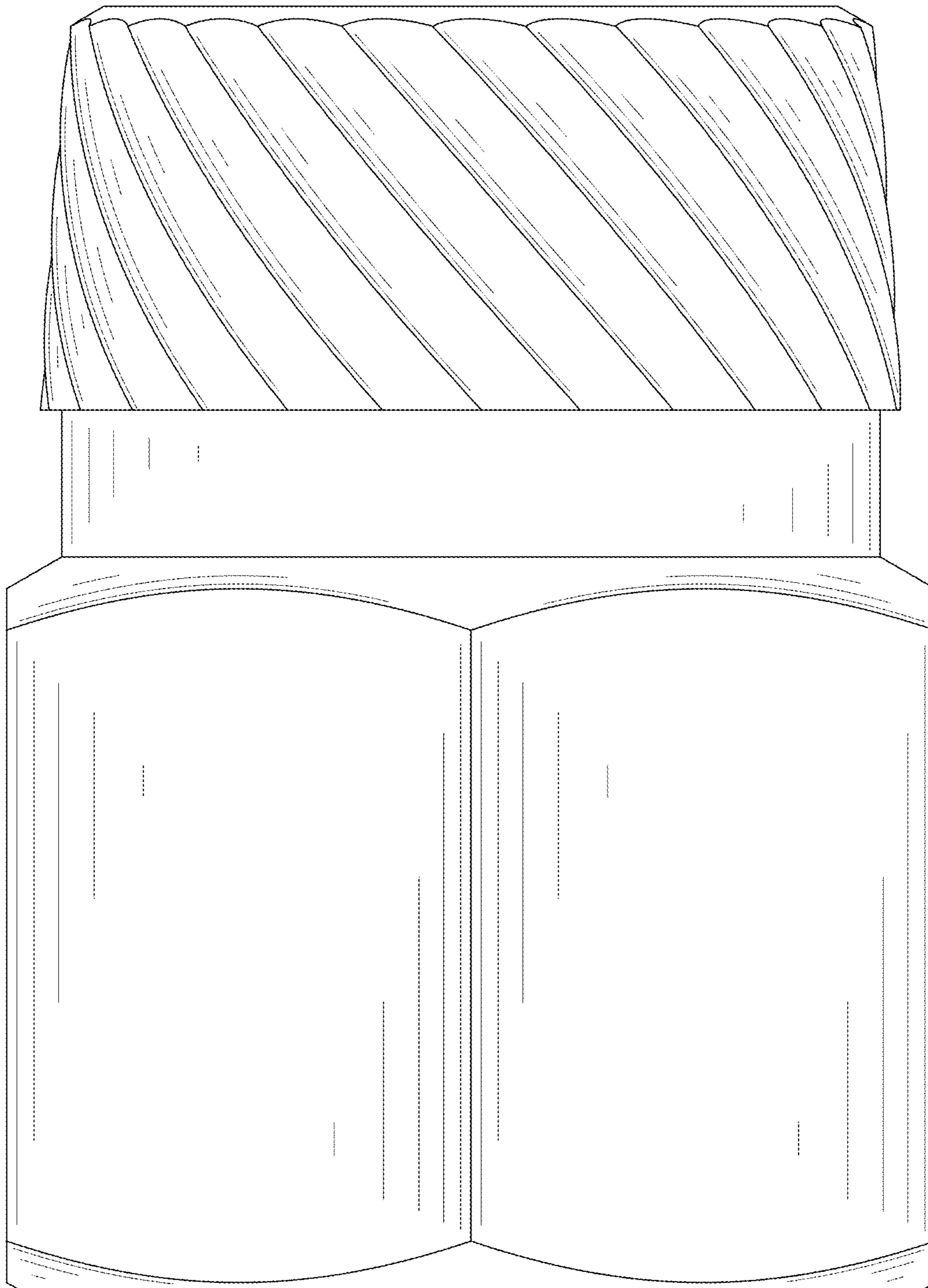

FIG. 5

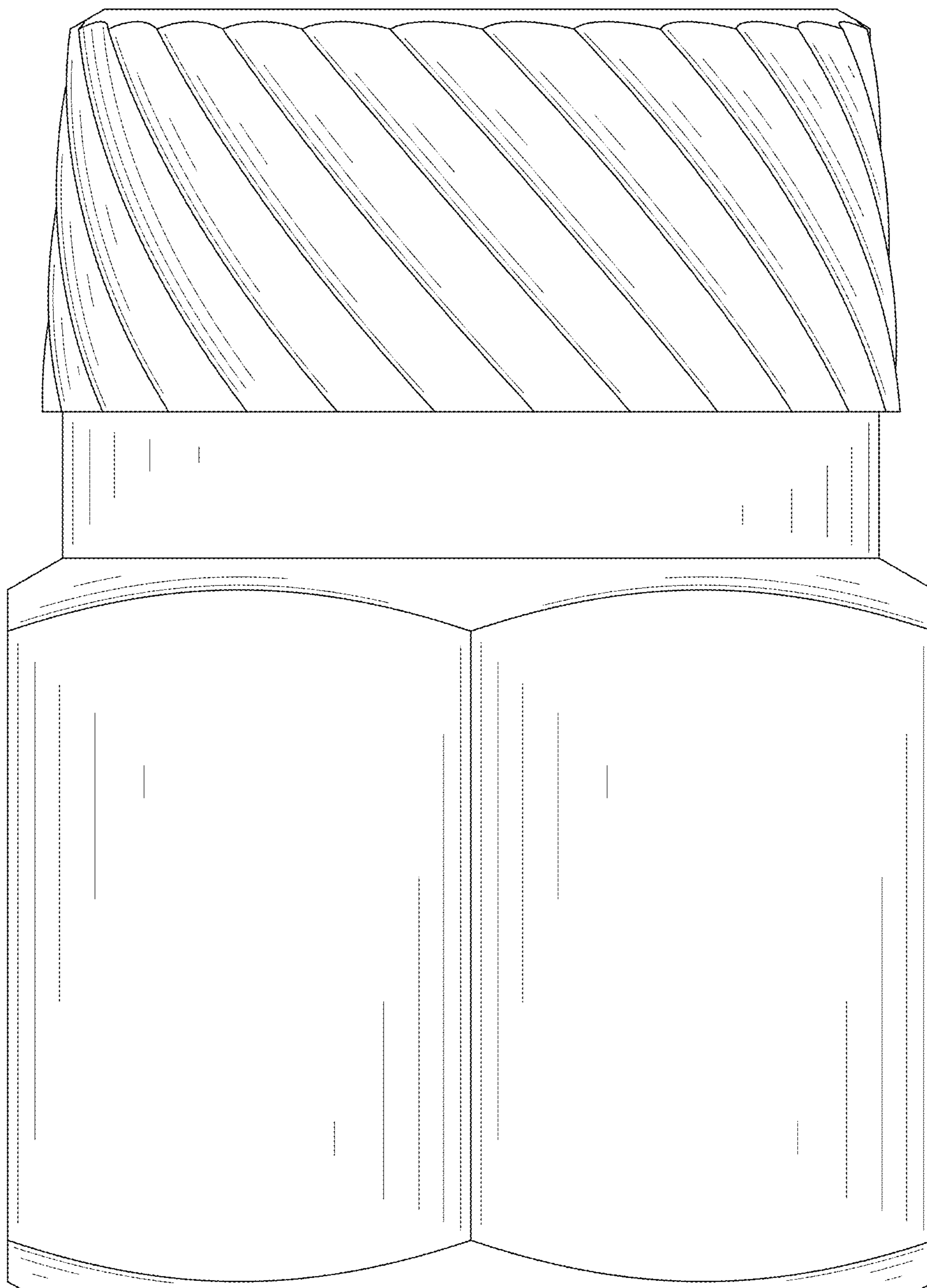

FIG. 6

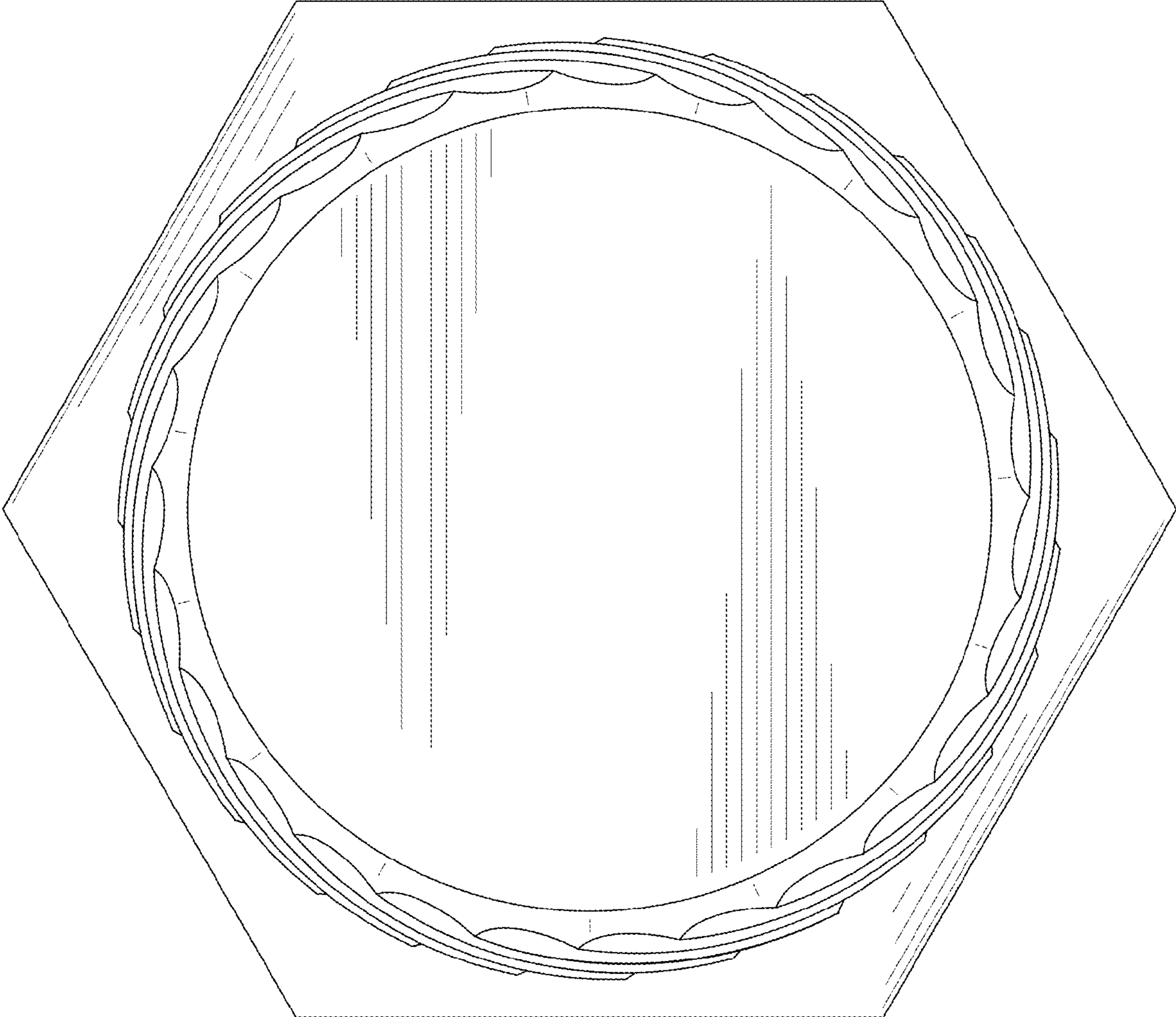

FIG. 7

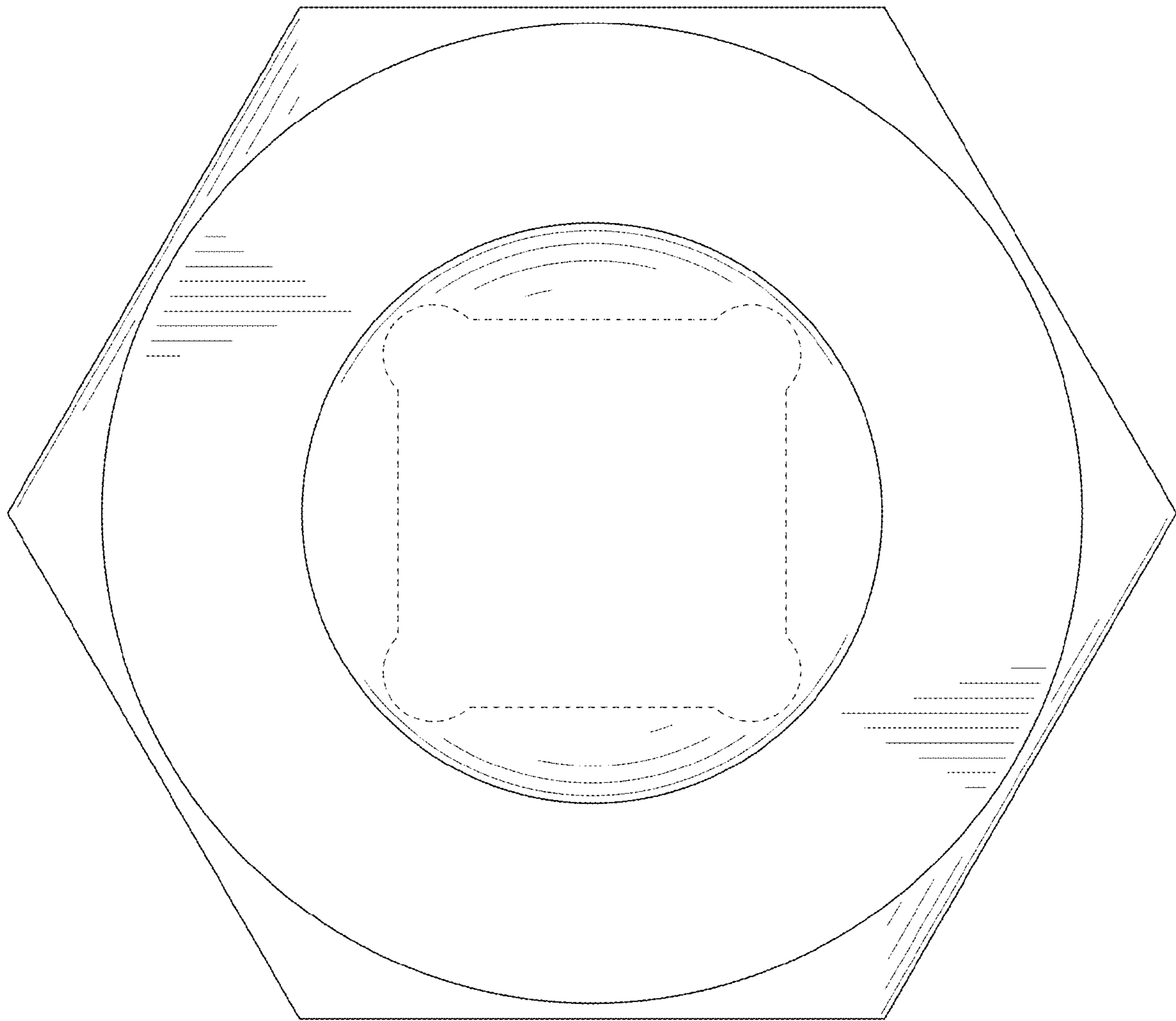

FIG. 8

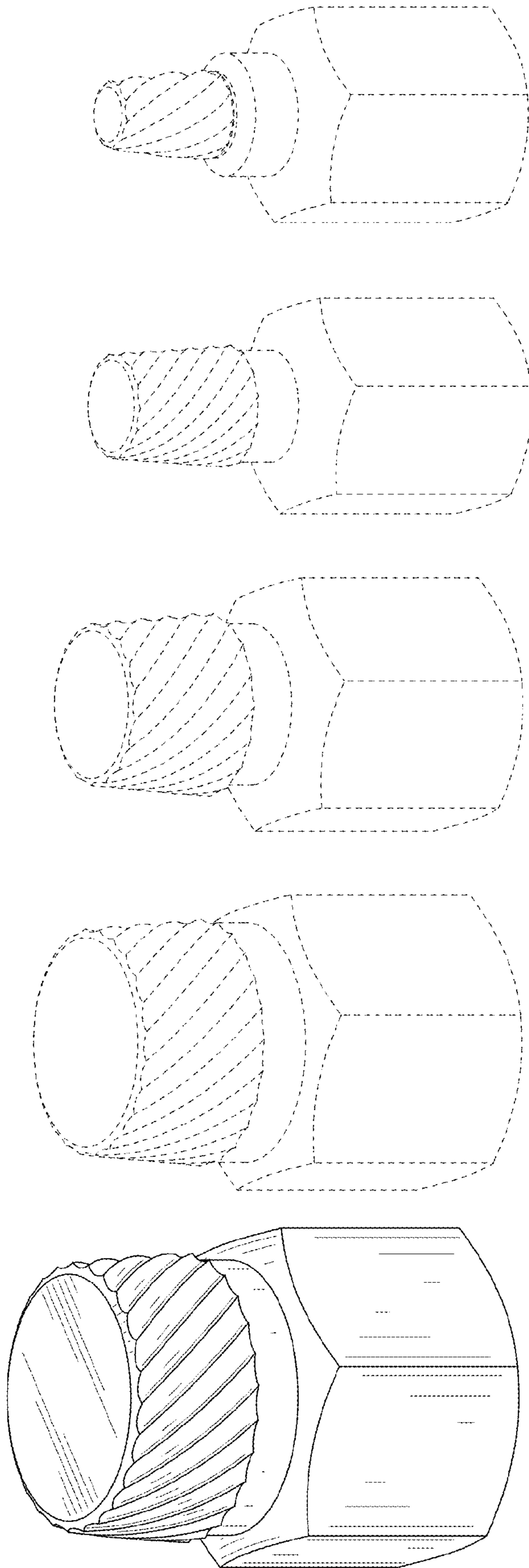

FIG. 9