



US00D980027S

(12) **United States Design Patent**  
**Peng**

(10) **Patent No.:** **US D980,027 S**  
(45) **Date of Patent:** **\*\* Mar. 7, 2023**

(54) **SCISSORS**  
(71) Applicant: **Yangjiang Gangfu Industrial Co., Ltd.**, Guangdong (CN)  
(72) Inventor: **Yuegui Peng**, Guangdong (CN)  
(73) Assignee: **YANGJIANG GANGFU INDUSTRIAL CO., LTD.**, Yangjiang (CN)

D402,174 S \* 12/1998 Gstalder ..... D8/57  
6,158,128 A \* 12/2000 Huff ..... B26B 13/06  
30/233  
D472,121 S \* 3/2003 Wolff ..... D8/57  
D543,817 S \* 6/2007 McLean ..... D8/57  
D677,538 S \* 3/2013 Hasegawa ..... D8/57  
D677,539 S \* 3/2013 Roberts ..... D8/57  
D684,027 S \* 6/2013 Roberts ..... D8/57  
D701,738 S \* 4/2014 Forsell ..... D8/57  
D739,197 S \* 9/2015 Farnworth ..... D8/57  
D829,521 S \* 10/2018 Constantine ..... D8/57  
D889,226 S \* 7/2020 Wu ..... D8/57

(\*\*) Term: **15 Years**

\* cited by examiner

(21) Appl. No.: **29/788,701**

*Primary Examiner* — Deanna L Pratt

(22) Filed: **Jul. 20, 2021**

(74) *Attorney, Agent, or Firm* — Shimokaji IP

(30) **Foreign Application Priority Data**

(57) **CLAIM**

The ornamental design for scissors, as shown and described.

Jun. 29, 2021 (CN) ..... 202130405783.2

**DESCRIPTION**

(51) **LOC (14) Cl.** ..... **08-03**

(52) **U.S. Cl.**  
USPC ..... **D8/57**

(58) **Field of Classification Search**  
USPC ..... D8/51–58, 4–5, 14  
CPC ..... B26B 13/00; B26B 13/02; B26B 13/12  
See application file for complete search history.

FIG. 1 is a front elevation view of scissors showing our design;  
FIG. 2 is a rear elevational view thereof;  
FIG. 3 is a left side elevational view thereof;  
FIG. 4 is a right side elevational view thereof;  
FIG. 5 is a top plan view thereof;  
FIG. 6 is a bottom plan view thereof;  
FIG. 7 is a first perspective view thereof;  
FIG. 8 is a second perspective view thereof; and,  
FIG. 9 is a perspective view thereof showing state change in use.

(56) **References Cited**

**U.S. PATENT DOCUMENTS**

D272,227 S \* 1/1984 Linden ..... D8/57  
D350,466 S \* 9/1994 Ramsey ..... D8/57  
D353,087 S \* 12/1994 Ramsey ..... D8/57  
D363,866 S \* 11/1995 Ramsey ..... D8/57  
D395,584 S \* 6/1998 Gstalder ..... D8/57

In the drawings, the broken lines represent portions of the article which form no part of the claimed design.

**1 Claim, 7 Drawing Sheets**

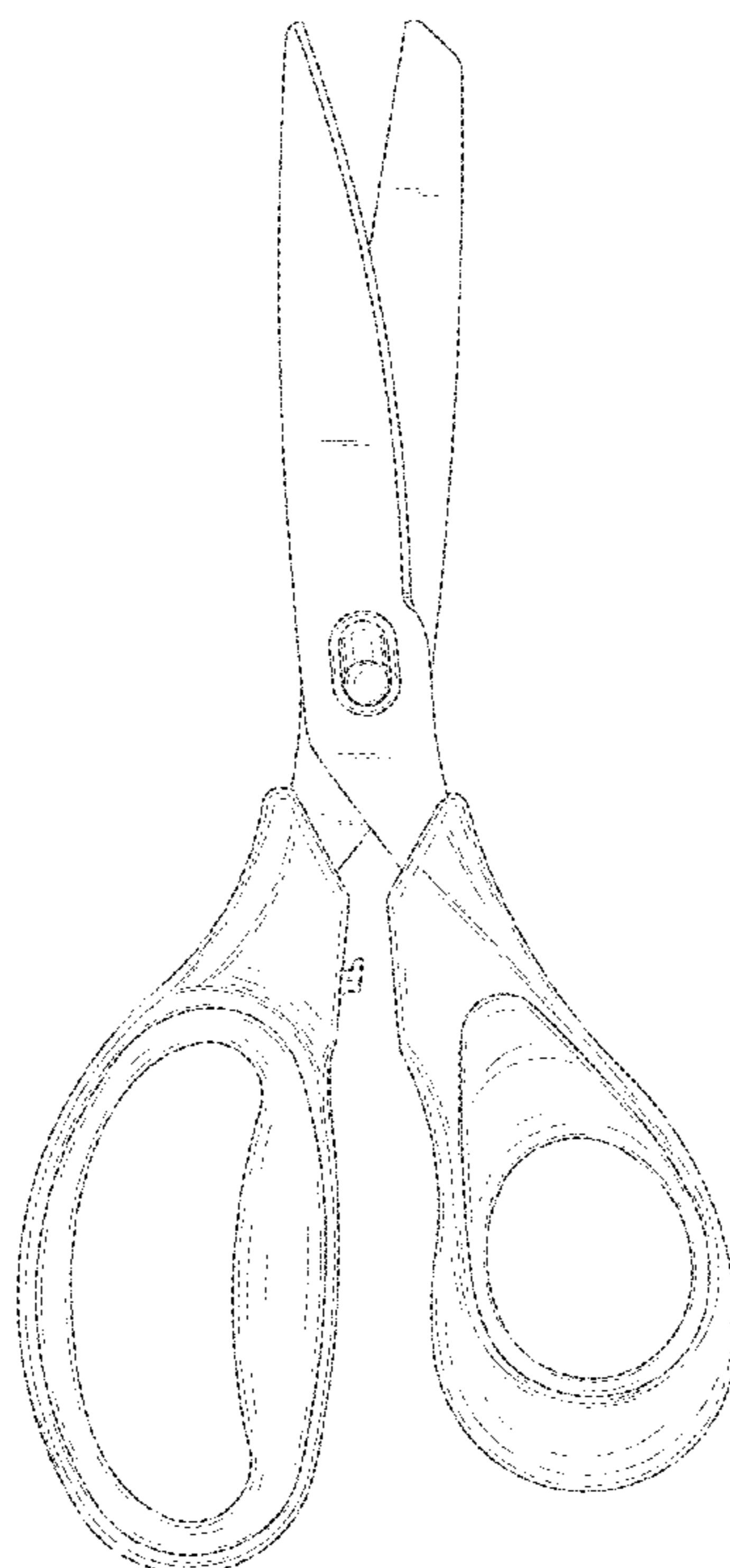

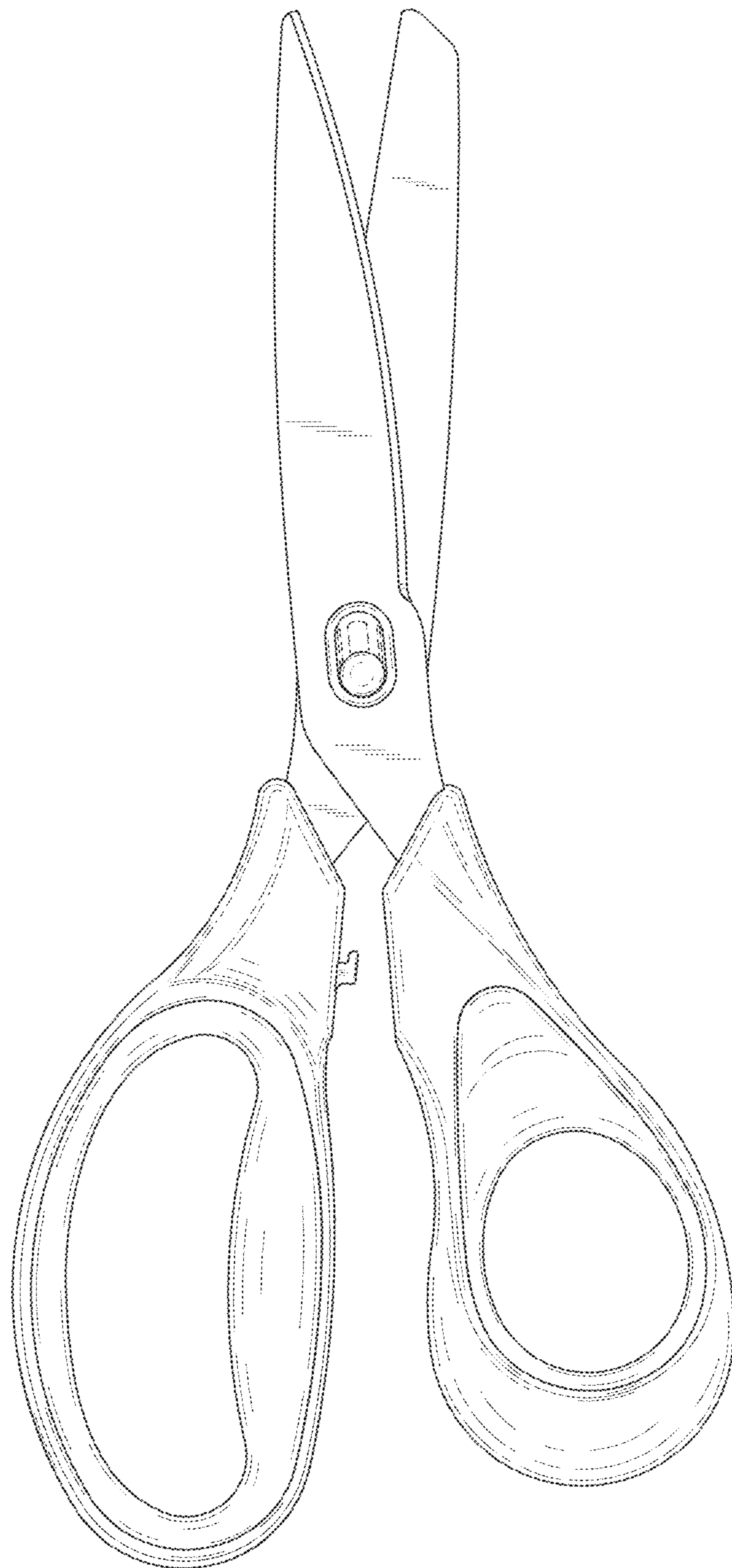

FIG. 1

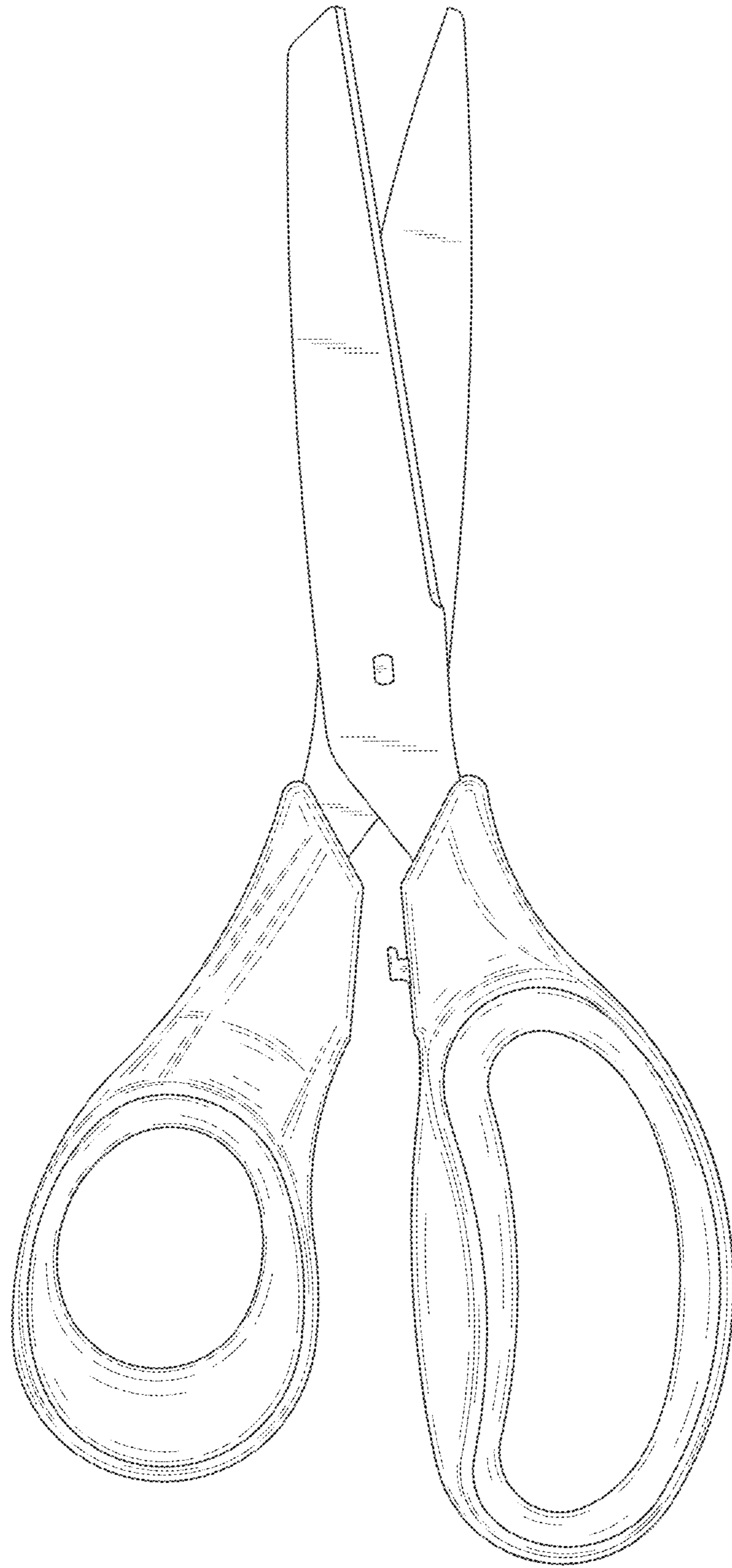

FIG.2

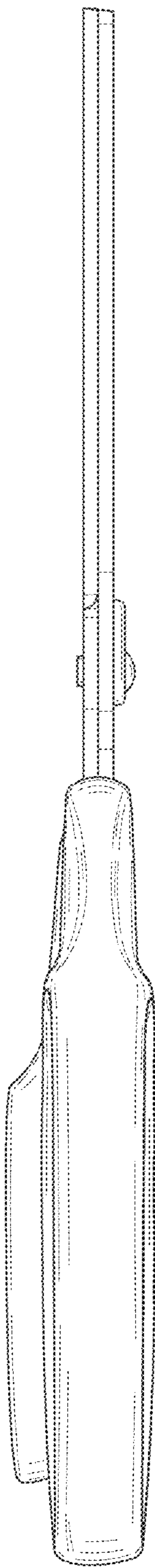

FIG. 3

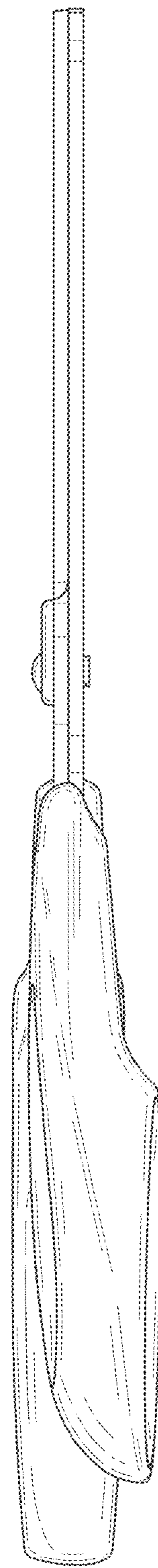

FIG. 4

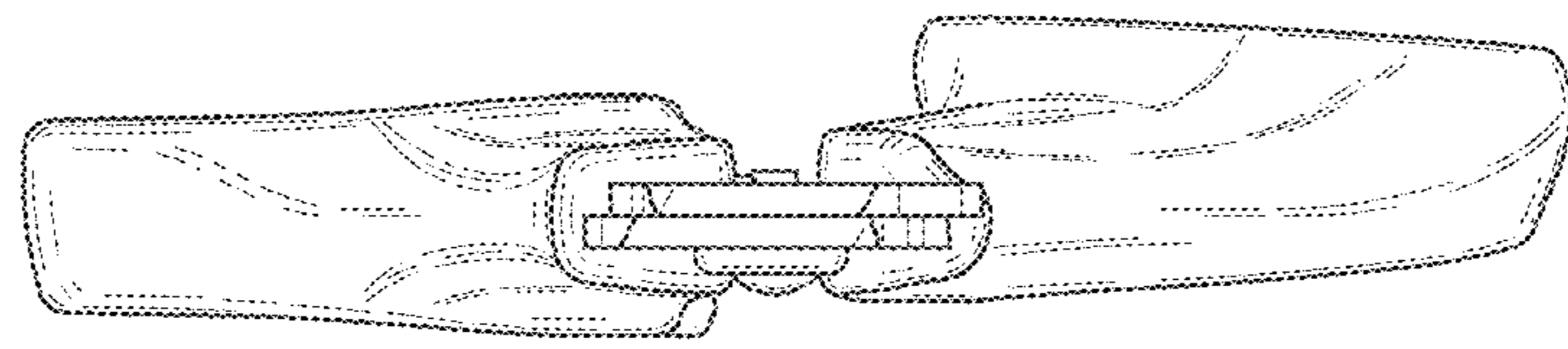

FIG. 5

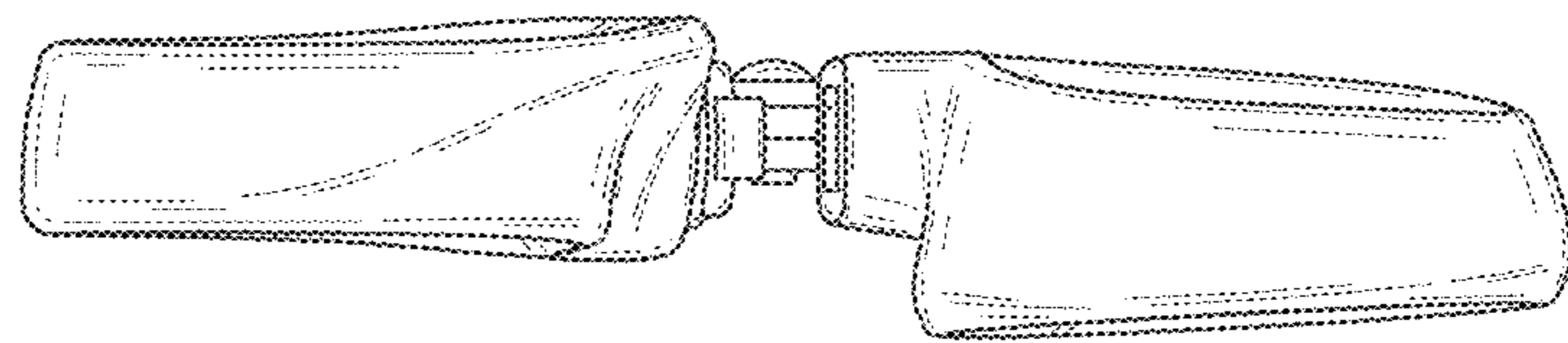

FIG. 6

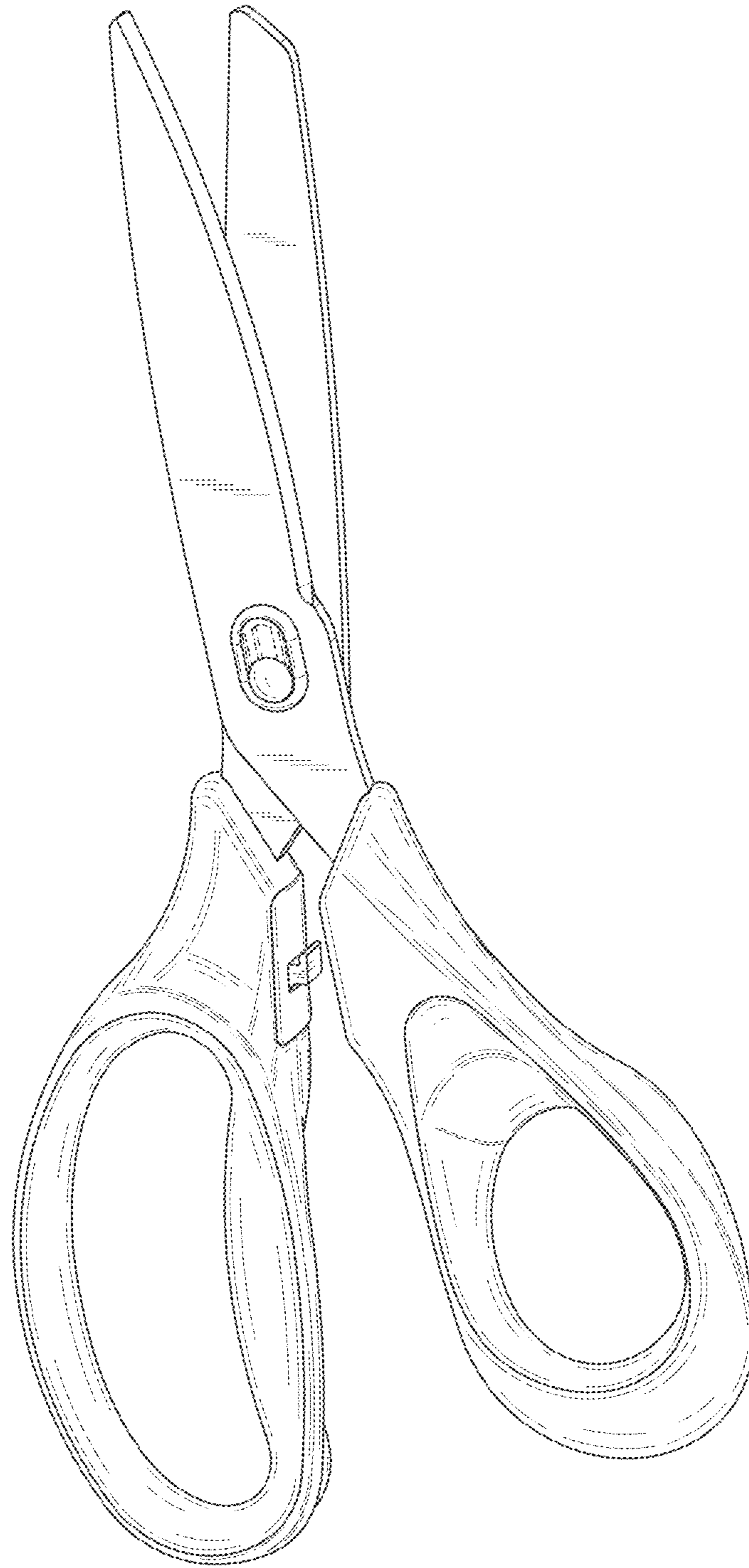

FIG. 7

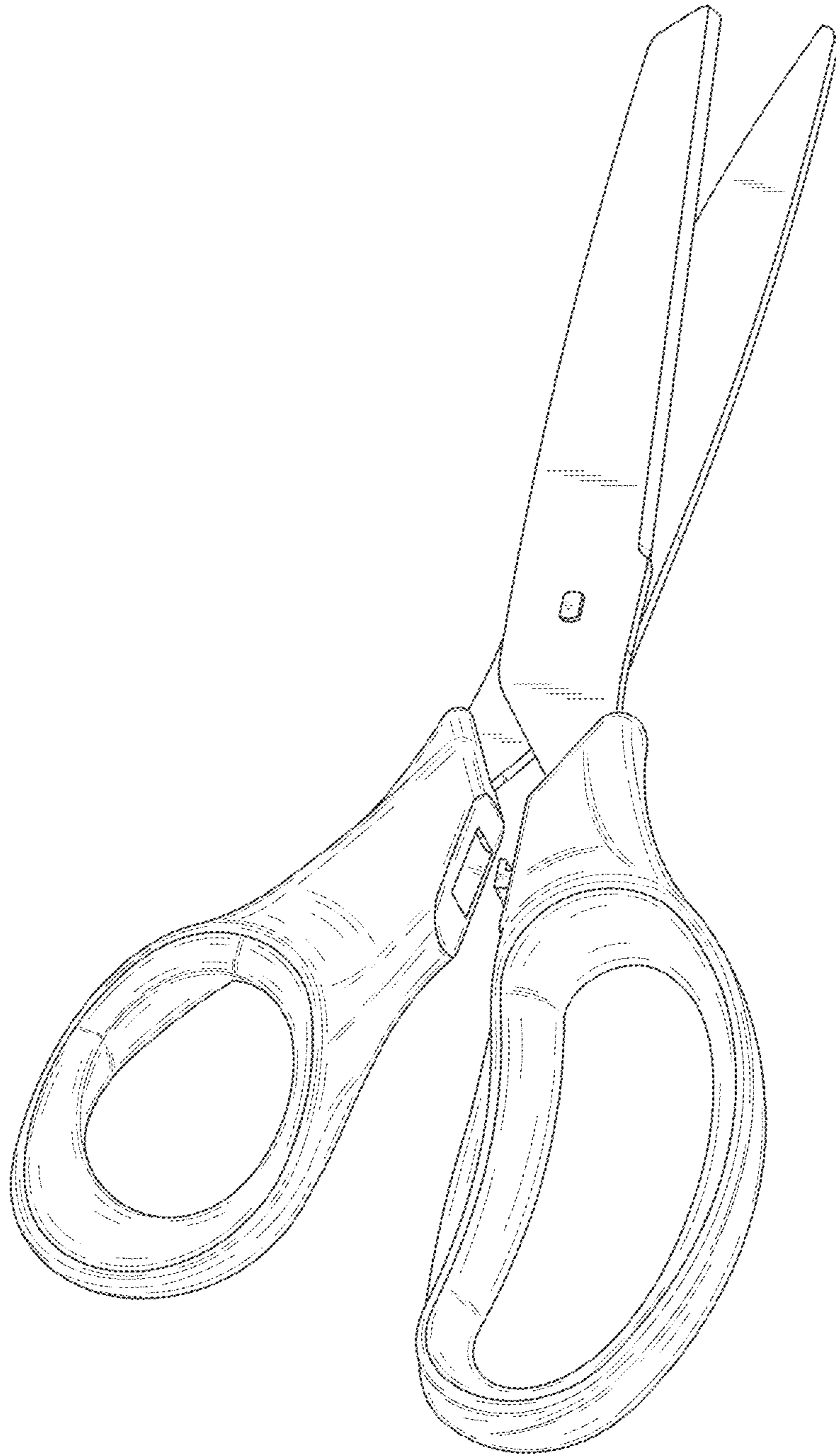

FIG. 8

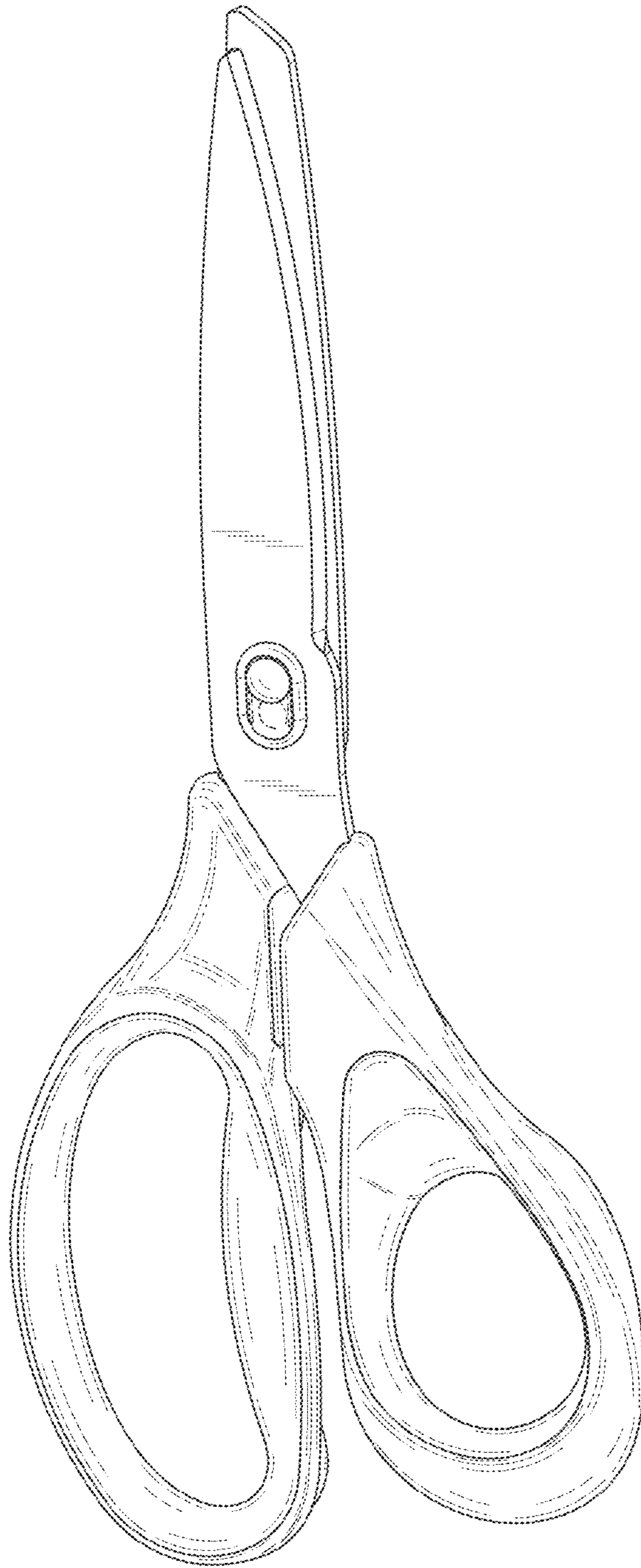

FIG.9