



US00D980013S

(12) **United States Design Patent** (10) **Patent No.:** **US D980,013 S**
Avalos et al. (45) **Date of Patent:** **** Mar. 7, 2023**

(54) **COOKING APPLIANCE**

8,510,913 B2 8/2013 Kim
D690,994 S * 10/2013 Baek D7/405
9,115,903 B2 8/2015 Lim et al.
(Continued)

(71) Applicant: **WHIRLPOOL CORPORATION**,
Benton Harbor, MI (US)

(72) Inventors: **Jose Avalos**, Apodaca (MX); **Wesley Mendez**, Monterrey (MX); **Guilherme Nehring**, Joinville (BR)

FOREIGN PATENT DOCUMENTS

FR 2575512 B3 7/1987
FR 2934671 B1 9/2010
(Continued)

(73) Assignee: **WHIRLPOOL CORPORATION**,
Benton Harbor, MI (US)

Primary Examiner — Andrew Kerr
(74) *Attorney, Agent, or Firm* — Price Heneveld LLP

(**) Term: **15 Years**

(21) Appl. No.: **29/705,441**

(57) **CLAIM**

The ornamental design for a cooking appliance, as shown and described.

(22) Filed: **Sep. 12, 2019**

Related U.S. Application Data

DESCRIPTION

(63) Continuation-in-part of application No. 16/456,544, filed on Jun. 28, 2019, now Pat. No. 11,326,784, and a continuation-in-part of application No. 16/456,496, filed on Jun. 28, 2019, now Pat. No. 11,060,333.

FIG. 1 is a perspective view of a cooking appliance according to the design in a first position;
FIG. 2 is a front elevation view thereof;
FIG. 3 is a back elevation view thereof;
FIG. 4 is a right side elevation view thereof;
FIG. 5 is a left side elevation view thereof;
FIG. 6 is a top plan view thereof;
FIG. 7 is a bottom plan view thereof;
FIG. 8 is a perspective view of thereof in a second position;
FIG. 9 is a front elevation view thereof;
FIG. 10 is a back elevation view thereof;
FIG. 11 is a right side elevation view thereof;
FIG. 12 is a left side elevation view thereof;
FIG. 13 is a top plan view thereof; and,
FIG. 14 is a bottom plan view thereof.

(51) **LOC (14) Cl.** **07-02**

(52) **U.S. Cl.**
USPC **D7/405**

(58) **Field of Classification Search**
USPC D7/387, 402, 405, 406, 339, 340, 346,
D7/347, 348, 349, 350.1, 350.2, 350.3,
D7/350.4, 351
CPC .. H05B 1/0261; H05B 1/0263; H05B 1/0266;
F24C 3/00; F24C 3/008; F24C 15/02;
F24C 15/028
See application file for complete search history.

The dash-dash broken lines in the drawings depict portions of the cooking appliance that form no part of the claimed design.

The dash-dot-dash lines adjacent un-shaded areas represent bounds of the claimed design and form no part thereof.

(56) **References Cited**

U.S. PATENT DOCUMENTS

6,561,180 B1 5/2003 Austin et al.
7,111,363 B2 9/2006 Lee et al.
D569,686 S * 5/2008 Martin D7/405

1 Claim, 14 Drawing Sheets

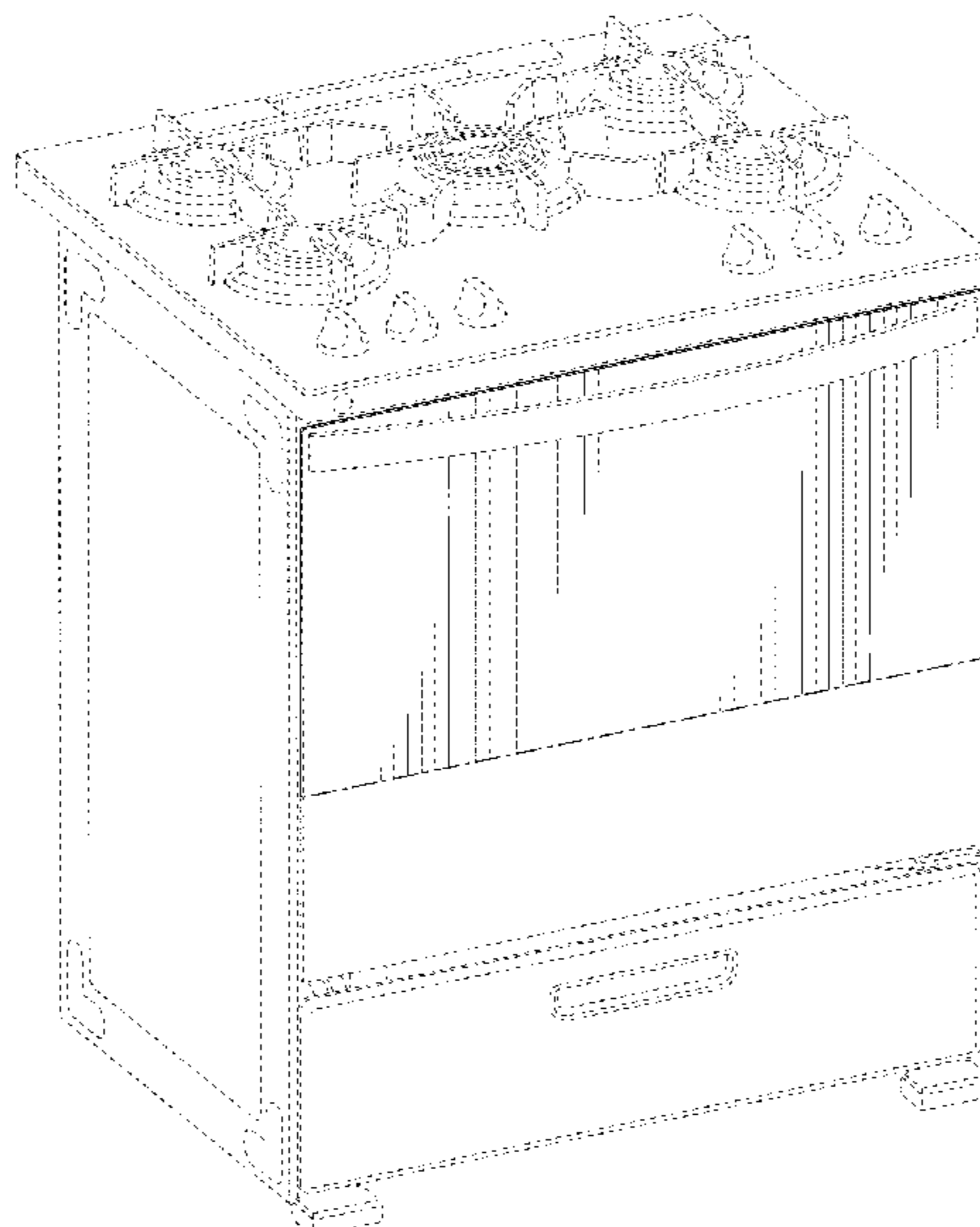

(56)

References Cited

U.S. PATENT DOCUMENTS

D766,030 S * 9/2016 Chung D7/348
D862,165 S * 10/2019 Jung D7/405
D869,233 S * 12/2019 Jo D7/405
D909,812 S * 2/2021 Kim D7/405
D914,443 S * 3/2021 Spurrier D7/405
10,941,946 B2 * 3/2021 Jung F24C 15/16
11,015,815 B2 * 5/2021 Yun F24C 15/028
D934,629 S * 11/2021 Lees D7/405
D945,824 S * 3/2022 Kim D7/405

FOREIGN PATENT DOCUMENTS

GB 2410059 B 7/2005
KR 20000034540 A 6/2000

* cited by examiner

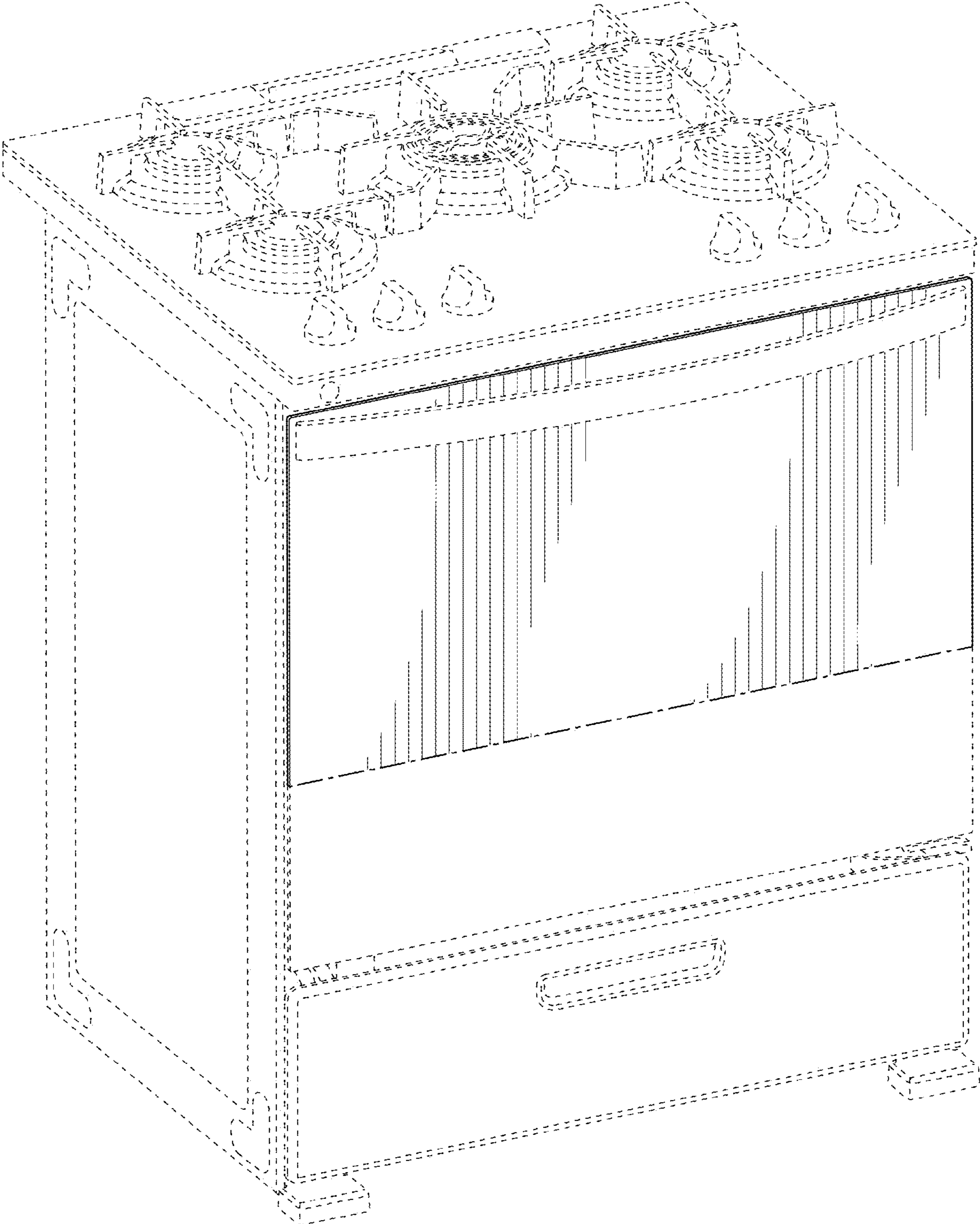

FIG. 1

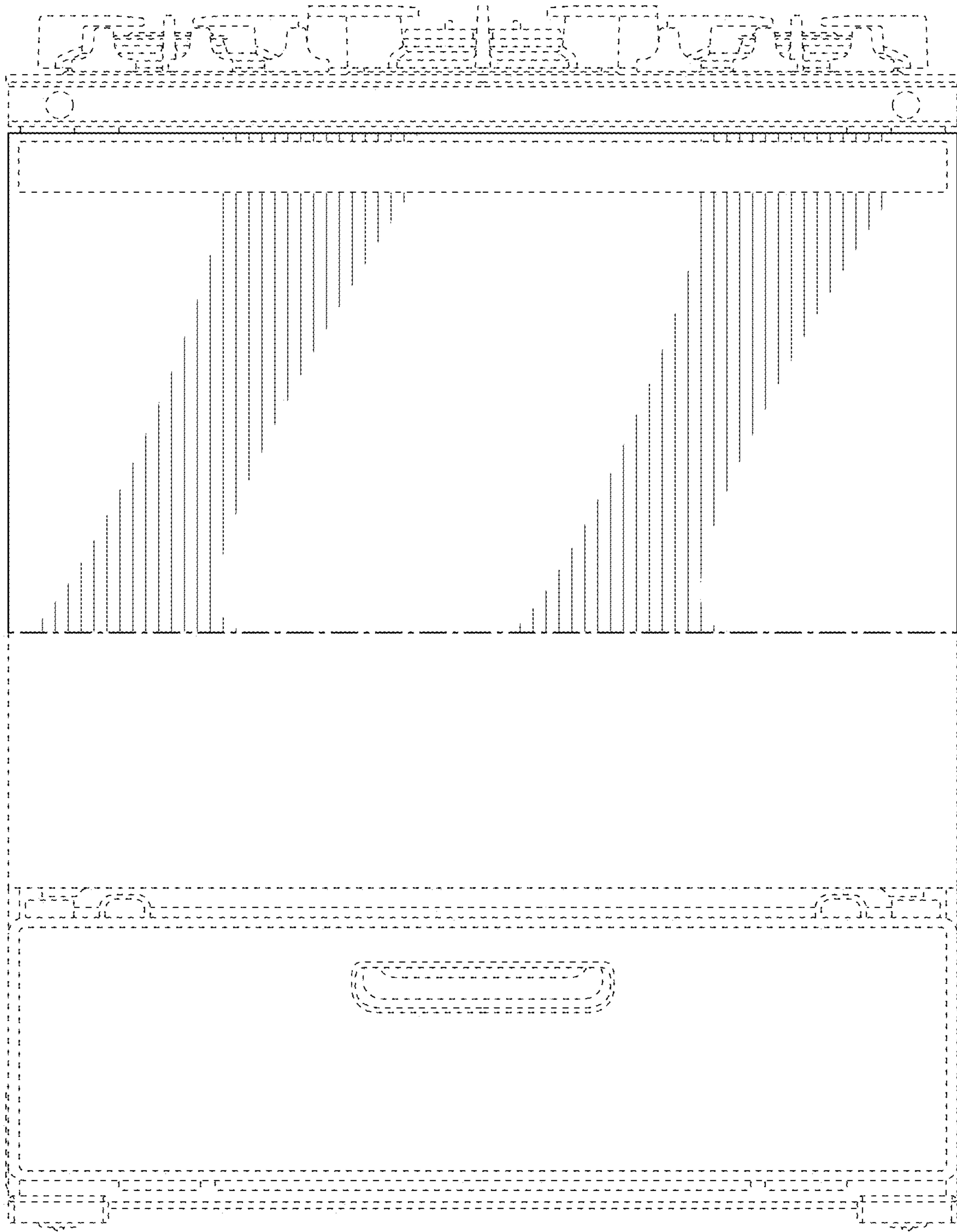

FIG. 2

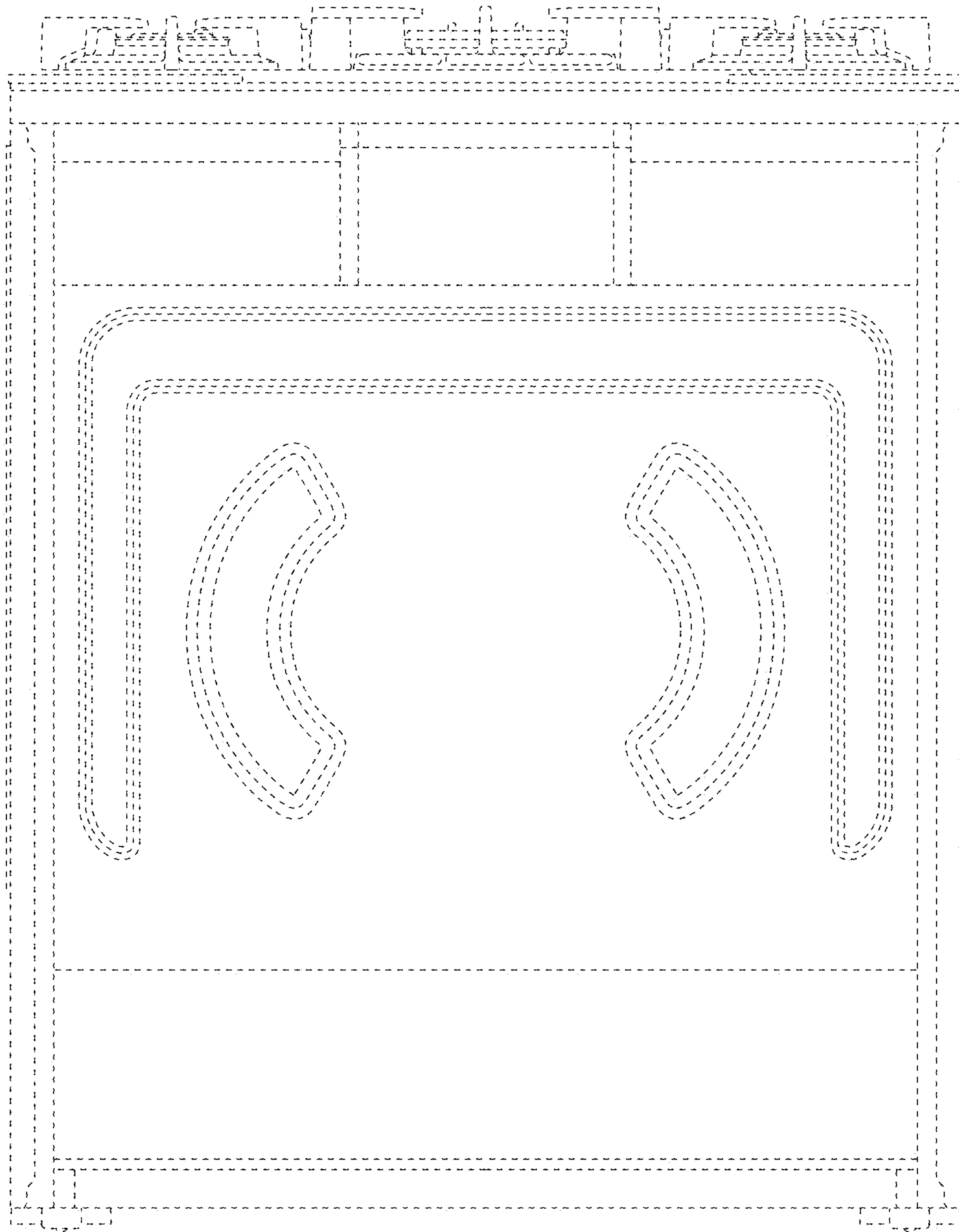

FIG. 3

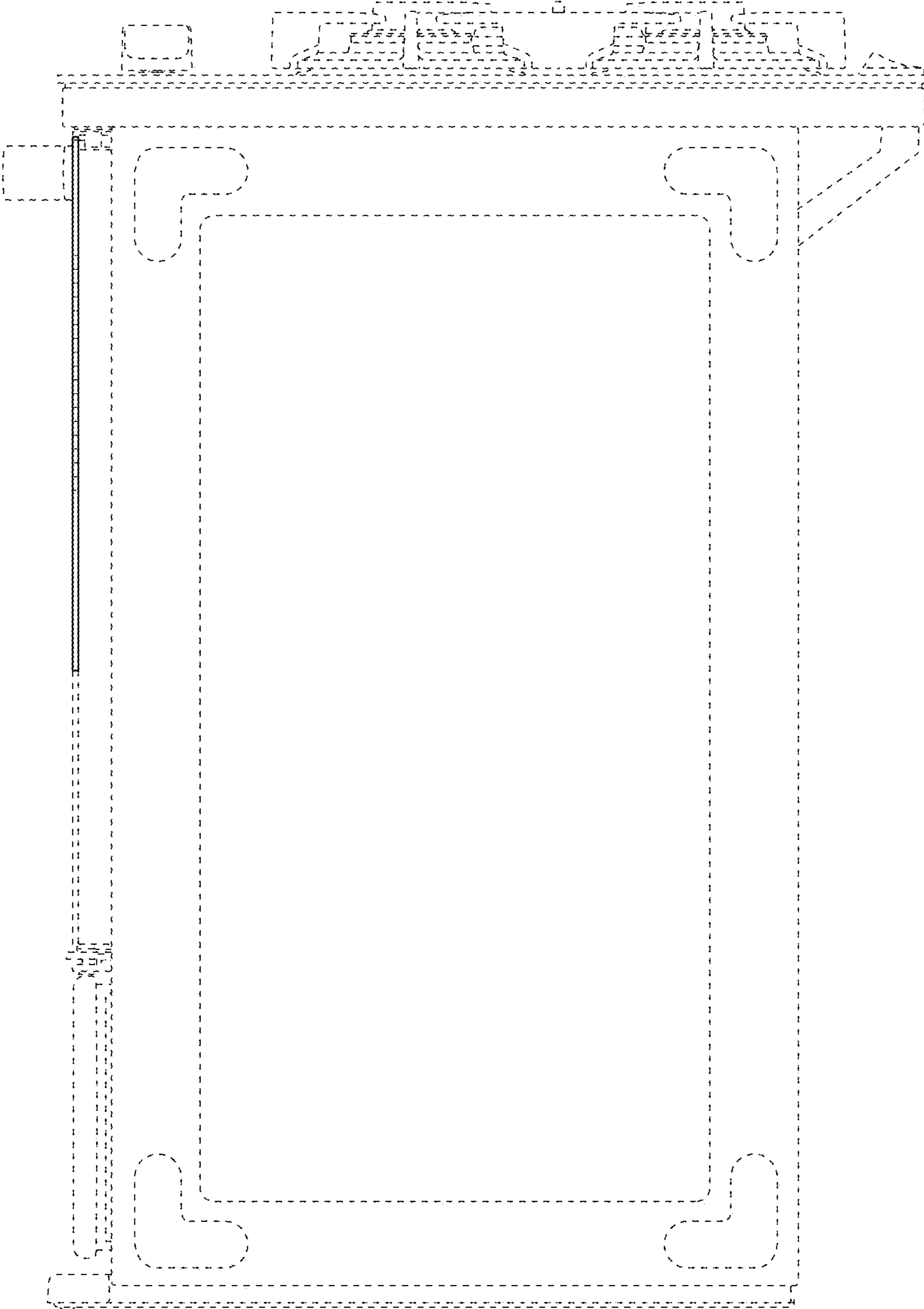

FIG. 4

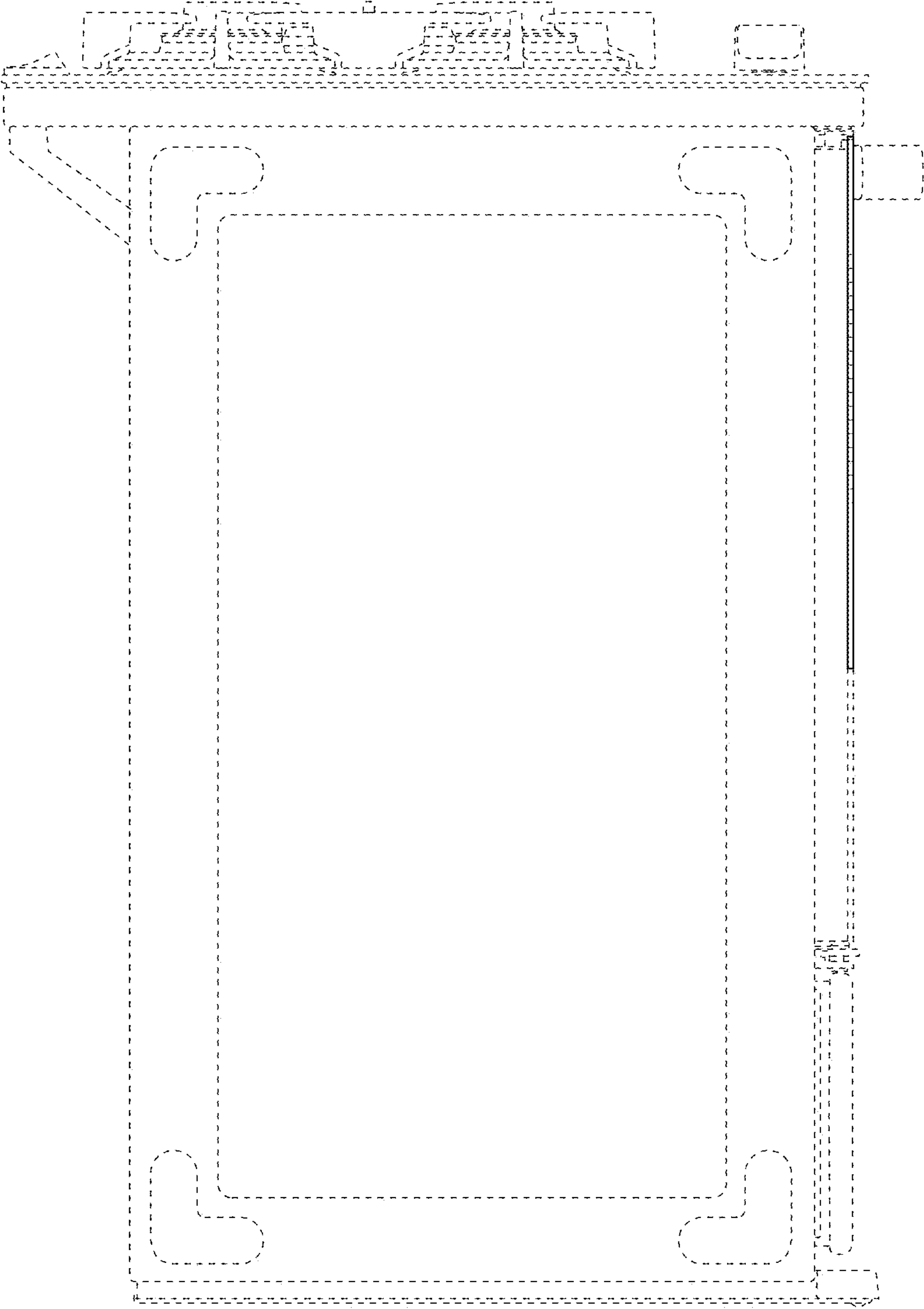

FIG. 5

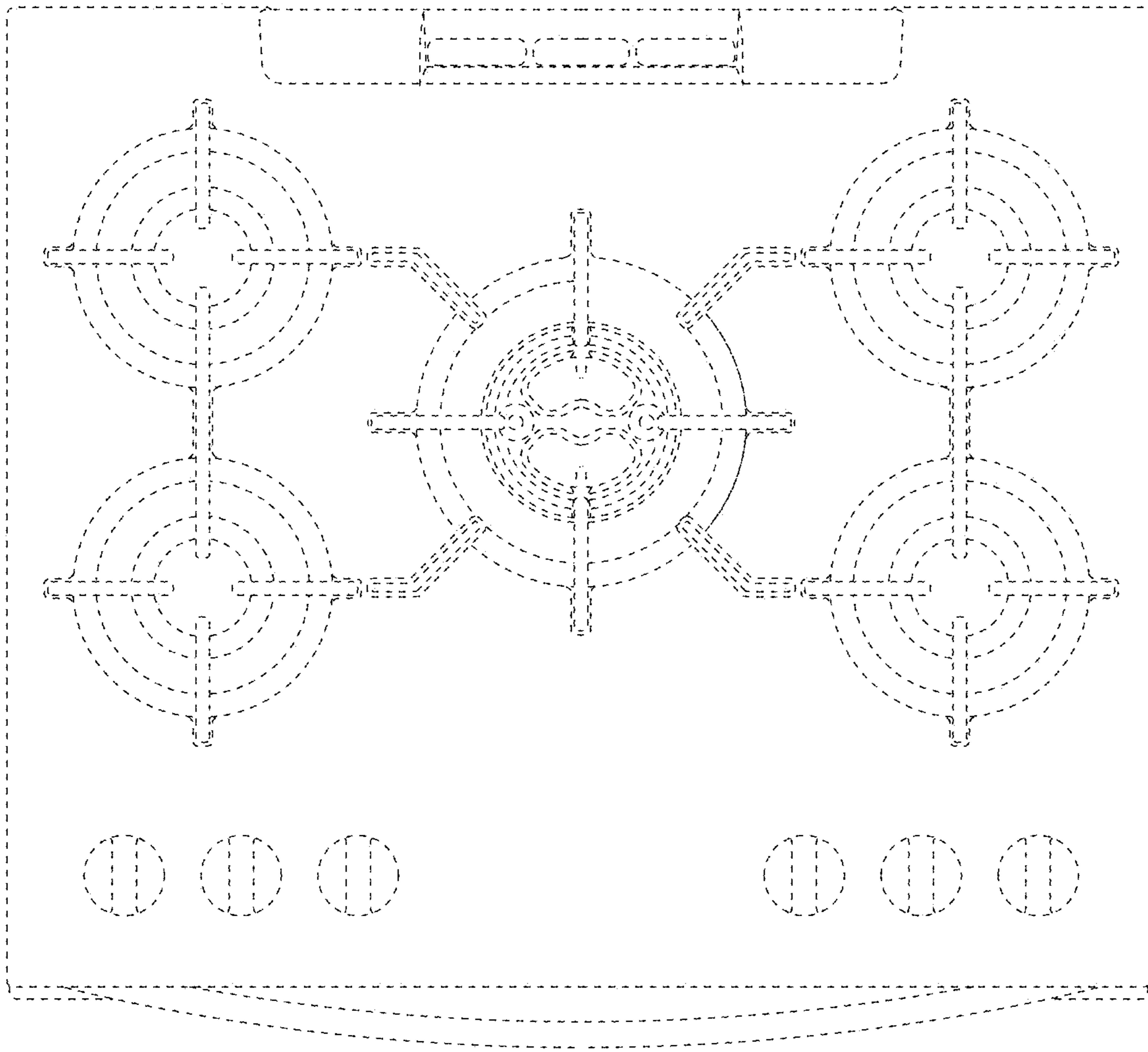

FIG. 6

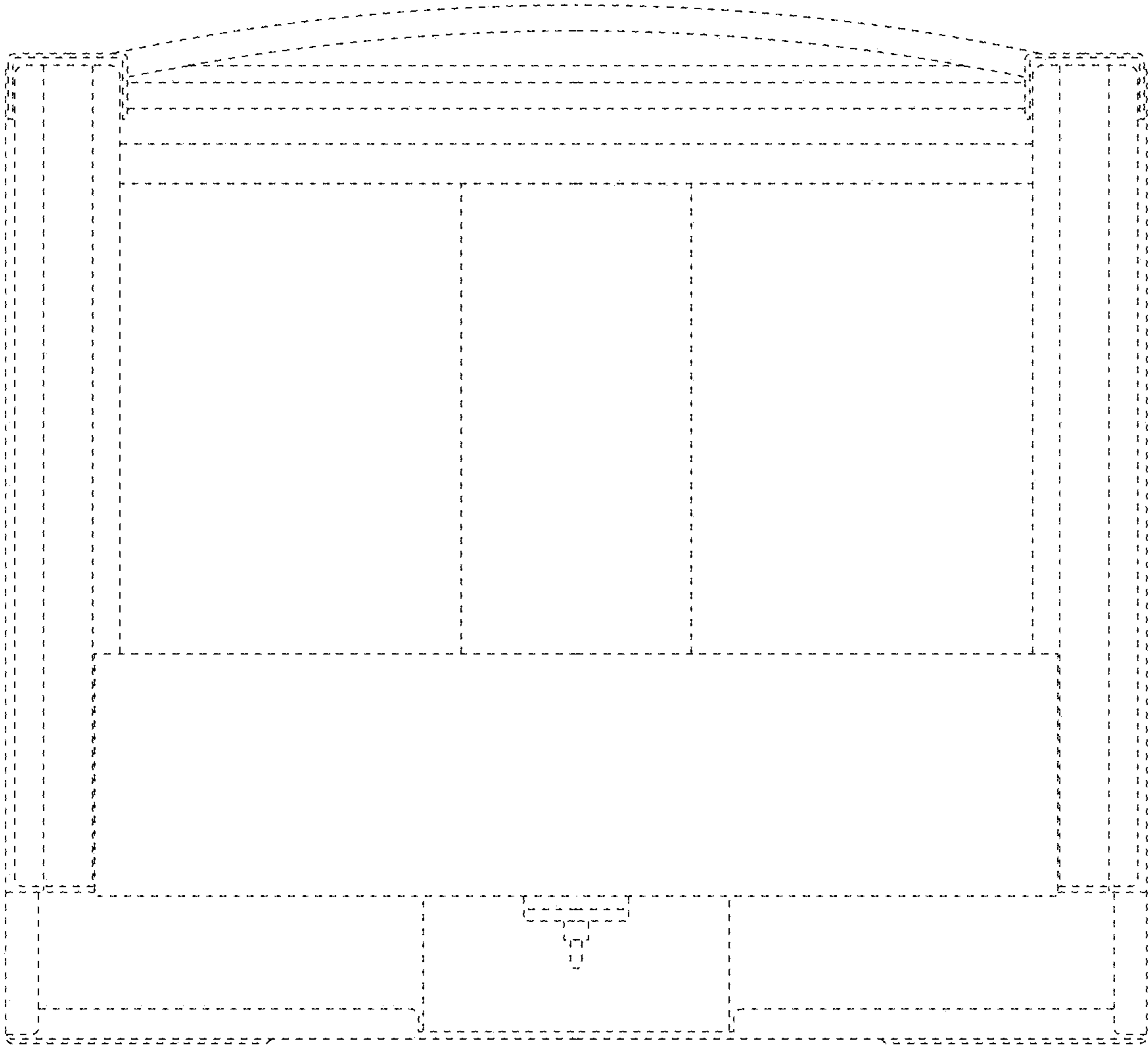

FIG. 7

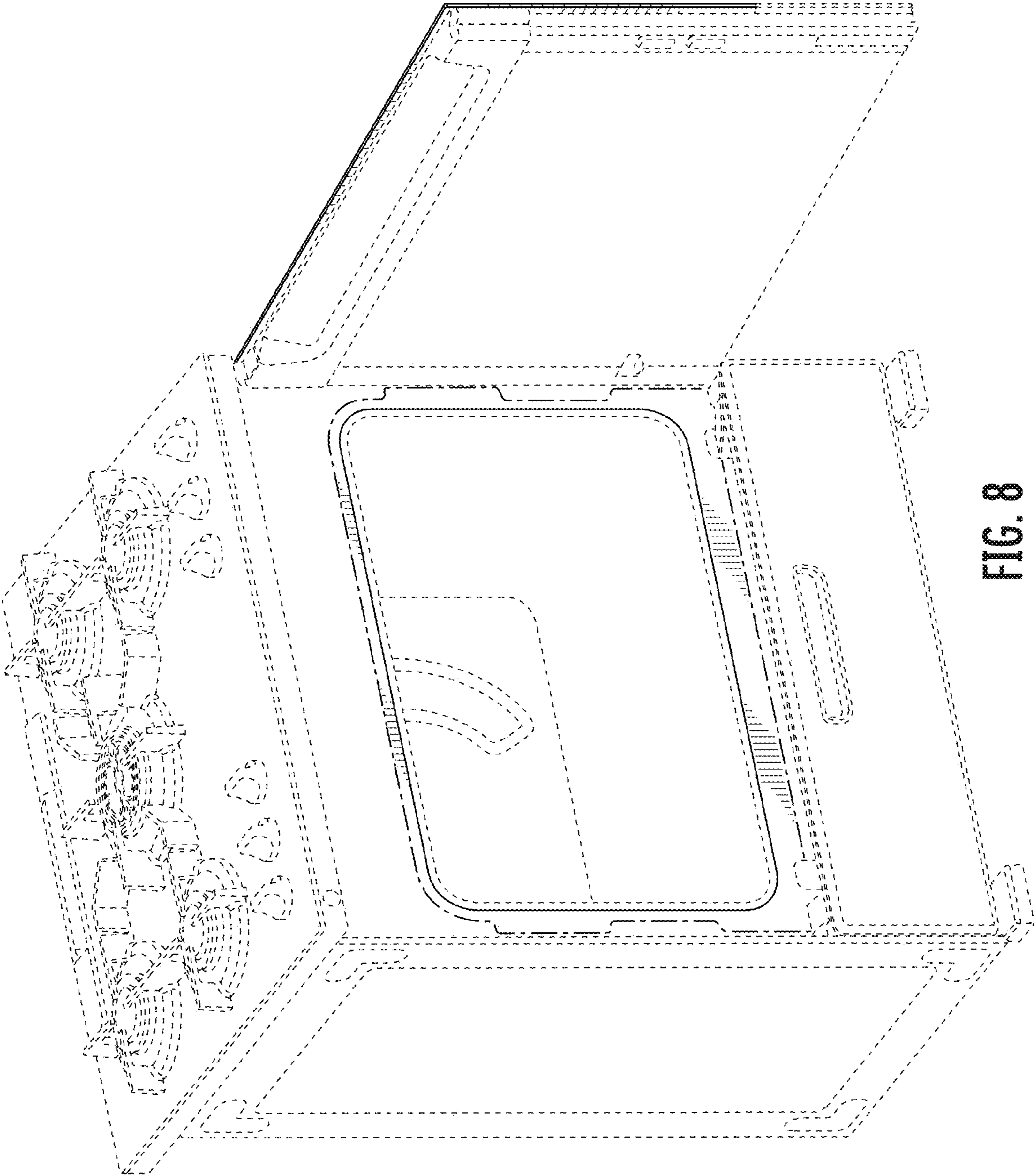

FIG. 8

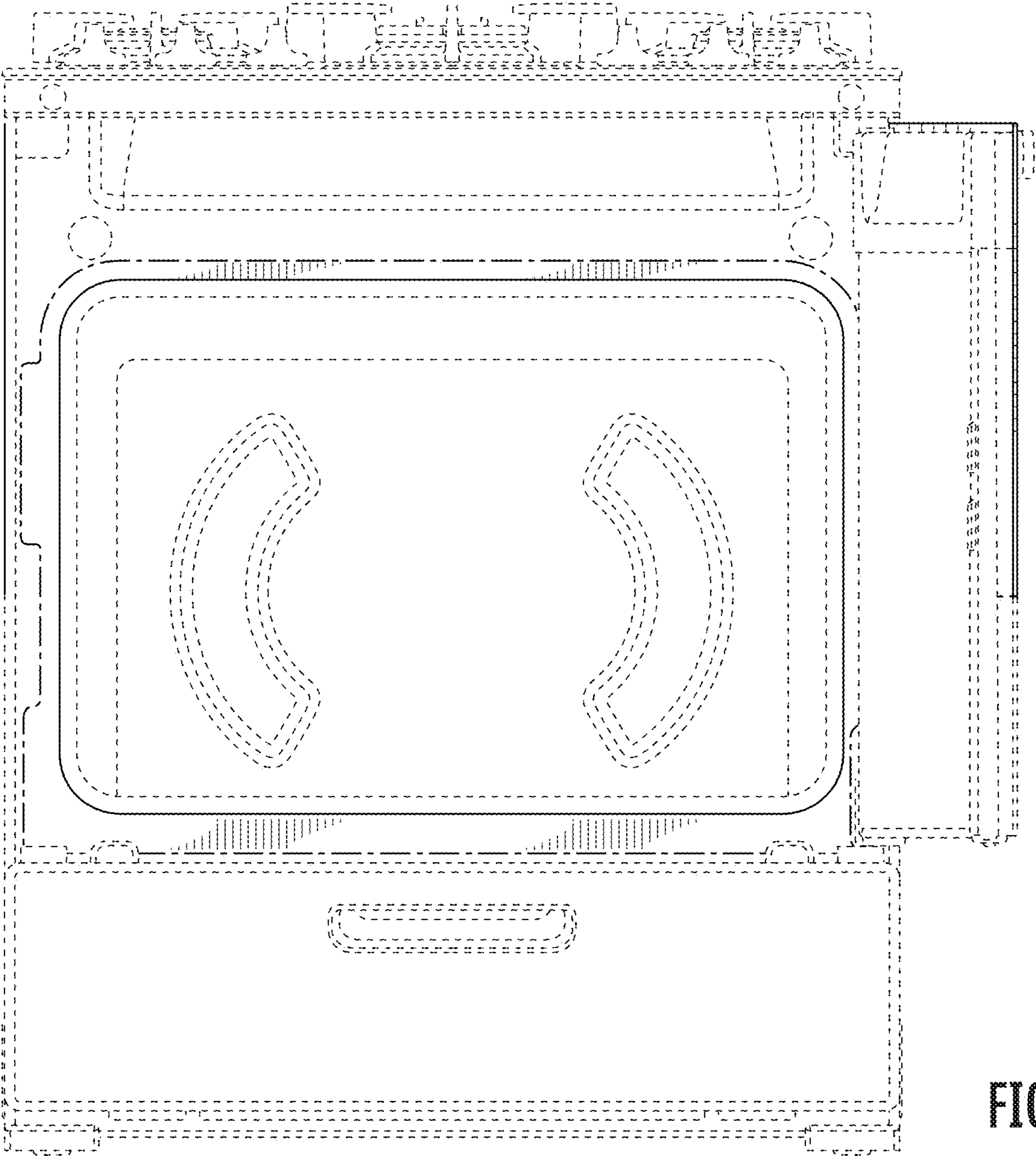

FIG. 9

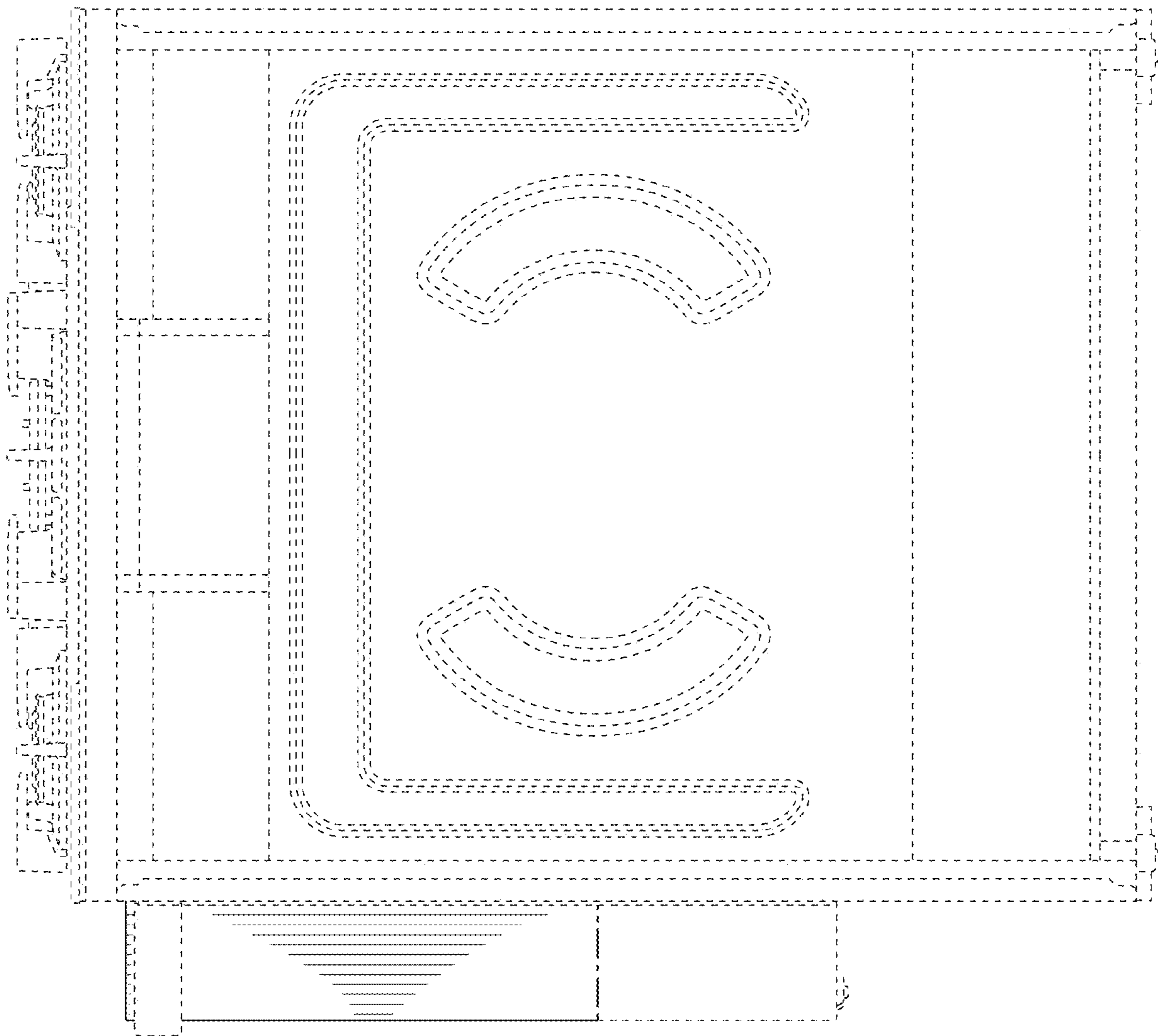

FIG. 10

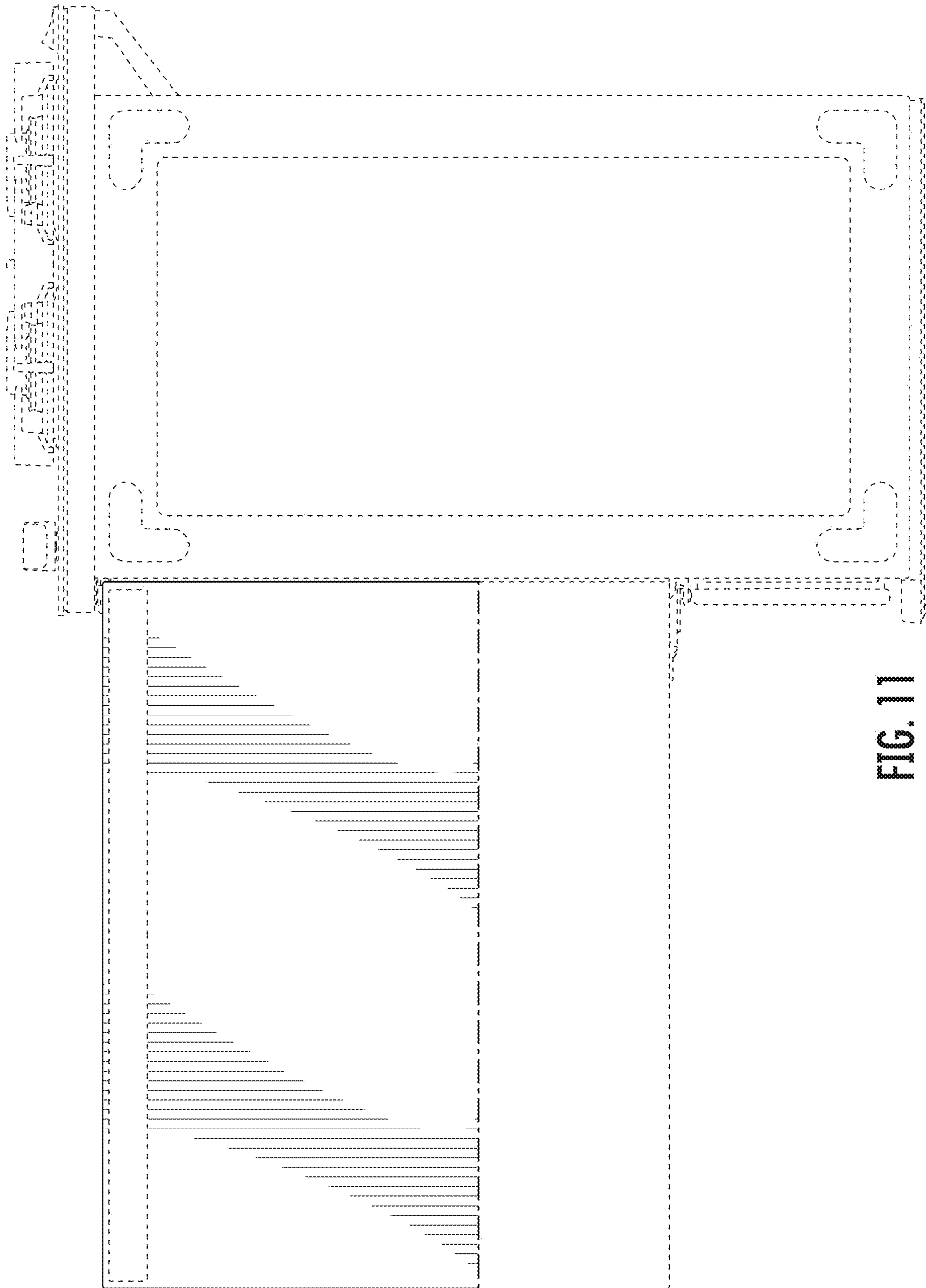

FIG. 11

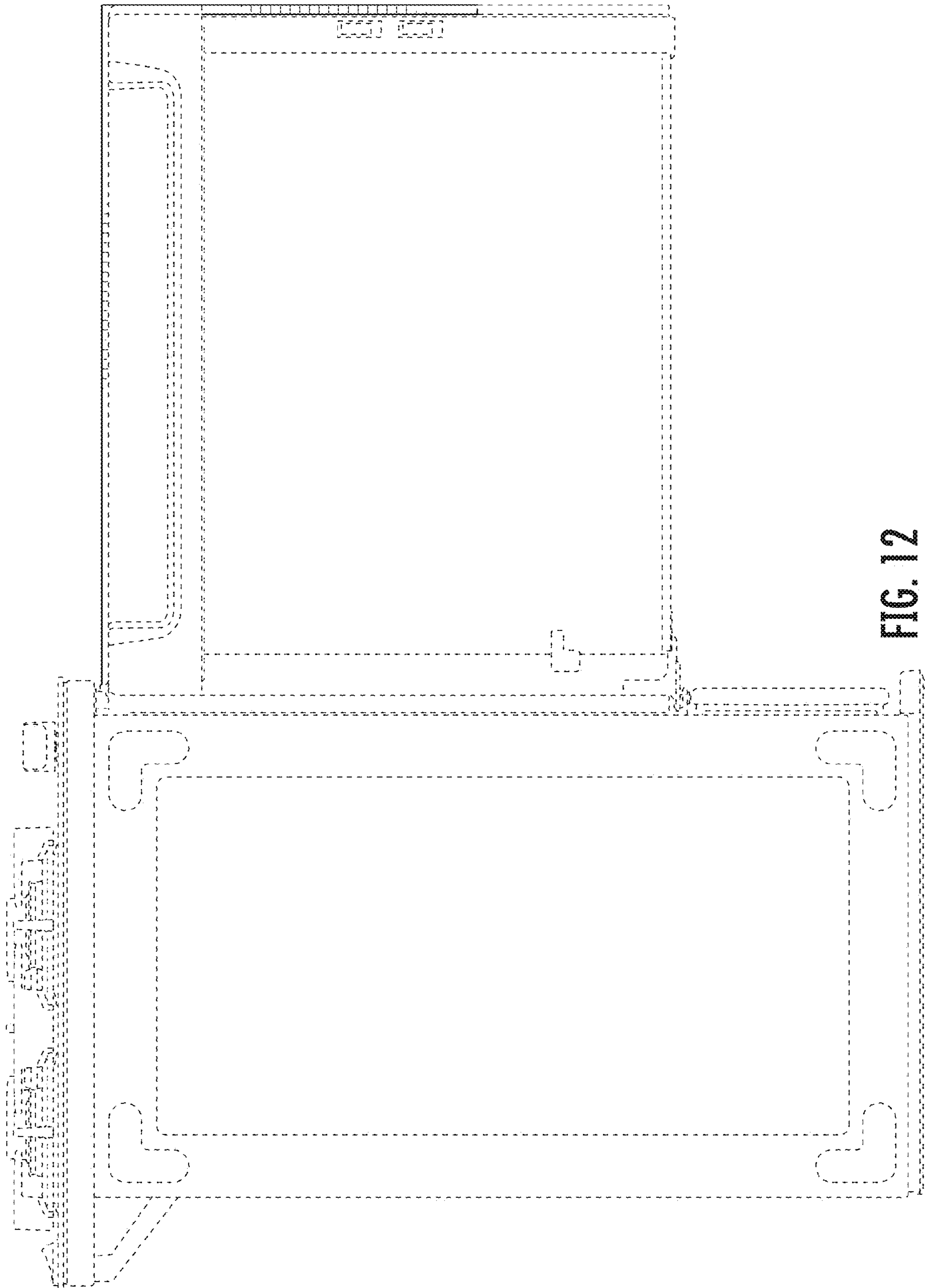

FIG. 12

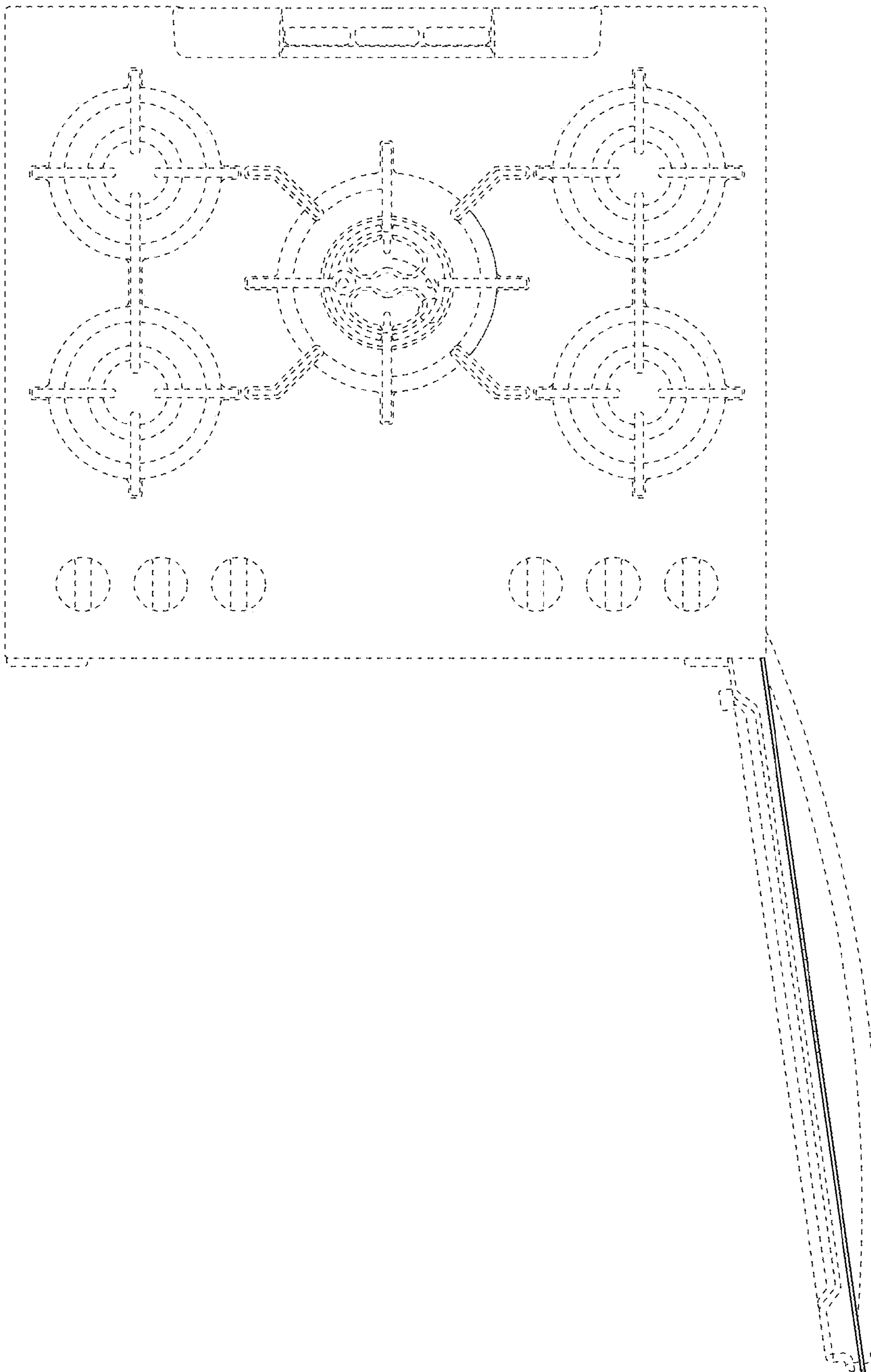

FIG. 13

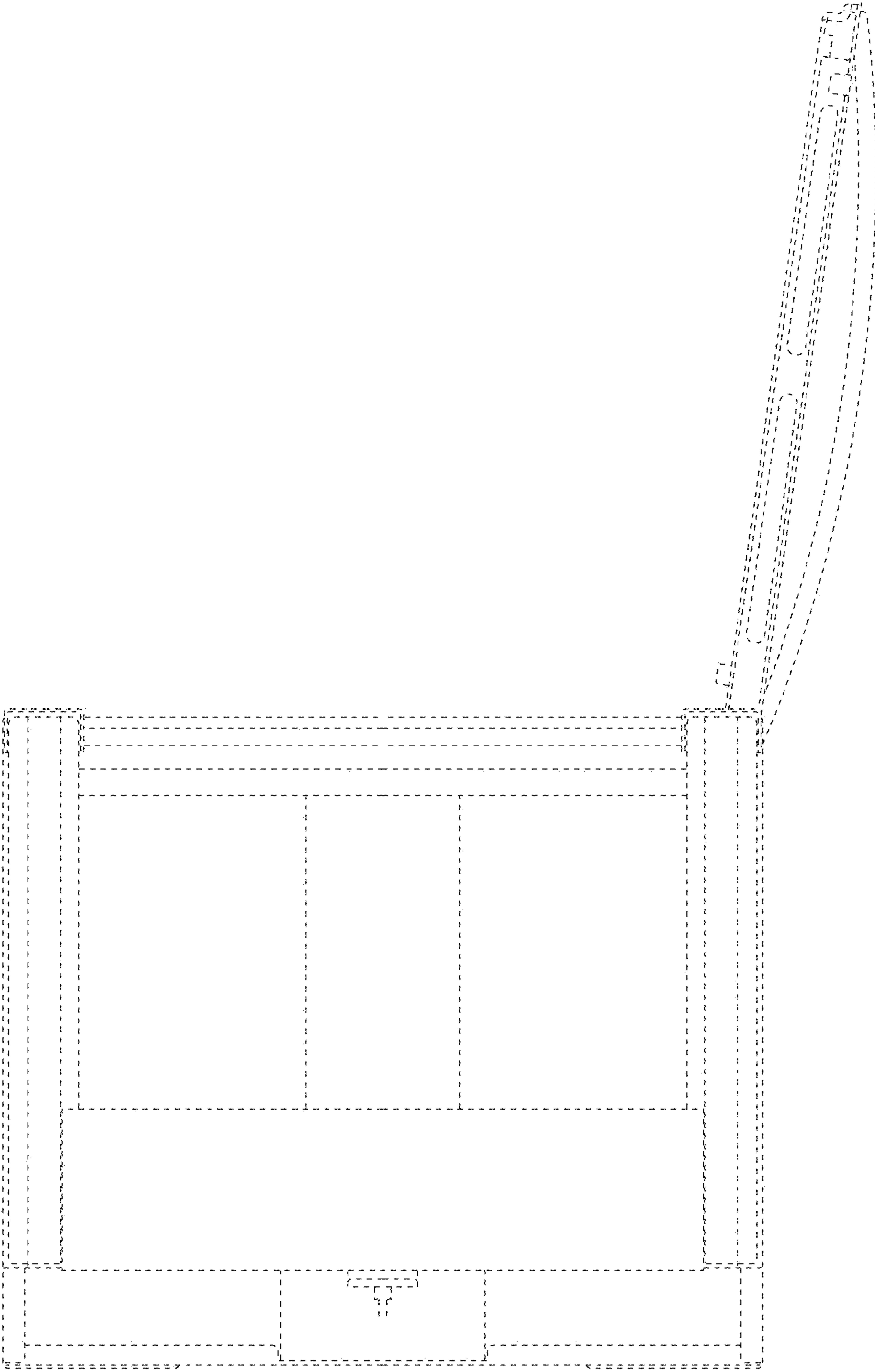

FIG. 14