



US00D979819S

(12) **United States Design Patent**
Wu

(10) **Patent No.:** **US D979,819 S**

(45) **Date of Patent:** **** Feb. 28, 2023**

(54) **VEHICLE LIGHT PART**

(71) Applicant: **COPLUS INC.**, Tainan (TW)

(72) Inventor: **Po-Hua Wu**, Tainan (TW)

(73) Assignee: **COPLUS INC.**, Tainan (TW)

(**) Term: **15 Years**

(21) Appl. No.: **29/786,813**

(22) Filed: **Jun. 2, 2021**

(30) **Foreign Application Priority Data**

Mar. 11, 2021 (TW) 110301247

(51) **LOC (14) Cl.** **26-06**

(52) **U.S. Cl.**
USPC **D26/36**

(58) **Field of Classification Search**
USPC D26/28, 29, 30, 31, 32, 33, 34, 35, 36,
D26/139

CPC F21W 2103/35; F21W 2103/40; F21W
2102/17; F21W 2102/30; F21W 2103/00;
F21W 2103/55; F21W 2104/00; F21W
2107/17; F21W 2107/13; F21S 41/00;
F21S 41/141; F21S 41/162; F21S 41/18;
F21S 41/20; F21S 41/33; F21S 41/36;
F21S 41/60; F21S 43/00

See application file for complete search history.

(56) **References Cited**

U.S. PATENT DOCUMENTS

D681,242 S * 4/2013 Tsai D26/28
D683,487 S * 5/2013 Scheinhutte D26/28
D745,198 S * 12/2015 Stopka D26/28
D750,819 S * 3/2016 Schneider D26/28
D752,782 S * 3/2016 Moessner D26/28

D837,421 S * 1/2019 Yamashita D26/28
D841,198 S * 2/2019 Yamashita D26/28
D849,287 S * 5/2019 Redlich D26/28
D849,288 S * 5/2019 Redlich D26/28
D934,463 S * 10/2021 Redlich D26/28

* cited by examiner

Primary Examiner — Angela J Lee

(74) *Attorney, Agent, or Firm* — Lewis Roca Rothgerber
Christie LLP

(57) **CLAIM**

The ornamental design for vehicle light part, as shown and
described.

DESCRIPTION

FIG. 1 is a perspective view of the vehicle light part;
FIG. 2 is a front view thereof;
FIG. 3 is a rear view thereof;
FIG. 4 is a left side view thereof;
FIG. 5 is a right side view thereof;
FIG. 6 is a top view thereof; and,
FIG. 7 is a bottom view thereof.

The broken lines in the drawings depict portions of the
article that form no part of the claimed design.

1 Claim, 7 Drawing Sheets

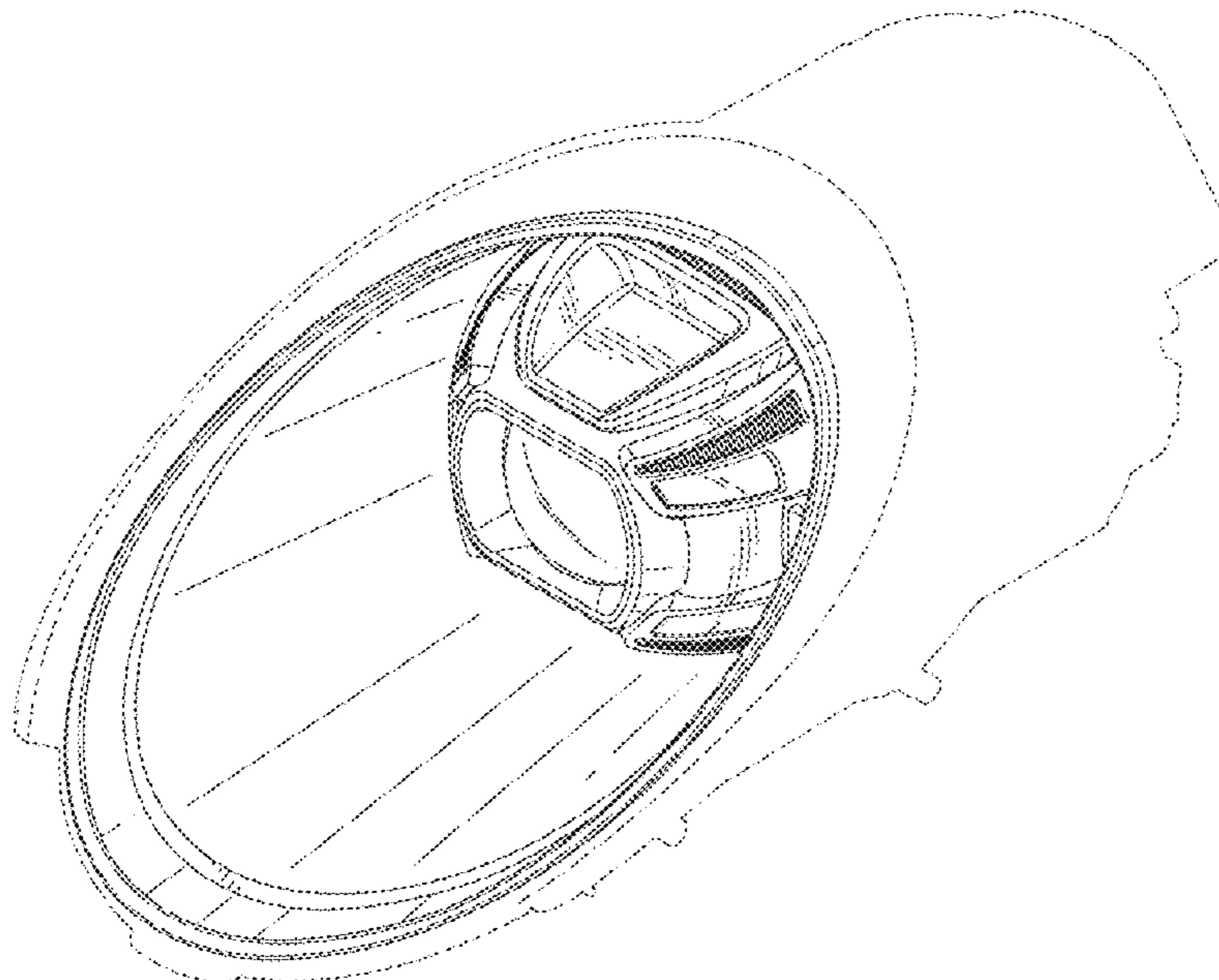

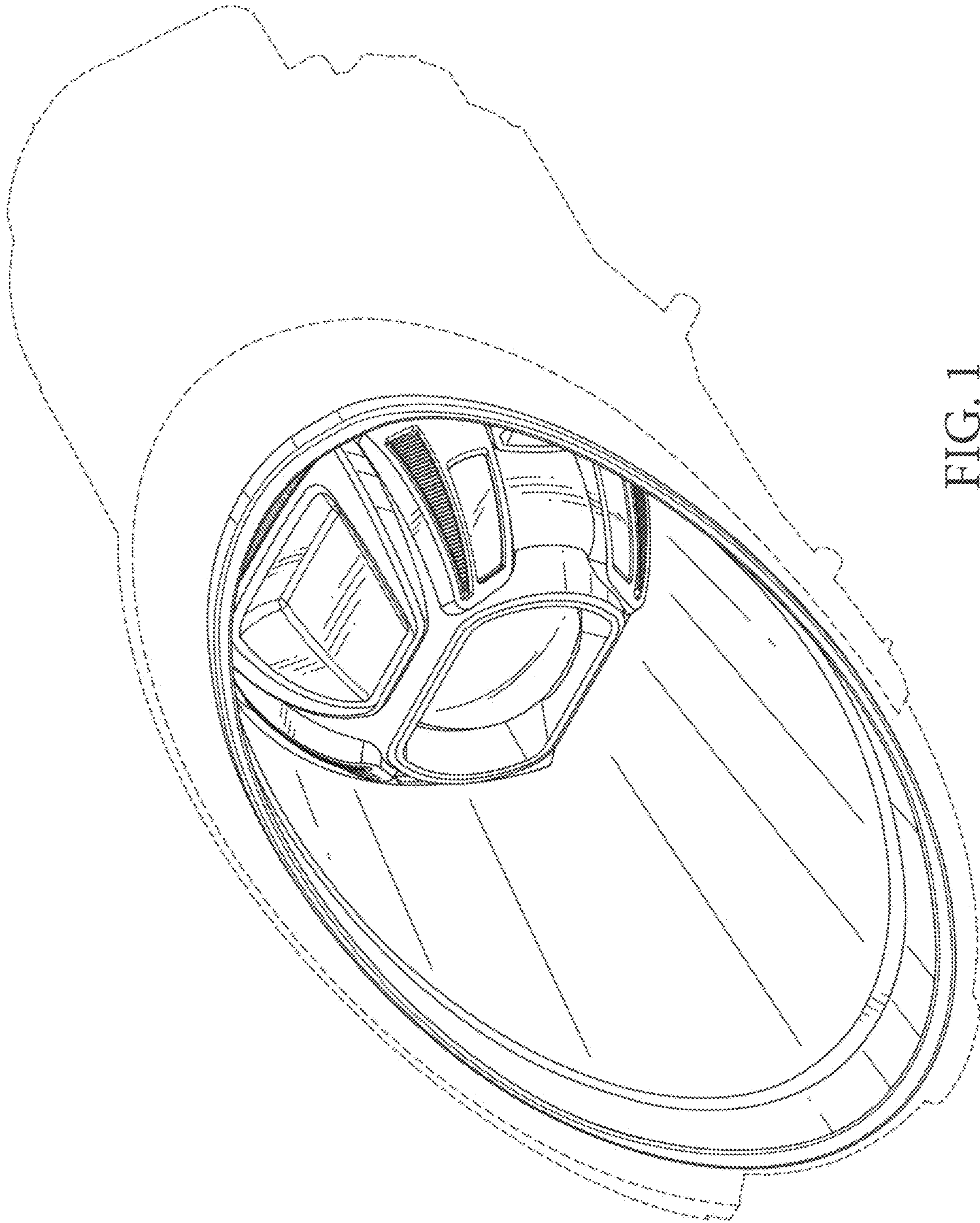

FIG. 1

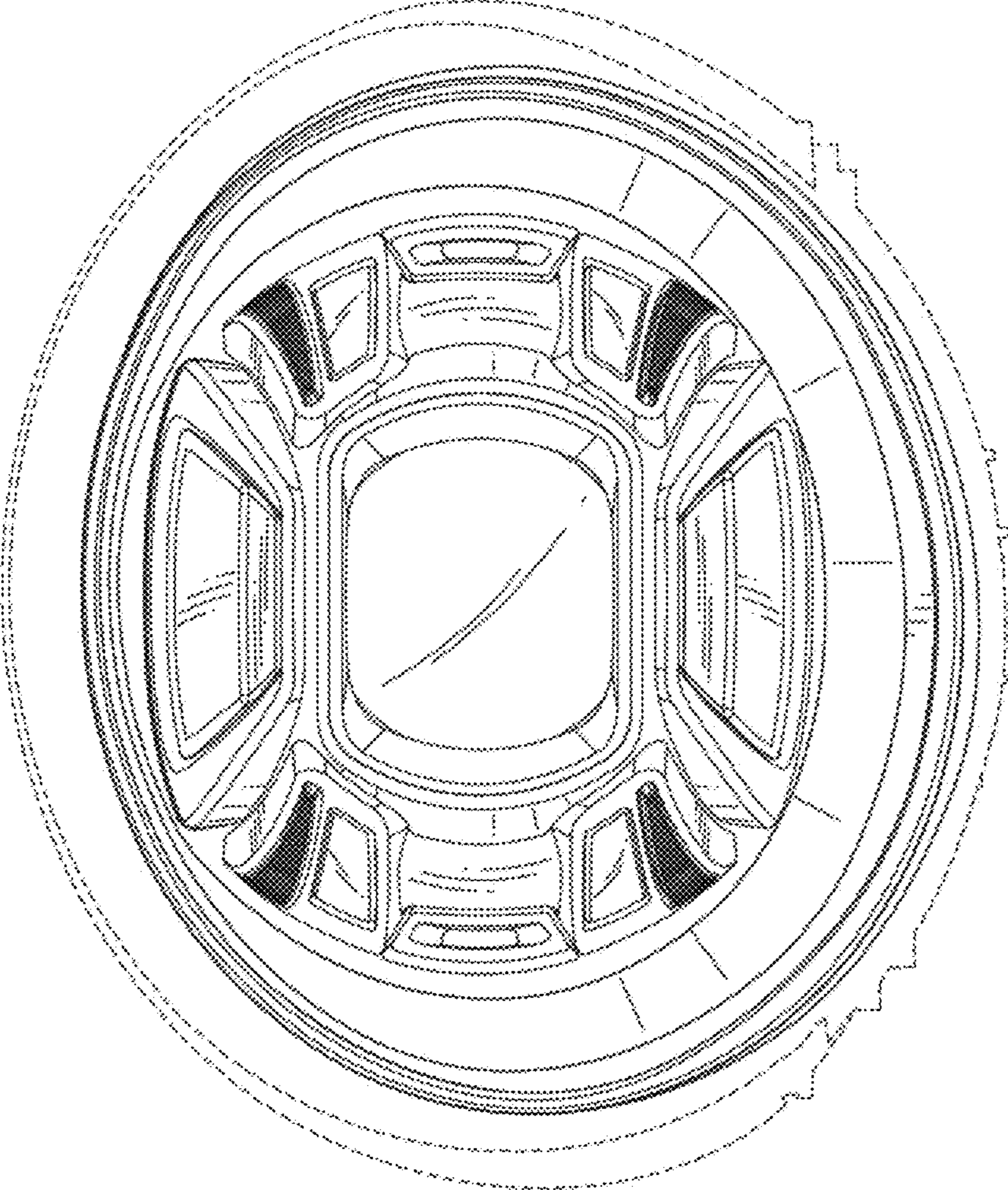

FIG. 2

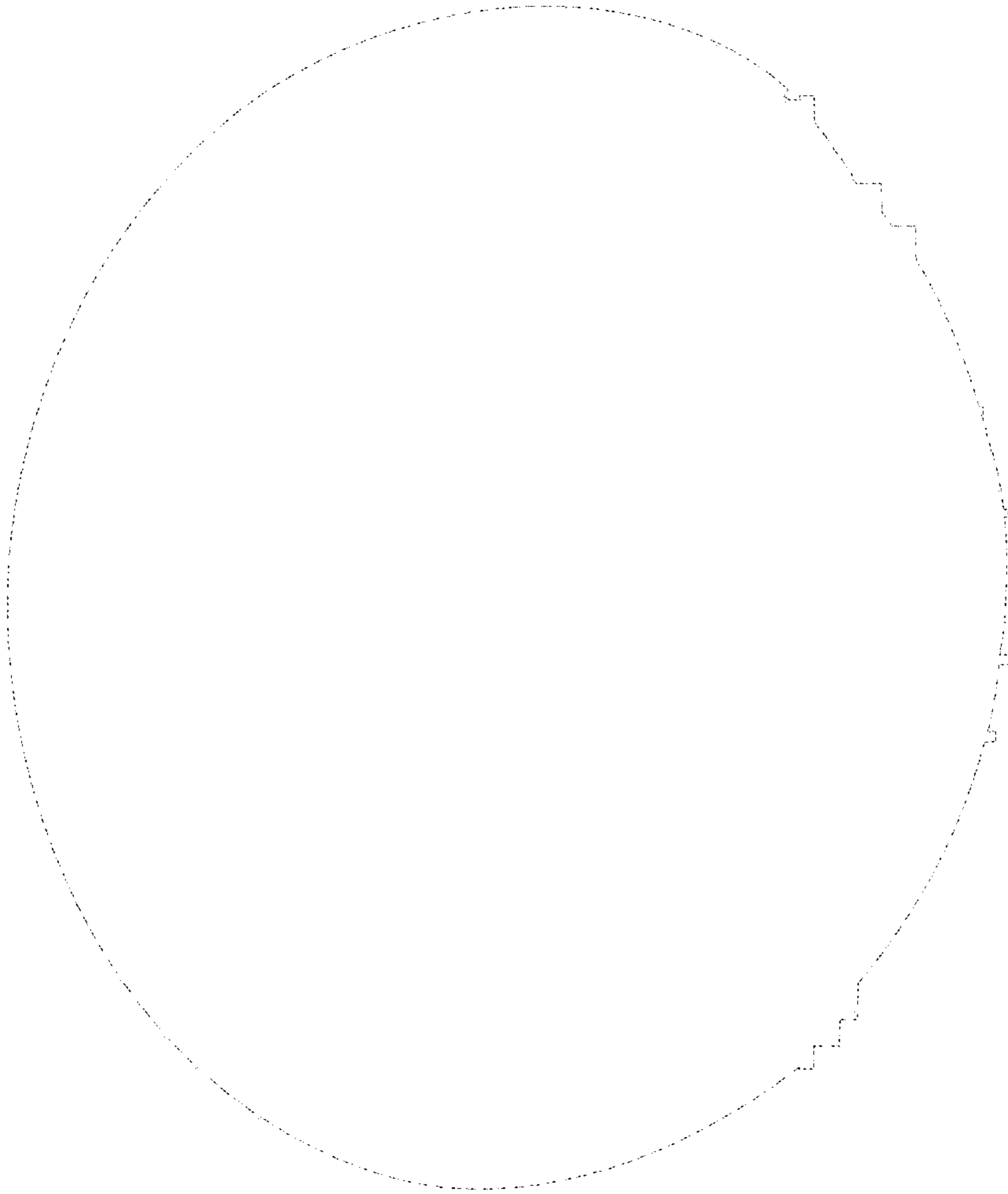

FIG. 3

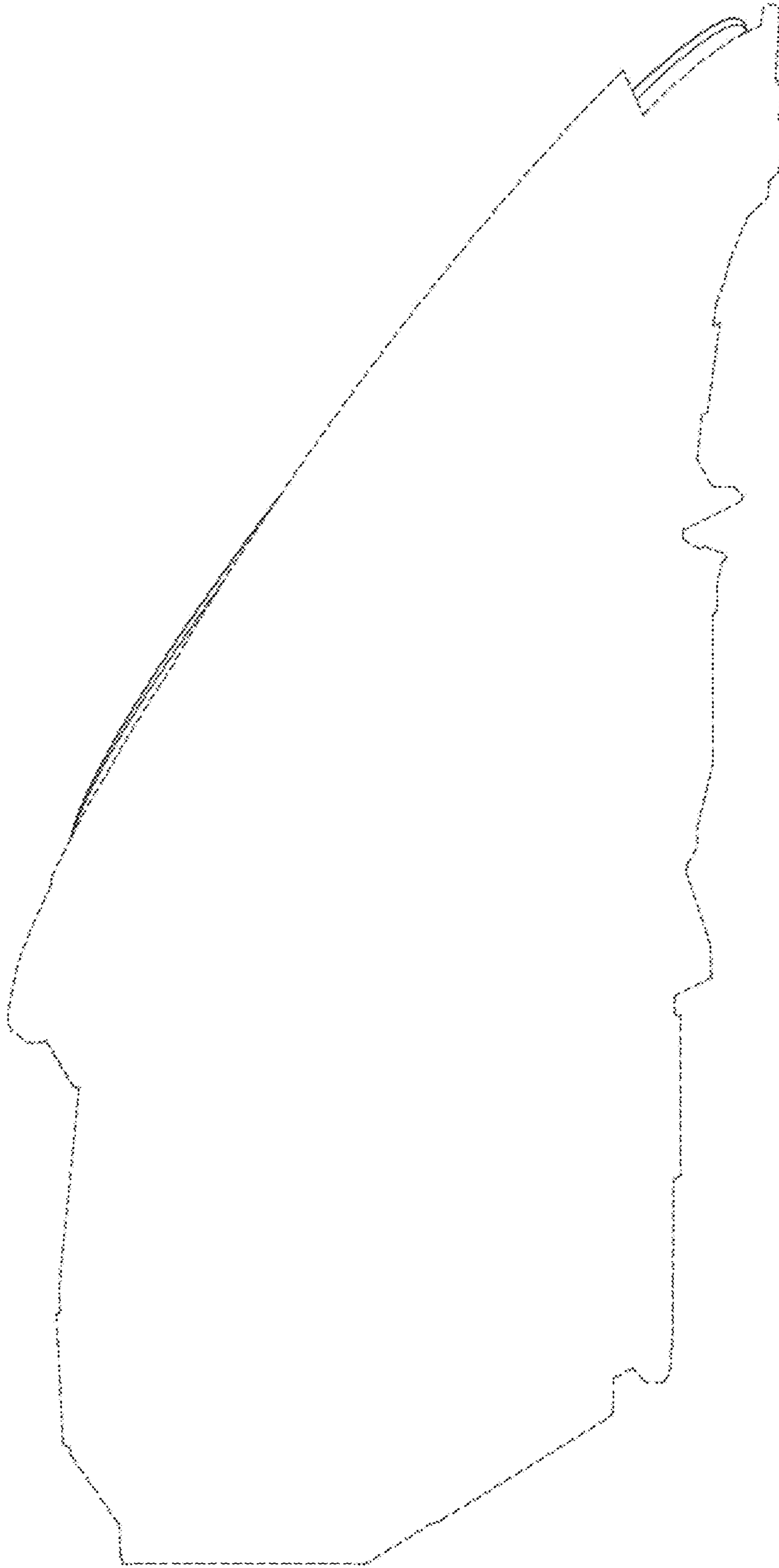

FIG. 4

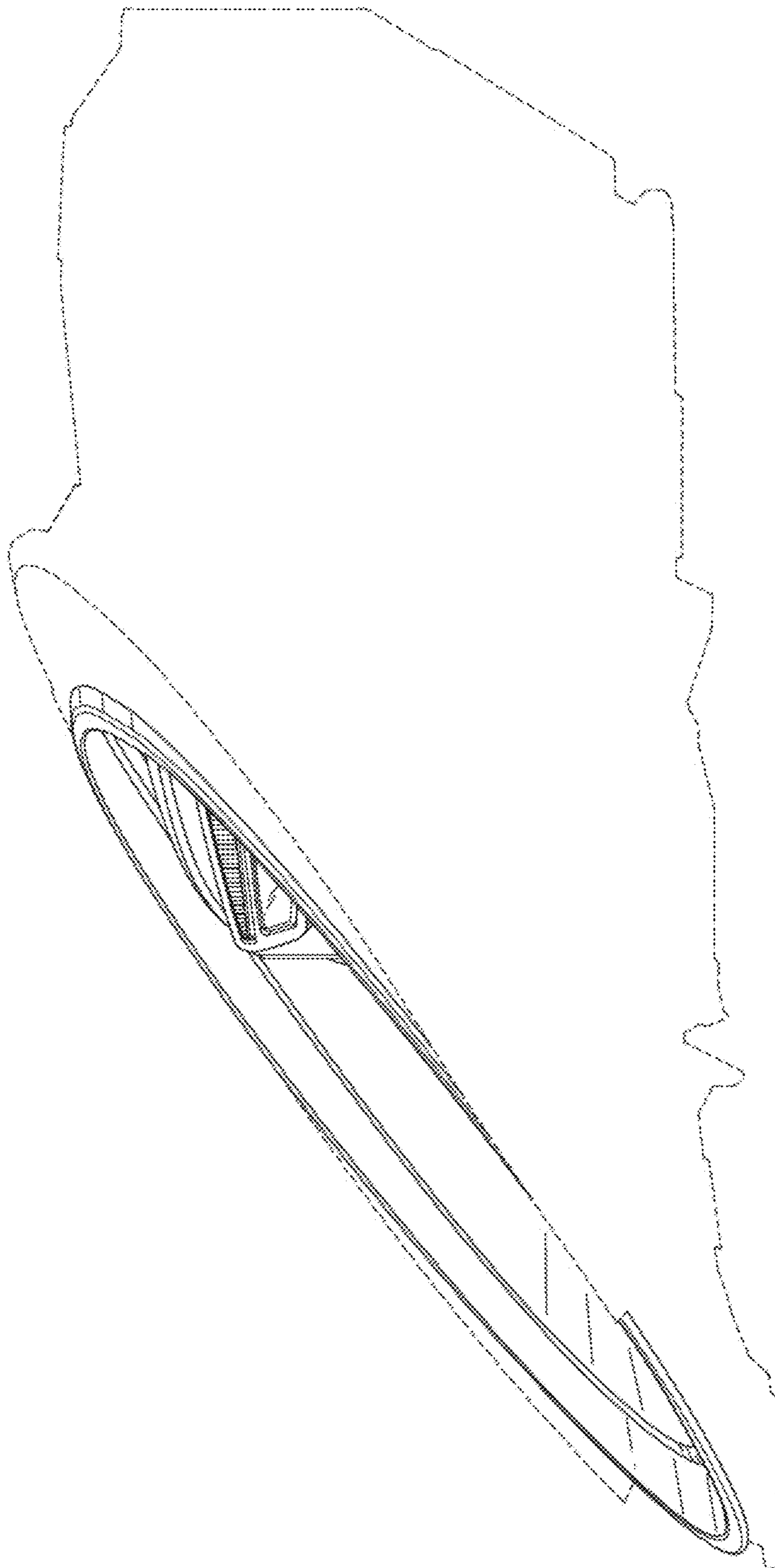

FIG. 5

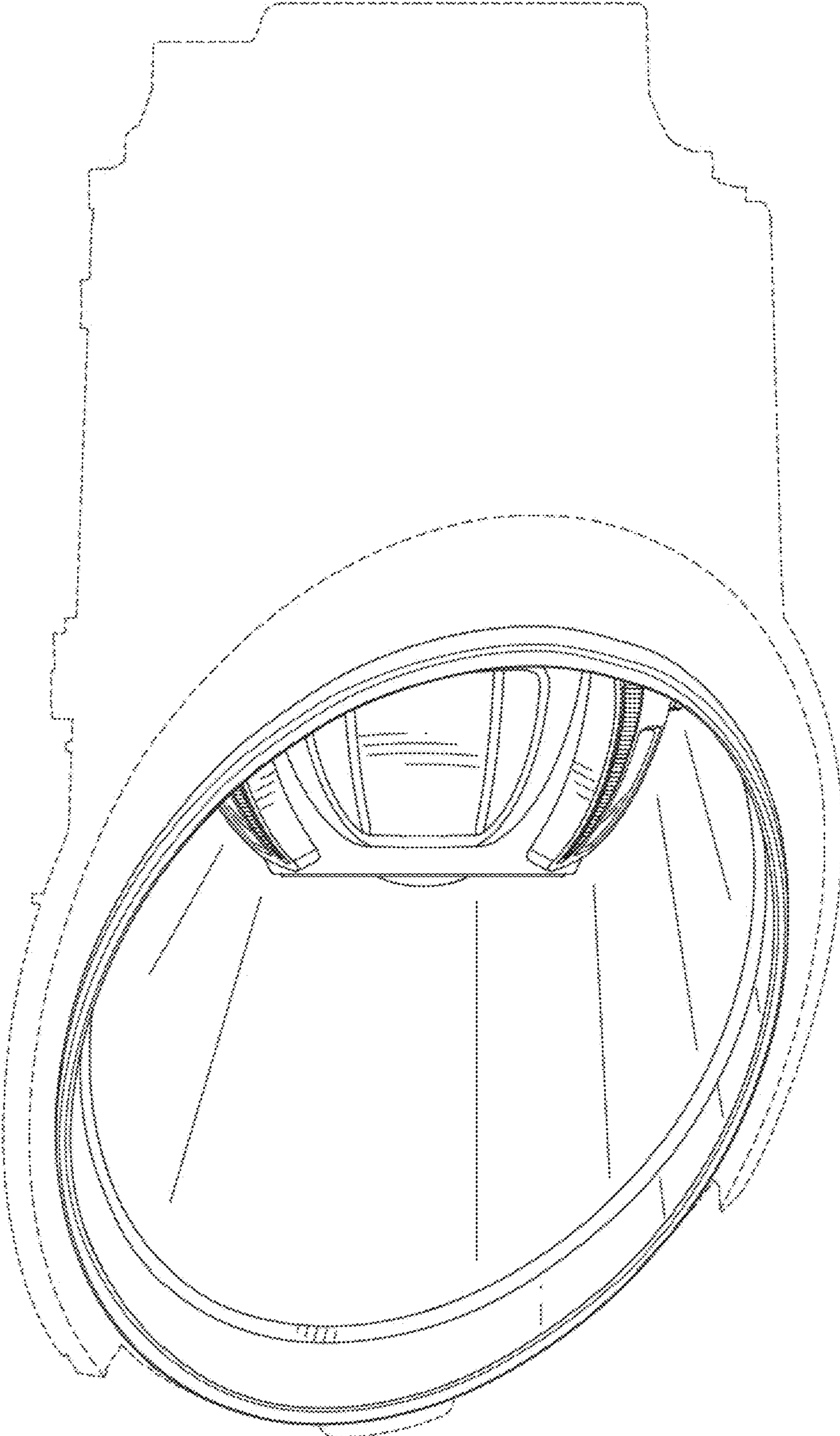

FIG. 6

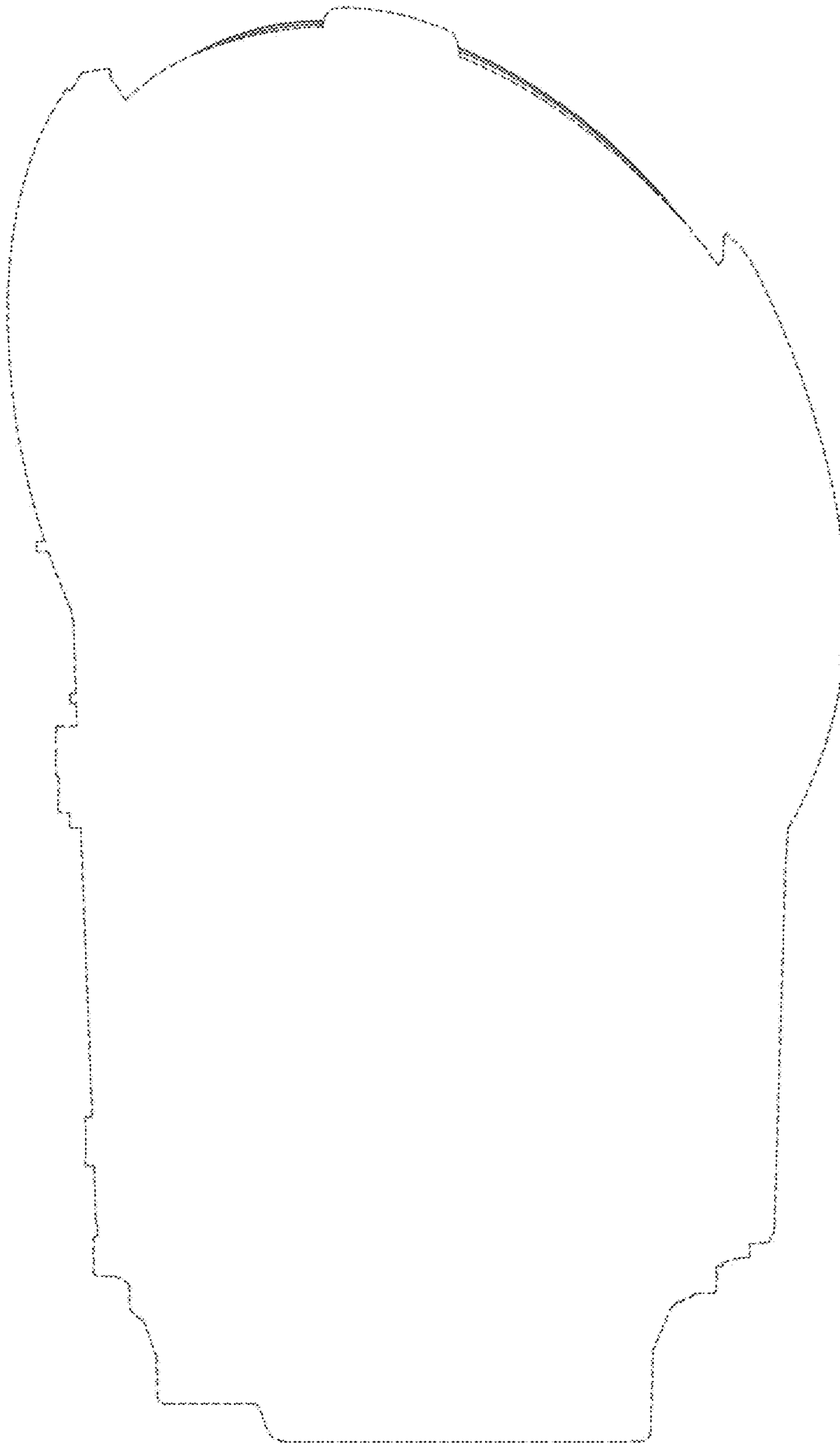

FIG. 7