



US00D979671S

(12) **United States Design Patent** (10) **Patent No.:** **US D979,671 S**
Pellegrino (45) **Date of Patent:** **** Feb. 28, 2023**

(54) **CROSSFIT GYMNASTICS GRIP**

FOREIGN PATENT DOCUMENTS

(71) Applicant: **VICTORY GRIPS LLC**, Tybee Island, GA (US)

JP 1684025 4/2021

(72) Inventor: **Victor Brian Pellegrino**, Tybee Island, GA (US)

OTHER PUBLICATIONS

“Fit Vikings” Jun. 19, 2017, Amazon, site visited Dec. 9, 2022: <https://amzn.to/3BpZbJn> (Year: 2017).*

(73) Assignee: **VICTORY GRIPS LLC**, Tybee Island, GA (US)

(Continued)

(**) Term: **15 Years**

Primary Examiner — Jack Reickel

Assistant Examiner — Salamah Jordan

(21) Appl. No.: **29/794,358**

(74) *Attorney, Agent, or Firm* — Fish & Richardson P.C.

(22) Filed: **Jun. 11, 2021**

(57) **CLAIM**

The ornamental design for a crossfit gymnastics grip, as shown and described.

(51) **LOC (14) Cl.** **21-02**

DESCRIPTION

(52) **U.S. Cl.**

USPC **D21/684**; D2/610

(58) **Field of Classification Search**

USPC D2/610, 611, 617, 619; D29/113, 114, D29/117.1, 117.2, 120.1; D21/684, 797

CPC A41D 13/08; A41D 19/00; A41D 20/00; A41D 13/088

See application file for complete search history.

FIG. 1 is a perspective view of an open configuration of my crossfit gymnastics grip.

FIG. 2 is a front view thereof.

FIG. 3 is a back view thereof.

FIG. 4 is a left side view thereof.

FIG. 5 is a right side view thereof.

FIG. 6 is a top view thereof.

FIG. 7 is a bottom view thereof.

FIG. 8 is a perspective view of a closed configuration of my crossfit gymnastics grip.

FIG. 9 is a front view thereof.

FIG. 10 is a back view thereof.

FIG. 11 is a left side view thereof.

FIG. 12 is a right side view thereof.

FIG. 13 is a top view thereof; and,

FIG. 14 is a bottom view thereof.

The dotted dash lines shown in the figures are for the purpose of showing stitching, which form no part of the claimed design. The broken lines in each figure illustrate graphical environmental features that form no part of the claimed design.

(56) **References Cited**

U.S. PATENT DOCUMENTS

2,391,851	A	12/1945	Donald
3,344,436	A	10/1967	Stubbs
3,411,159	A	11/1968	Berkhemer
3,421,160	A	1/1969	Domenico
3,670,574	A	6/1972	Edwards
3,779,550	A	12/1973	Benoun et al.
4,183,100	A	1/1980	De Marco
4,281,389	A	7/1981	Smith
D270,556	S	9/1983	Kneisley
4,441,490	A	4/1984	Nirschl
4,487,412	A	12/1984	Meeko
4,504,980	A	3/1985	Butcher
4,519,097	A	5/1985	Chappell, Jr. et al.

(Continued)

1 Claim, 8 Drawing Sheets

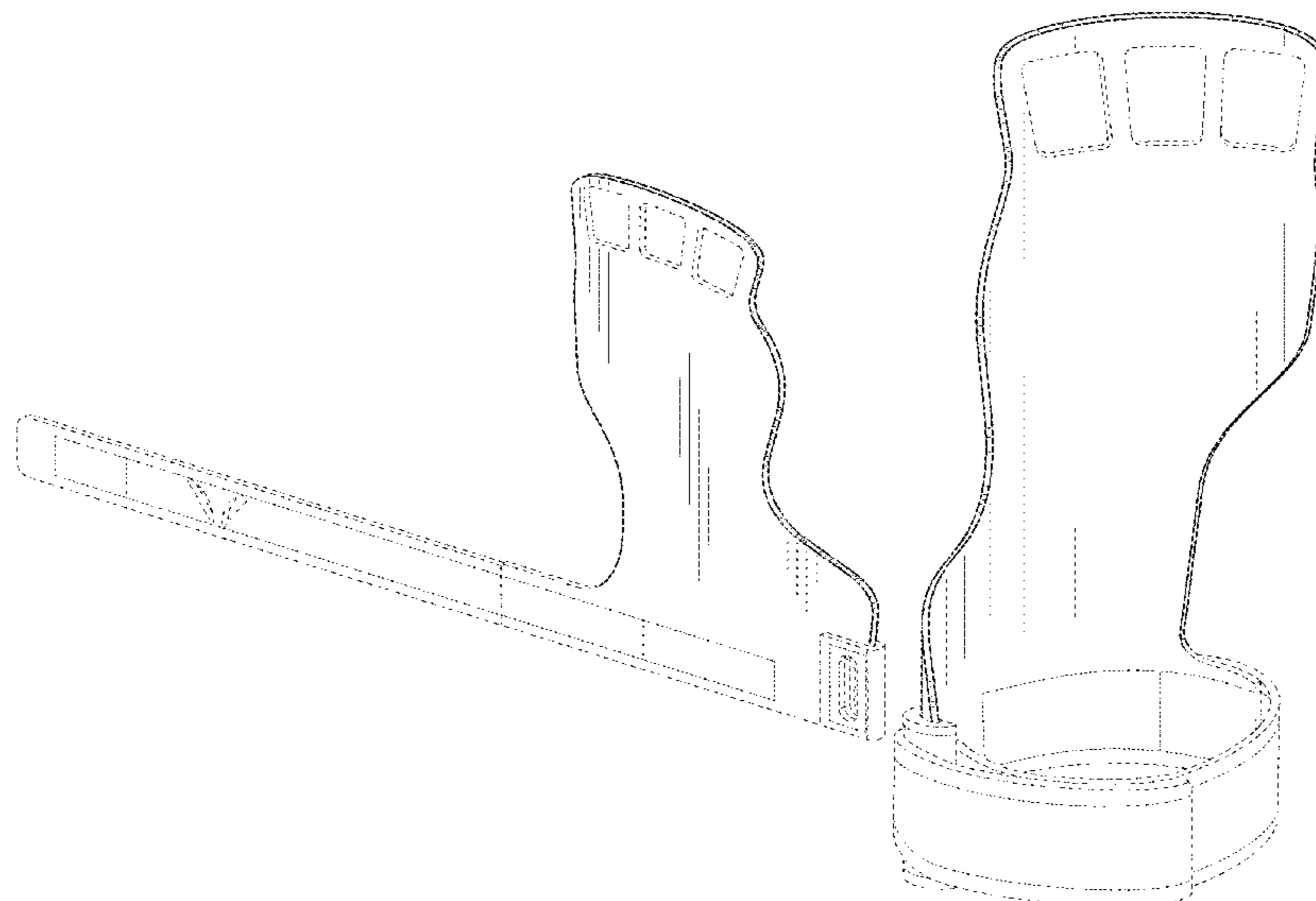

(56)

References Cited

U.S. PATENT DOCUMENTS

4,531,241 A 7/1985 Berger
 4,584,993 A 4/1986 Nelson
 D285,821 S 9/1986 Kneisley
 4,807,876 A 2/1989 Lothar
 4,809,974 A 3/1989 Buhr
 4,977,621 A 12/1990 Richard
 D320,872 S 10/1991 McCrane
 D351,930 S 10/1994 Snider et al.
 5,447,490 A 9/1995 Fula et al.
 5,479,660 A 1/1996 Najac
 5,538,501 A 7/1996 Caswell
 D387,503 S * 12/1997 Ho D2/610
 5,704,883 A 1/1998 Eckmann
 5,781,928 A 7/1998 Avila
 D396,936 S 8/1998 Liss-Daniels
 5,898,944 A 5/1999 Vranj
 D412,048 S 7/1999 Schiazza
 6,013,044 A 1/2000 Estwanik
 6,098,200 A 8/2000 Minkow et al.
 6,142,966 A 11/2000 Hely
 6,146,319 A 11/2000 Tarail
 6,168,556 B1 1/2001 Saavedra
 D437,682 S 2/2001 Steele
 D450,795 S 11/2001 Riley, Jr.
 6,581,211 B1 6/2003 Golden
 6,694,523 B2 2/2004 Hurst
 D502,573 S 3/2005 Jones
 6,988,998 B1 1/2006 Santaana-Dela Rosa
 7,086,094 B1 8/2006 Ismailyan
 D528,263 S * 9/2006 Van Trojen D2/610
 D603,581 S 11/2009 Rimando
 7,713,223 B2 5/2010 Weber et al.
 8,029,414 B2 10/2011 Ingvast et al.
 D654,228 S 2/2012 Burry et al.
 8,137,296 B2 3/2012 Chaing et al.
 D675,397 S 2/2013 Bengyak
 8,425,438 B2 4/2013 Fujimoto et al.
 8,529,483 B2 9/2013 Farrow et al.
 8,657,771 B2 2/2014 Weaver et al.
 8,702,634 B2 4/2014 Crompton
 8,747,284 B2 6/2014 Ingram
 D716,287 S 10/2014 Ambriz
 8,870,725 B2 10/2014 Harris
 8,876,667 B2 11/2014 Russotti
 8,966,666 B2 3/2015 Faulconer
 D739,992 S 10/2015 Fischer et al.
 D752,695 S * 3/2016 Boruch D21/684
 9,643,073 B1 5/2017 Pellegrino

D804,589 S 12/2017 Boruch
 D813,960 S 3/2018 Burch
 D824,112 S 7/2018 Picón
 D840,633 S 2/2019 Katopis
 D847,919 S 5/2019 Jhaveri
 D855,719 S * 8/2019 Rhodes D21/684
 D863,464 S * 10/2019 Rhodes D29/117.1
 D873,936 S 1/2020 Pellegrino
 D880,780 S * 4/2020 Jarvis D29/117.1
 D881,299 S 4/2020 Pellegrino
 D923,733 S 6/2021 Milgram
 D929,508 S * 8/2021 Conaway D29/117.1
 D955,687 S * 6/2022 Jenni D2/610
 2003/0154538 A1 8/2003 Murphy
 2006/0005296 A1 1/2006 Moore
 2008/0120755 A1 5/2008 Ingram et al.
 2012/0005805 A1 1/2012 Bevier et al.
 2013/0061368 A1 3/2013 Filippone
 2014/0189932 A1 7/2014 Joffe et al.
 2016/0074740 A1 3/2016 Sekhon
 2017/0056713 A1 3/2017 Abdourazak
 2017/0202282 A1 7/2017 Dwars
 2017/0348584 A1 12/2017 Rhodes et al.
 2018/0055108 A1 3/2018 Long et al.
 2018/0140929 A1 5/2018 Pellegrino
 2019/0037938 A1 2/2019 Hong

OTHER PUBLICATIONS

“JerkFit” Jun. 13, 2018, Amazon, site visited Dec. 9, 2022: <https://amzn.to/3Y3xO1o> (Year: 2018).
 affenhand.de [online], “Victory Grips Premium Hand Protection Women,” upon information and belief, available no later than Jan. 30, 2021, accessed on Nov. 22, 2022, retrieved from URL <www.affenhand.de/produkt/victory-grips-premium-handschutz-damen/>, 38 pages (with machine translation).
 [No Author Listed] [online], “Victory Grips Freedom & 2 Finger Grips Review,” May 5, 2018, retrieved on Mar. 21, 2022, retrieved from URL <<https://www.youtube.com/watch?v=VxiZqIuVtZQ>>, 11 pages.
 [No Author Listed] [online], “3 vs 4-Finger Grips | Victory Grips,” Mar. 15, 2019, retrieved on Sep. 21, 2022, <<https://www.youtube.com/watch?v=DZhHA8bCu0M>>, 3 pages [Video Submission].
 [No Author Listed] [online], “Victory Grips Tactical Grips Review,” Aug. 29, 2019, retrieved on Sep. 21, 2022, <<https://www.youtube.com/watch?v=IxHbnaYqjWA>>, 3 pages [Video Submission].
 [No Author Listed] [online], “Which Victory Grip Style is Best For Me?” Aug. 23, 2019, retrieved on Sep. 21, 2022, <<https://www.youtube.com/watch?v=b1SK4jrtUVk>>, 3 pages [Video Submission].

* cited by examiner

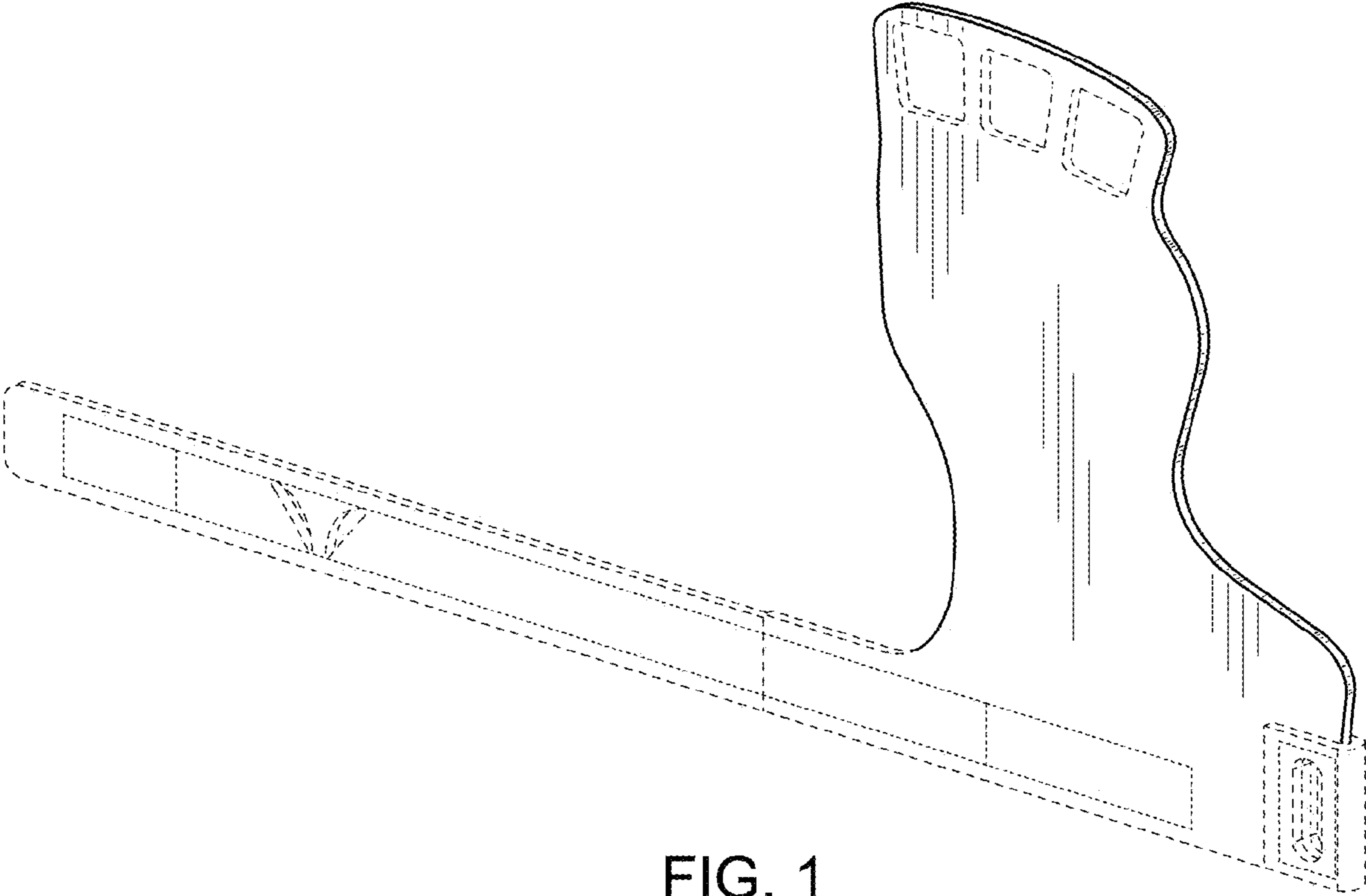

FIG. 1

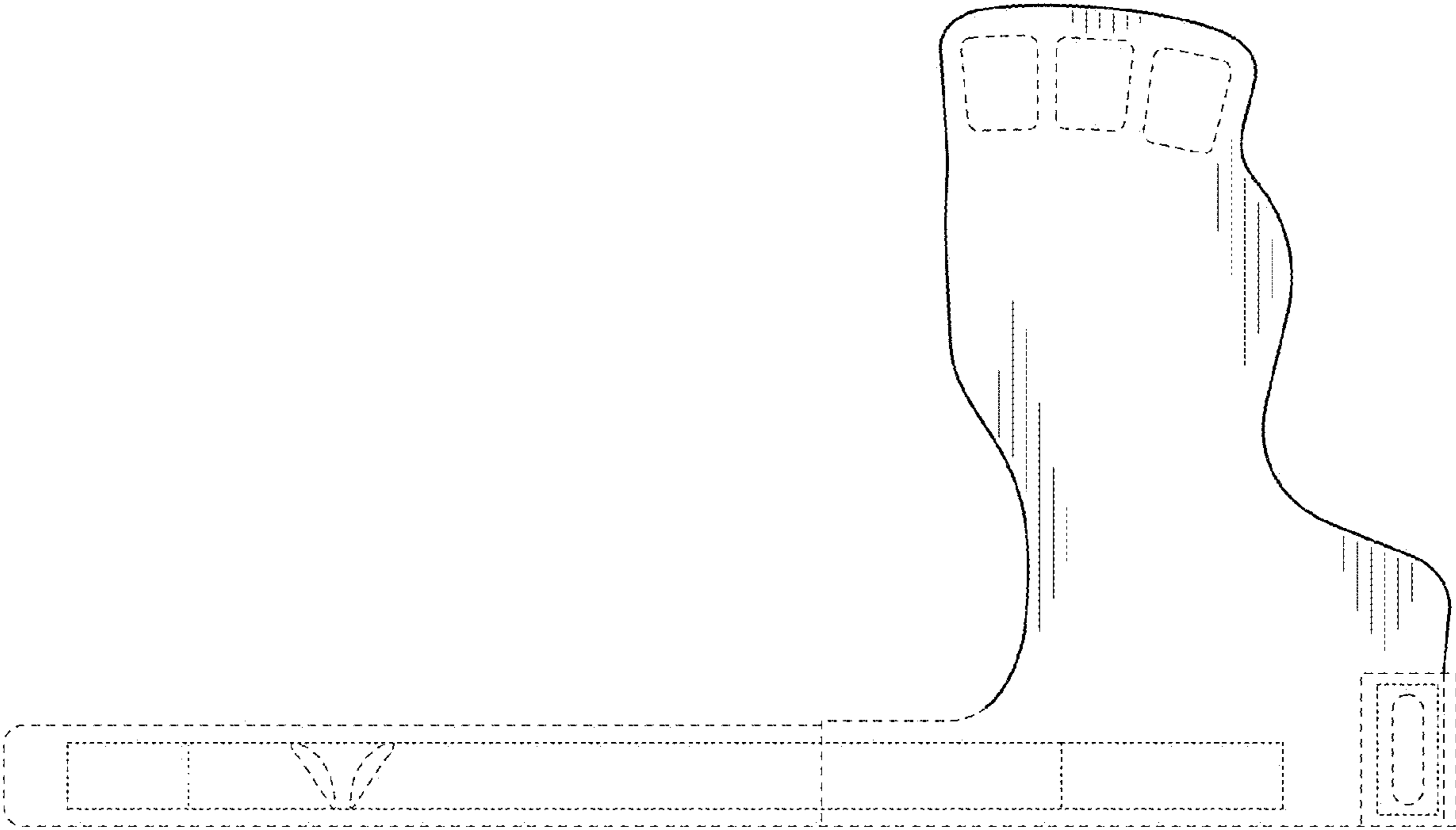

FIG. 2

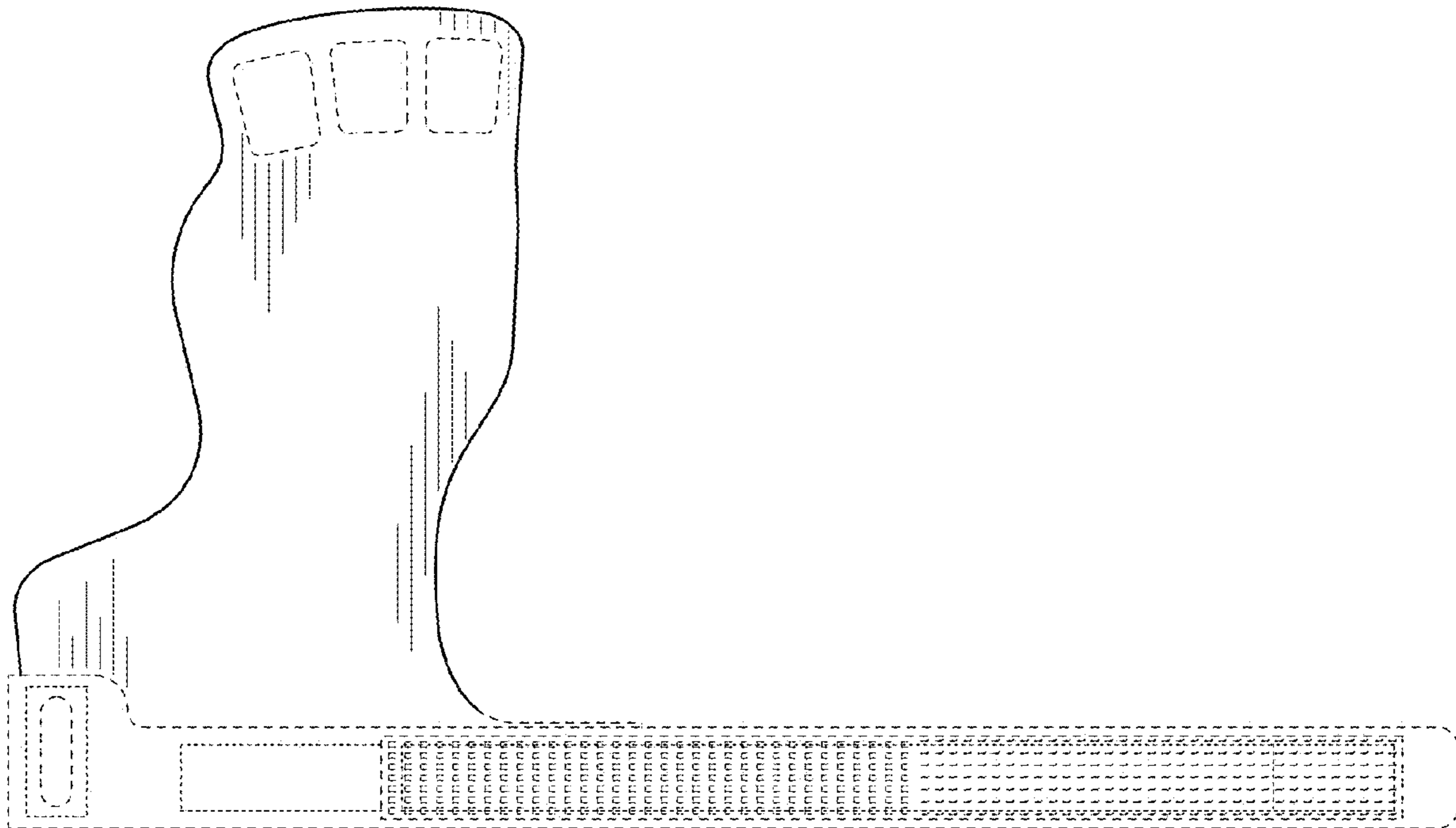

FIG. 3

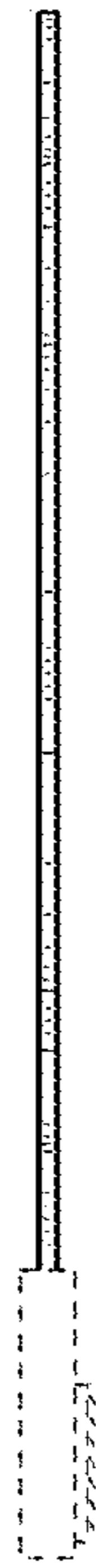

FIG. 4



FIG. 5

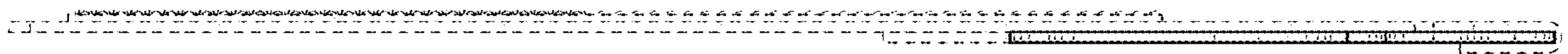

FIG. 6

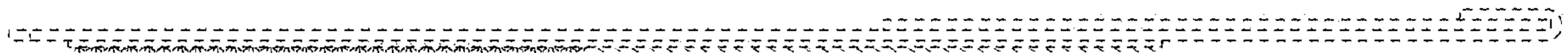

FIG. 7

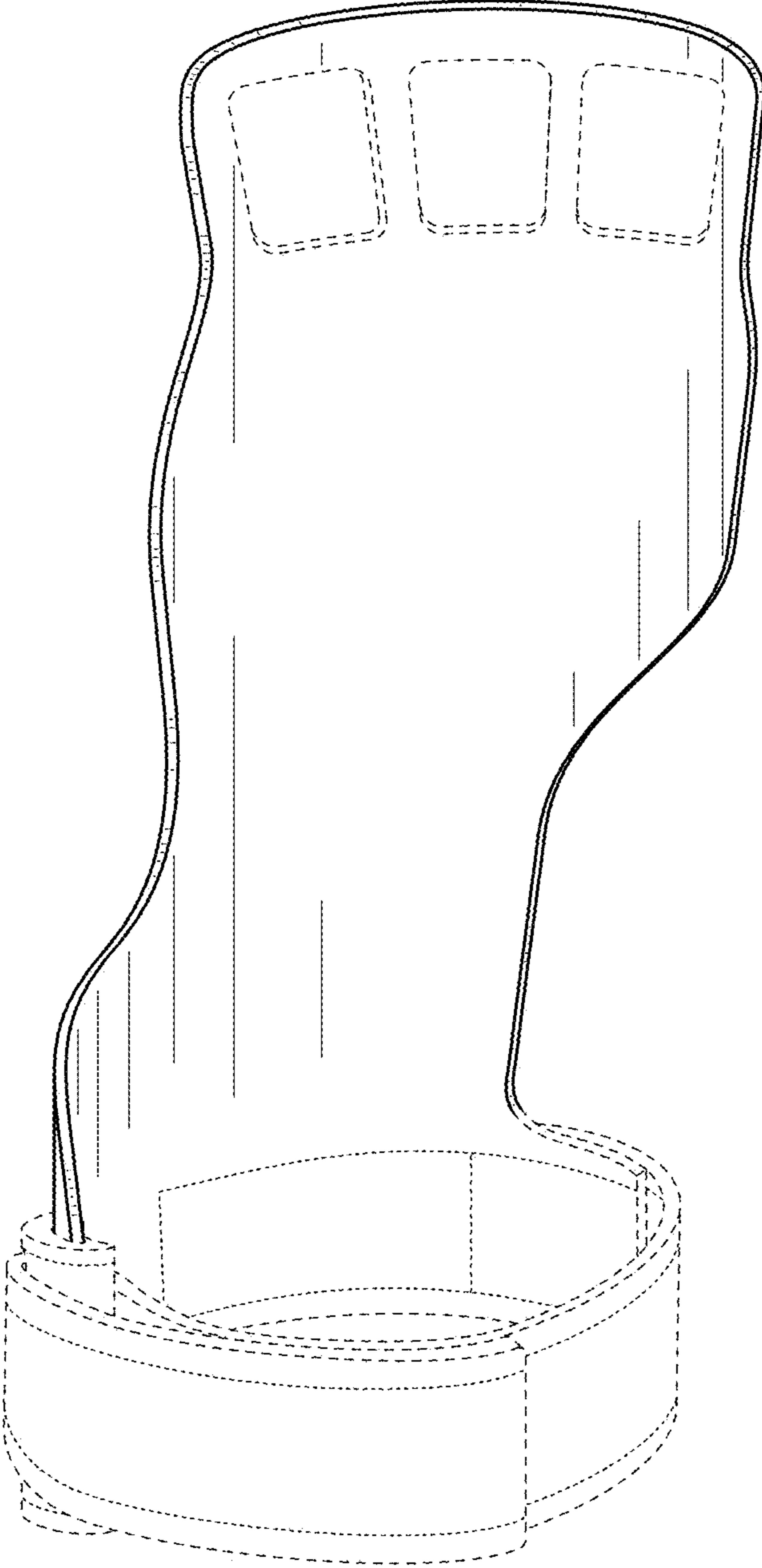

FIG. 8

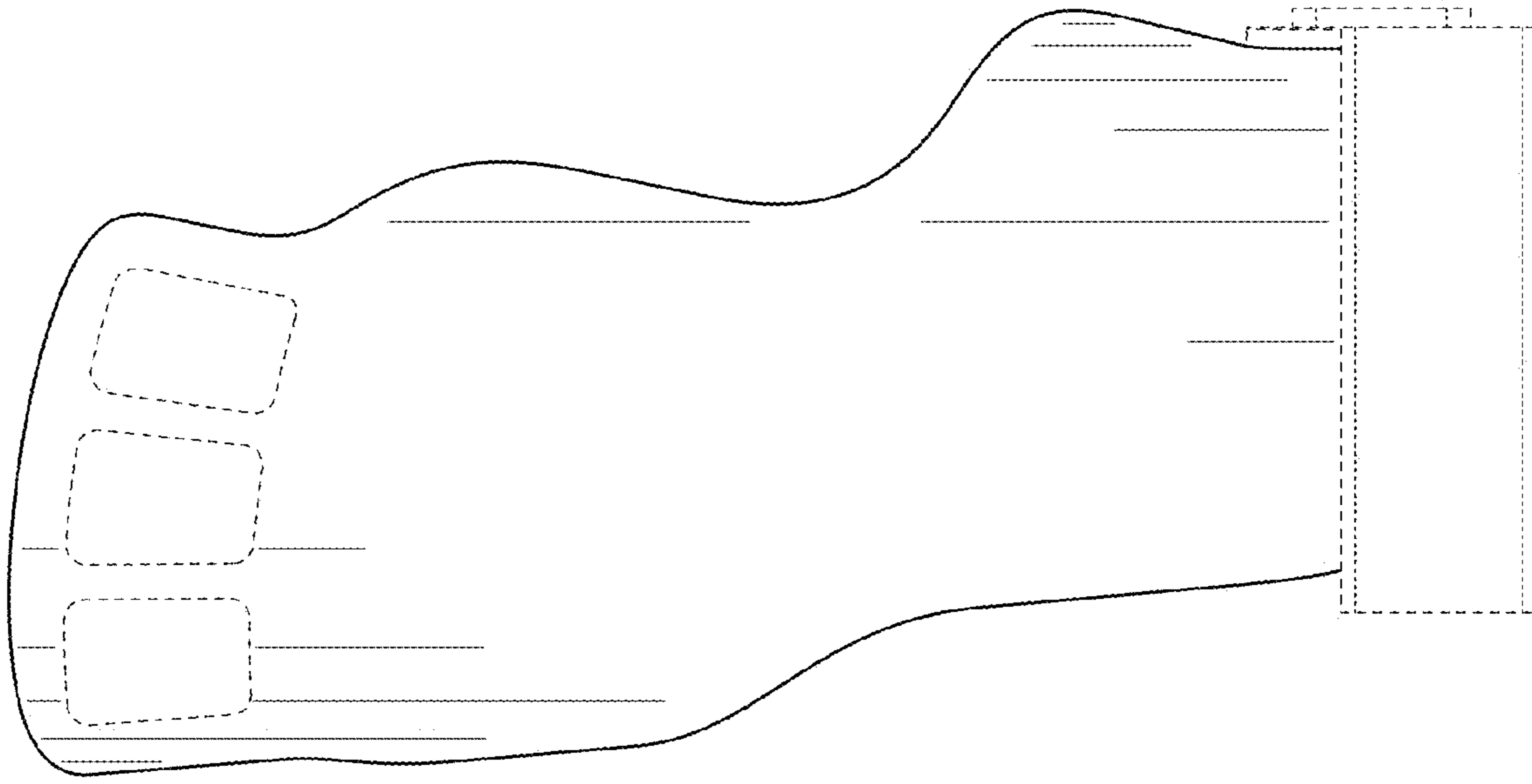

FIG. 9

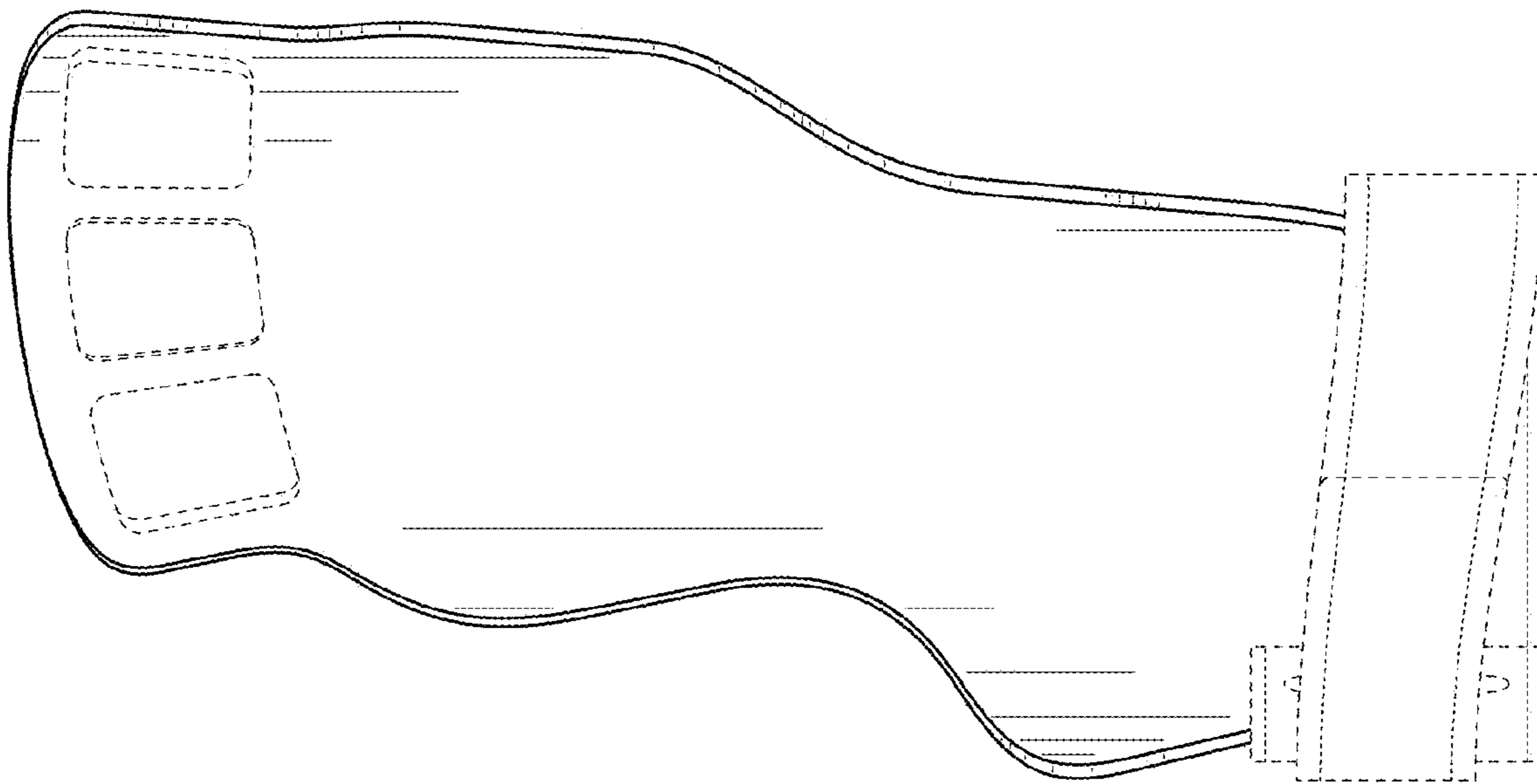

FIG. 10

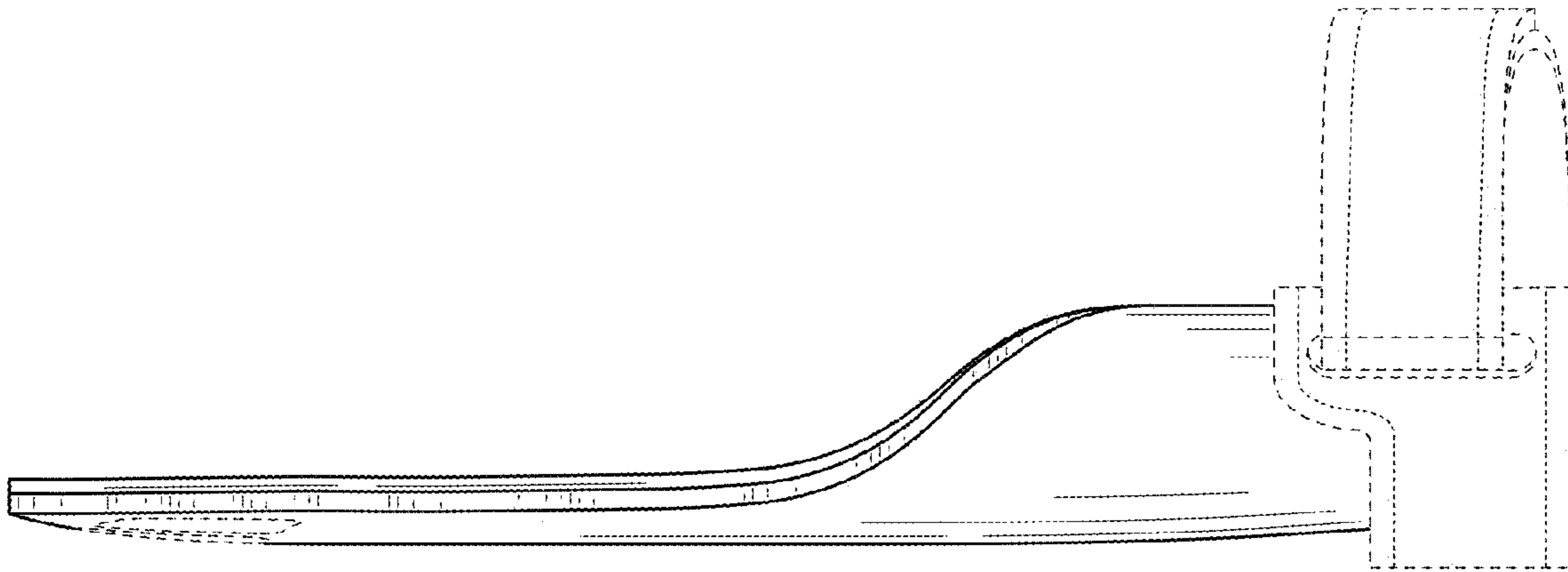

FIG. 12

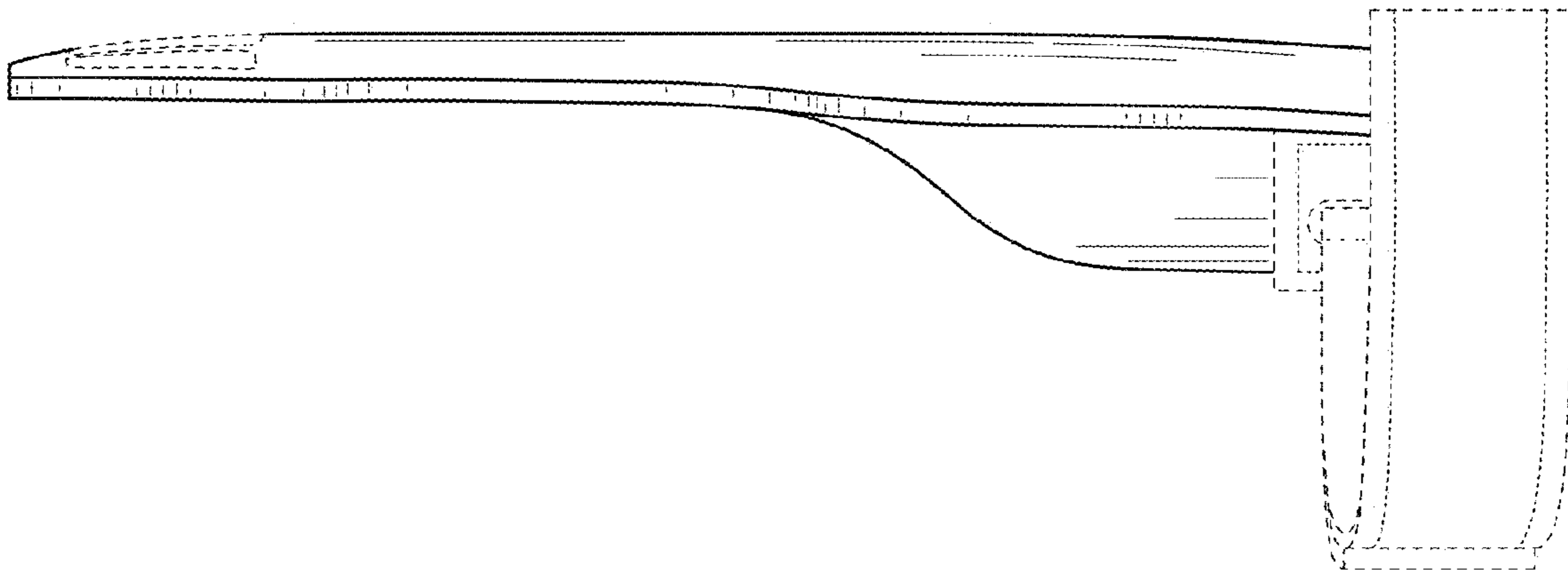

FIG. 11

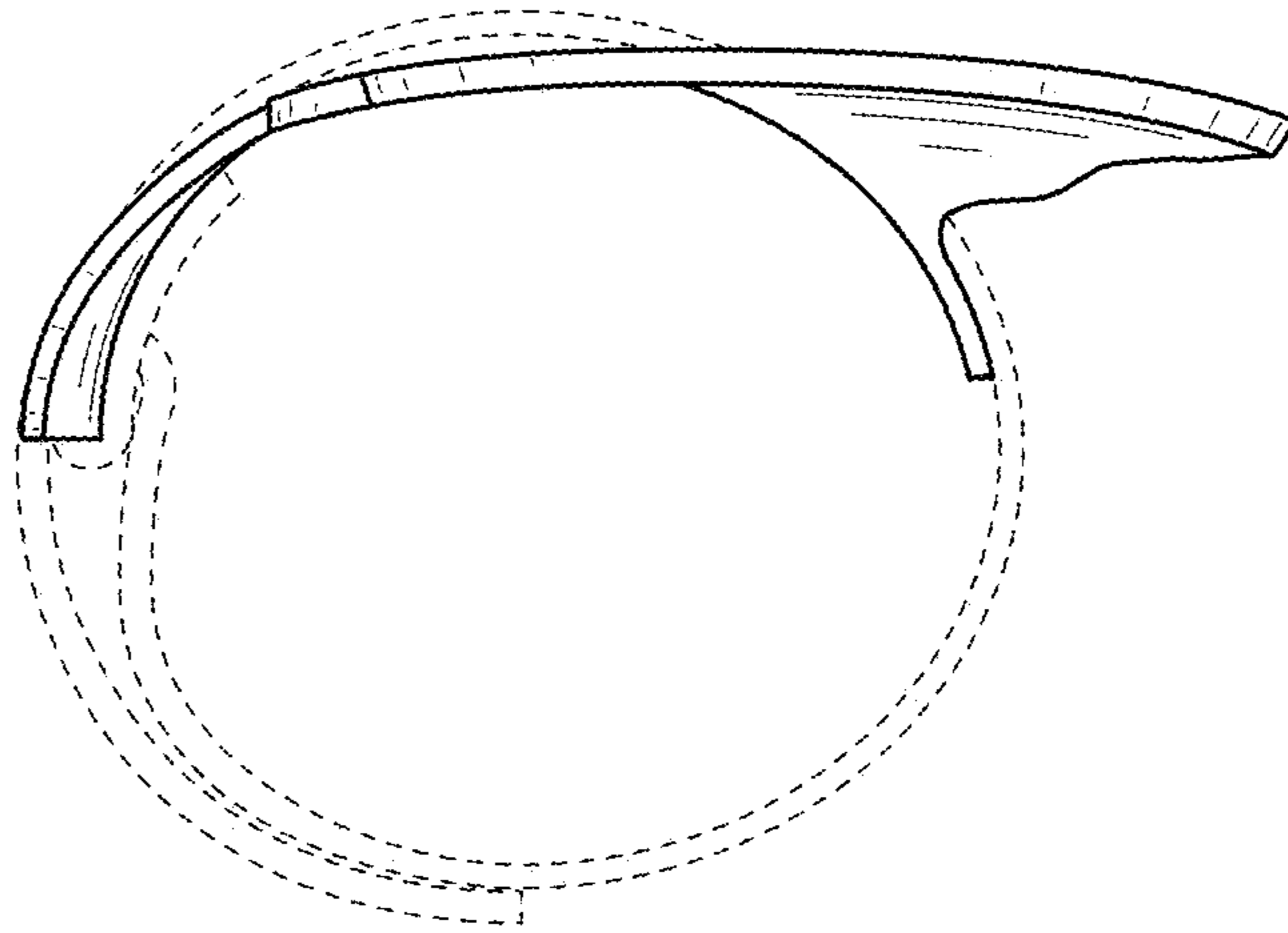

FIG. 13

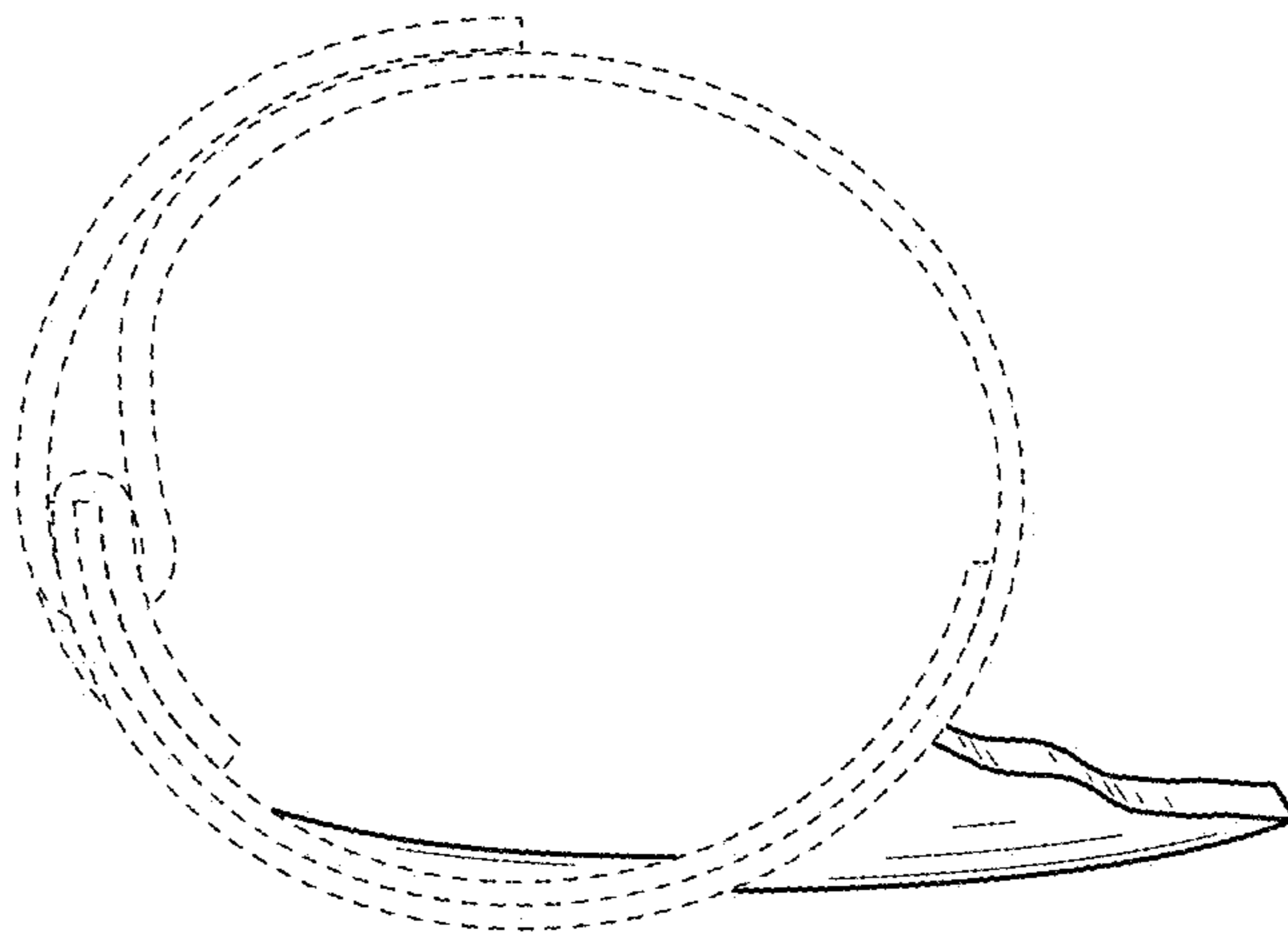

FIG. 14