



US00D979412S

(12) **United States Design Patent**
Hutchins

(10) **Patent No.:** **US D979,412 S**

(45) **Date of Patent:** **** Feb. 28, 2023**

(54) **CONTAINER**

(71) Applicant: **Luma Suncare, Inc.**, Malibu, CA (US)

(72) Inventor: **Sophia Loretta Hutchins**, Malibu, CA (US)

(73) Assignee: **Luma Suncare, Inc.**, Malibu, CA (US)

(**) Term: **15 Years**

(21) Appl. No.: **29/730,509**

(22) Filed: **Apr. 6, 2020**

(51) **LOC (14) Cl.** **09-01**

(52) **U.S. Cl.**
USPC **D9/521**

(58) **Field of Classification Search**
USPC D9/519, 530, 531, 537, 539, 540,
D9/544-545, 549, 574
CPC B65D 1/02; B65D 1/0223; B65D 1/023;
B65D 1/0261; B65D 2501/0009; B65D
2501/0081; B65D 2501/009
See application file for complete search history.

(56) **References Cited**

U.S. PATENT DOCUMENTS

- 4,393,974 A * 7/1983 Levesque A45C 11/22
206/811
- D327,009 S * 6/1992 Poore D9/503
- D378,733 S * 4/1997 Asaff D28/7
- D658,362 S * 5/2012 Nassiri D3/203.2
- D658,993 S * 5/2012 Gill D9/500

- D691,480 S * 10/2013 Shukla D9/503
- D751,908 S * 3/2016 Lee D9/503
- D839,095 S * 1/2019 Fux D9/503
- D839,096 S * 1/2019 Fux D9/503
- D844,434 S * 4/2019 Toribio D9/500
- D931,730 S * 9/2021 Suid D9/504
- D932,104 S * 9/2021 Fornarelli D28/85

* cited by examiner

Primary Examiner — Janice Patyk

(74) *Attorney, Agent, or Firm* — Schwegman Lundberg & Woessner, P.A.

(57) **CLAIM**

The ornamental design for a container, as shown and described.

DESCRIPTION

FIG. 1 is a front view of a container, showing my new design;
 FIG. 2 is a rear view thereof;
 FIG. 3 is a left side view thereof;
 FIG. 4 is a right side view thereof;
 FIG. 5 is a top view thereof;
 FIG. 6 is a bottom view thereof;
 FIG. 7 is a top, front, left side perspective view thereof;
 FIG. 8 is a bottom, front, right side perspective view thereof;
 FIG. 9 is a top, rear, right side perspective view thereof; and,
 FIG. 10 is a bottom, rear, left side perspective view thereof.
 The word “lumasol” in the drawings forming a part of the claimed design is a registered trademark of Luma Suncare, Inc.

1 Claim, 5 Drawing Sheets

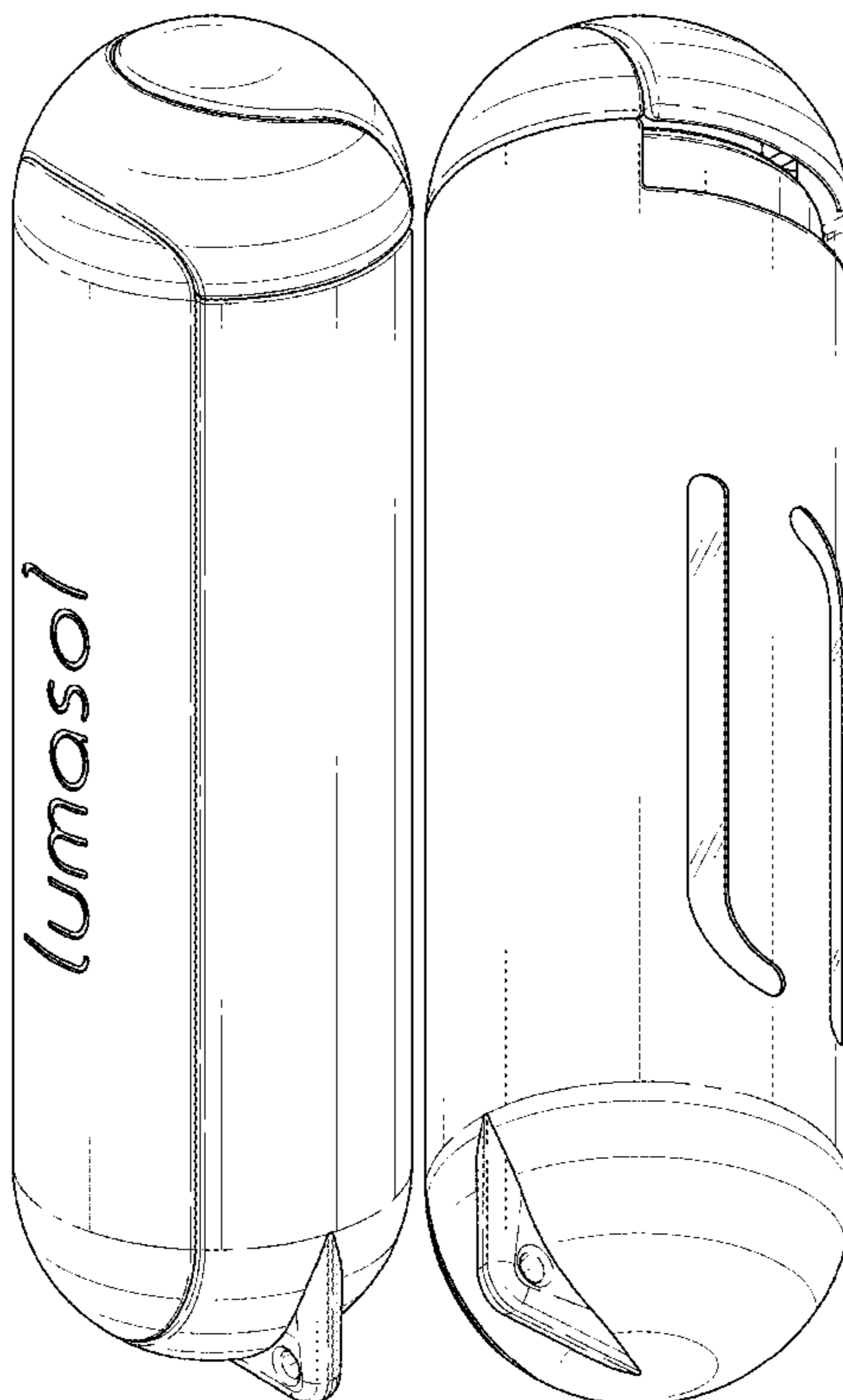

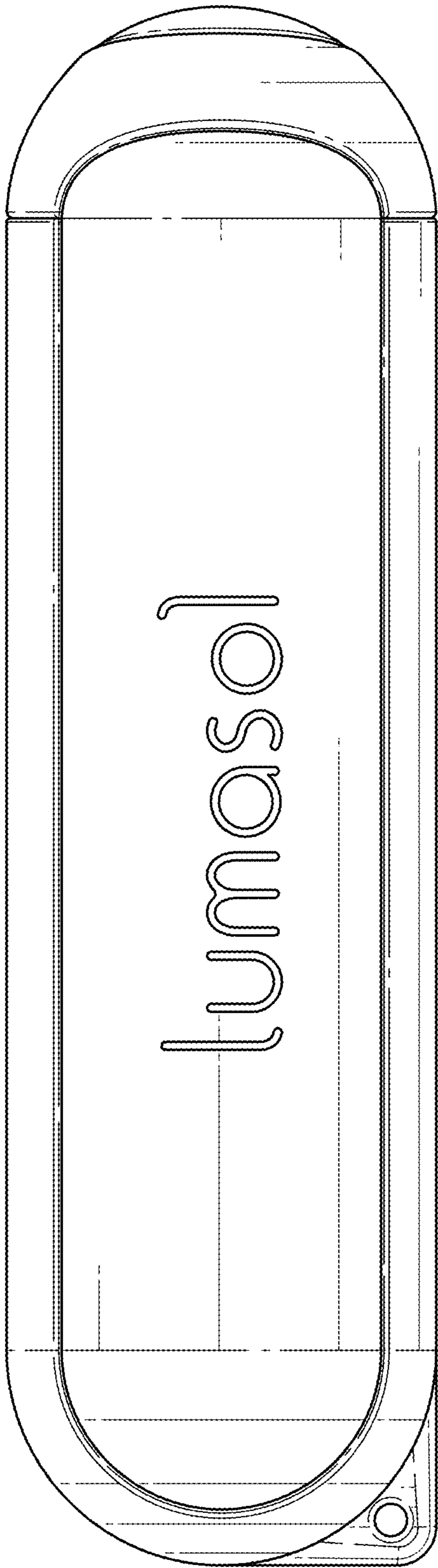

FIG. 1

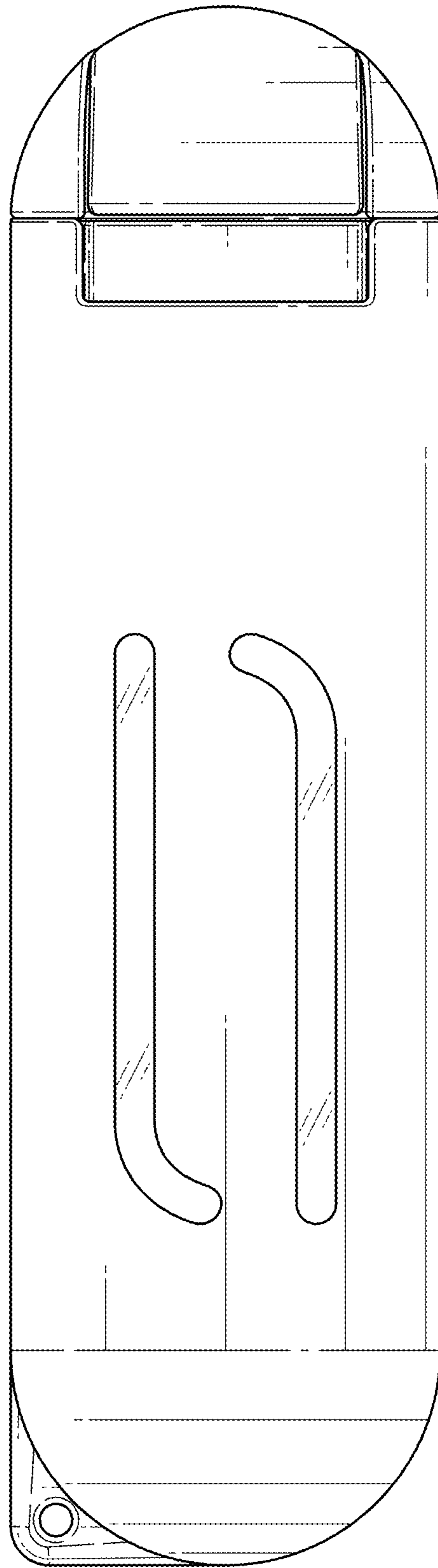

FIG. 2

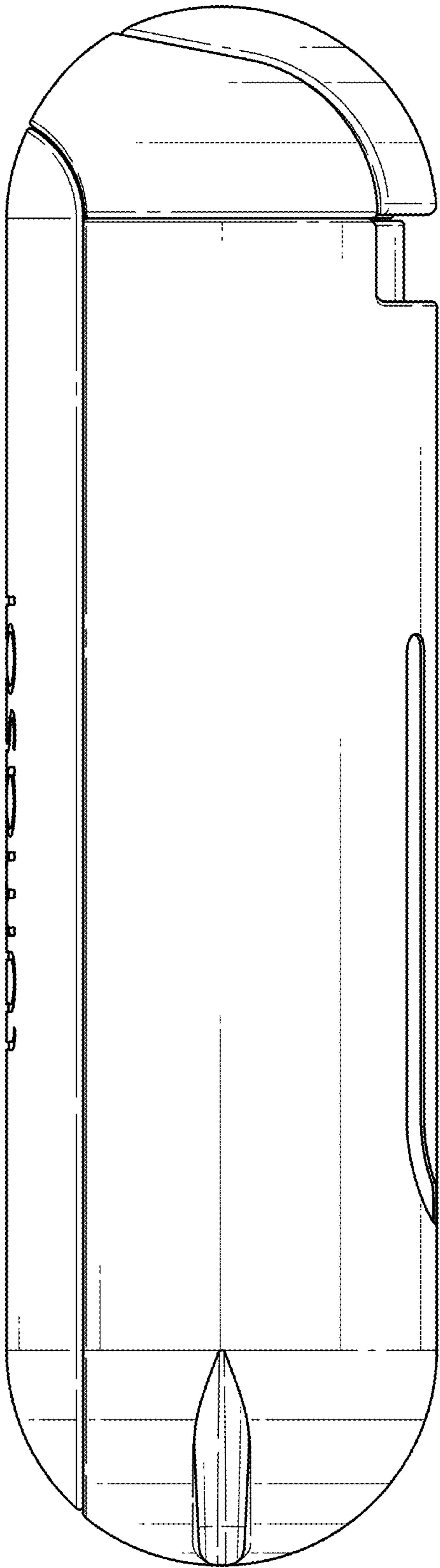

FIG. 3

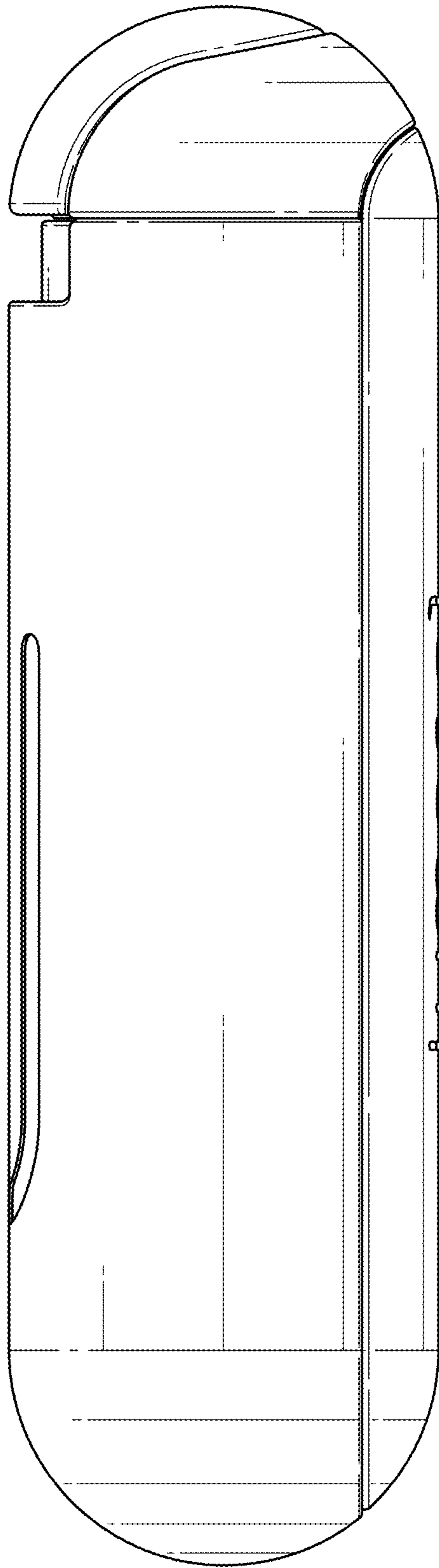

FIG. 4

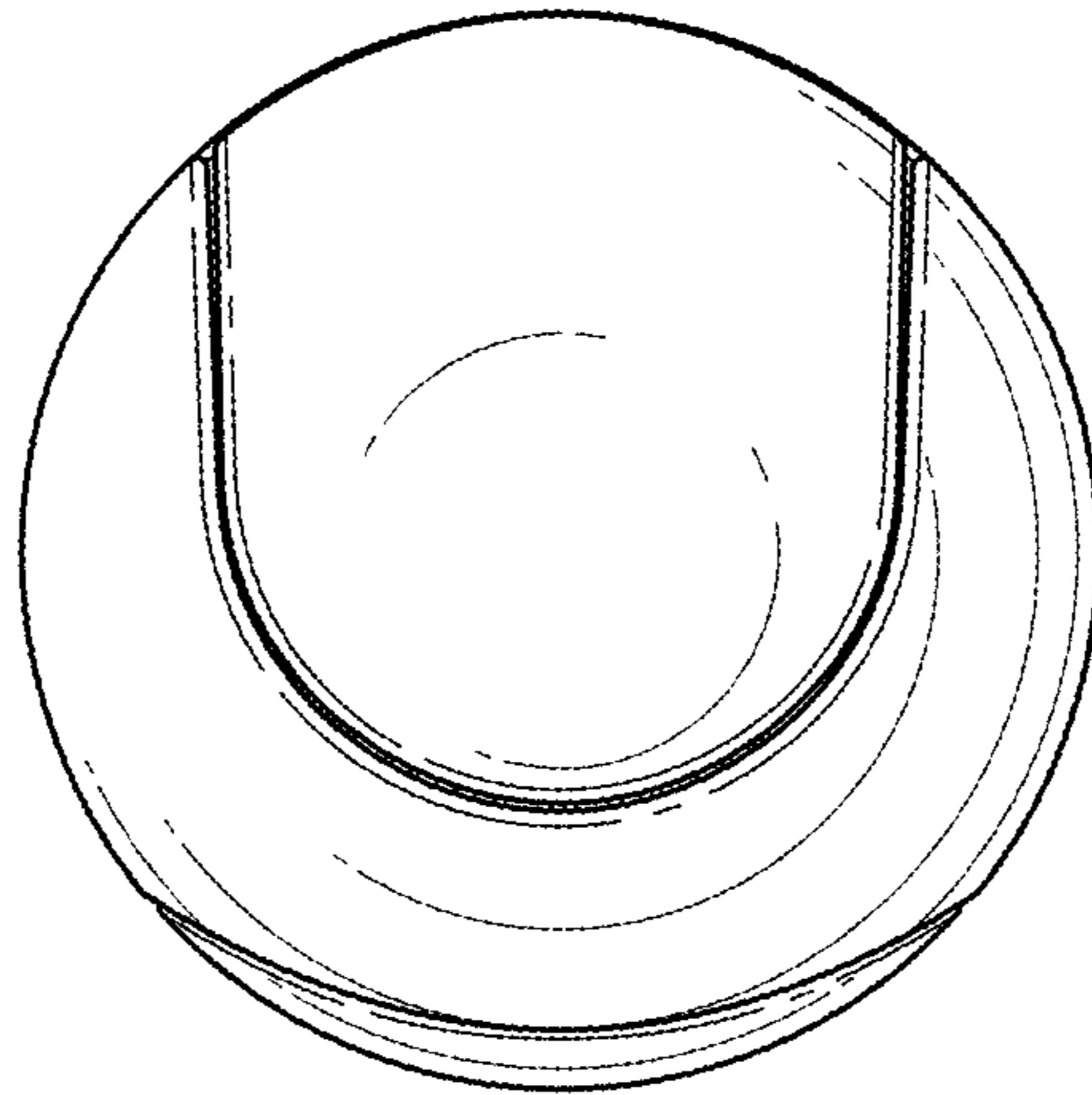

FIG. 5

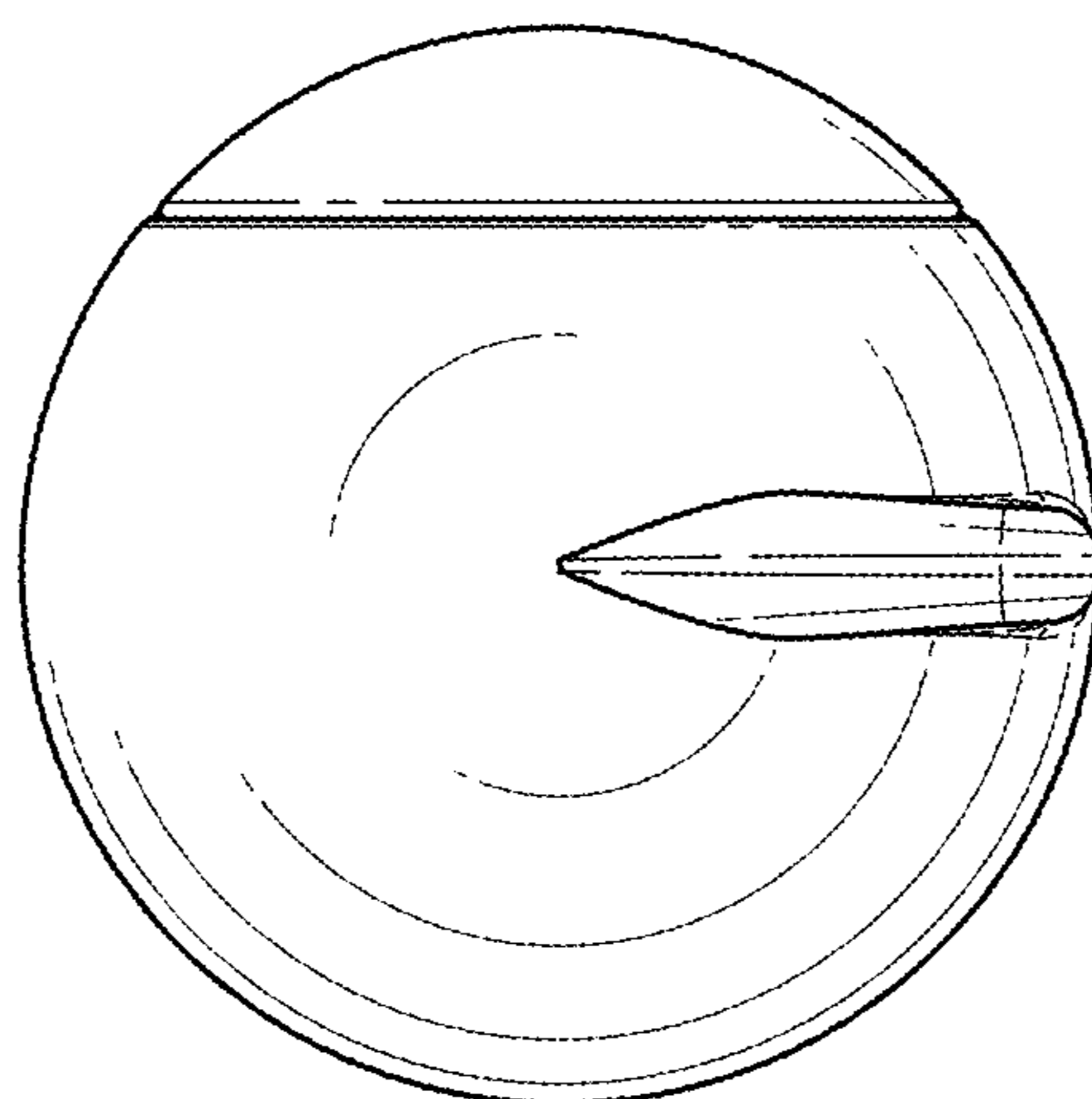

FIG. 6

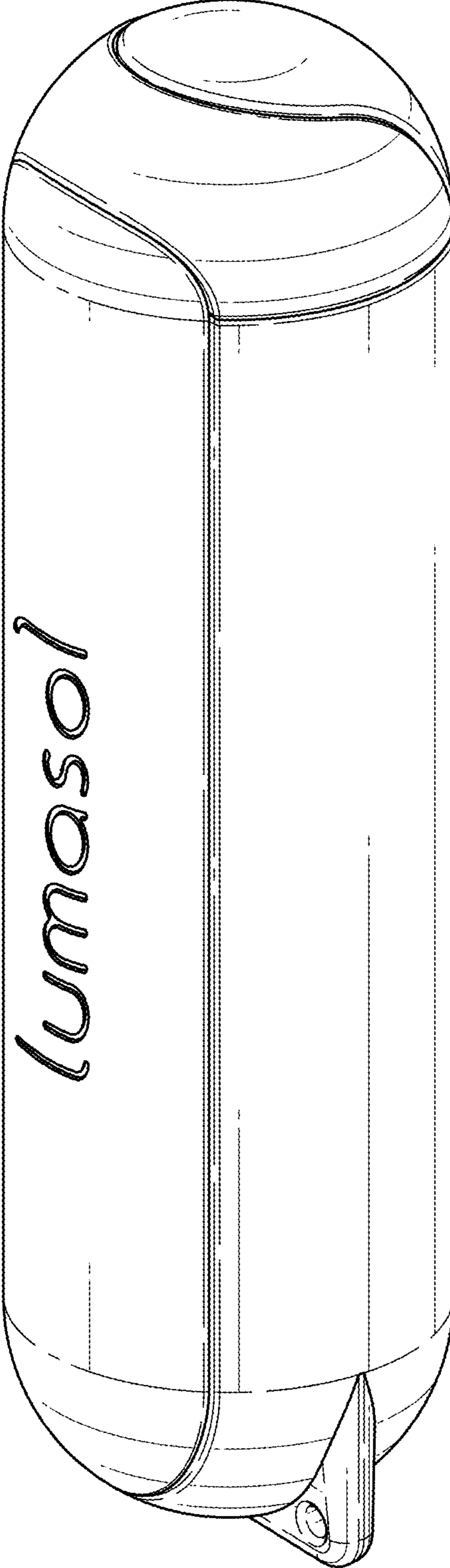

FIG. 7

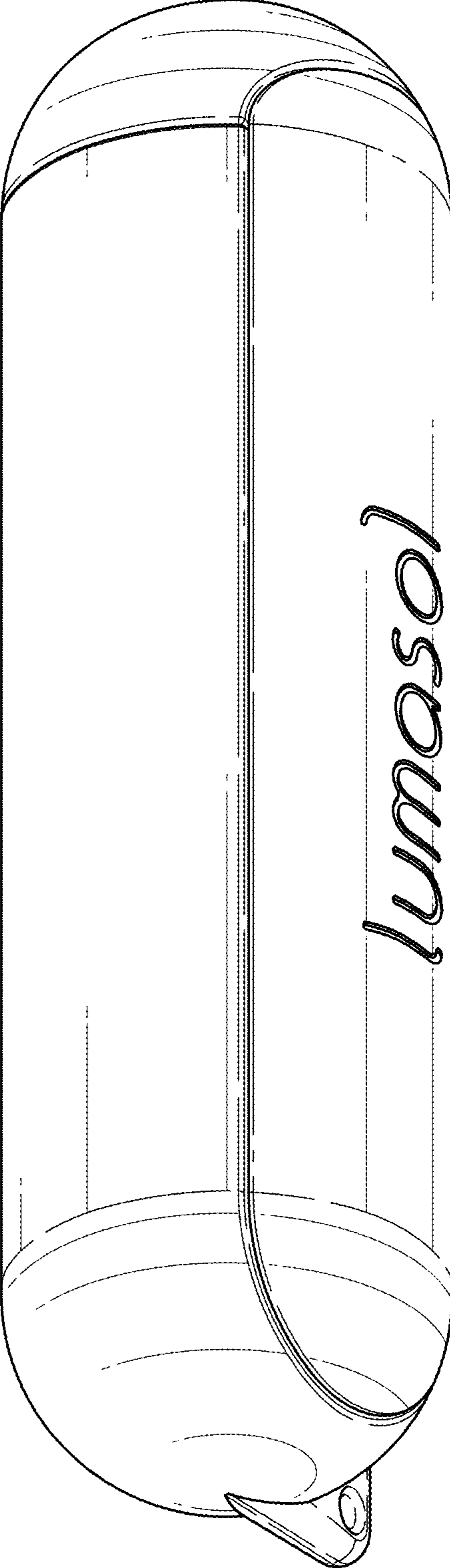

FIG. 8

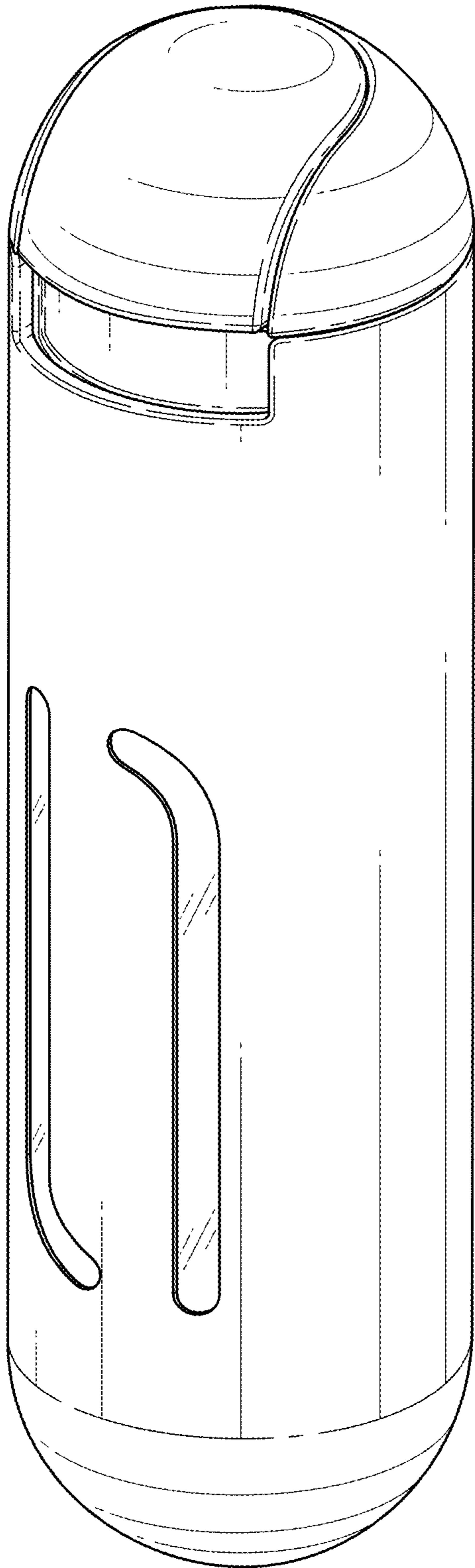

FIG. 9

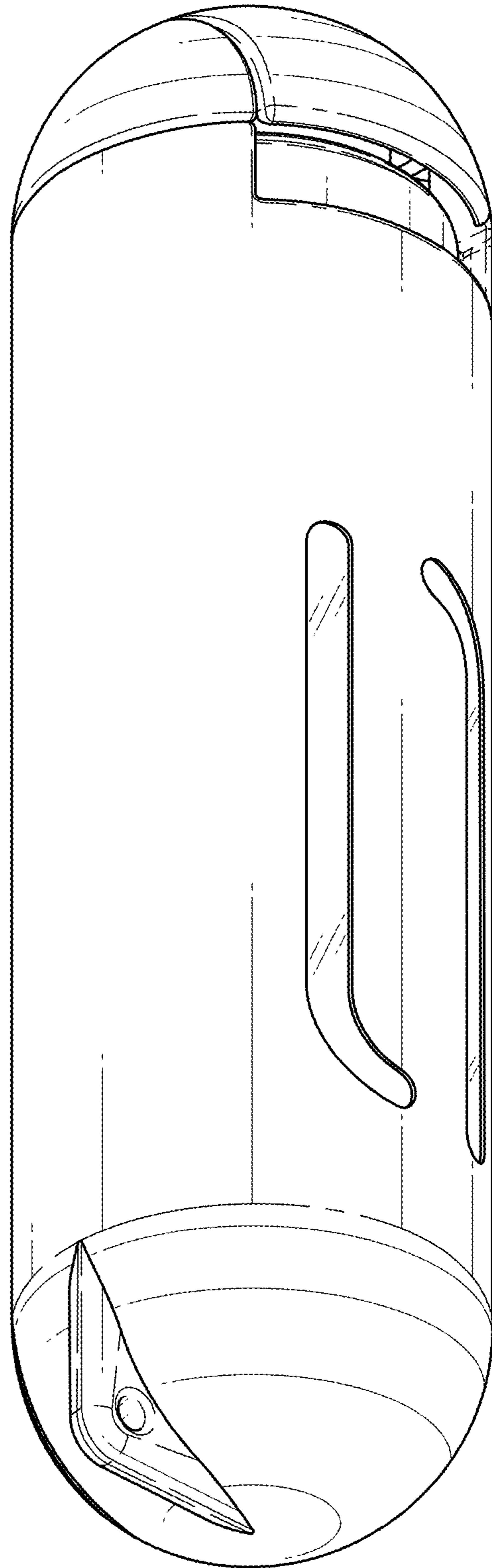

FIG. 10

UNITED STATES PATENT AND TRADEMARK OFFICE
CERTIFICATE OF CORRECTION

PATENT NO. : D979,412 S
APPLICATION NO. : 29/730509
DATED : February 28, 2023
INVENTOR(S) : Sophia Loretta Hutchins

Page 1 of 1

It is certified that error appears in the above-identified patent and that said Letters Patent is hereby corrected as shown below:

On the Title Page

In item (73), in "Assignee", in Column 1, Line 1, delete "Ine.," and insert --Inc.,-- therefor

Signed and Sealed this
Thirtieth Day of May, 2023
Katherine Kelly Vidal

Katherine Kelly Vidal
Director of the United States Patent and Trademark Office