



US00D979366S

(12) **United States Design Patent**
Poppek

(10) **Patent No.:** **US D979,366 S**

(45) **Date of Patent:** **** Feb. 28, 2023**

(54) **SCISSORS**

(71) Applicant: **Lothar Pierre Poppek**, Tolar, TX (US)

(72) Inventor: **Lothar Pierre Poppek**, Tolar, TX (US)

(**) Term: **15 Years**

(21) Appl. No.: **29/864,767**

(22) Filed: **Jun. 17, 2022**

D423,894 S	5/2000	Schmithorst	
D427,037 S	6/2000	Schmithorst	
D444,687 S *	7/2001	Olix	D8/57
D450,988 S *	11/2001	Olix	D8/57
D543,080 S *	5/2007	Haquin	D8/57
D554,459 S *	11/2007	Garland	D8/57
D644,079 S	8/2011	Vicari et al.	
D711,713 S *	8/2014	Albers	D8/57
9,393,705 B2	7/2016	Schmithorst	
D789,758 S *	6/2017	Scimone	D8/57
D863,011 S	10/2019	Poppek	
D887,805 S *	6/2020	Fleming	D8/51

(Continued)

Related U.S. Application Data

(62) Division of application No. 29/788,712, filed on Jul. 20, 2021, now Pat. No. Des. 955,837.

(51) **LOC (14) Cl.** **08-03**

(52) **U.S. Cl.**
USPC **D8/57**

(58) **Field of Classification Search**
USPC D8/51-58, 4-5, 14
CPC B26B 13/00; B26B 13/02; B26B 13/12
See application file for complete search history.

(56) **References Cited**

U.S. PATENT DOCUMENTS

D53,606 S	7/1919	Rauh	
2,136,414 A	11/1938	Clements	
D137,343 S *	2/1944	Schlesinger	D8/57
D137,412 S	3/1944	Storz	
D204,853 S *	5/1966	Cummings	606/174
D206,311 S *	11/1966	Eizenberg	D8/57
D281,104 S *	10/1985	Davison	D8/57
D304,673 S *	11/1989	Rose	D8/57
D310,714 S	9/1990	Dolwick	
5,153,997 A *	10/1992	Chiavaras	B26B 13/20 30/235
5,232,000 A *	8/1993	Chiavaras	B26B 13/20 83/13
D339,724 S *	9/1993	Brown, Jr.	D8/57
D365,878 S	1/1996	Blake	
D417,376 S	12/1999	Schmithorst	

Primary Examiner — Deanna L Pratt

(74) *Attorney, Agent, or Firm* — IPTechLaw

(57) **CLAIM**

The ornamental design for scissors, as shown and described.

DESCRIPTION

FIG. 1 is a front perspective view of a first scissor;
 FIG. 2 is a front view thereof;
 FIG. 3 is a rear view thereof;
 FIG. 4 is left side view thereof;
 FIG. 5 is right side view thereof;
 FIG. 6 is a top view thereof;
 FIG. 7 is a bottom view thereof;
 FIG. 8 is a rear perspective view thereof;
 FIG. 9 is a front perspective view of a second scissor;
 FIG. 10 is a front view thereof;
 FIG. 11 is a rear view thereof;
 FIG. 12 is left side view thereof;
 FIG. 13 is right side view thereof;
 FIG. 14 is a top view thereof;
 FIG. 15 is a bottom view thereof; and,
 FIG. 16 is a rear perspective view thereof.
 All broken lines represent unclaimed features of the article to which the design is applied.

1 Claim, 12 Drawing Sheets

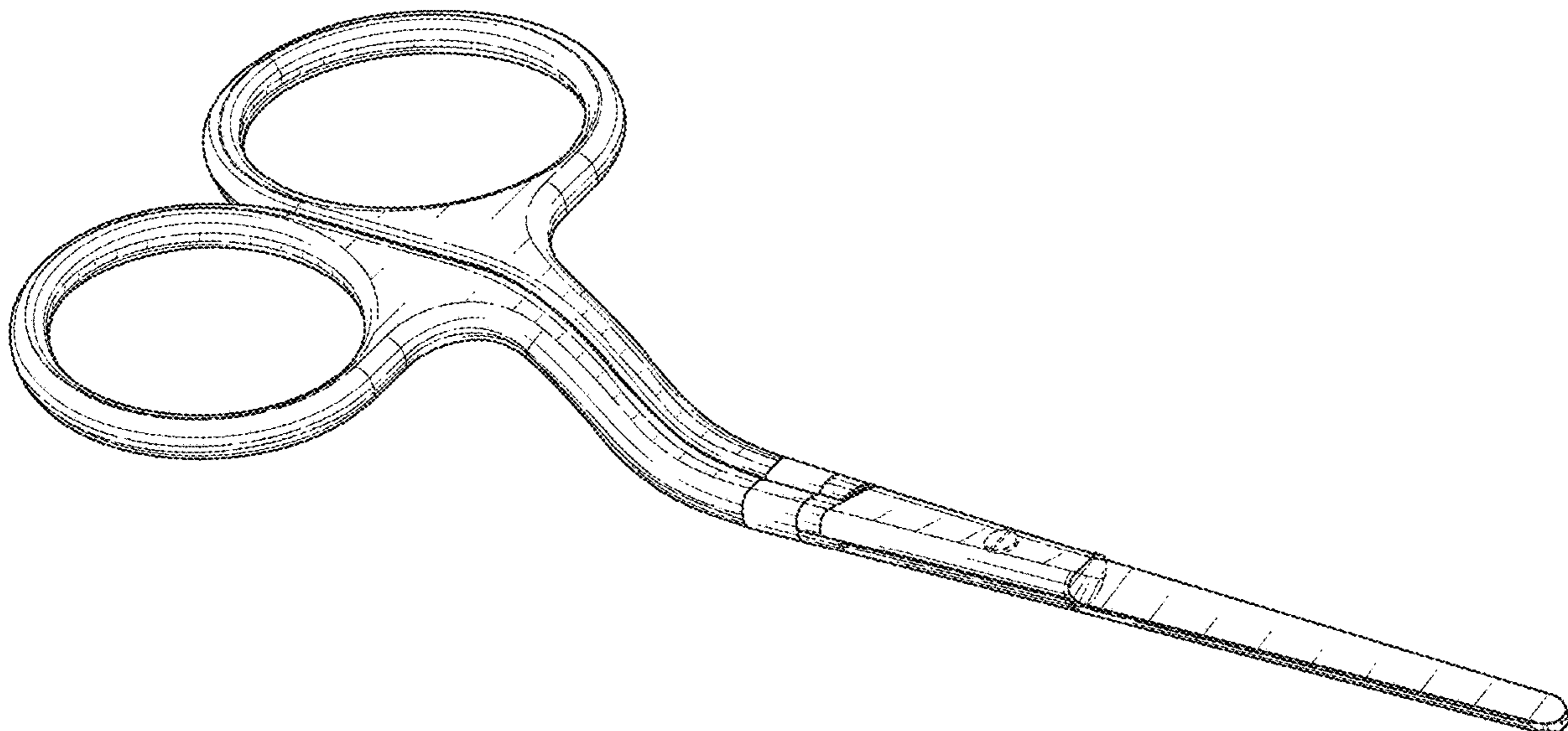

(56)

References Cited

U.S. PATENT DOCUMENTS

D928,321 S	8/2021	Kingsley	
D955,837 S *	6/2022	Poppek	D8/57
2003/0229371 A1	12/2003	Whitworth	
2015/0306776 A1 *	10/2015	Schmithorst	B26B 13/12 30/252
2018/0272547 A1	9/2018	Poppek	

* cited by examiner

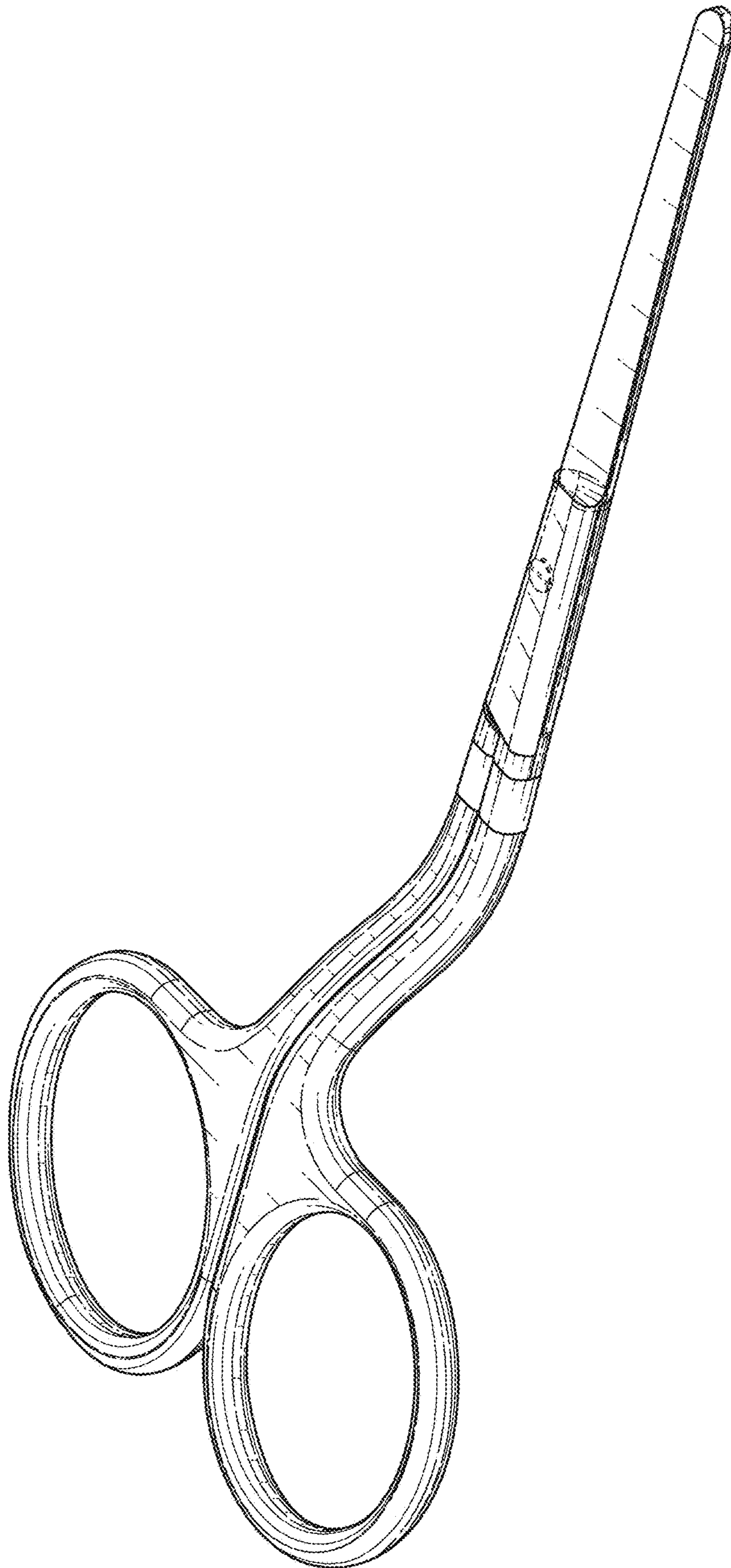

FIG. 1

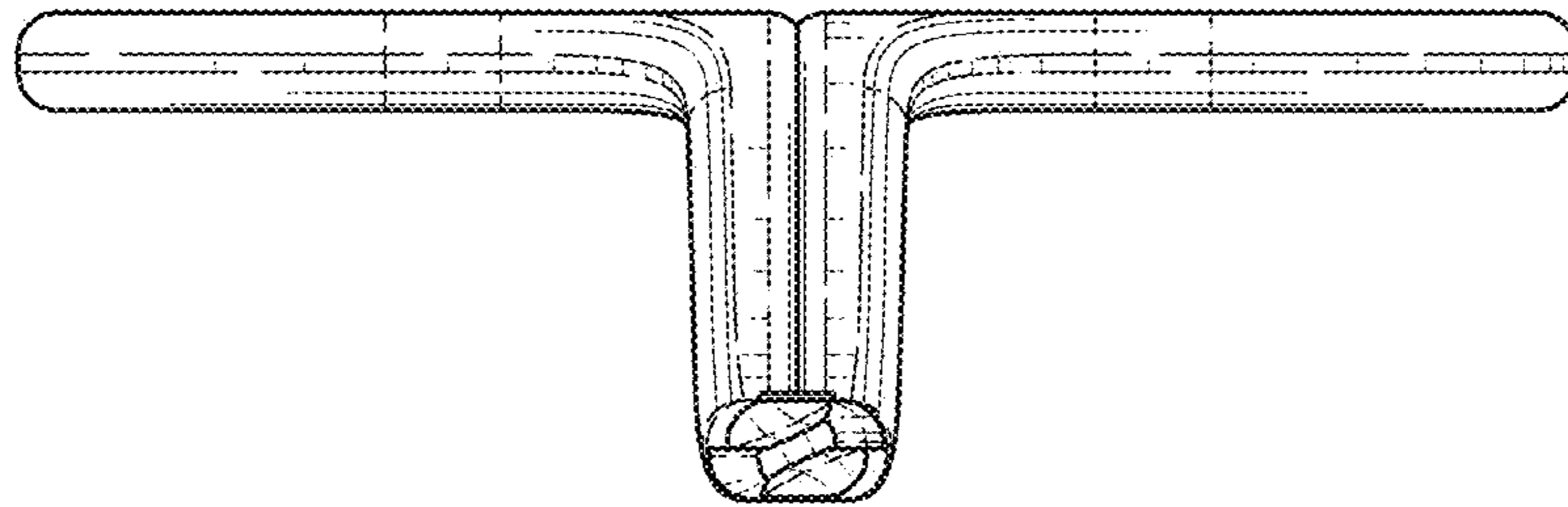

FIG. 2

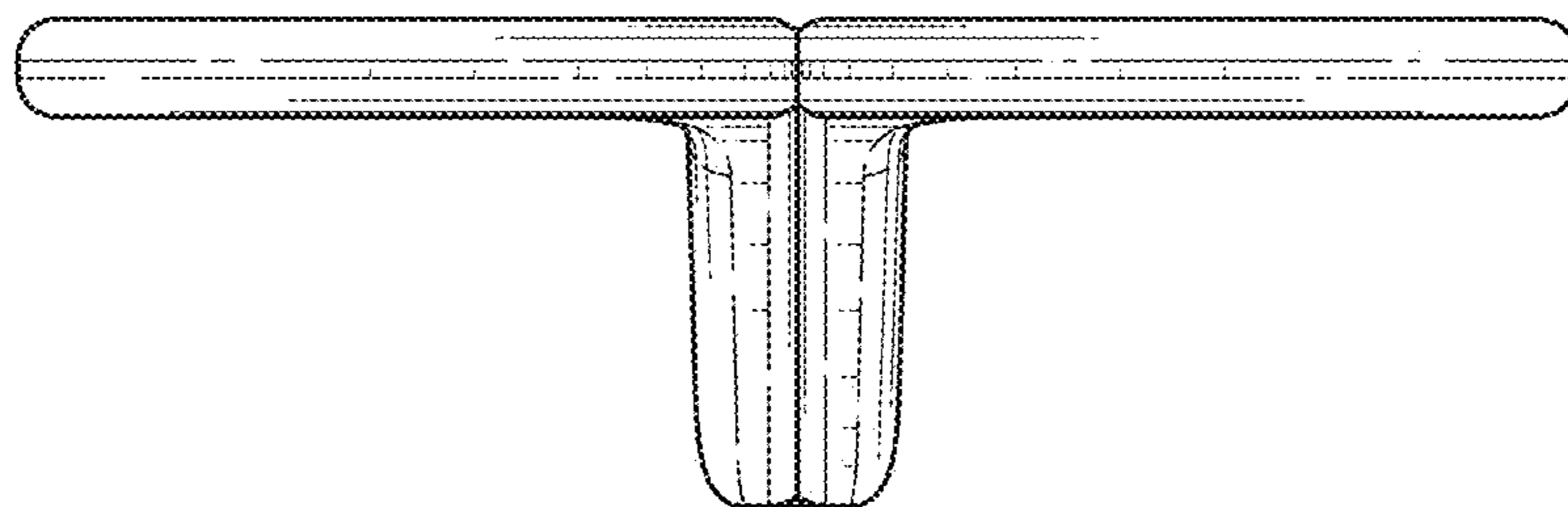

FIG. 3

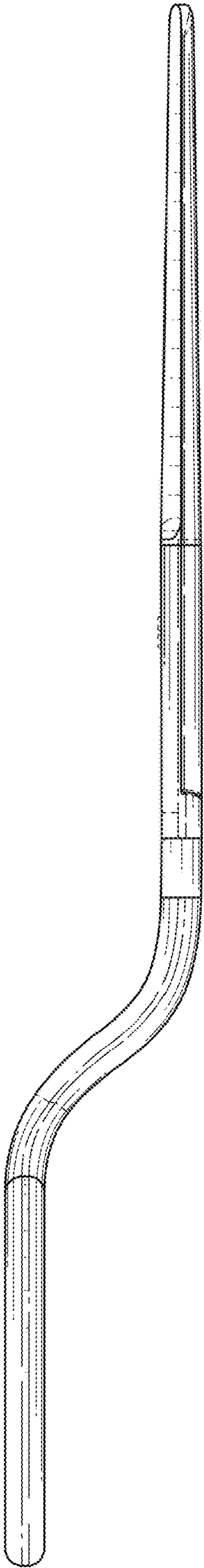

FIG. 4

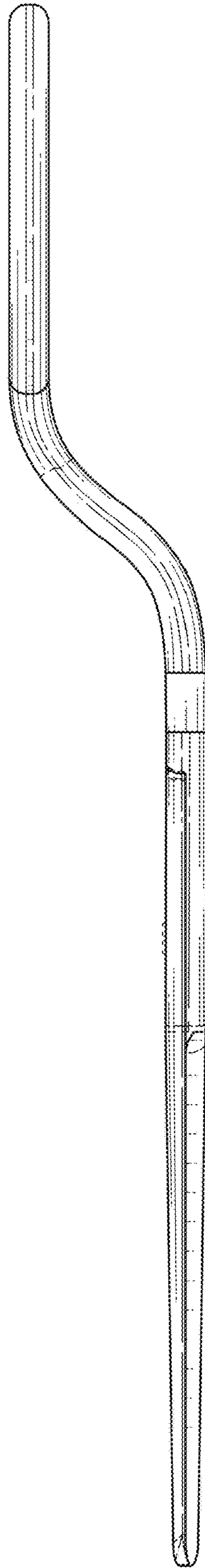

FIG. 5

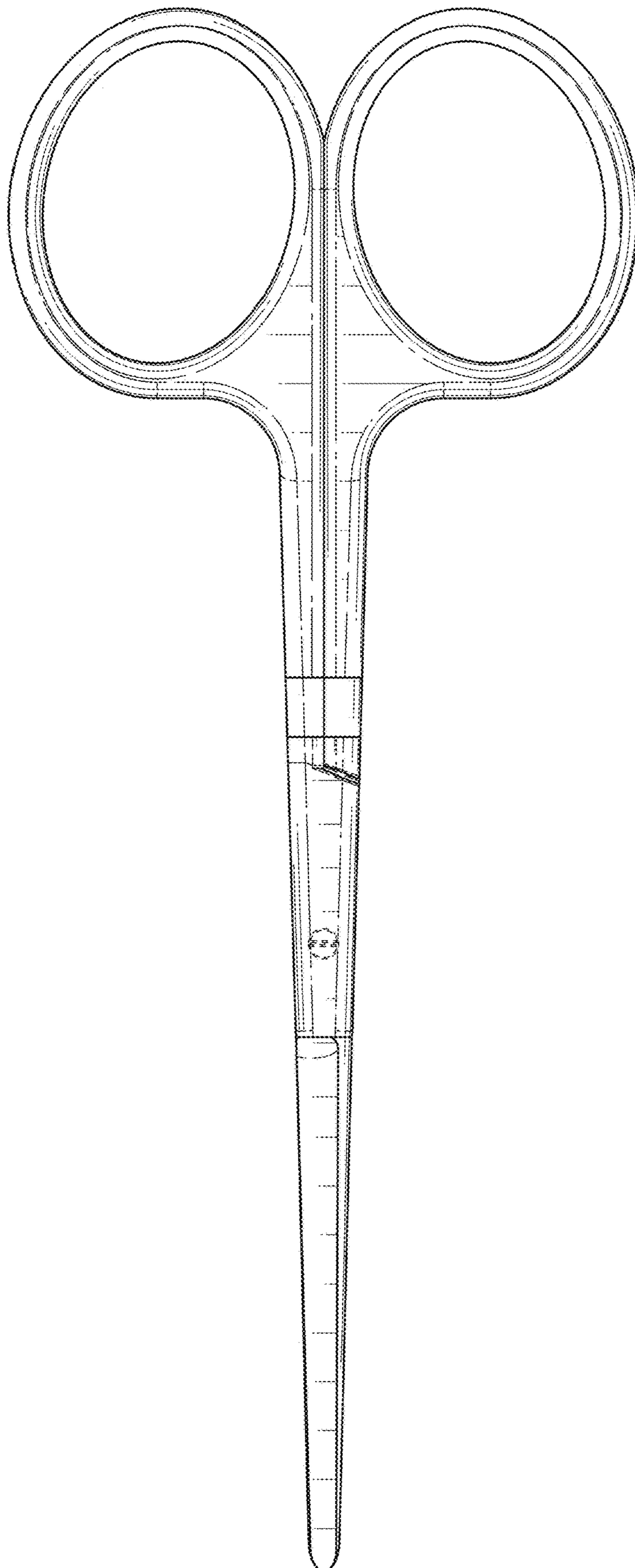

FIG. 6

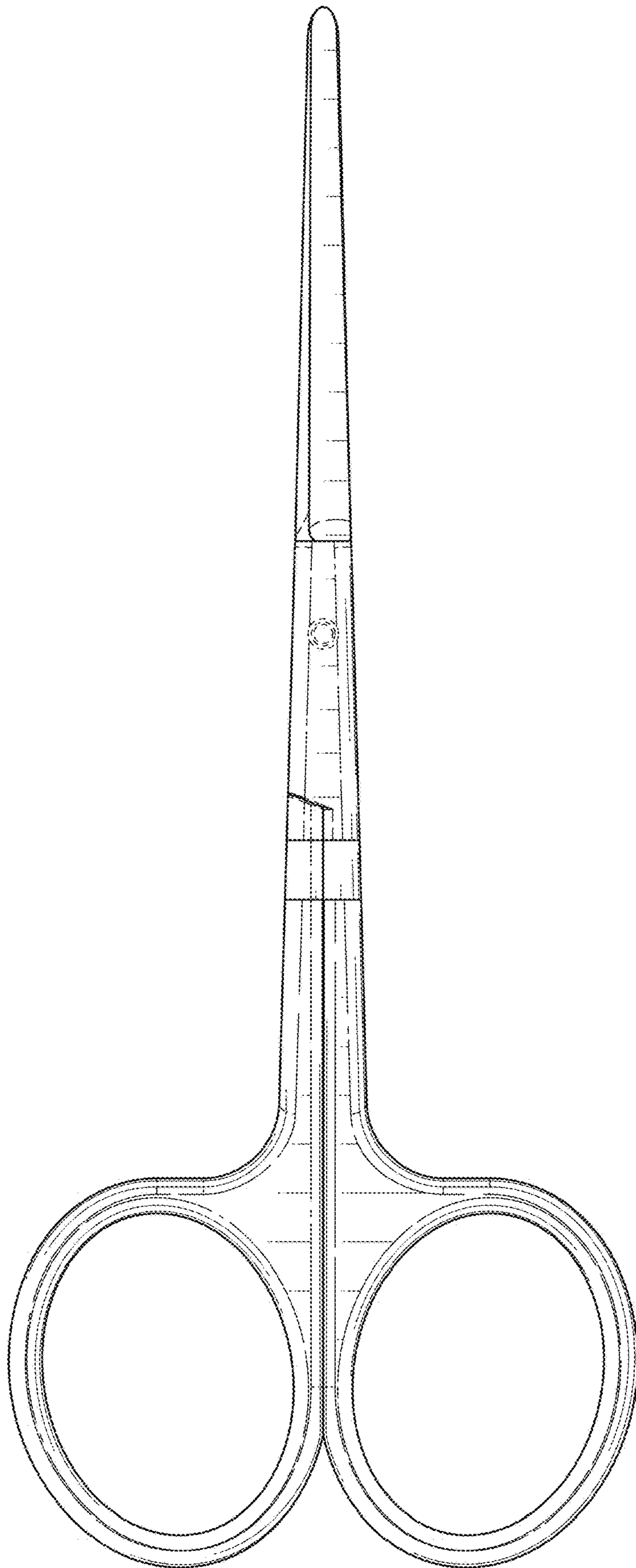

FIG. 7

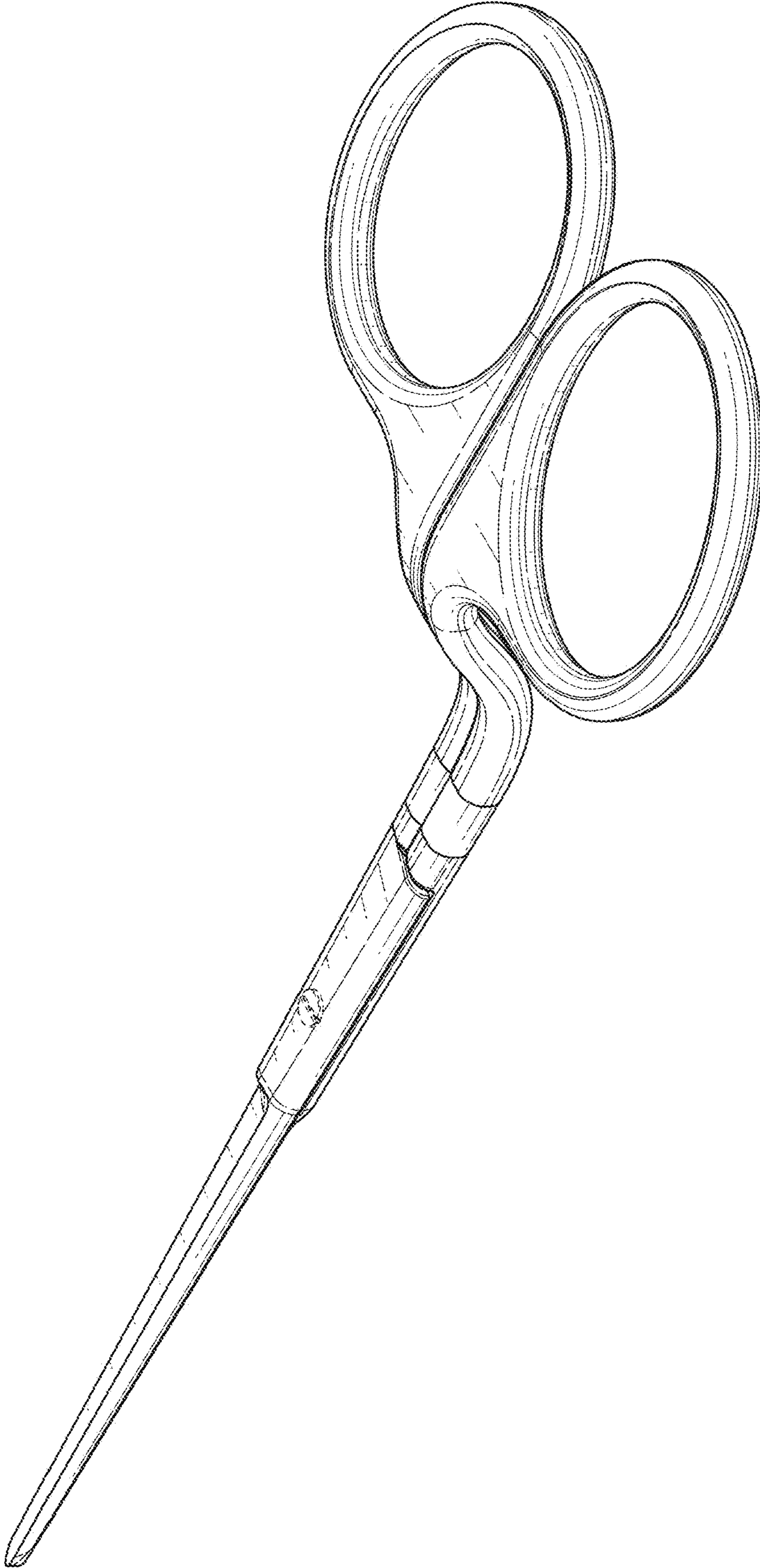

FIG. 8

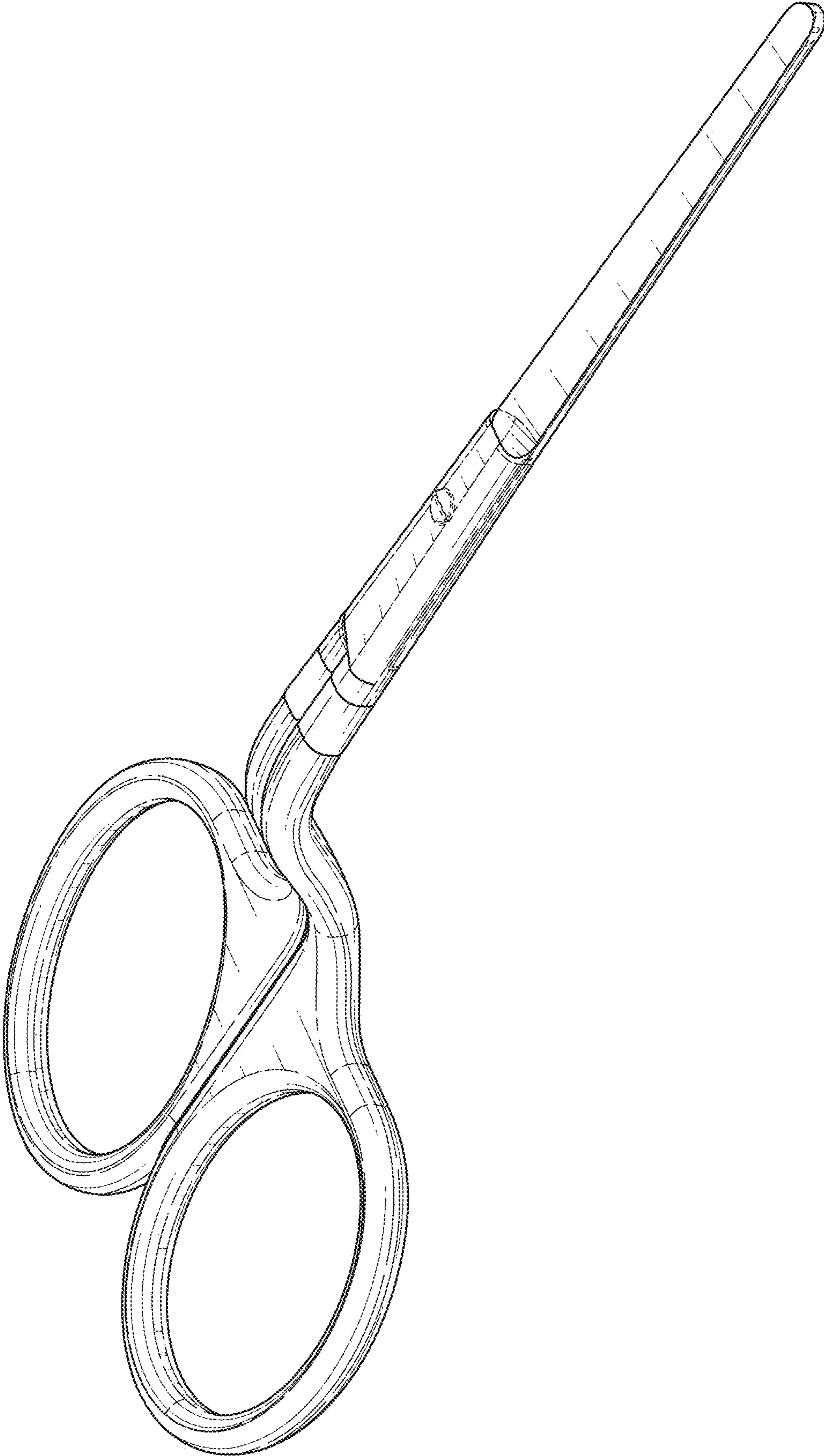

FIG. 9

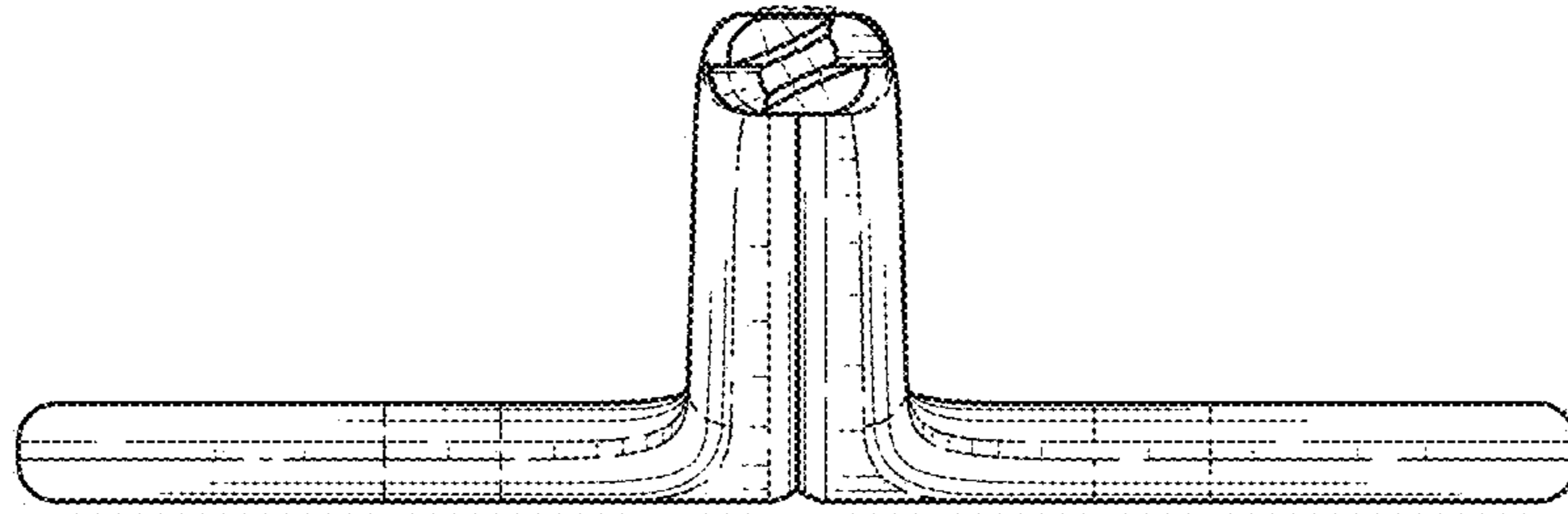

FIG. 10

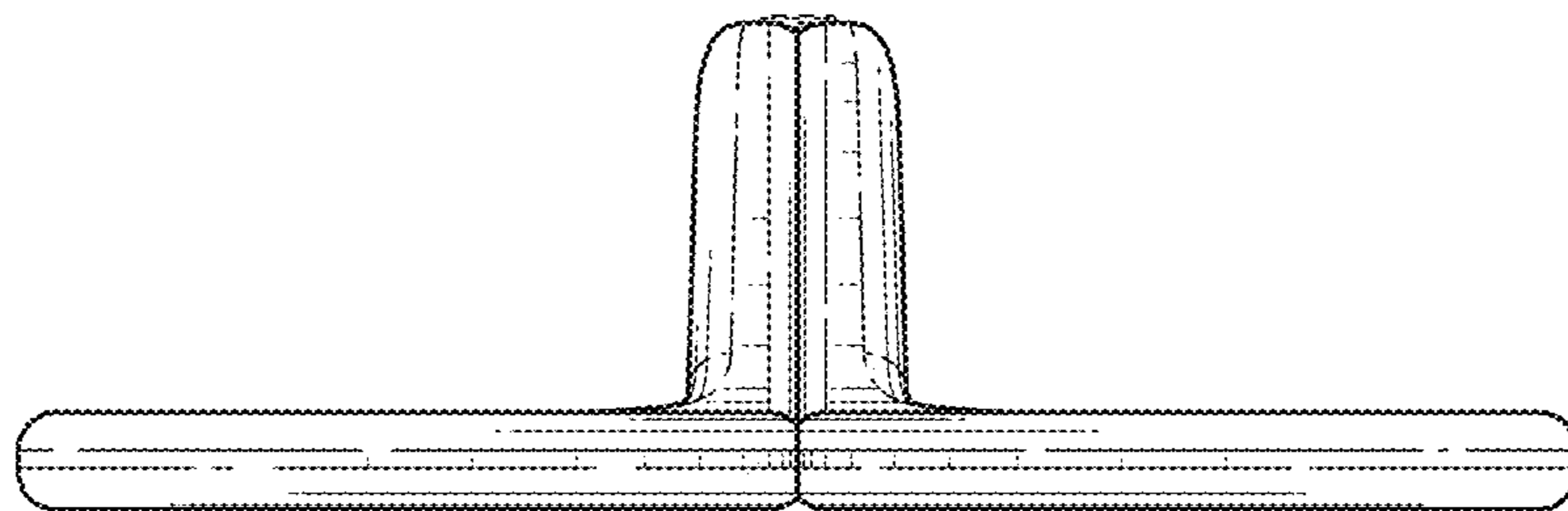

FIG. 11

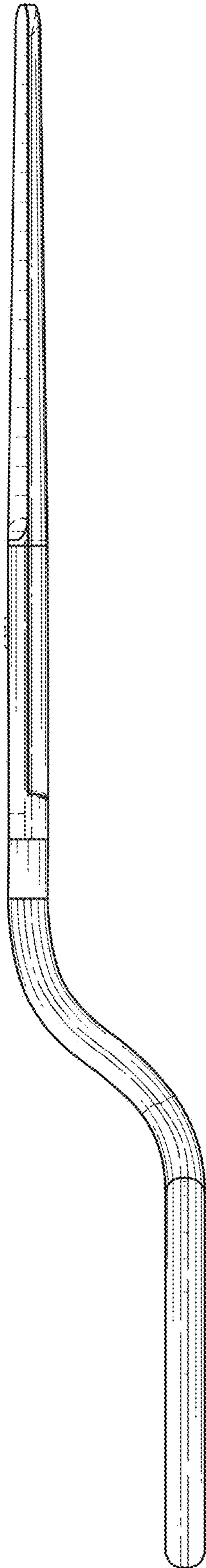

FIG. 12

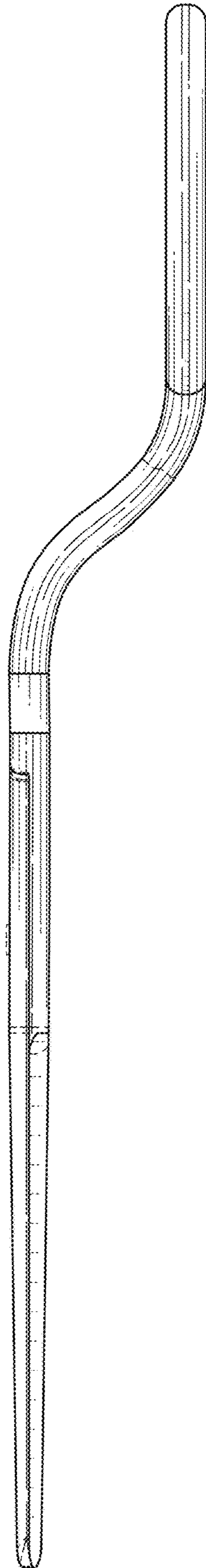

FIG. 13

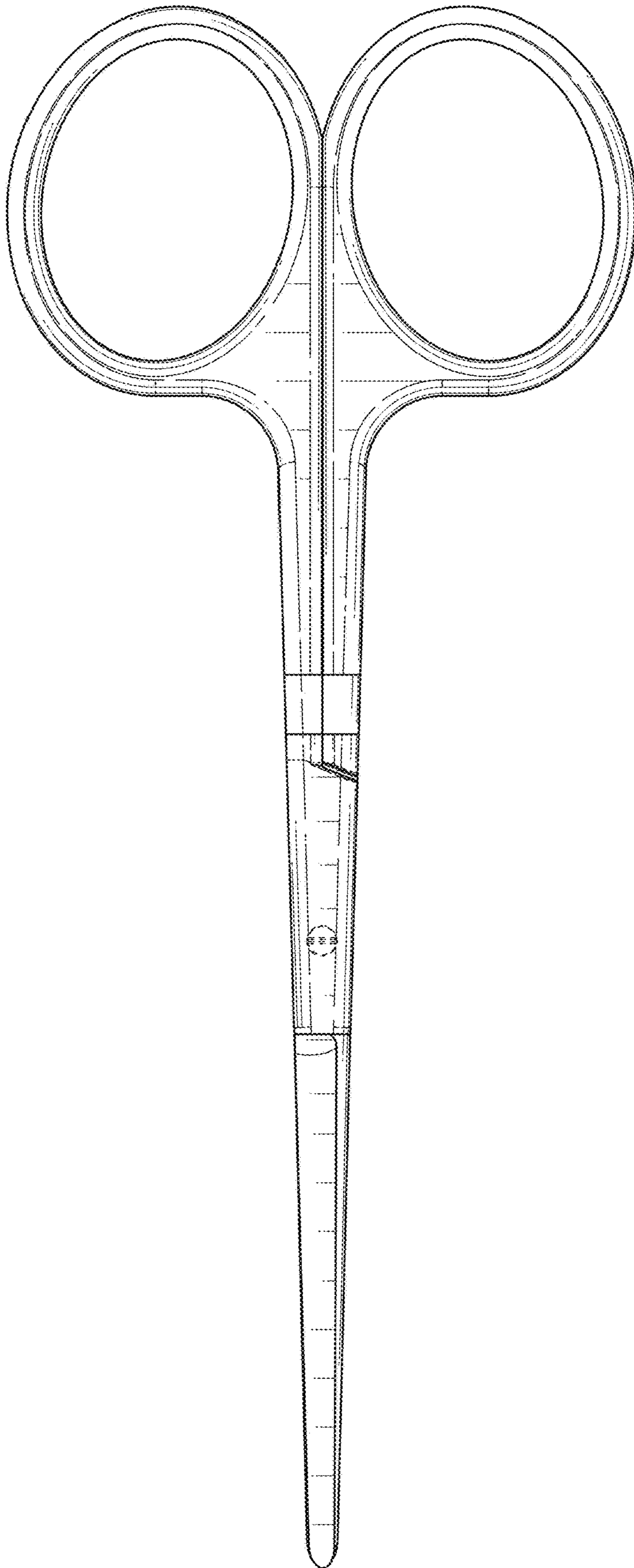

FIG. 14

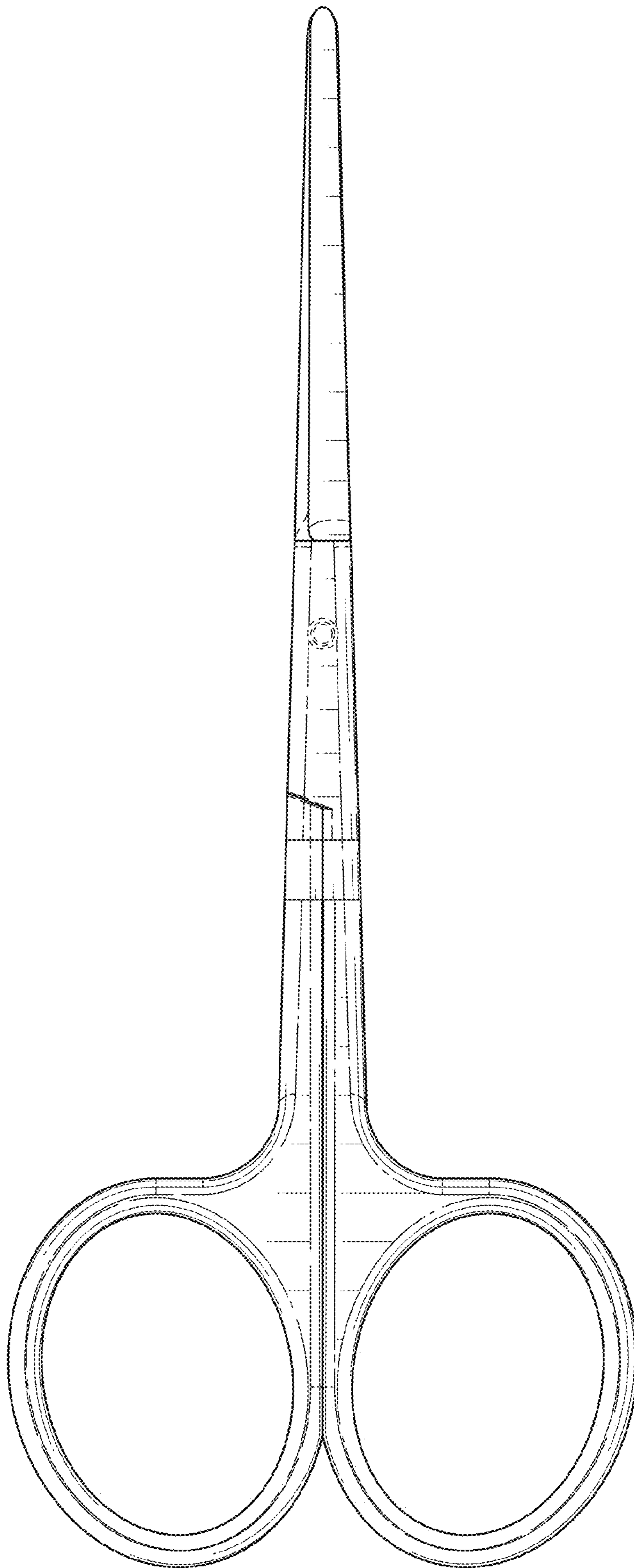

FIG. 15



FIG. 16