



US00D979354S

(12) **United States Design Patent**
Deutsch

(10) **Patent No.:** **US D979,354 S**

(45) **Date of Patent:** **** Feb. 28, 2023**

(54) **LIQUOR DECANTER BASE**

(71) Applicant: **Rachel Deutsch**, Brooklyn, NY (US)

(72) Inventor: **Rachel Deutsch**, Brooklyn, NY (US)

(**) Term: **15 Years**

(21) Appl. No.: **29/774,236**

(22) Filed: **Mar. 15, 2021**

(51) **LOC (14) Cl.** **07-01**

(52) **U.S. Cl.**
USPC **D7/702; D7/389; D7/551.1**

(58) **Field of Classification Search**

USPC D2/617; D7/301, 311, 342, 345, 389,
D7/506, 514, 518, 520, 521, 539, 544,
D7/551.1, 553.5, 553.6, 556, 559, 563,
D7/564, 566, 567, 571, 576, 577, 582,
D7/583, 593, 594, 599, 604, 606, 613,
D7/619.2, 623, 625, 628, 634, 636, 639,
D7/651, 654, 659, 660, 661, 675, 684,
D7/689, 699, 702, 710; D9/544, 614,
D9/624; D11/99, 149, 157, 160, 172;
D19/6, 8, 24, 28, 30, 31, 33, 34.3, 34.5,
(Continued)

(56) **References Cited**

U.S. PATENT DOCUMENTS

1,340,974 A 5/1920 O'Reilly
D129,527 S 9/1941 Hannigan
(Continued)

FOREIGN PATENT DOCUMENTS

CN 302882868 * 7/2014
GB 4004045 * 9/2007

OTHER PUBLICATIONS

Craft It Easy!, "5" Set of Rifle M16 AR15 Gun Unfinished Laser
Cut Wood A019, Aug. 21, 2020, Amazon.com, www.amazon.com/

Rifle-AR15-Unfinished-Laser-Thickness/dp/B08GGCBRP4 (Year:
2020).*

(Continued)

Primary Examiner — Joseph Kukella
Assistant Examiner — Arva P Adams
(74) *Attorney, Agent, or Firm* — Quickpatents, LLC;
Kevin Prince

(57) **CLAIM**

The ornamental design for a liquor decanter base, as shown
and described.

DESCRIPTION

FIG. 1 is a top, front perspective view of a first embodiment
of a liquor decanter base, showing my new design;
FIG. 2 is a top plan view of FIG. 1;
FIG. 3 is a bottom plan view of FIG. 1;
FIG. 4 is a left-side elevational view of FIG. 1;
FIG. 5 is a right-side elevational view of FIG. 1;
FIG. 6 is a front elevational view of FIG. 1;
FIG. 7 is a rear elevational view of FIG. 1;
FIG. 8 is a top, front perspective view of a second embodi-
ment of a liquor decanter base, showing my new design;
FIG. 9 is a top plan view of FIG. 8;
FIG. 10 is a bottom plan view of FIG. 8;
FIG. 11 is a left-side elevational view of FIG. 8;
FIG. 12 is a right-side elevational view of FIG. 8;
FIG. 13 is a front elevational view of FIG. 8; and,
FIG. 14 is a rear elevational view of FIG. 8.

The broken lines in FIGS. 1 and 8 depicting glasses and a
rifle-shaped decanter depict environmental subject matter
that forms no part of the claimed design. The remaining
broken lines depict portions of the liquor decanter base that
form no part of the claimed design. The dot-dash broken
lines show a boundary of the claimed design, and form no
part of the claimed design.

1 Claim, 8 Drawing Sheets

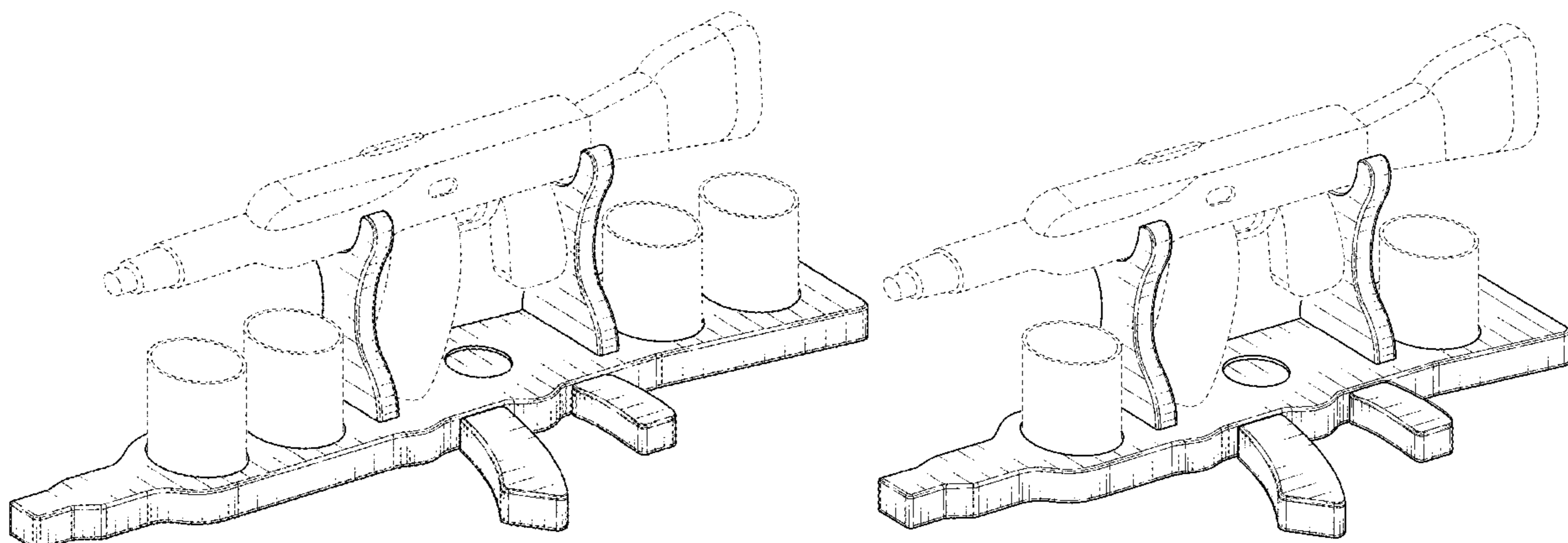

(58) **Field of Classification Search**

USPC D19/82, 94, 137, 140, 144, 151; D20/3, D20/23, 25, 32, 33; D26/4, 7, 14, 16, D26/17-19, 32, 33, 47, 57, 94, 98, 99, D26/101, 125-127, 146, 147, 156; D27/106, 114, 119, 148, 151, 165, 171, D27/177, 178, 182, 188, 192; D10/6, 8, D10/33, 35, 54, 106.4; D29/123; D8/38, D8/53, 305, 351, 365
 CPC A47G 23/02; A47G 23/0208; A47G 23/0241; A47G 23/03; A47G 23/0641; A47G 2023/0666; B65D 1/34
 See application file for complete search history.

(56) **References Cited**

U.S. PATENT DOCUMENTS

3,301,424 A 1/1967 Berzac
 D207,408 S 4/1967 Levin
 D299,695 S 2/1989 Hine
 D303,195 S 9/1989 Devine
 D313,886 S 1/1991 Southard
 D375,658 S 11/1996 Reichert
 D387,123 S 12/1997 Hughes
 D410,383 S 6/1999 Tarashchansky
 D505,298 S 5/2005 Holt
 D546,627 S * 7/2007 Price D7/552.1
 D576,849 S * 9/2008 Carfagna D7/550.1
 D596,493 S 7/2009 Florenca
 D613,545 S 4/2010 Pack
 D635,864 S 4/2011 Lee
 D665,227 S 8/2012 Cason
 D673,015 S 12/2012 Durnell
 D688,101 S 8/2013 Angel
 D697,765 S 1/2014 Wampold
 D710,210 S * 8/2014 Tussy D9/680
 D719,783 S 12/2014 Eubank
 D729,117 S * 5/2015 Bishop D11/181
 D740,608 S 10/2015 Apel
 D750,435 S 3/2016 Hebert

D769,675 S * 10/2016 Chavez A63F 13/20
 D799,273 S 10/2017 Wright
 D806,944 S * 1/2018 Elamrani D27/162
 D814,840 S 4/2018 Halioua
 D824,263 S * 7/2018 Hirsch Korn D9/544
 D826,640 S 8/2018 Hirsch Korn
 D851,454 S 6/2019 Lefkowitz
 D857,512 S 8/2019 Vellas
 D871,145 S 12/2019 Hebert
 D871,146 S 12/2019 Herbert
 D873,080 S 1/2020 Eckart
 D874,872 S 2/2020 Godinger
 D881,016 S 4/2020 Hudson
 D881,651 S 4/2020 Hirschkom
 D886,664 S * 6/2020 Kauk D11/172
 D888,571 S 6/2020 Pennington
 D889,893 S * 7/2020 Godinger D7/301
 D889,911 S * 7/2020 Godinger D7/599
 D891,876 S 8/2020 Hoppus
 D896,586 S 9/2020 Wolfgram
 D897,751 S 10/2020 Wolfgram
 D905,514 S * 12/2020 Sanders D7/701
 D908,434 S 1/2021 Murali
 D910,379 S 2/2021 Deutsch
 D917,339 S * 4/2021 Thornburg D11/181
 2008/0087689 A1 4/2008 Mattern
 2018/0236415 A1 8/2018 Chen
 2020/0086212 A1 * 3/2020 Wong A63F 13/20

OTHER PUBLICATIONS

Pumpe Consulting, "Whiskey Gun Decanter Set," Dec. 7, 2020, Amazon.com, www.amazon.com/Whiskey-Decanter-Mahogany-Chilling-Packaging/dp/B08PV6Y5C1 (Year: 2020).
 Pumpe Consulting, "Whiskey Gun Decanter Gift Set," Dec. 7, 2020, Amazon.com, www.amazon.com/Whiskey-Decanter-Mahogany-Chilling-Packaging/dp/B08QDPWQXM (Year: 2020).
 Wayfair, "Red Barrel Studio Emisha Gun 5 Piece Whiskey Decanter Set & Reviews," Feb. 23, 2021, Wayfair, www.wayfair.com/kitchen-tabletop/pdp/red-barrel-studio-emisha-gun-5-piece-whiskey-decanter-set-w000250110.html (Year: 2021).*

* cited by examiner

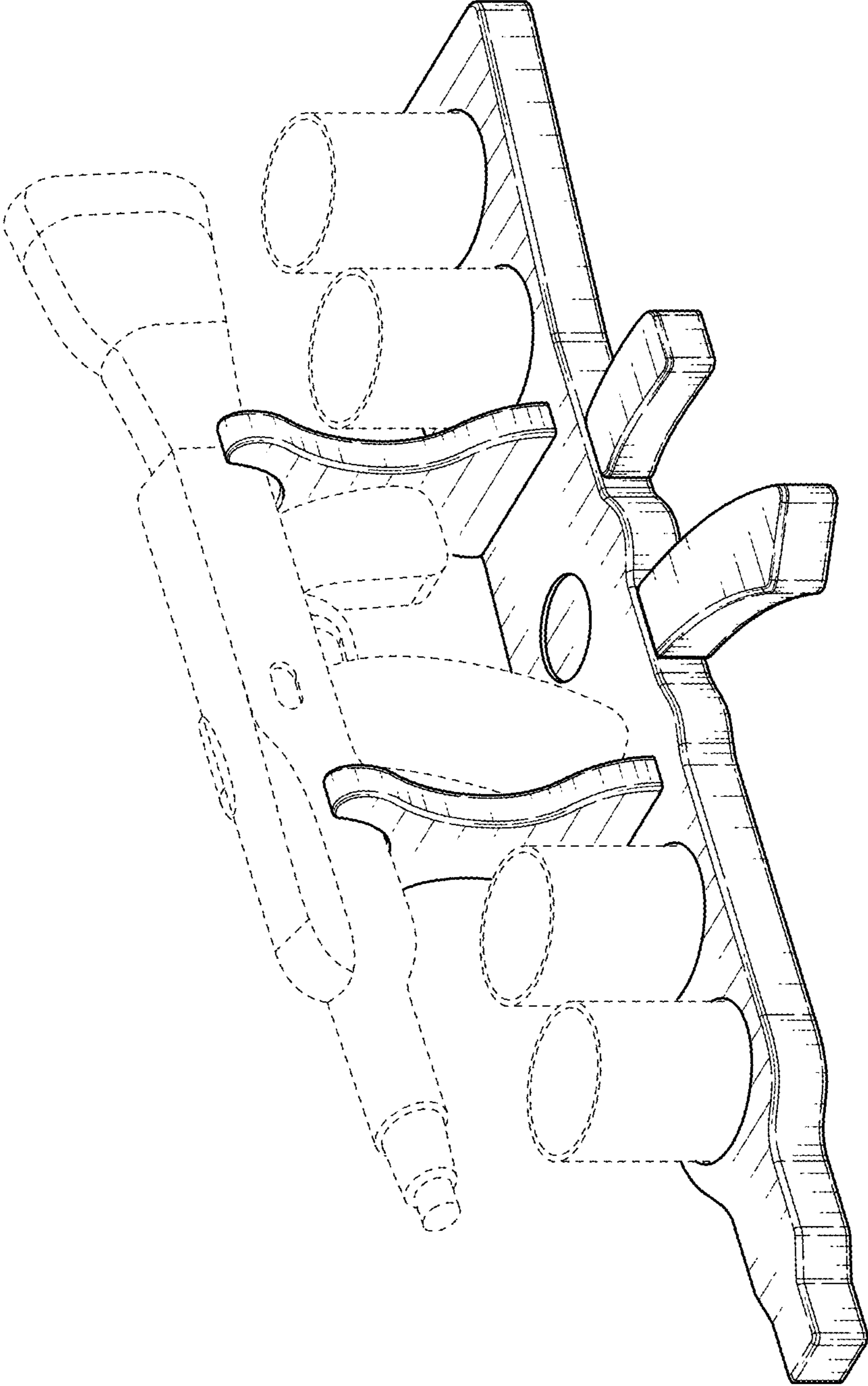

FIG. 1

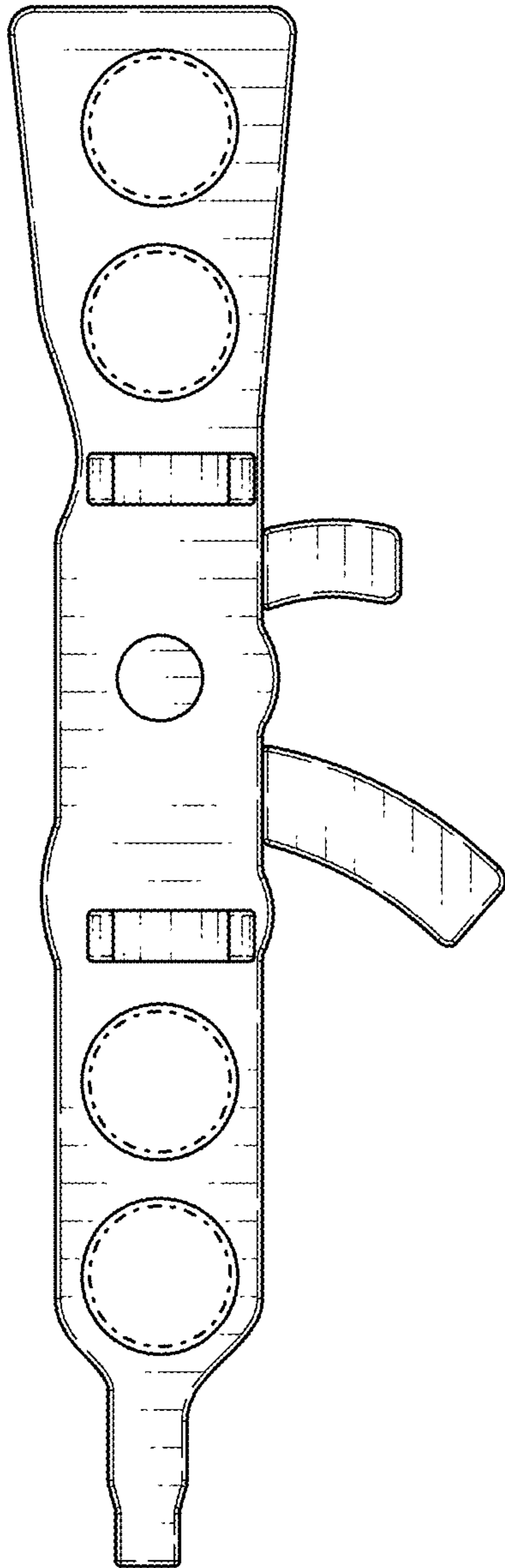

FIG. 2

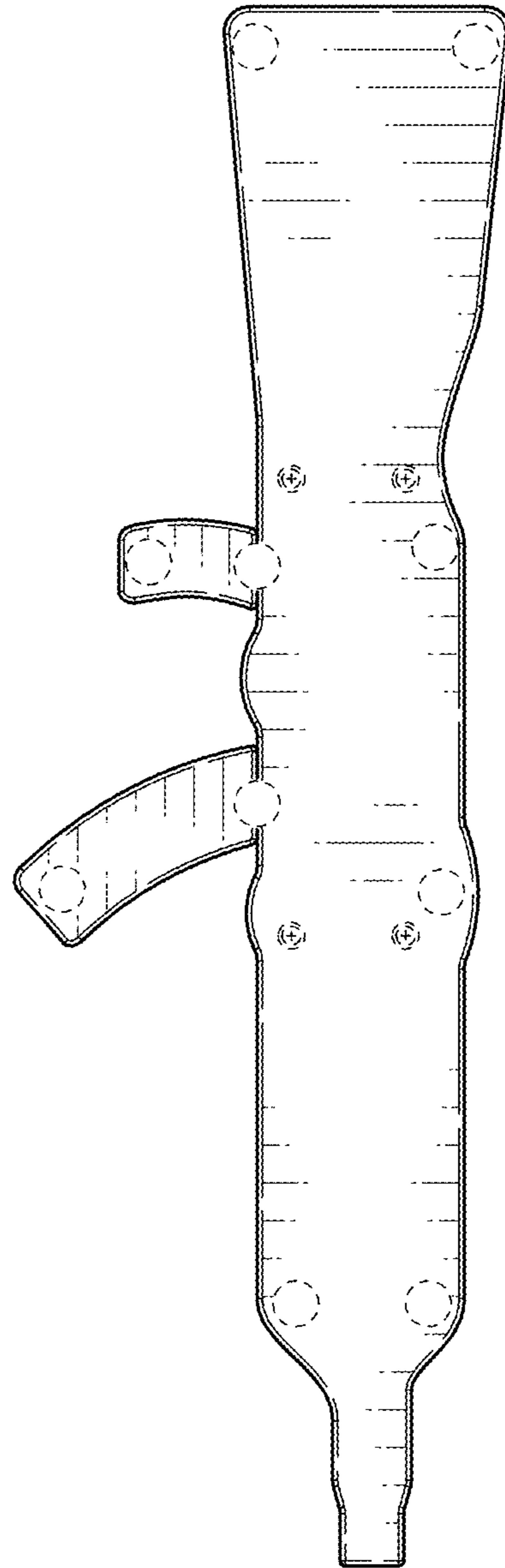

FIG. 3

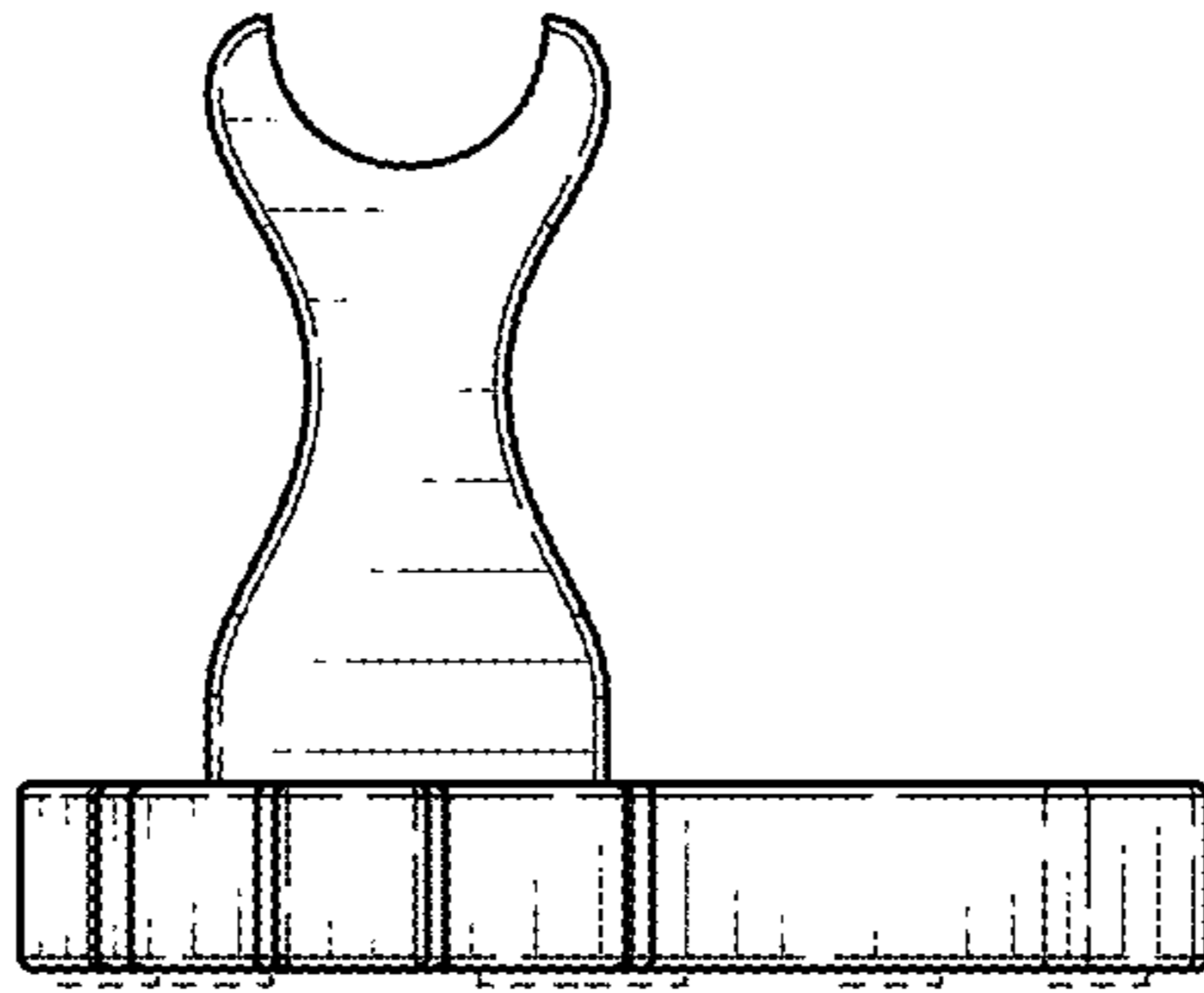

FIG. 4

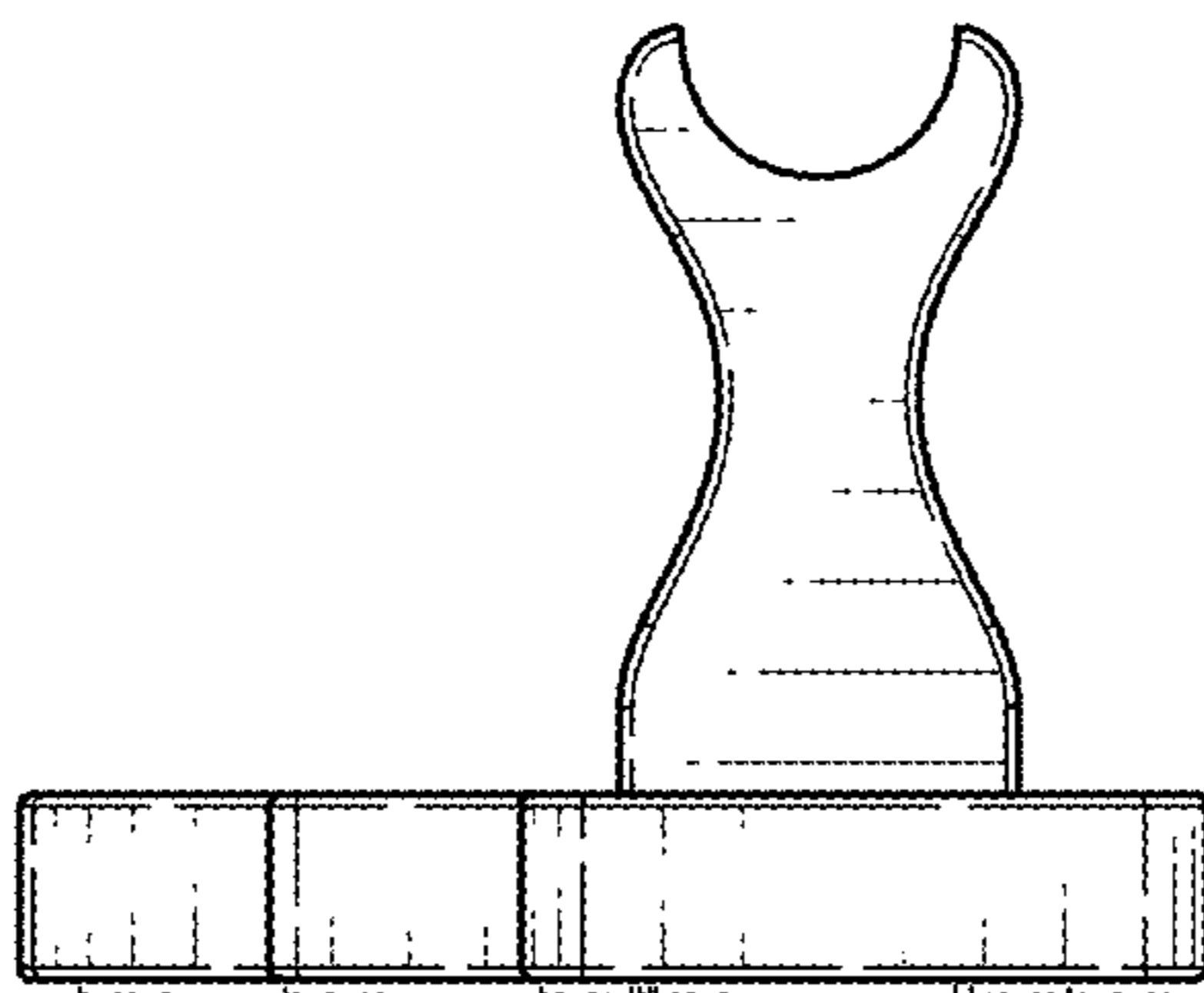

FIG. 5

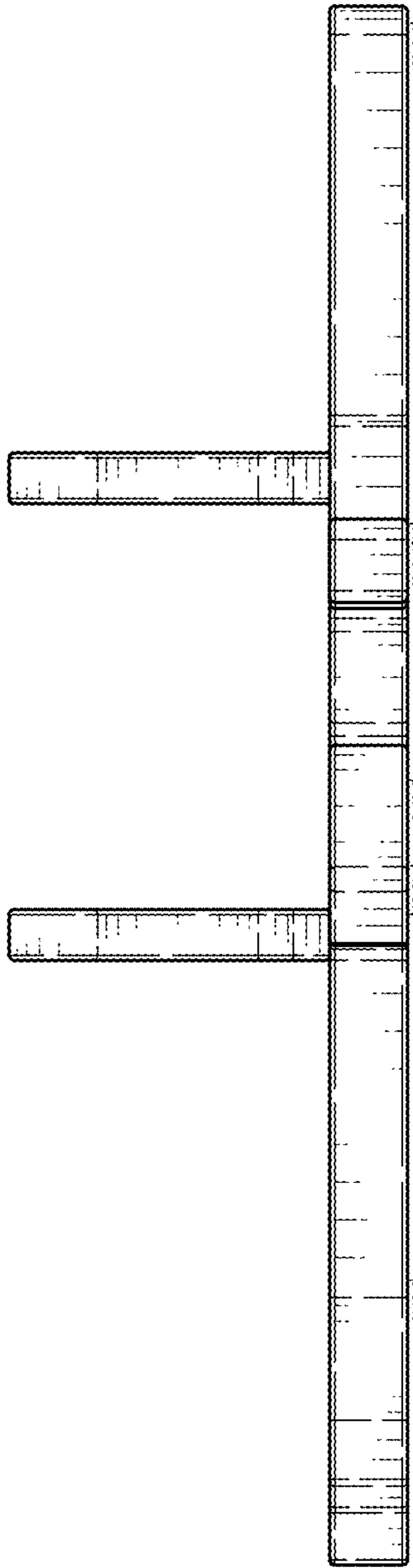

FIG. 6

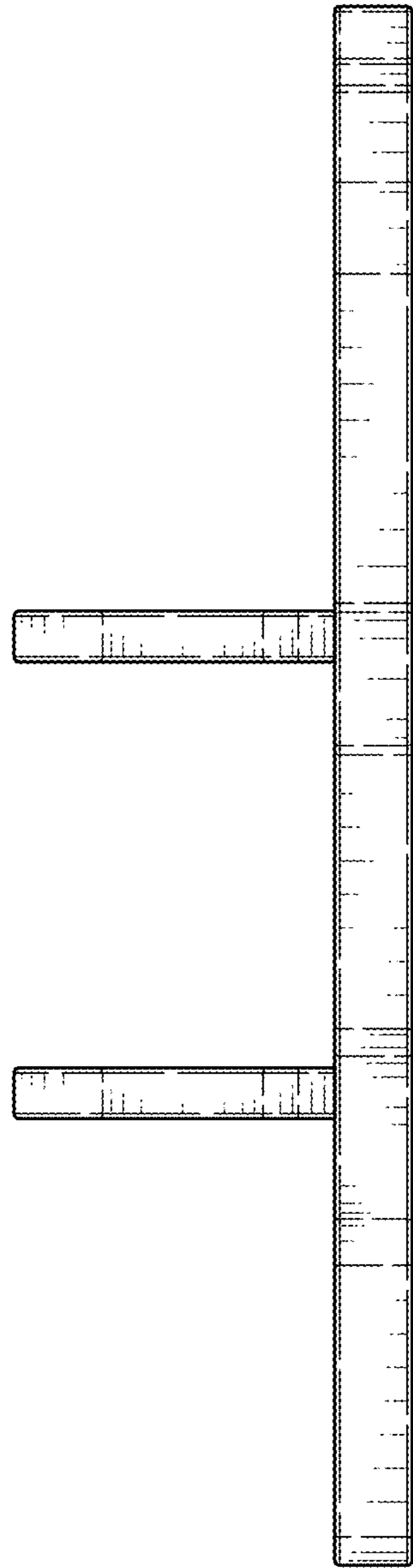

FIG. 7

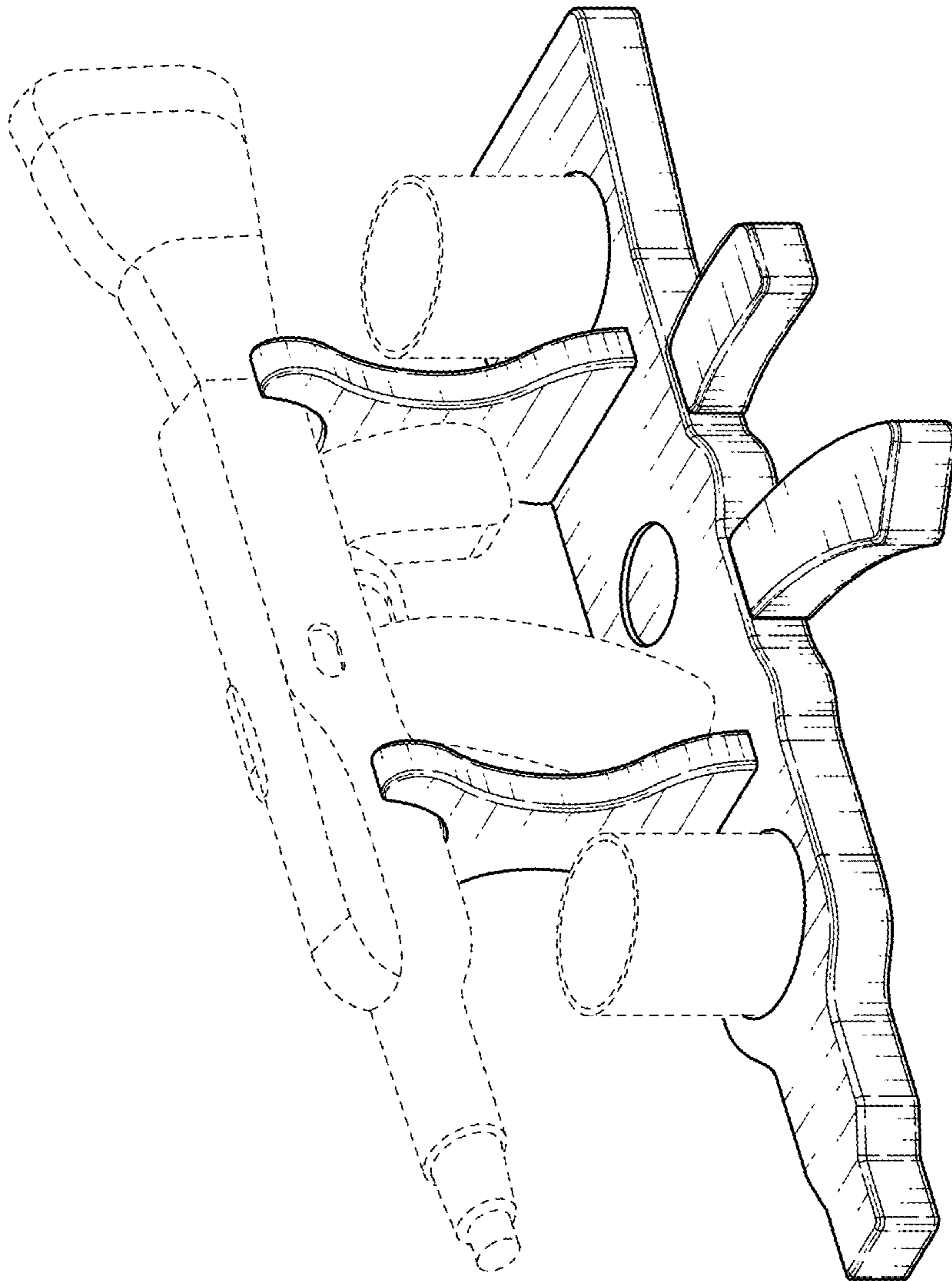

FIG. 8

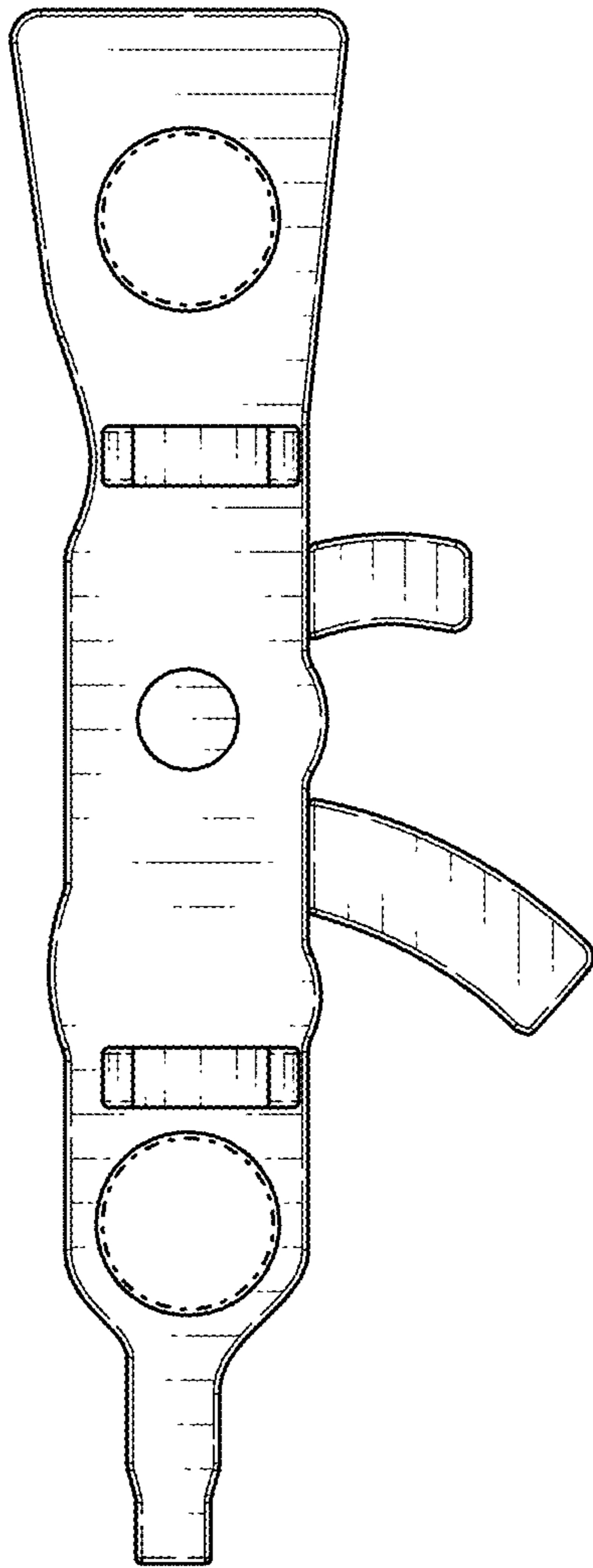

FIG. 9

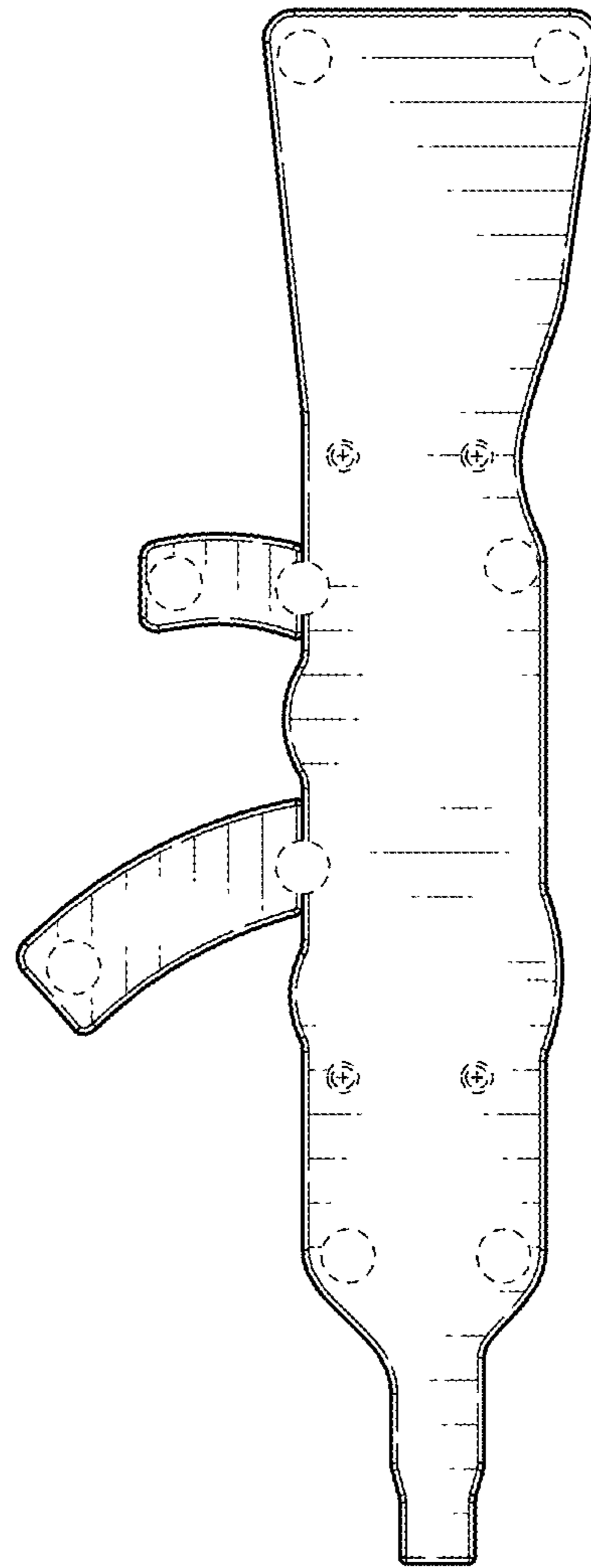

FIG. 10

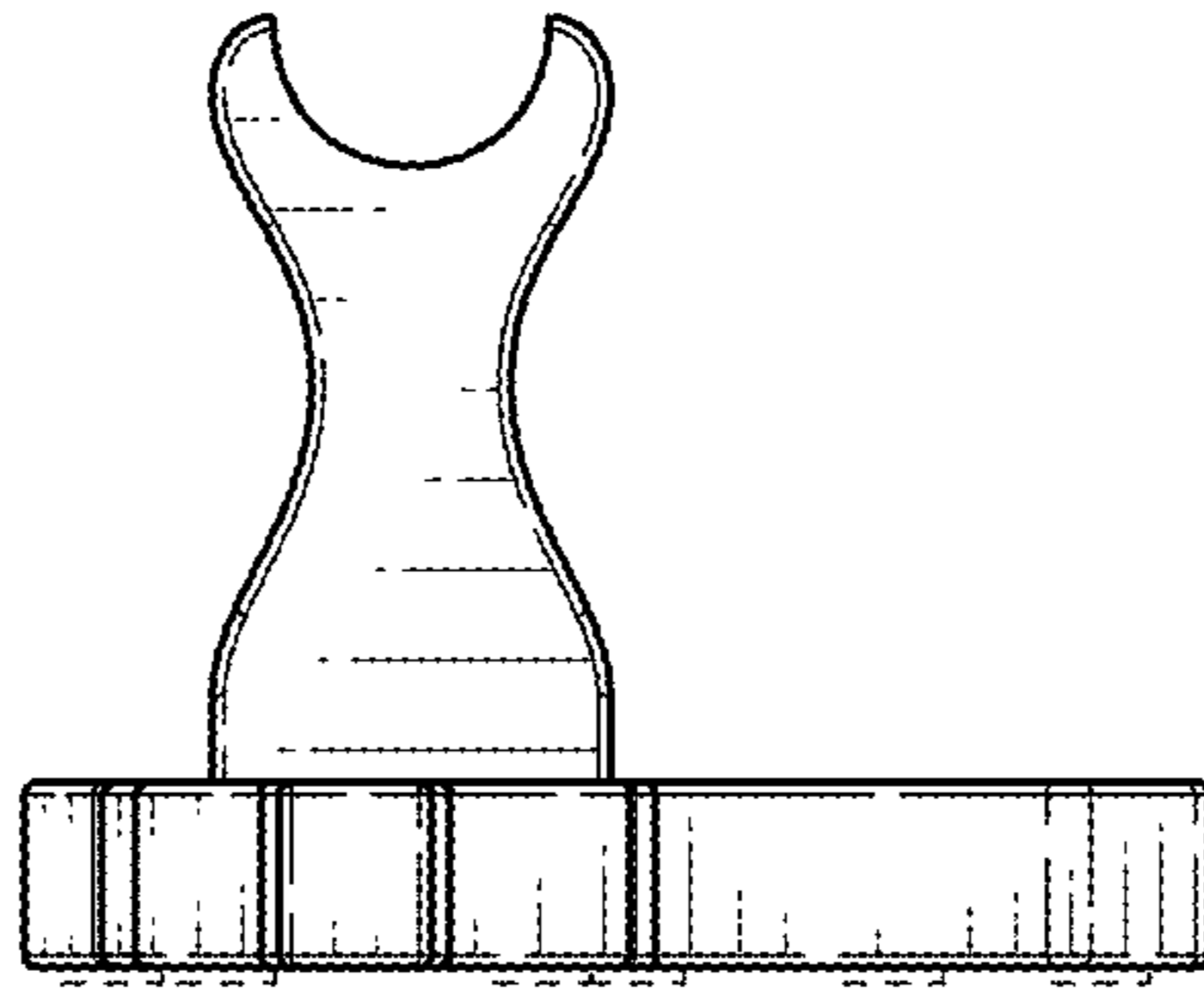

FIG. 11

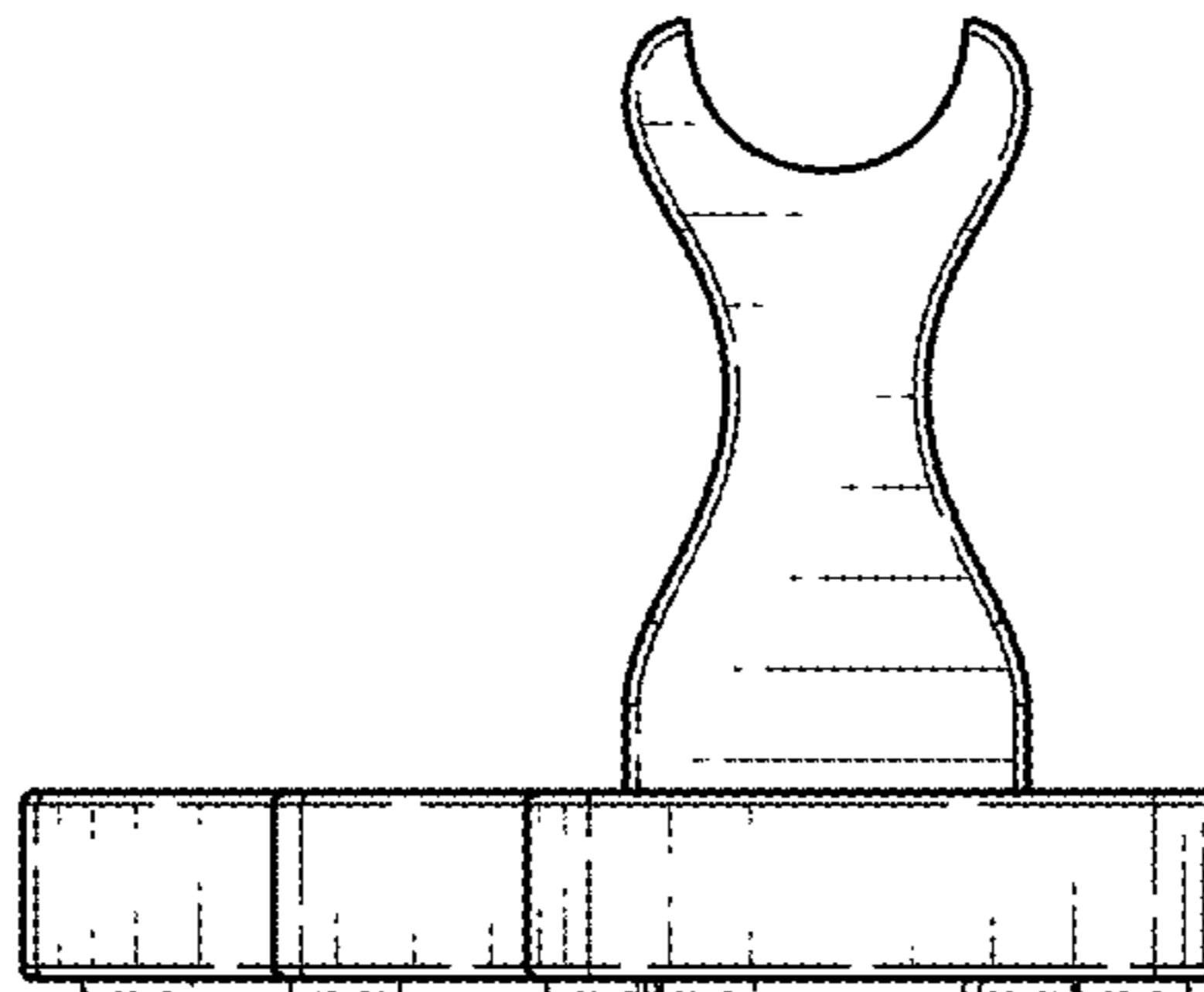

FIG. 12

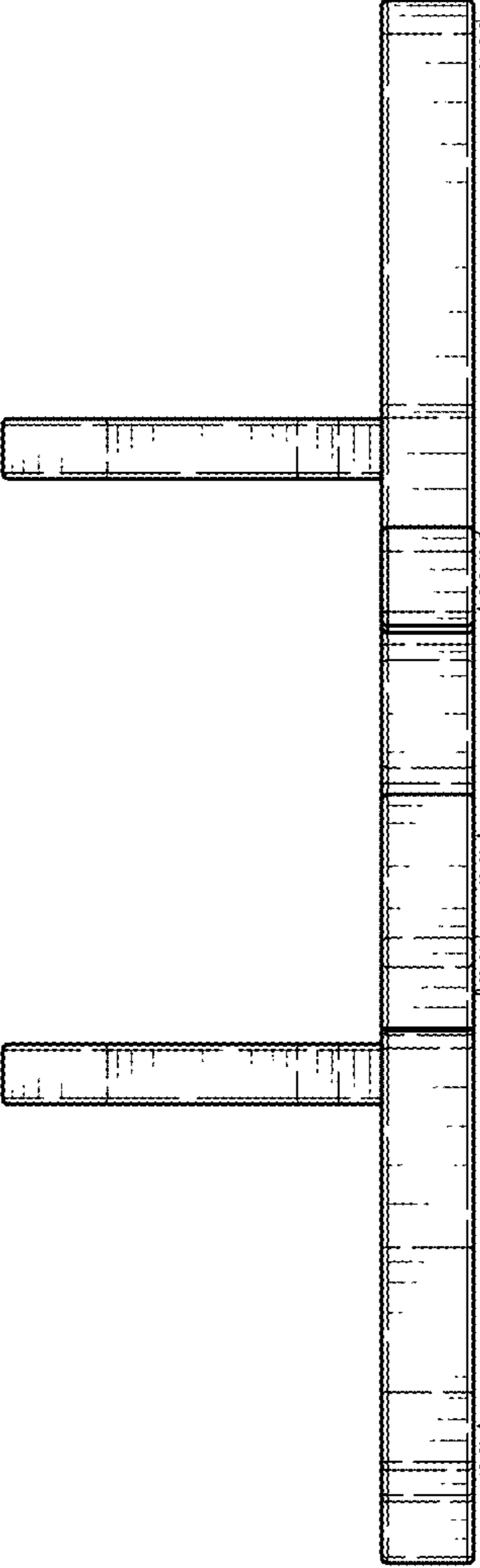

FIG. 13

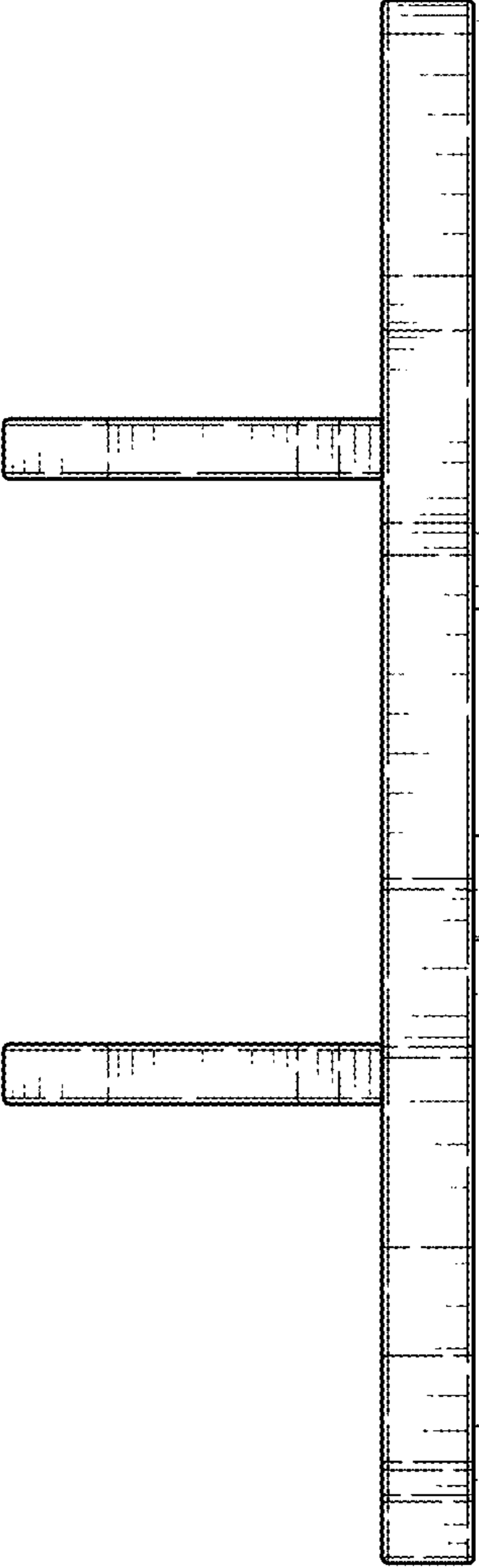

FIG. 14