



US00D979319S

(12) **United States Design Patent**
Porto

(10) **Patent No.:** **US D979,319 S**

(45) **Date of Patent:** **** Feb. 28, 2023**

(54) **MEATLOAF PAN**

(71) Applicant: **Alberto Porto**, San Antonio, TX (US)

(72) Inventor: **Alberto Porto**, San Antonio, TX (US)

(**) Term: **15 Years**

(21) Appl. No.: **29/776,204**

(22) Filed: **Mar. 29, 2021**

(51) **LOC (14) Cl.** **07-02**

(52) **U.S. Cl.**
USPC **D7/359**; D7/354

(58) **Field of Classification Search**

USPC D7/323, 354-361, 542, 543, 545, 549,
D7/550.1, 552.1, 553.1-553.8,
D7/554.1-554.4, 555, 584, 586, 602;
D9/430-433, 455-456, 737, 756-762
CPC A21B 3/00; A21B 3/13; A21B 3/15; A21B
3/134; A21B 5/00; A21B 5/02; A23L
13/50; A47J 36/022; A47J 36/025; A47J
36/027; A47J 36/04; A47J 37/00; A47J
37/04; A47J 37/049; A47J 37/18; A47J
37/106; B65D 1/22; B65D 1/24; B65D
1/34; B65D 1/36; B65D 81/343; B65D
85/36

See application file for complete search history.

(56) **References Cited**

U.S. PATENT DOCUMENTS

3,713,378 A * 1/1973 West A47J 37/106
99/346
3,922,960 A * 12/1975 Lewis A47J 37/106
99/345

4,557,188 A * 12/1985 Spanek A47J 43/18
99/426
4,941,401 A * 7/1990 Sarnoff A47J 36/04
D7/354
5,106,642 A * 4/1992 Ciofalo A23L 13/50
99/421 V
6,487,964 B2 * 12/2002 Snoke A47J 37/049
99/426
D581,208 S * 11/2008 Courington D7/359

* cited by examiner

Primary Examiner — Ricky Pham

(74) *Attorney, Agent, or Firm* — Taboada Law Firm,
PLLC; John M. Taboada

(57) **CLAIM**

The ornamental design of a meatloaf pan, substantially as shown and described.

DESCRIPTION

FIG. 1 is a top view of a meatloaf pan in accordance with the present invention;
FIG. 2 is a left side view of the meatloaf pan of FIG. 1, the right side view being a mirror image of FIG. 2;
FIG. 3 is a front view of the meatloaf pan of FIG. 1;
FIG. 4 is a rear view of the meatloaf pan of FIG. 1; and,
FIG. 5 is a bottom view of the meatloaf pan of FIG. 1.
The broken lines, within the claimed design, depict environmental subject matter only and form no part of the claimed design.

1 Claim, 3 Drawing Sheets

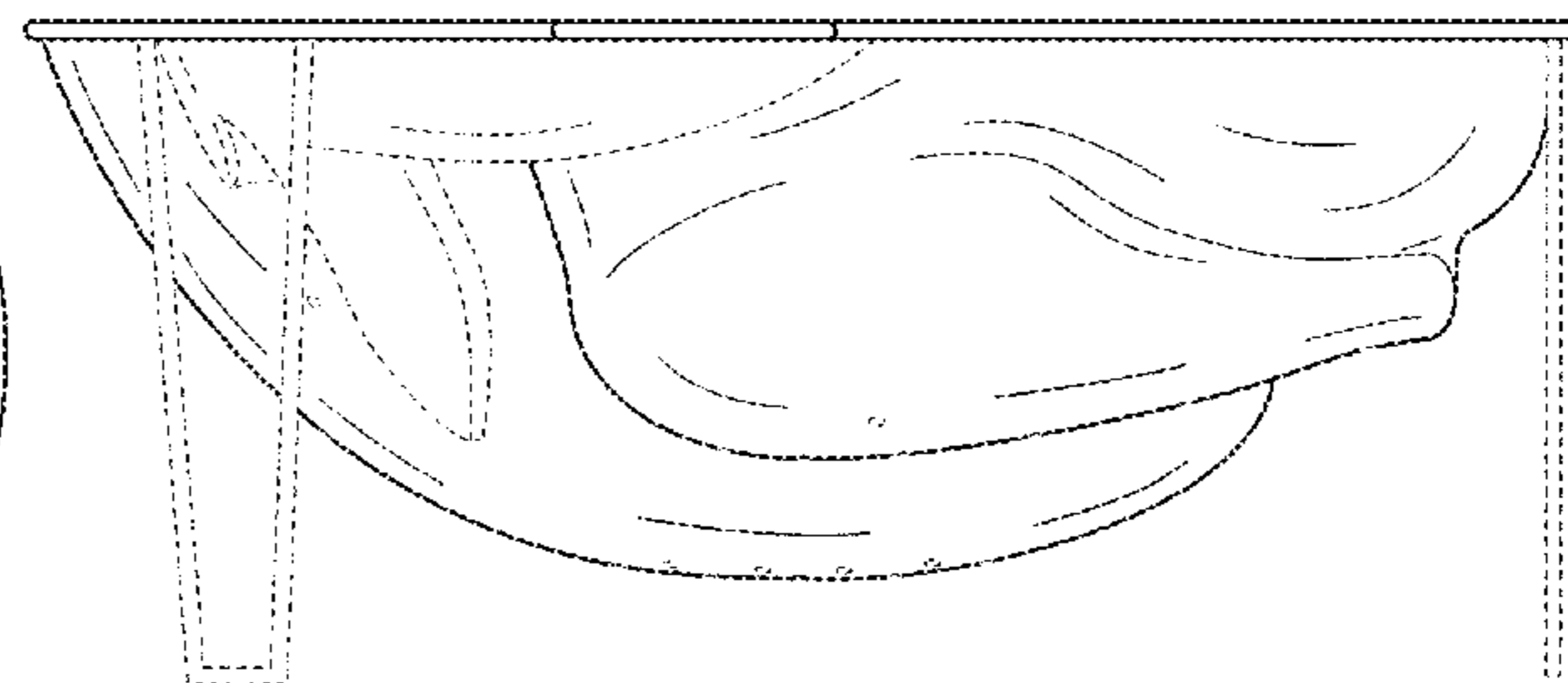
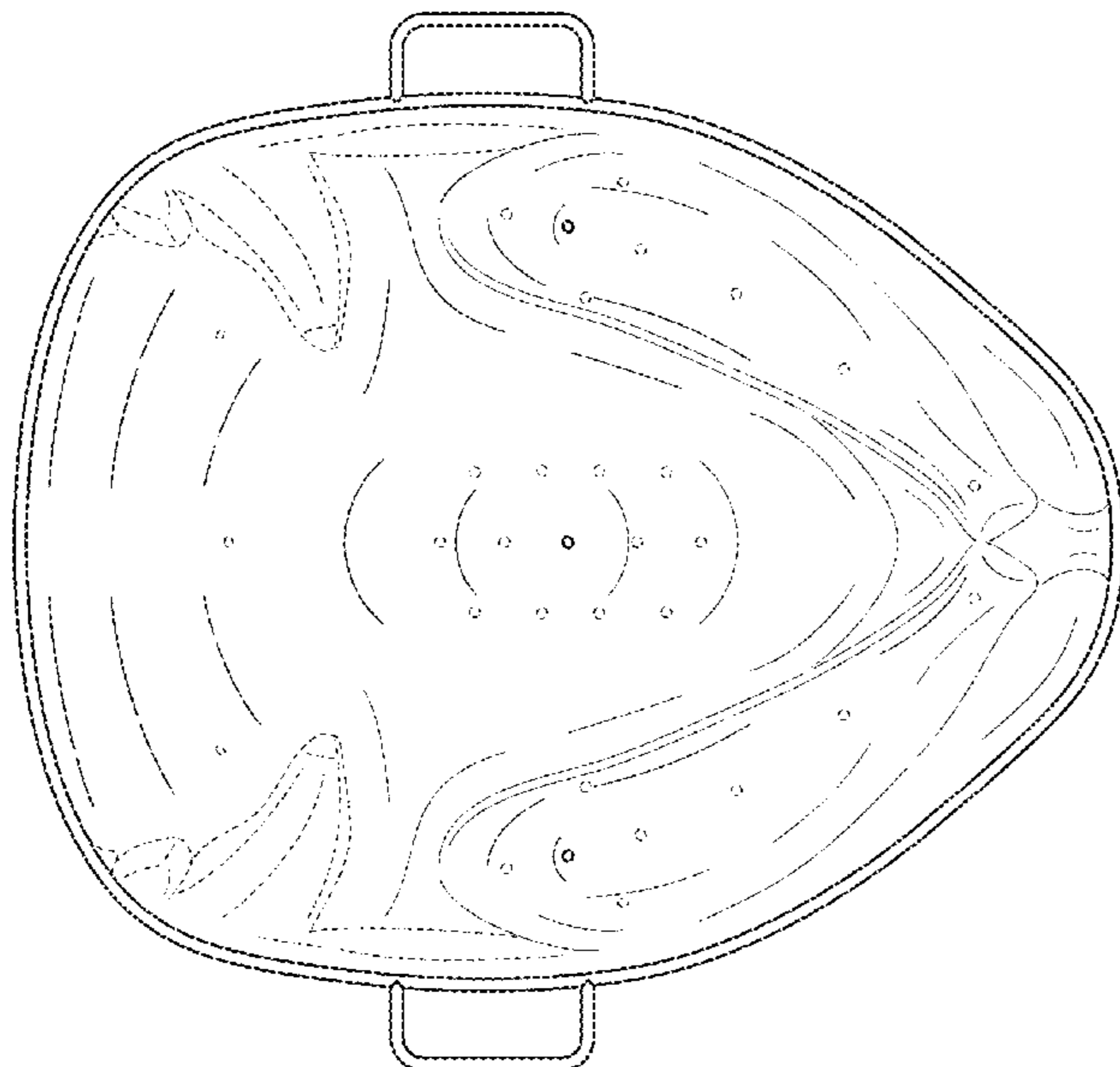

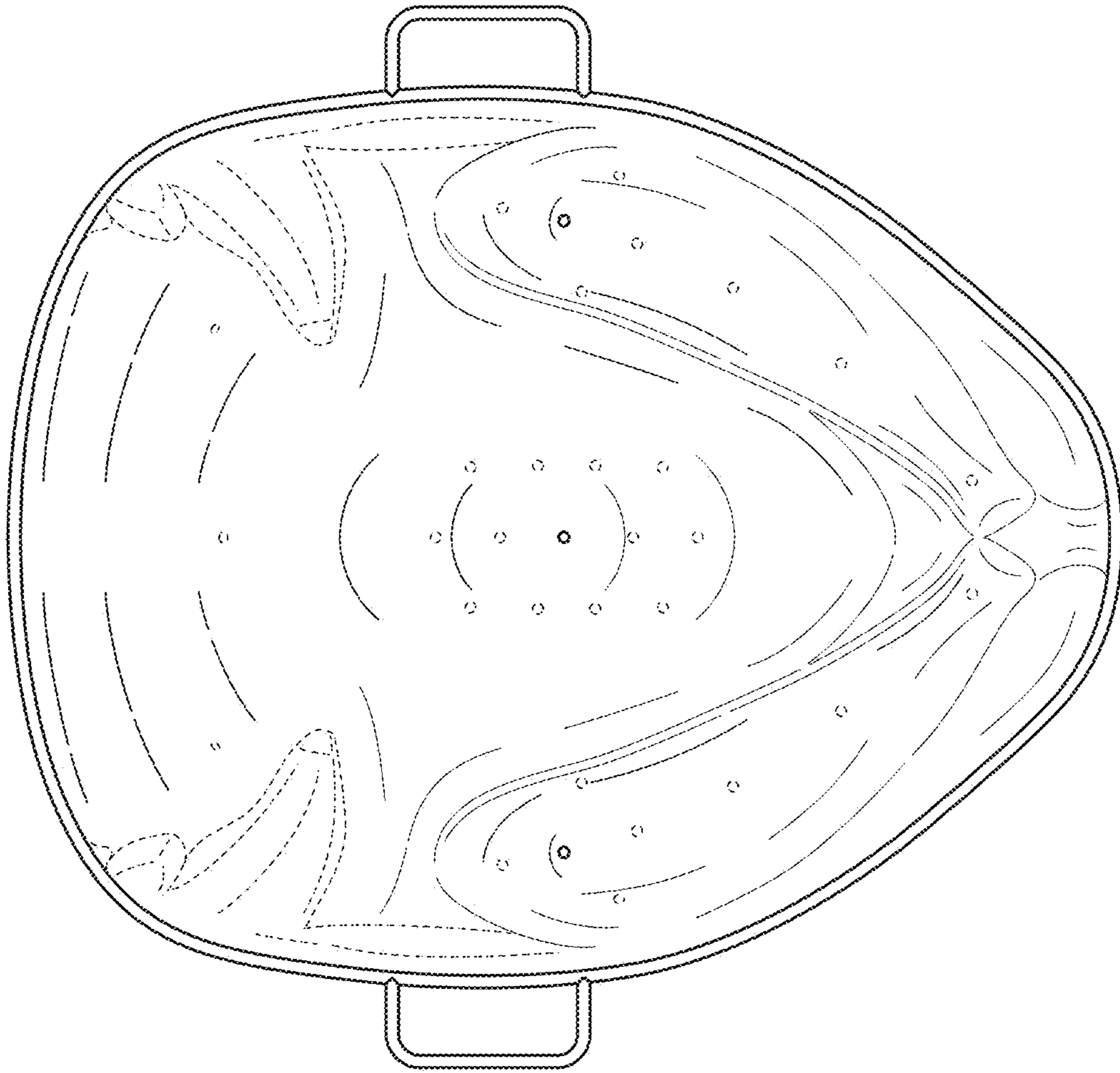

FIG. 1

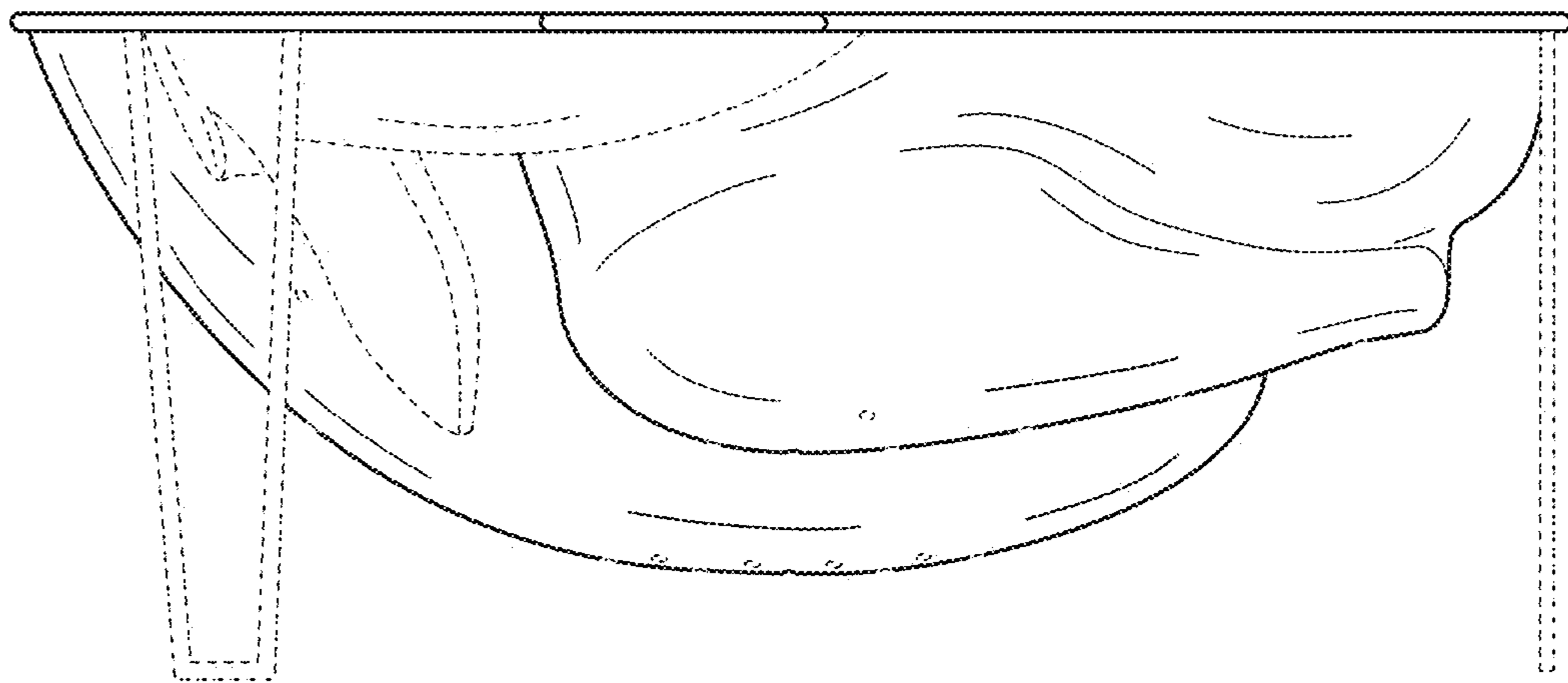

FIG. 2

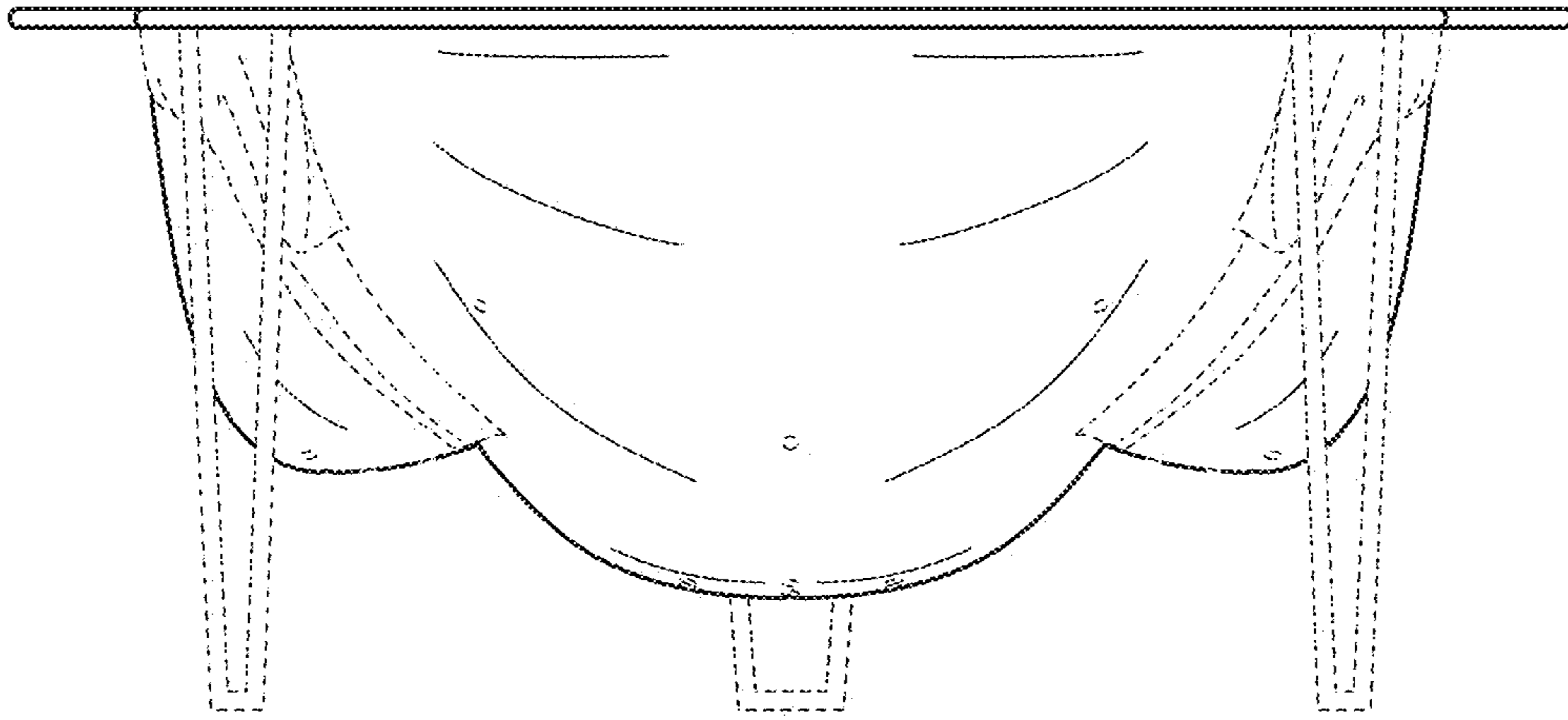

FIG. 3

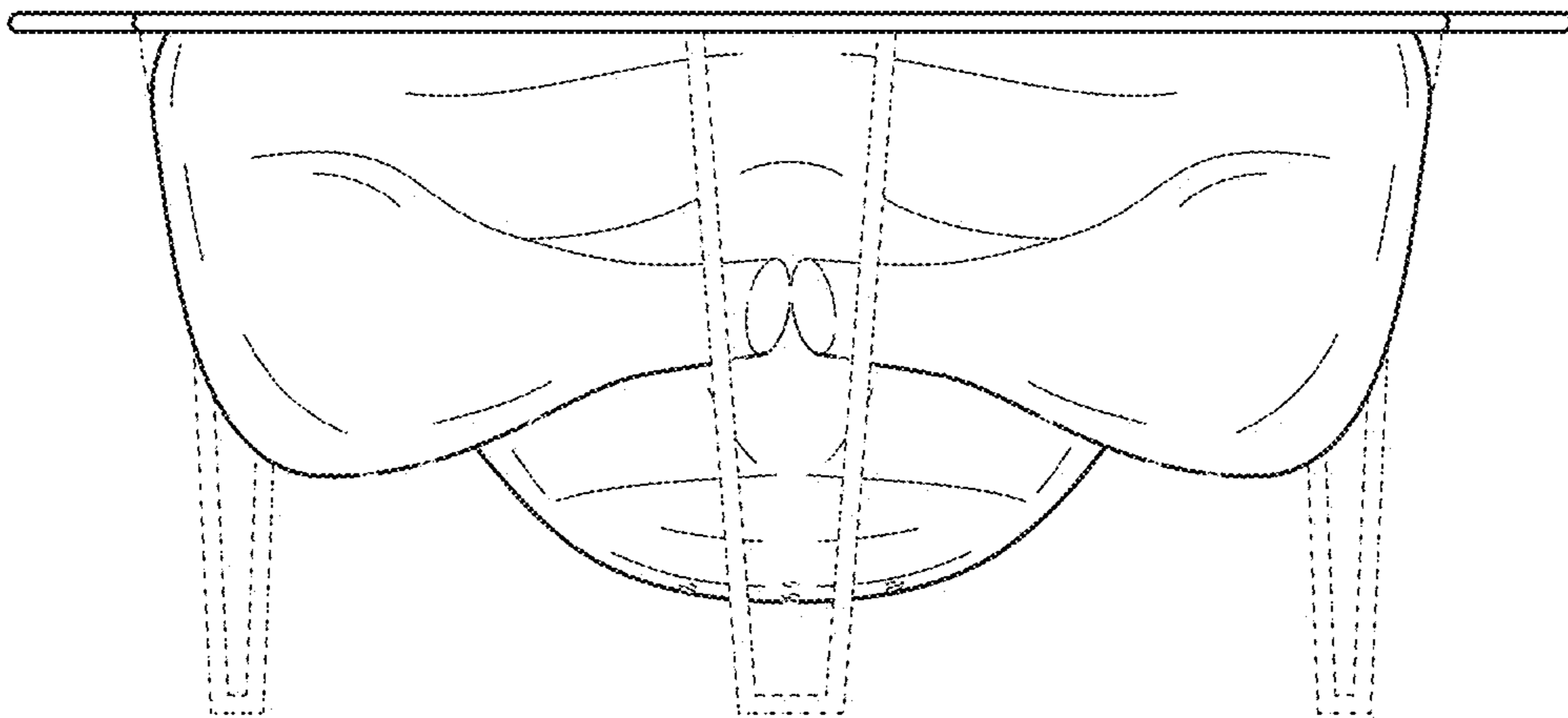

FIG. 4

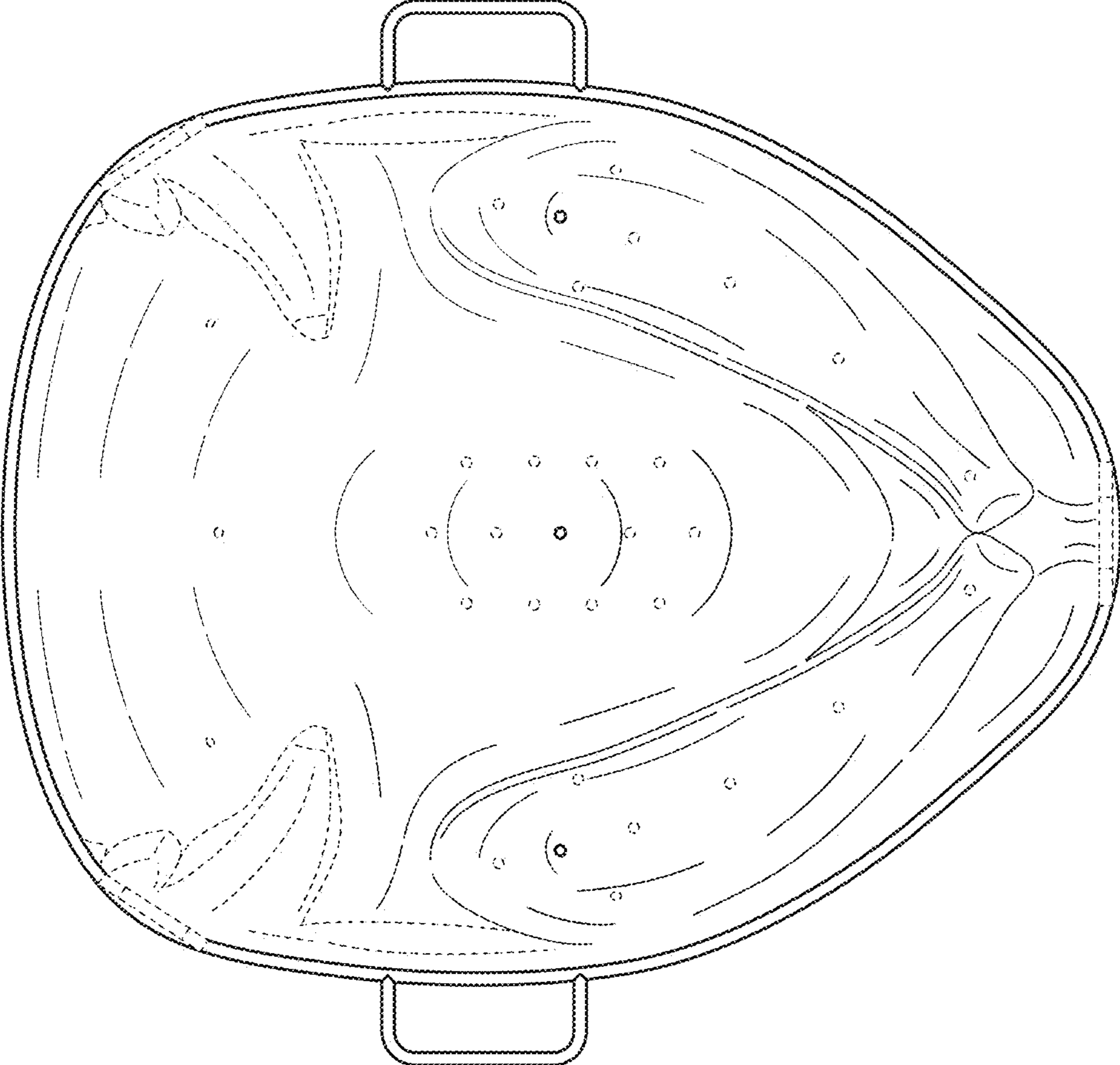

FIG. 5