

US00D979306S

(12) **United States Design Patent**  
**Godwin**

(10) **Patent No.:** **US D979,306 S**

(45) **Date of Patent:** **\*\* Feb. 28, 2023**

(54) **TABLE**

(71) Applicant: **Alumni Classroom Furniture Inc.**,  
Waterloo (CA)

(72) Inventor: **Paul Godwin**, Waterloo (CA)

(73) Assignee: **Alumni Classroom Furniture Inc.**,  
Waterloo (CA)

(\*\*) Term: **15 Years**

(21) Appl. No.: **29/649,604**

(22) Filed: **May 31, 2018**

**Related U.S. Application Data**

(63) Continuation-in-part of application No. 29/601,114,  
filed on Apr. 19, 2017, now Pat. No. Des. 834,865.

(51) **LOC (14) Cl.** ..... **06-06**

(52) **U.S. Cl.**  
USPC ..... **D6/707.22**

(58) **Field of Classification Search**  
USPC .... D6/338, 641, 656, 656.1, 656.13, 656.15,  
D6/656.18, 685, 686, 687, 691.1, 691.6,  
D6/692.1, 693, 696, 696.1, 696.3, 696.4,  
D6/697, 697.1, 697.2, 704, 705.1, 707,  
D6/707.21, 707.22, 707.23, 708.24  
(Continued)

(56) **References Cited**

**U.S. PATENT DOCUMENTS**

D144,045 S \* 3/1946 Fletcher ..... D6/650  
D148,776 S \* 2/1948 Fay ..... D6/644  
(Continued)

**OTHER PUBLICATIONS**

Balt Economy Shapes Desk & Essential Chair Package—  
Quo0007465 | Collaborative Des . . . ; www.worthingtondirect.com/

desks/quo0005473-economy-shapes-desk-essential-chair-package-  
5-desks-5-16-h-chairs.htm; available online at least as early as Dec.  
6, 2016.

(Continued)

*Primary Examiner* — Catherine Ho

(74) *Attorney, Agent, or Firm* — Laurie Wright;  
Christopher N. Hunter; Blake, Cassels & Graydon LLP

(57) **CLAIM**

The ornamental design of a table, as shown and described.

**DESCRIPTION**

FIG. 1 is a perspective view of the first embodiment of a  
table, showing our new design;

FIG. 2 is top view thereof;

FIG. 3 is a bottom view thereof;

FIG. 4 is a side view thereof;

FIG. 5 is an opposite side view thereof;

FIG. 6 is a perspective view of the first embodiment of a  
table in an alternative configuration;

FIG. 7 is a perspective view of one of the components of the  
first embodiment of a table isolated for clarity of illustration;

FIG. 8 is a perspective view of a second embodiment of a  
table;

FIG. 9 is top view thereof;

FIG. 10 is a bottom view thereof;

FIG. 11 is a side view thereof;

FIG. 12 is an opposite side view thereof;

FIG. 13 is a perspective view of the second embodiment of  
a table in an alternative configuration; and,

FIG. 14 is a perspective view of one of the components of  
the second embodiment of a table isolated for clarity of  
illustration.

The even-spaced broken line portions of the figures are  
included to show portions of the article that form no part of  
the claimed design. The dash-dot broken lines define the  
bounds of the claimed design and form no part thereof.

**1 Claim, 14 Drawing Sheets**

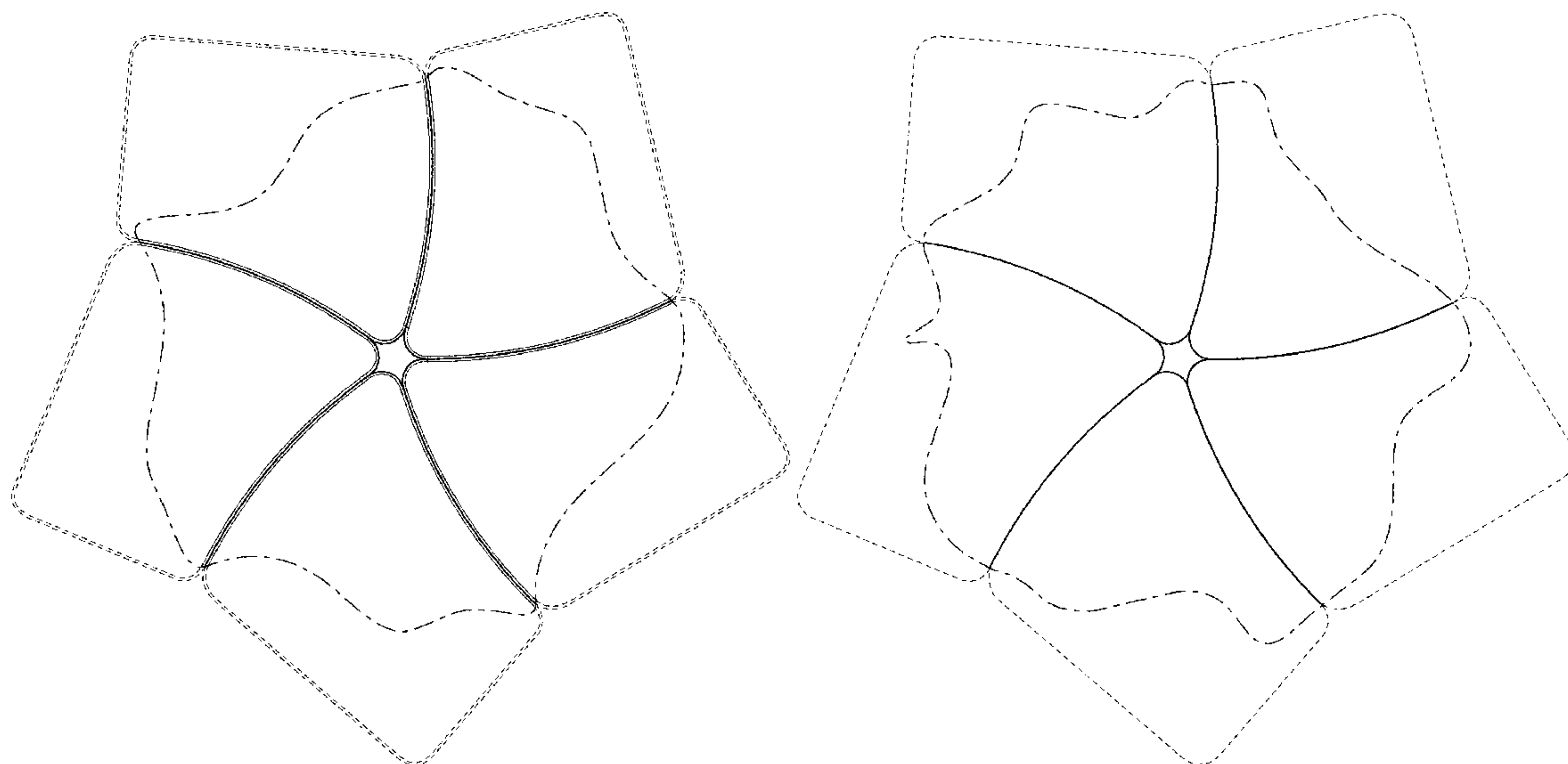

(58) **Field of Classification Search**

CPC .... A47B 3/00; A47B 7/00; A47B 7/02; A47B  
13/00; A47B 13/08; A47B 21/00; A47B  
21/02; A47B 41/00; A47B 41/02; A47B  
2200/0001; A47B 2200/0003; A47B  
2200/0035

See application file for complete search history.

D770,207	S	11/2016	Legare	
D774,338	S	12/2016	Legare	
D792,135	S *	7/2017	Wyman	D6/691.1
D810,485	S *	2/2018	Teller	D6/707.23
D834,865	S *	12/2018	Godwin	D6/707.22
D839,648	S *	2/2019	Legare	D6/707
D859,895	S *	9/2019	Haase	D6/707.22
D860,698	S *	9/2019	Godwin	D6/707.22
2013/0129405	A1	5/2013	Everett	

(56) **References Cited**

U.S. PATENT DOCUMENTS

D190,998	S *	8/1961	Schultz	D6/688
D280,368	S	9/1985	Crespi	
D332,536	S *	1/1993	Hosoe	D6/693.1
5,438,937	A *	8/1995	Ball	A47B 87/002 108/64
D413,212	S	8/1999	Dame et al.	
D414,634	S	10/1999	Smith et al.	
D415,375	S	10/1999	McCrackin et al.	
7,004,082	B2 *	2/2006	Yang	A47B 37/04 108/50.12
D588,671	S	3/2009	Ball et al.	
D594,682	S	6/2009	Burak	
D703,984	S	5/2014	Nasseri et al.	
8,776,699	B2	7/2014	Nasseri et al.	
D736,021	S	8/2015	Legare	

OTHER PUBLICATIONS

Flow Desk, hosted at Web.archive.org, posted on May 22, 2016, online, site visited Oct. 19, 2017. Available from <https://web.archive.org/web/20160522144817/http://www.alumnif.com/ecommerce/desks/flow/Flow-Desk.htm>.

Shapes Desk w/ White Dry Erase Top, hosted at Web.archive.org, posted on Mar. 30, 2015, online, site visited Oct. 19, 2017. Available from <https://web.archive.org/web/20150330053539/http://www.worthingtondirect.com/desks/shapes-desk-w-white-dry-erase-top-by-balt.htm>.

Shapes Desk by Balt, hosted at Web.archive.org, posted on Aug. 29, 2014, online, site visited Oct. 19, 2017. Available from <https://web.archive.org/web/20140829061931/http://www.worthingtondirect.com/desks/shapes-desk.htm>.

\* cited by examiner

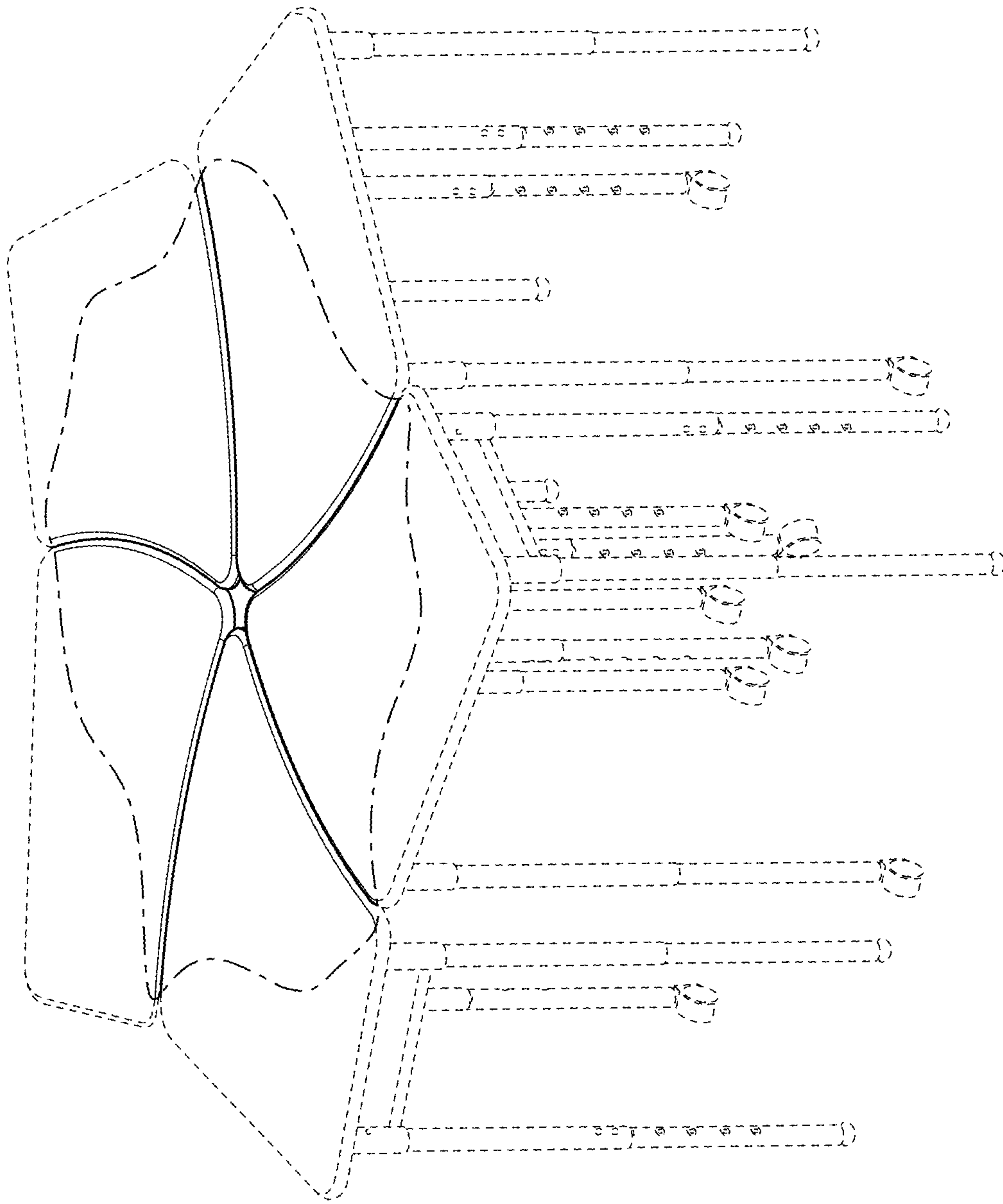

FIG. 1

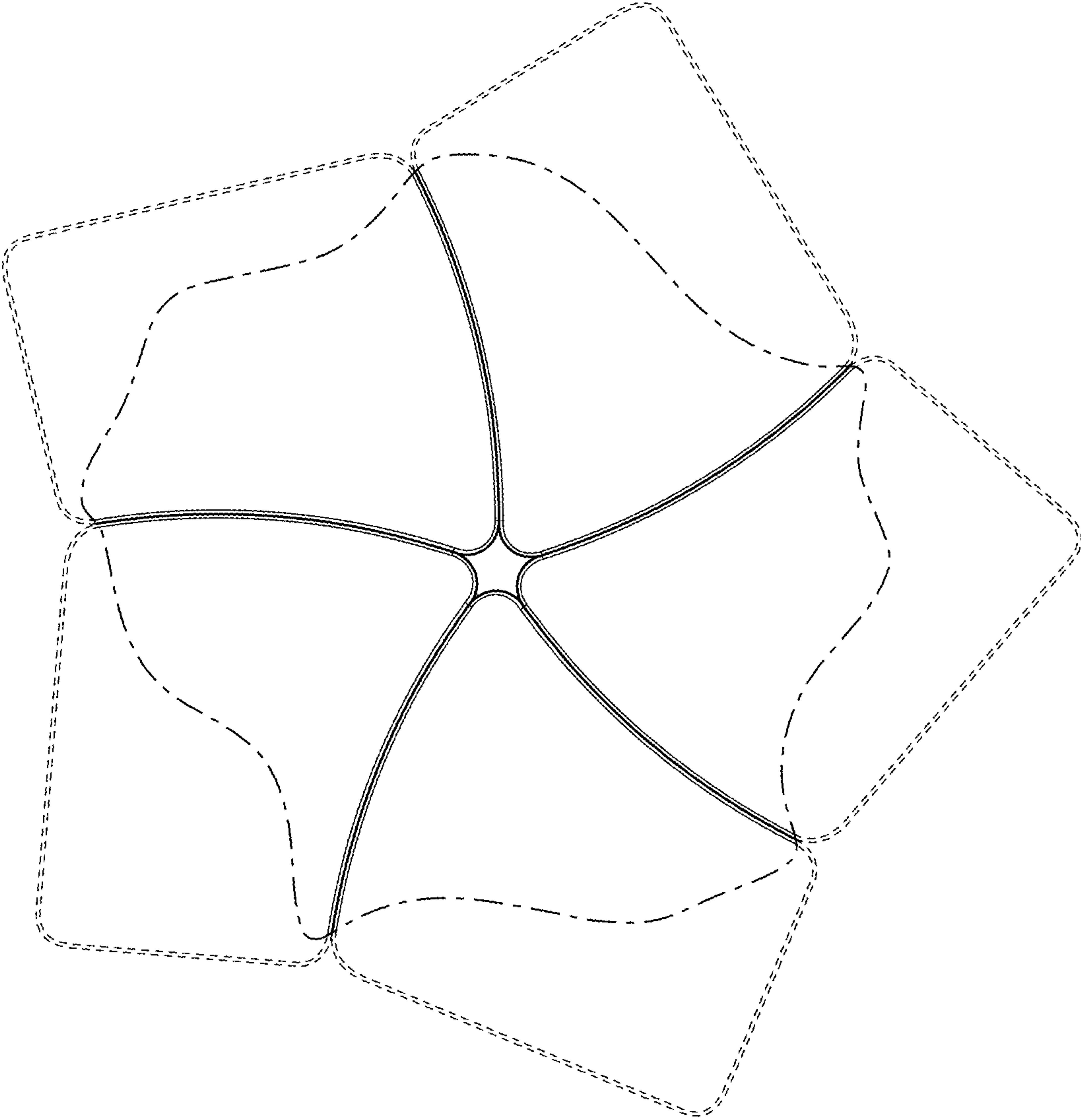

FIG. 2



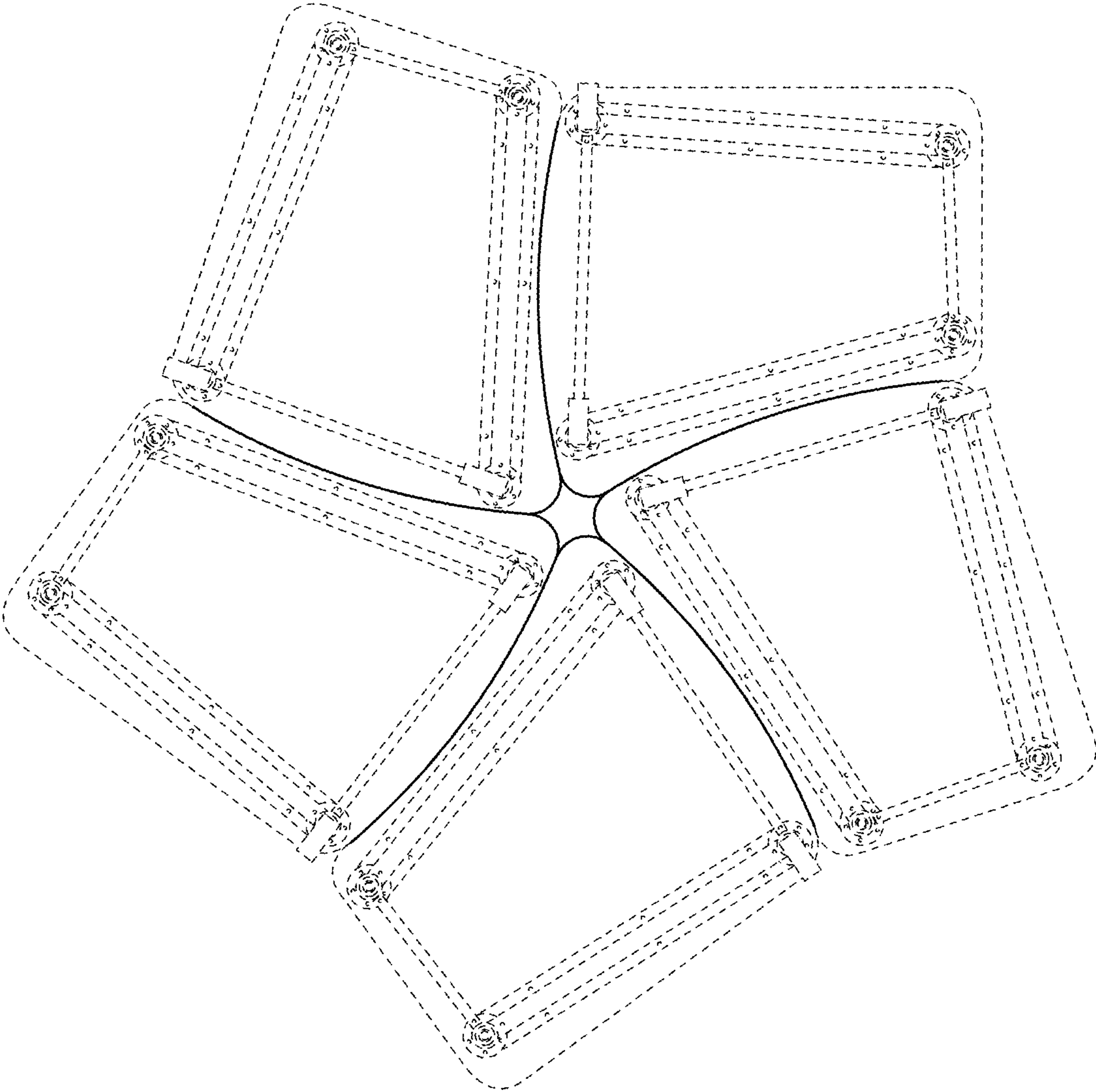

FIG. 3

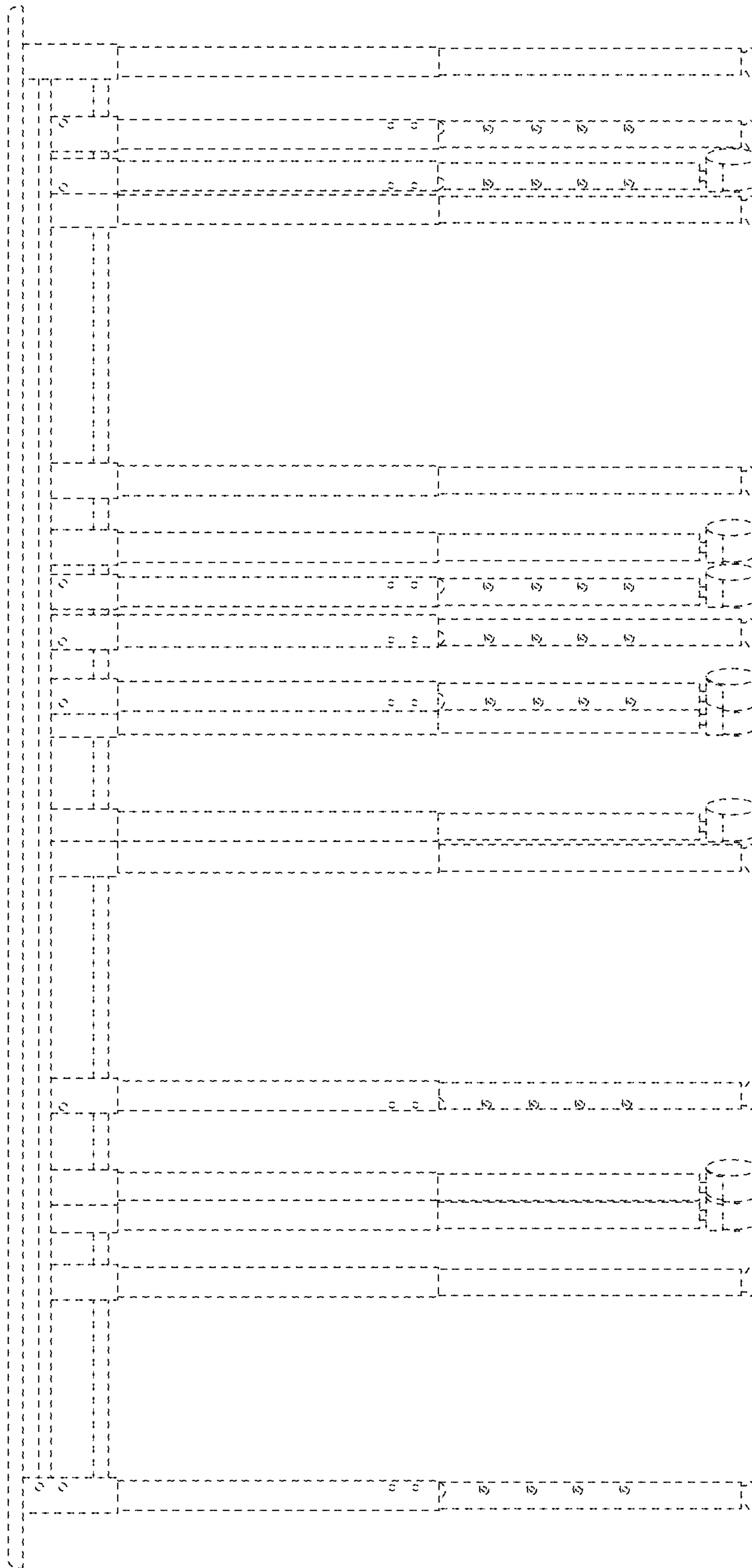

FIG. 4

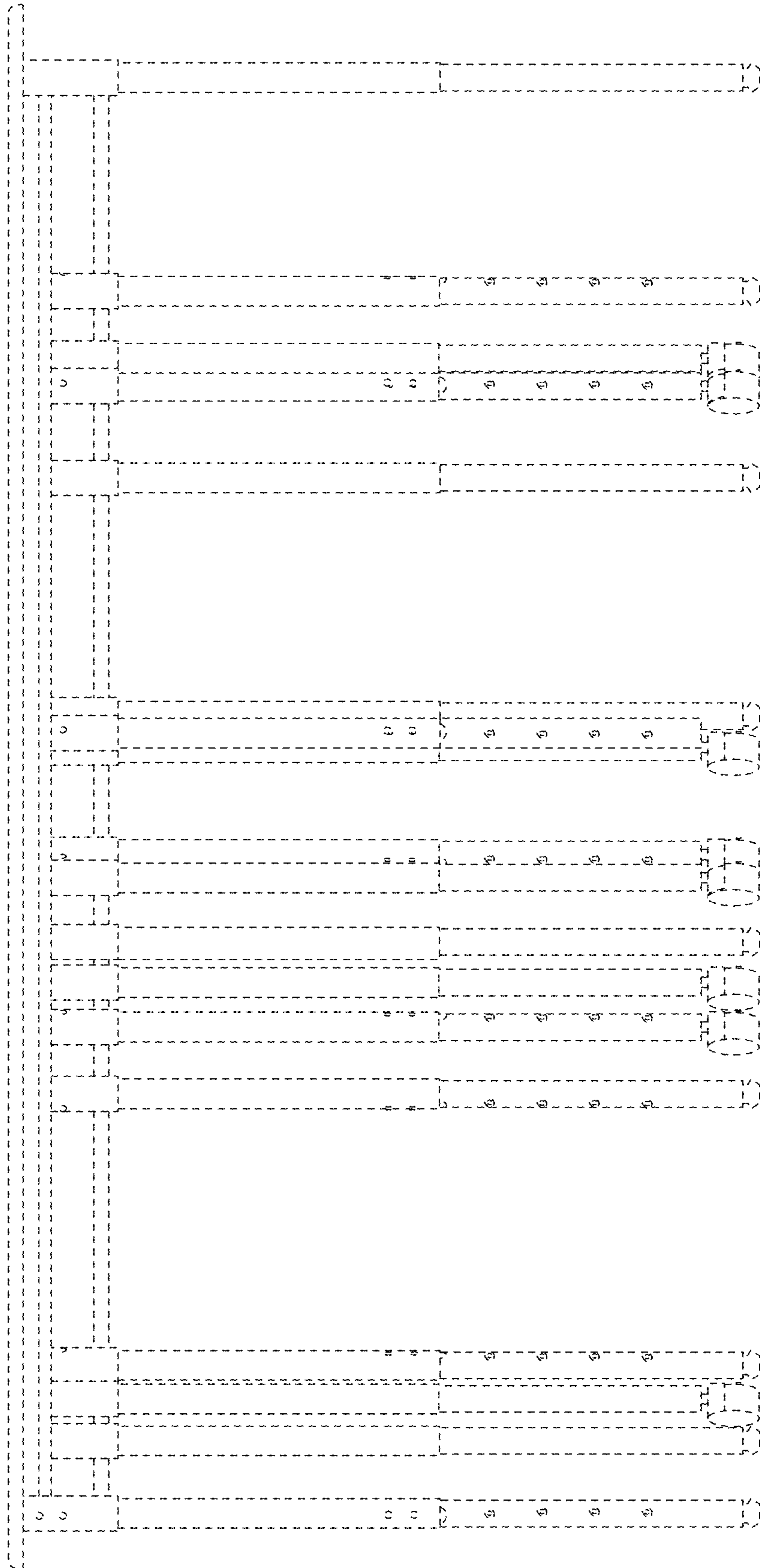

FIG. 5

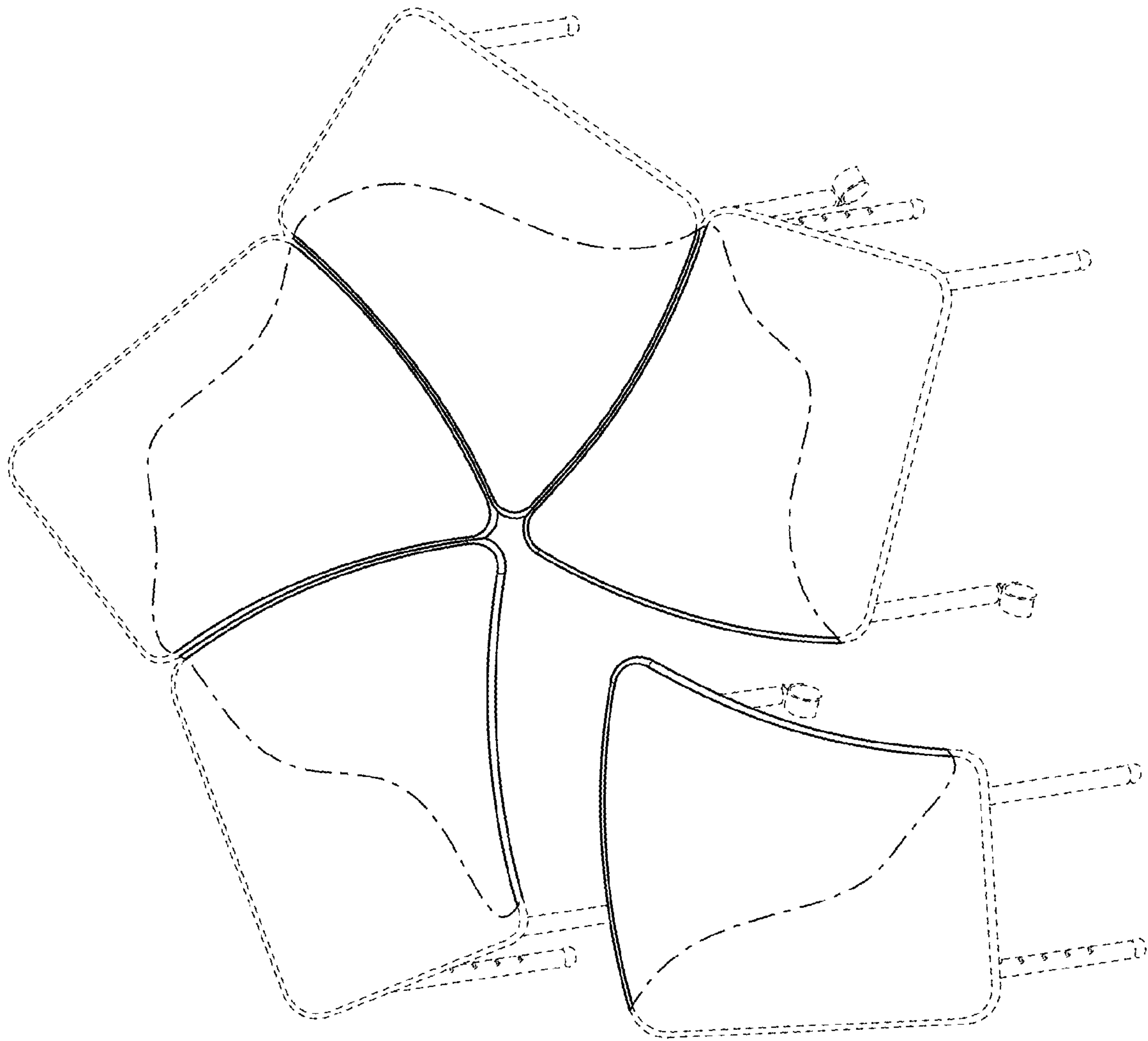

FIG. 6



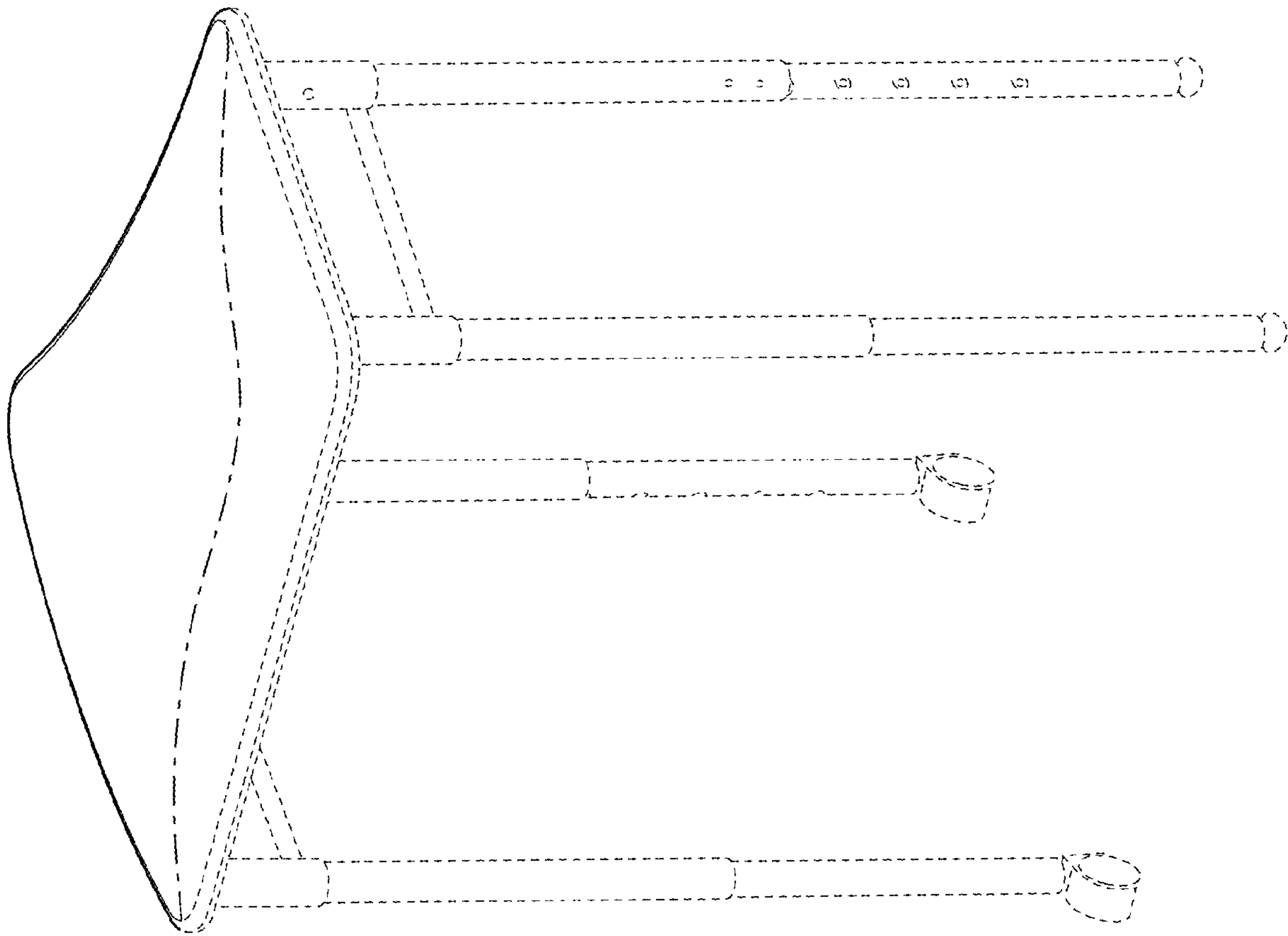

FIG. 7

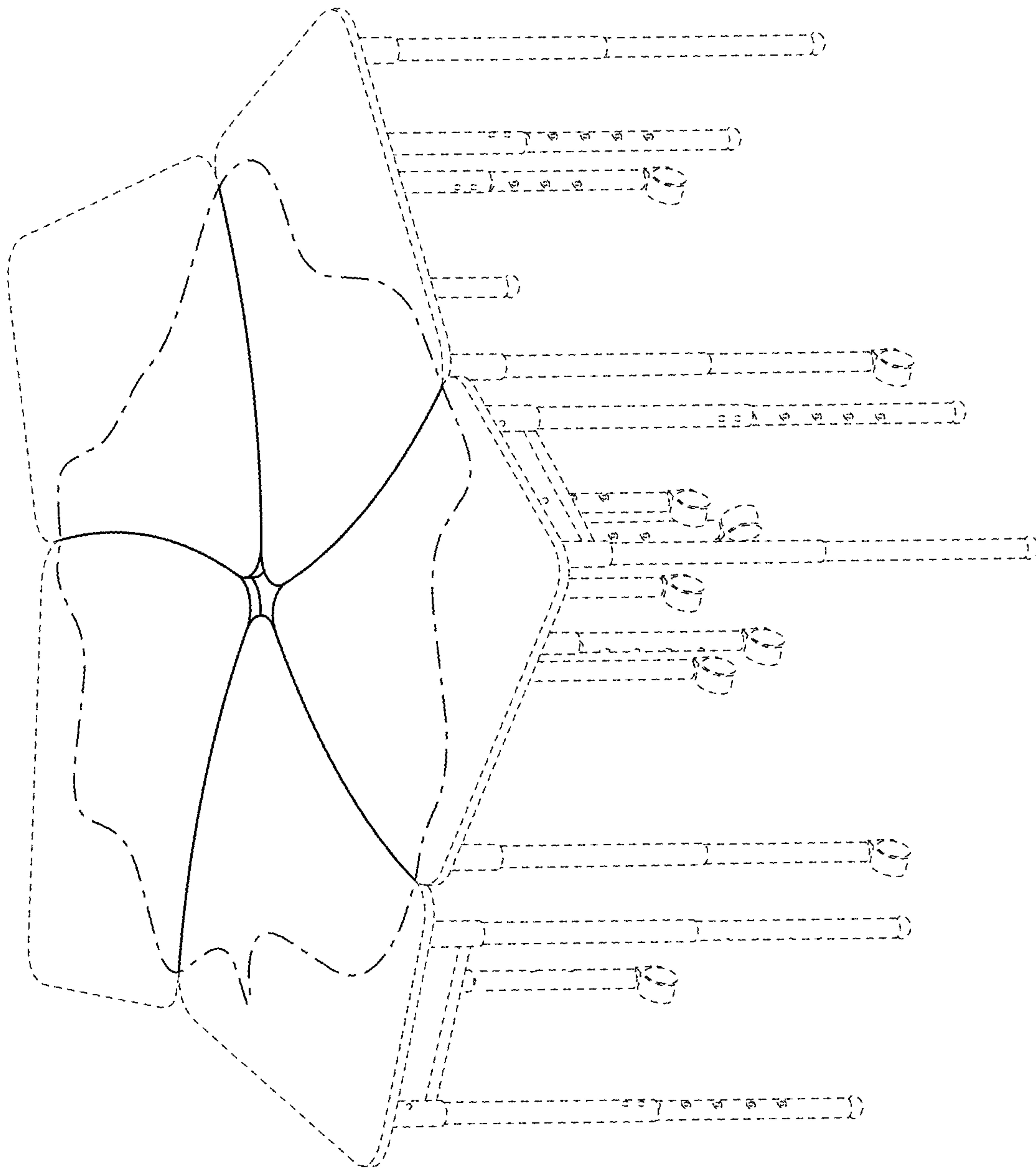

FIG. 8

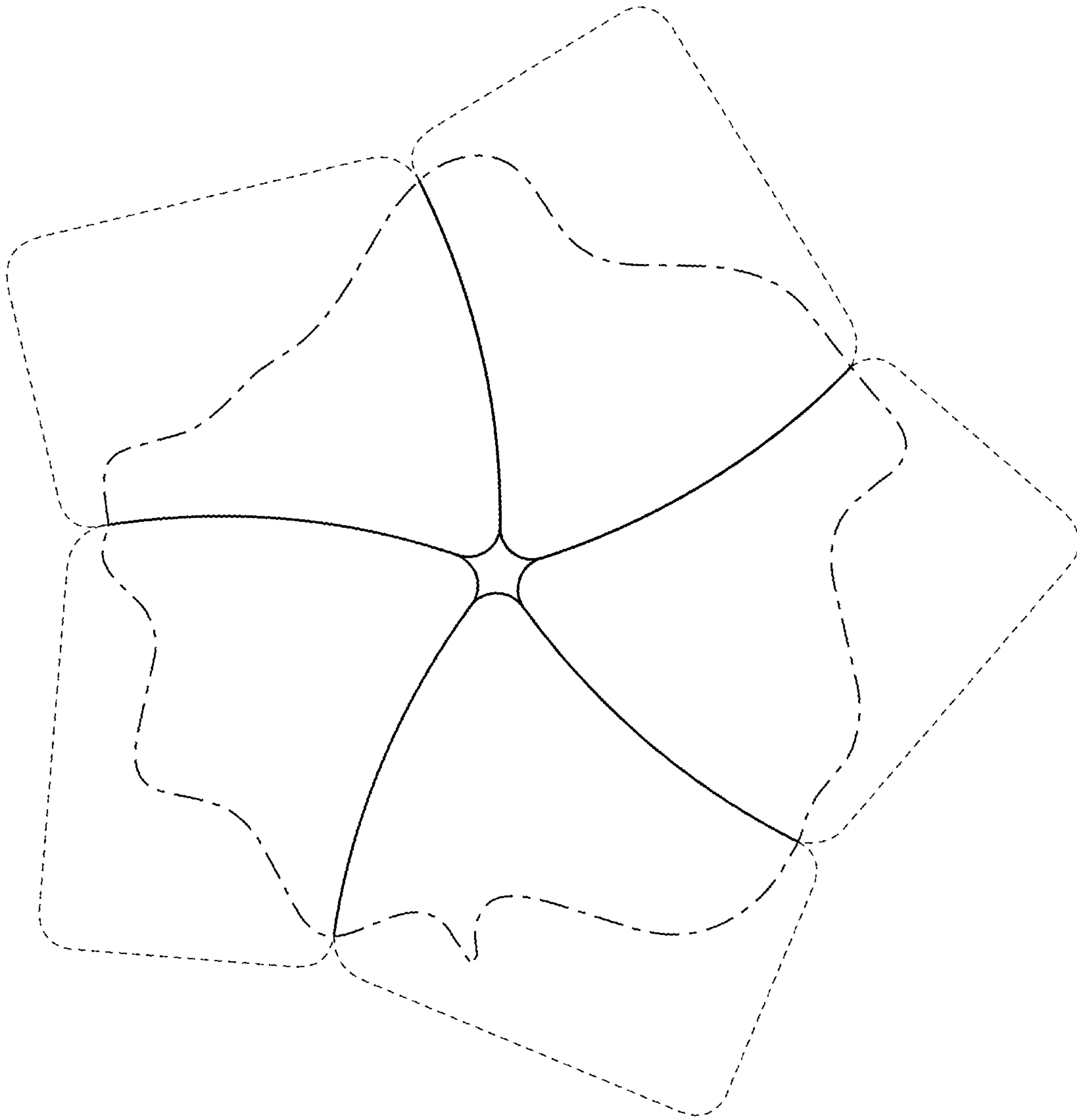

FIG. 9

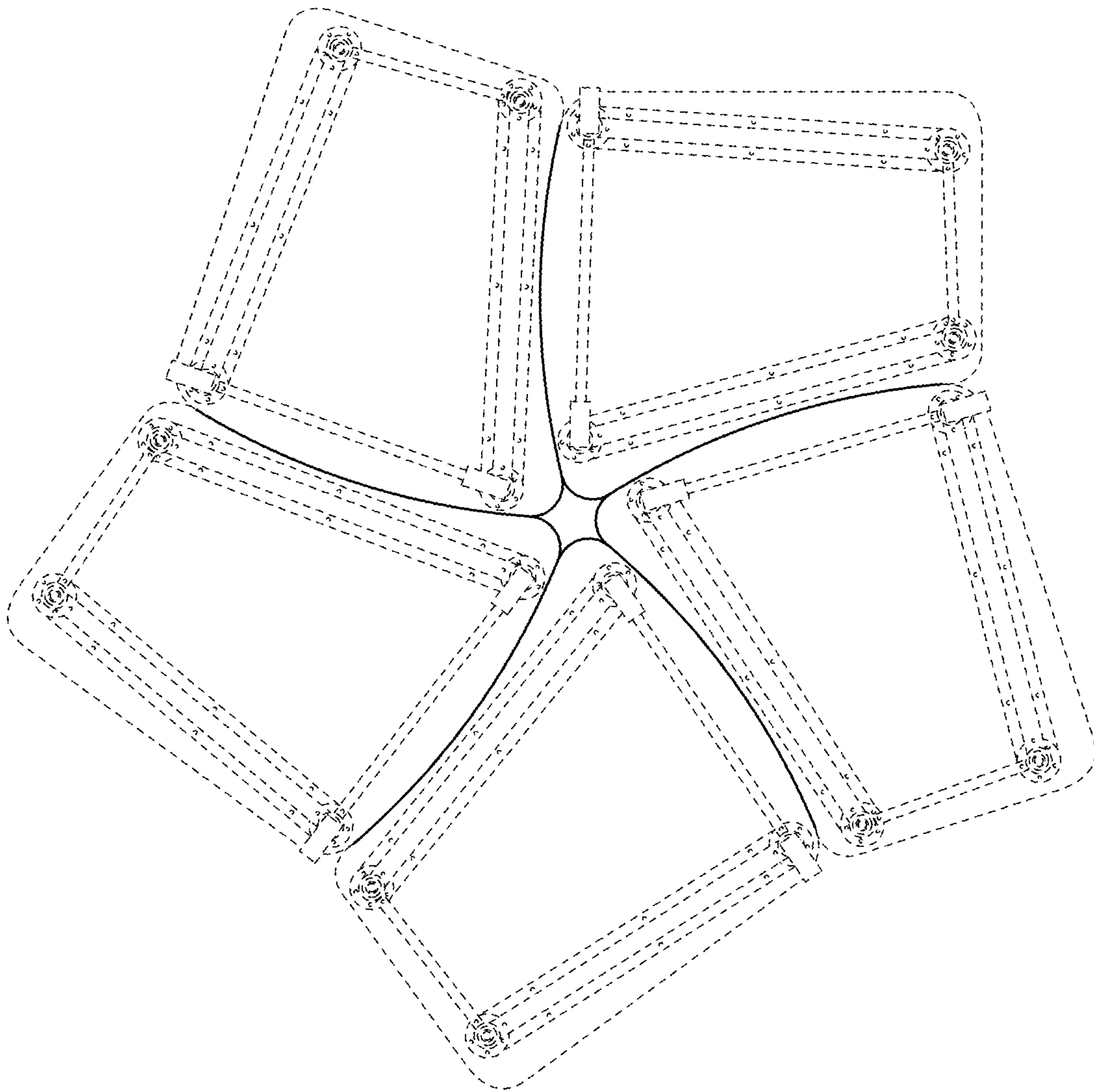

FIG. 10

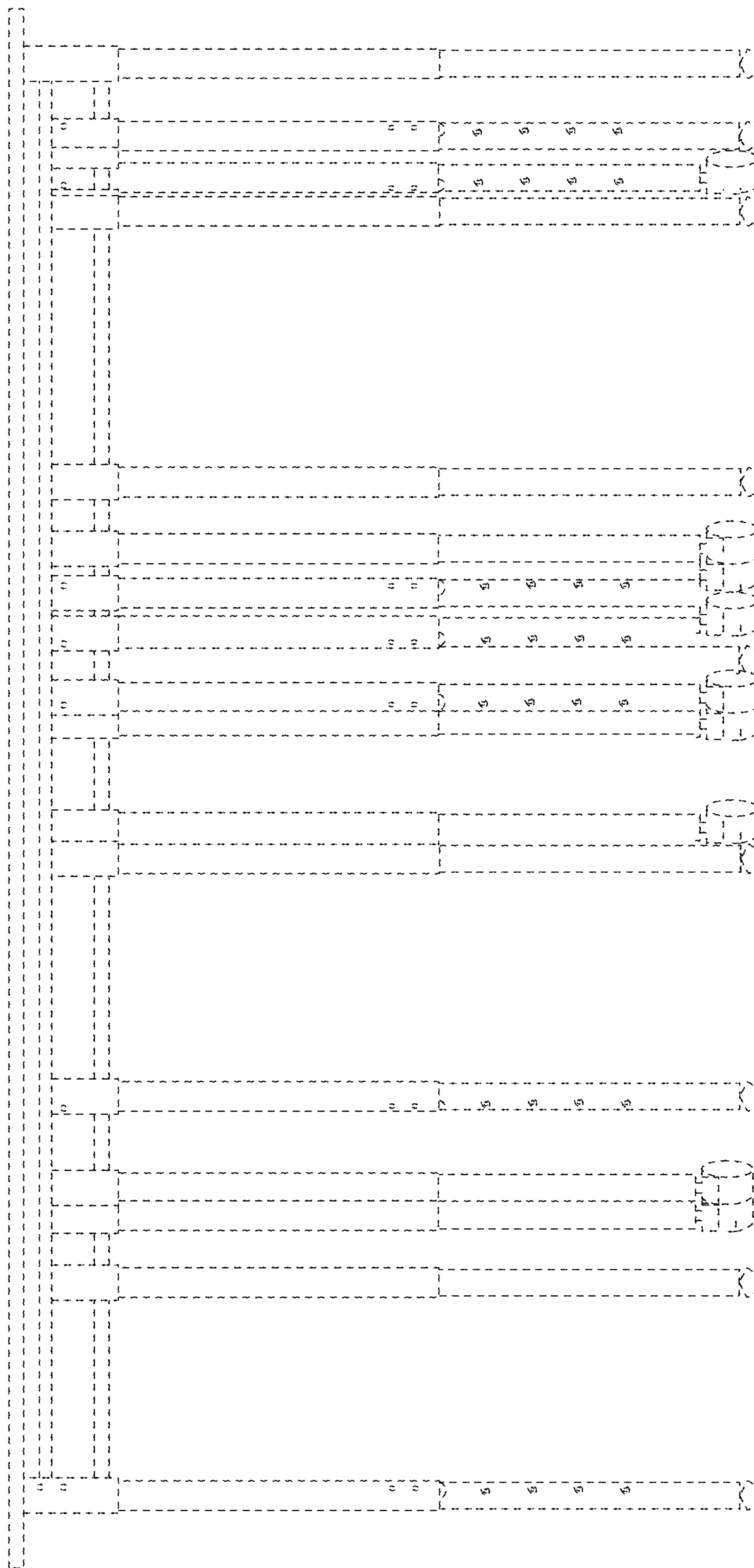

FIG. 11



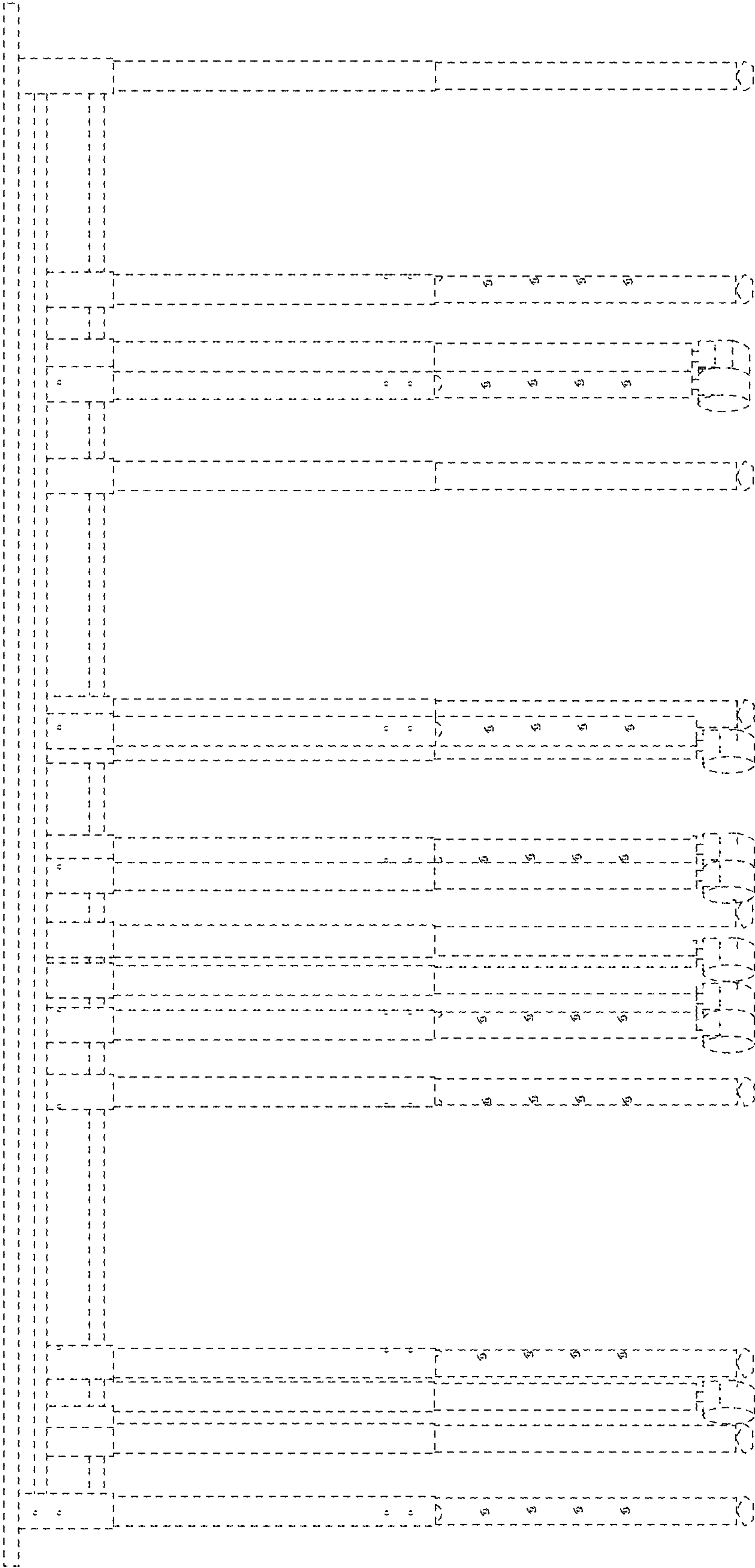

FIG. 12

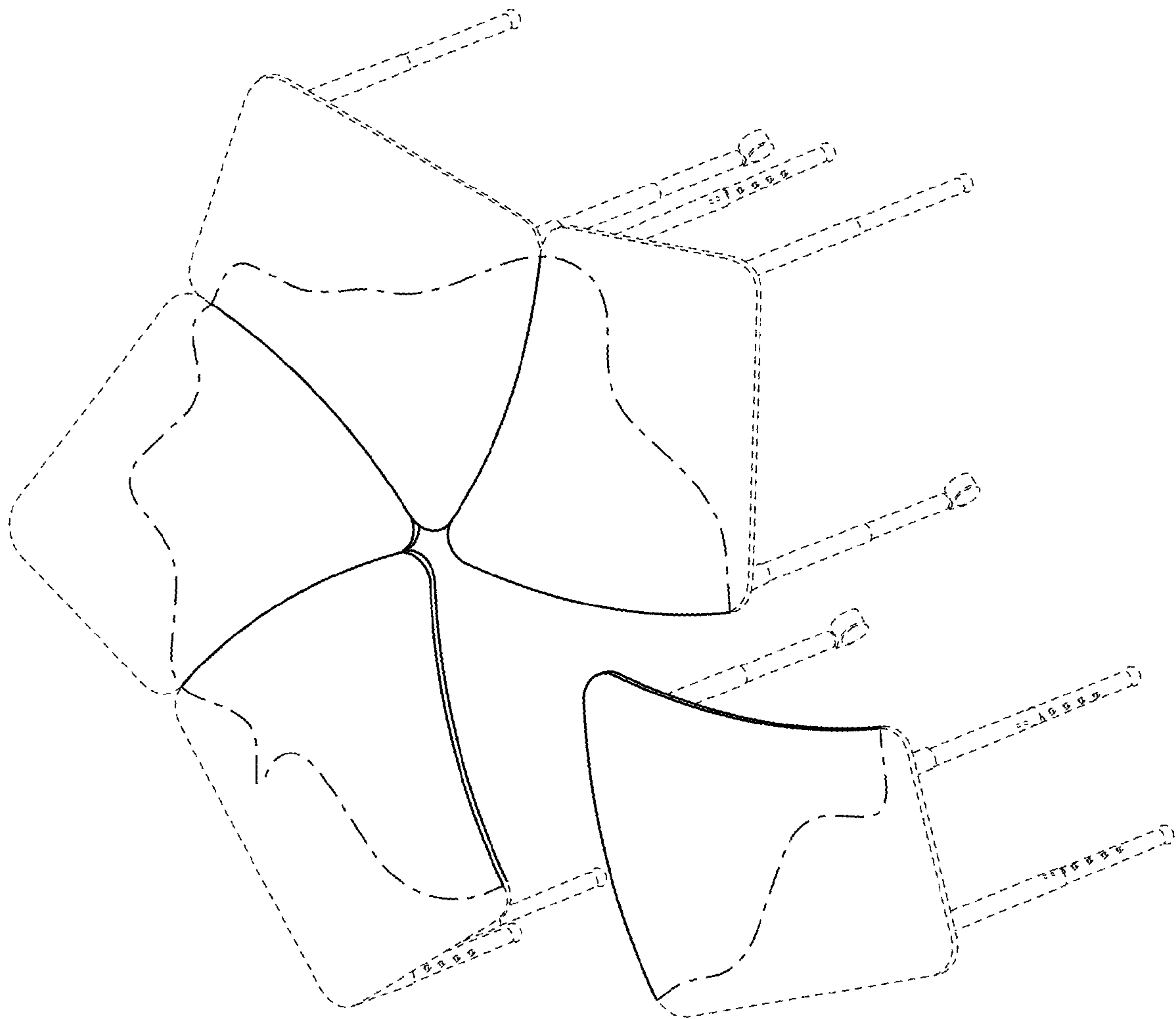

FIG. 13

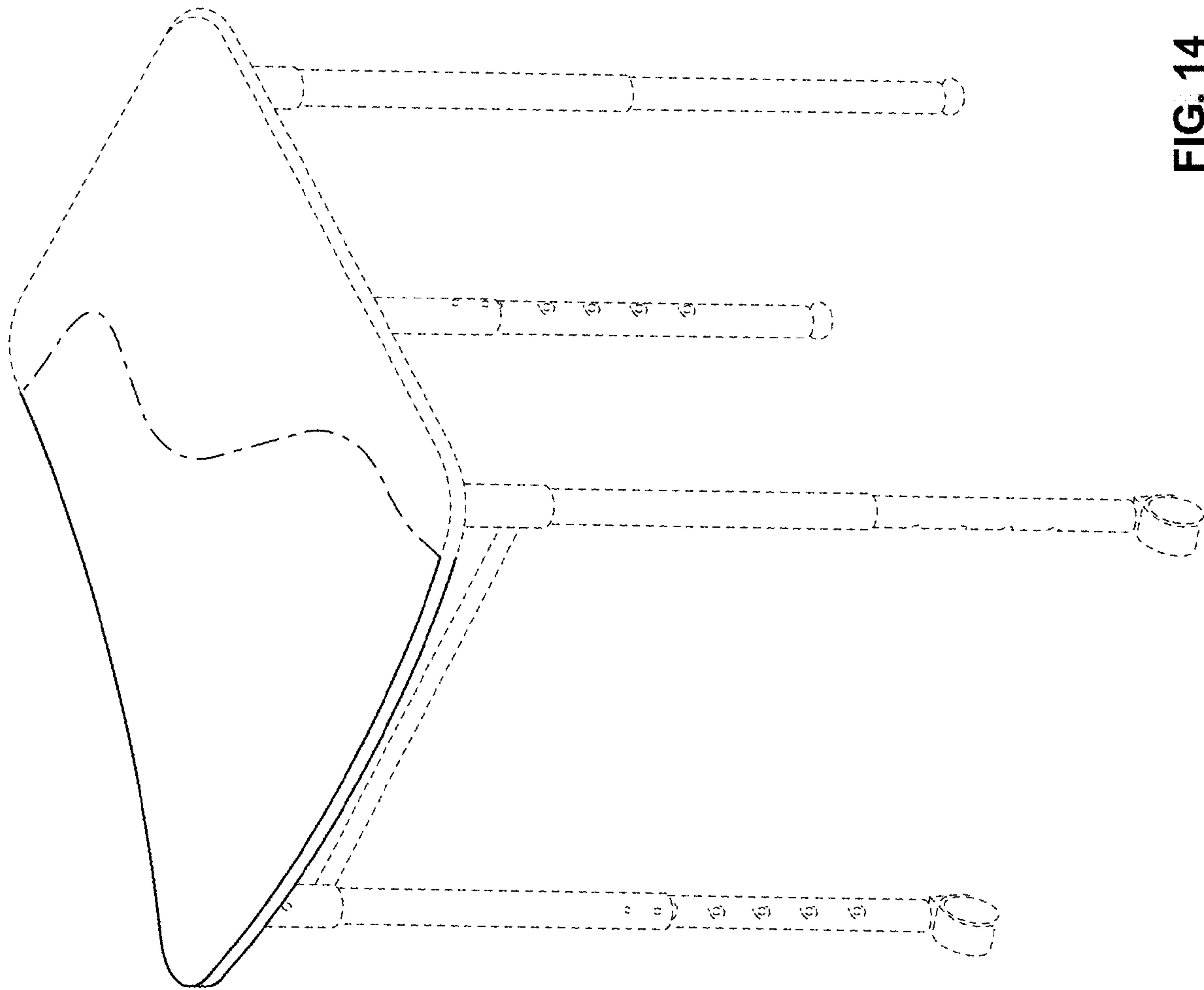

FIG. 14