



US00D979291S

(12) **United States Design Patent** (10) **Patent No.:** **US D979,291 S**  
**Bohaty et al.** (45) **Date of Patent:** **\*\* Feb. 28, 2023**

(54) **TOWEL**

(71) Applicant: **With Love LIA, LLC**, Irvington, NY (US)

(72) Inventors: **Amy M. Bohaty**, Tarrytown, NY (US);  
**Lisa Distefano**, Armonk, NY (US)

(73) Assignee: **WITH LOVE LIA, LLC**, Irvington, NY (US)

(\*\*) Term: **15 Years**

(21) Appl. No.: **29/781,915**

(22) Filed: **May 3, 2021**

(51) **LOC (14) Cl.** ..... **06-99**

(52) **U.S. Cl.**  
USPC ..... **D6/608**

(58) **Field of Classification Search**  
USPC ..... D6/608; D2/718, 720, 723, 756, 826,  
D2/860

(Continued)

(56) **References Cited**

**U.S. PATENT DOCUMENTS**

4,656,670 A 4/1987 Schluter  
4,669,128 A 6/1987 Furgang

(Continued)

**FOREIGN PATENT DOCUMENTS**

EM 001220594-0001 B 6/2010  
WO 2009076078 A1 6/2009

**OTHER PUBLICATIONS**

Bath wrap Towel, posted Jul. 21, 2020 [online], [retrieved Aug. 2, 2022], Retrieved from internet, <https://www.amazon.com/Zexxy-Womens-Anti-Slip-After-Shower-Quick-Dry> (Year: 2020).\*

(Continued)

*Primary Examiner* — Cynthia Ramirez

*Assistant Examiner* — Carrie A Matteoli

(74) *Attorney, Agent, or Firm* — Fredrikson & Byron, P.A

(57) **CLAIM**

The ornamental design for a towel, as shown and described.

**DESCRIPTION**

FIG. 1 is an enlarged perspective view of a first embodiment of our new design for a towel in a first configuration; FIG. 2 is a perspective view in a second configuration; FIG. 3 is a perspective view in a third configuration; FIG. 4 is a front view thereof; FIG. 5 is a rear view thereof; FIG. 6 is a side view thereof; FIG. 7 is an opposite side view thereof; FIG. 8 is a top view thereof; FIG. 9 is a bottom view thereof; FIG. 10 is an enlarged perspective view in a fourth configuration; FIG. 11 is an enlarged perspective view of a second embodiment of our new design for a towel in a first configuration; FIG. 12 is a perspective view in a second configuration; FIG. 13 is a perspective view in a third configuration; FIG. 14 is a front view thereof; FIG. 15 is a rear view thereof; FIG. 16 is a side view thereof; FIG. 17 is an opposite side view thereof; FIG. 18 is a top view thereof; FIG. 19 is a bottom view thereof; FIG. 20 is an enlarged perspective view in a fourth configuration; FIG. 21 is an enlarged perspective view of a third embodiment of our new design for a towel in a first configuration; FIG. 22 is a perspective view in a second configuration; FIG. 23 is a perspective view in a third configuration; FIG. 24 is a front view thereof; FIG. 25 is a rear view thereof; FIG. 26 is a side view thereof; FIG. 27 is an opposite side view thereof; FIG. 28 is a top view thereof; FIG. 29 is a bottom view thereof;

(Continued)

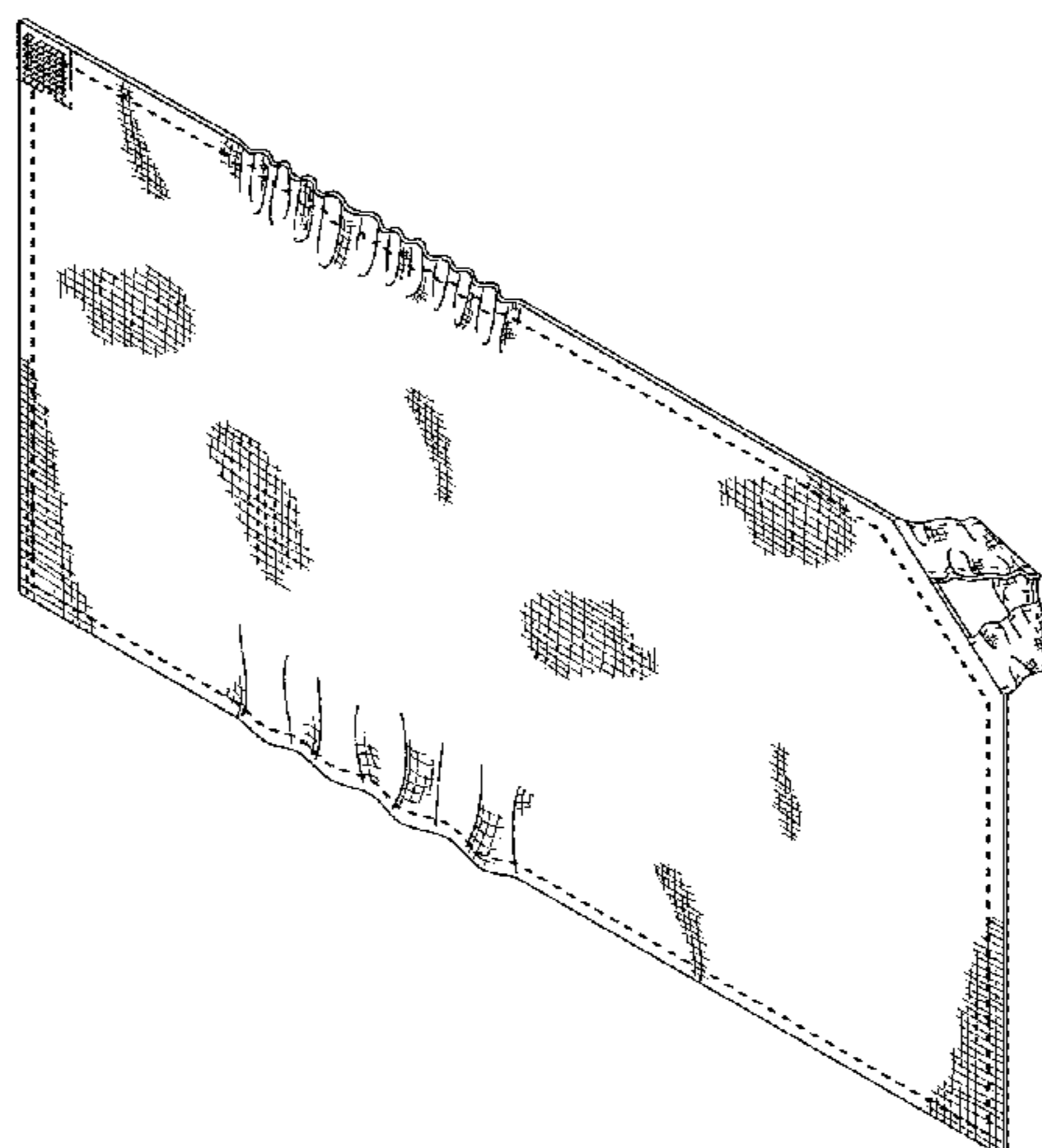


FIG. 30 is an enlarged perspective view in a fourth configuration;  
 FIG. 31 is an enlarged perspective view of a fourth embodiment of our new design for a towel in a first configuration;  
 FIG. 32 is a perspective view in a second configuration;  
 FIG. 33 is a perspective view in a third configuration;  
 FIG. 34 is a front view thereof;  
 FIG. 35 is a rear view thereof;  
 FIG. 36 is a side view thereof;  
 FIG. 37 is an opposite side view thereof;  
 FIG. 38 is a top view thereof;  
 FIG. 39 is a bottom view thereof;  
 FIG. 40 is an enlarged perspective view in a fourth configuration;  
 FIG. 41 is an enlarged perspective view of a fifth embodiment of our new design for a towel in a first configuration;  
 FIG. 42 is a perspective view in a second configuration;  
 FIG. 43 is a perspective view in a third configuration;  
 FIG. 44 is a front view thereof;  
 FIG. 45 is a rear view thereof;  
 FIG. 46 is a side view thereof;  
 FIG. 47 is an opposite side view thereof;  
 FIG. 48 is a top view thereof;  
 FIG. 49 is a bottom view thereof;  
 FIG. 50 is an enlarged perspective view in a fourth configuration;  
 FIG. 51 is an enlarged perspective view of a sixth embodiment of our new design for a towel in a first configuration;  
 FIG. 52 is a perspective view in a second configuration;  
 FIG. 53 is a perspective view in a third configuration;  
 FIG. 54 is a front view thereof;  
 FIG. 55 is a rear view thereof;  
 FIG. 56 is a side view thereof;  
 FIG. 57 is an opposite side view thereof;  
 FIG. 58 is a top view thereof;  
 FIG. 59 is a bottom view thereof;  
 FIG. 60 is an enlarged perspective view in a fourth configuration;  
 FIG. 61 is an enlarged perspective view of a seventh embodiment of our new design for a towel in a first configuration;  
 FIG. 62 is a perspective view in a second configuration;  
 FIG. 63 is a perspective view in a third configuration;  
 FIG. 64 is a front view thereof;  
 FIG. 65 is a rear view thereof;  
 FIG. 66 is a side view thereof;  
 FIG. 67 is an opposite side view thereof;  
 FIG. 68 is a top view thereof;  
 FIG. 69 is a bottom view thereof;  
 FIG. 70 is an enlarged perspective view in a fourth configuration;

FIG. 71 is an enlarged perspective view of an eighth embodiment of our new design for a towel in a first configuration;  
 FIG. 72 is a perspective view in a second configuration;  
 FIG. 73 is a perspective view in a third configuration;  
 FIG. 74 is a front view thereof;  
 FIG. 75 is a rear view thereof;  
 FIG. 76 is a side view thereof;  
 FIG. 77 is an opposite side view thereof;  
 FIG. 78 is a top view thereof;  
 FIG. 79 is a bottom view thereof; and,  
 FIG. 80 is an enlarged perspective view in a fourth configuration.  
 The cross-hatching shading is fragmentarily shown for convenience of illustration, it being understood that the cross-hatching shading is uniformly continued over the surfaces on which it appears.  
 The dash-dash broken lines in the figures indicate stitching which is part of the claimed design. The longer dash-dash broken lines in the figures show portions of the towel which do not form part of the claimed design. The dash-dot-dot broken lines show environment and are not part of the claimed design.

**1 Claim, 64 Drawing Sheets**

(58) **Field of Classification Search**  
 CPC ..... A41D 15/00; A41D 1/14; A47K 10/02  
 See application file for complete search history.

(56) **References Cited**

U.S. PATENT DOCUMENTS

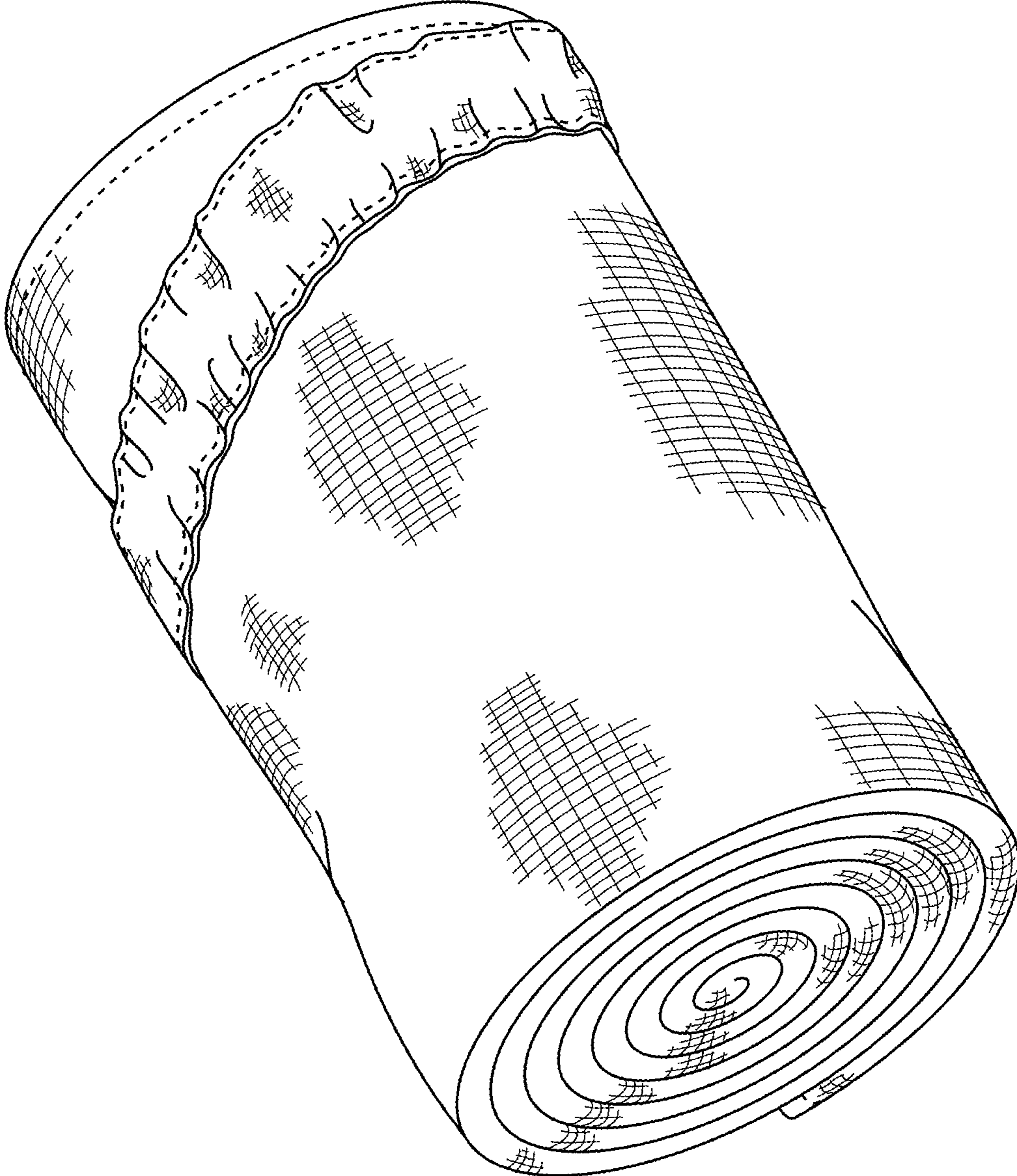
5,697,102	A	12/1997	Benjamin
6,006,356	A	12/1999	Song
D622,482	S	8/2010	Stein
D622,483	S	8/2010	Stein
D674,167	S	1/2013	Ehler
8,640,262	B2	2/2014	Rossi
2004/0093657	A1	12/2004	Erinc
2009/0144874	A1	6/2009	Stein
2009/0144924	A1	6/2009	Stein
2011/0314584	A1	12/2011	Wang

OTHER PUBLICATIONS

Webpage "<https://wearabletowel.com/uela>," "Wearable Towel Inc.," accessed on Jan. 5, 2021, 98 pgs.  
 Webpage "<https://www.amazon.in/Kanguru-high-Quality-Seconds-Convenient-Pocket/dp/B01469T5E2>," "Kanguru Smart Towel, The high-Quality Towel You can wear in 3 Seconds!," Mar. 3, 2017, 5 pages.

\* cited by examiner

**FIG. 1**



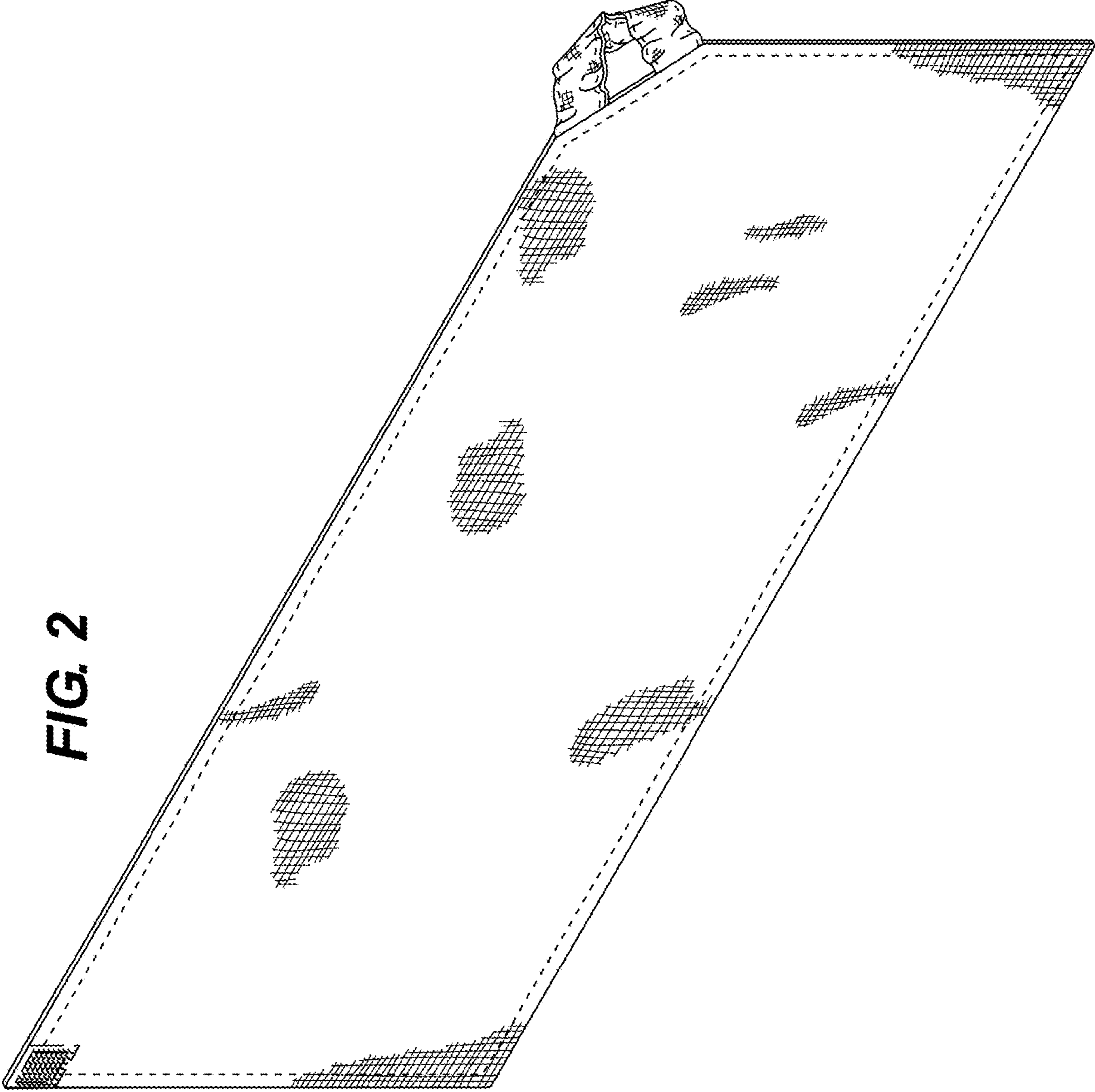
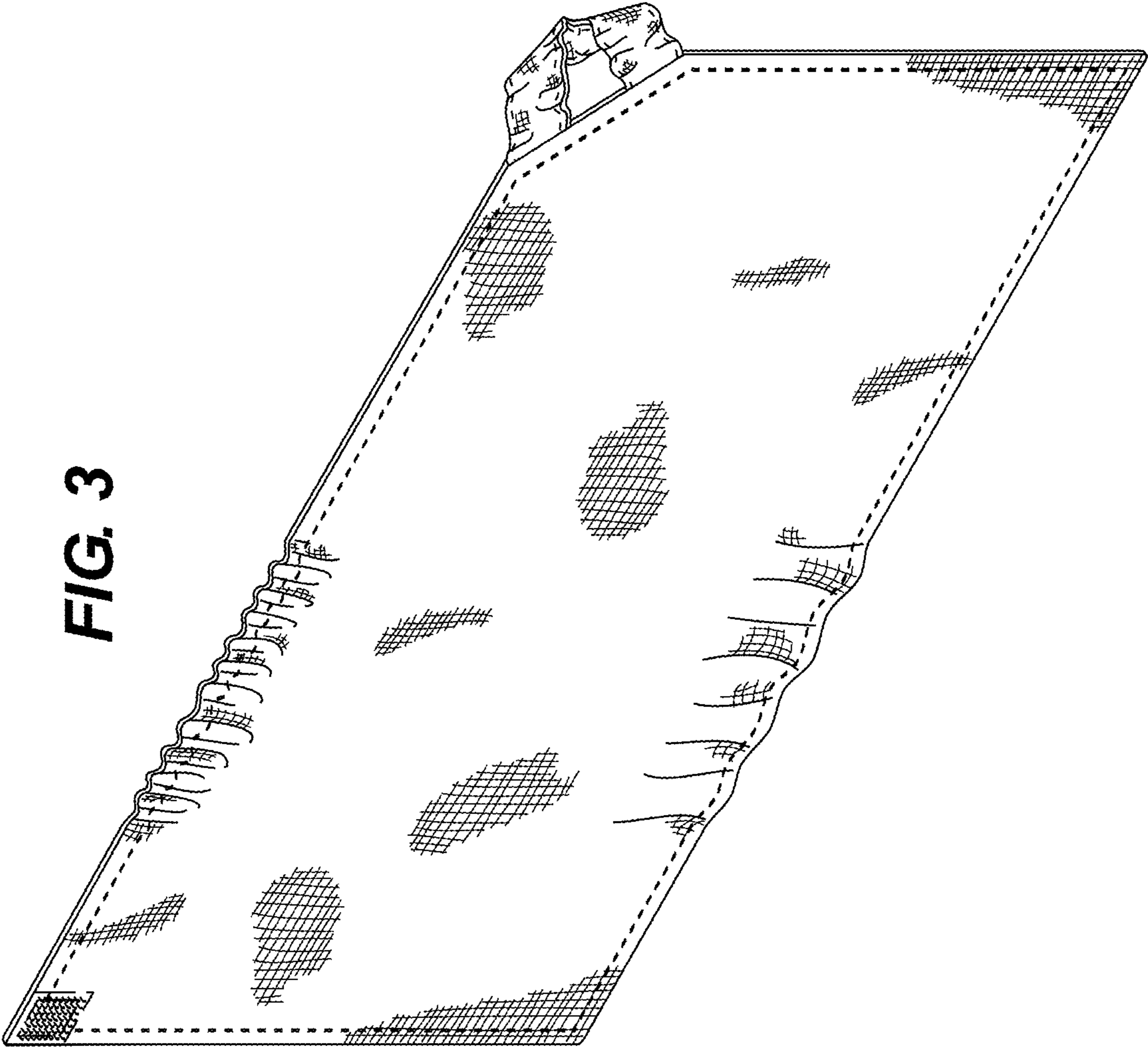
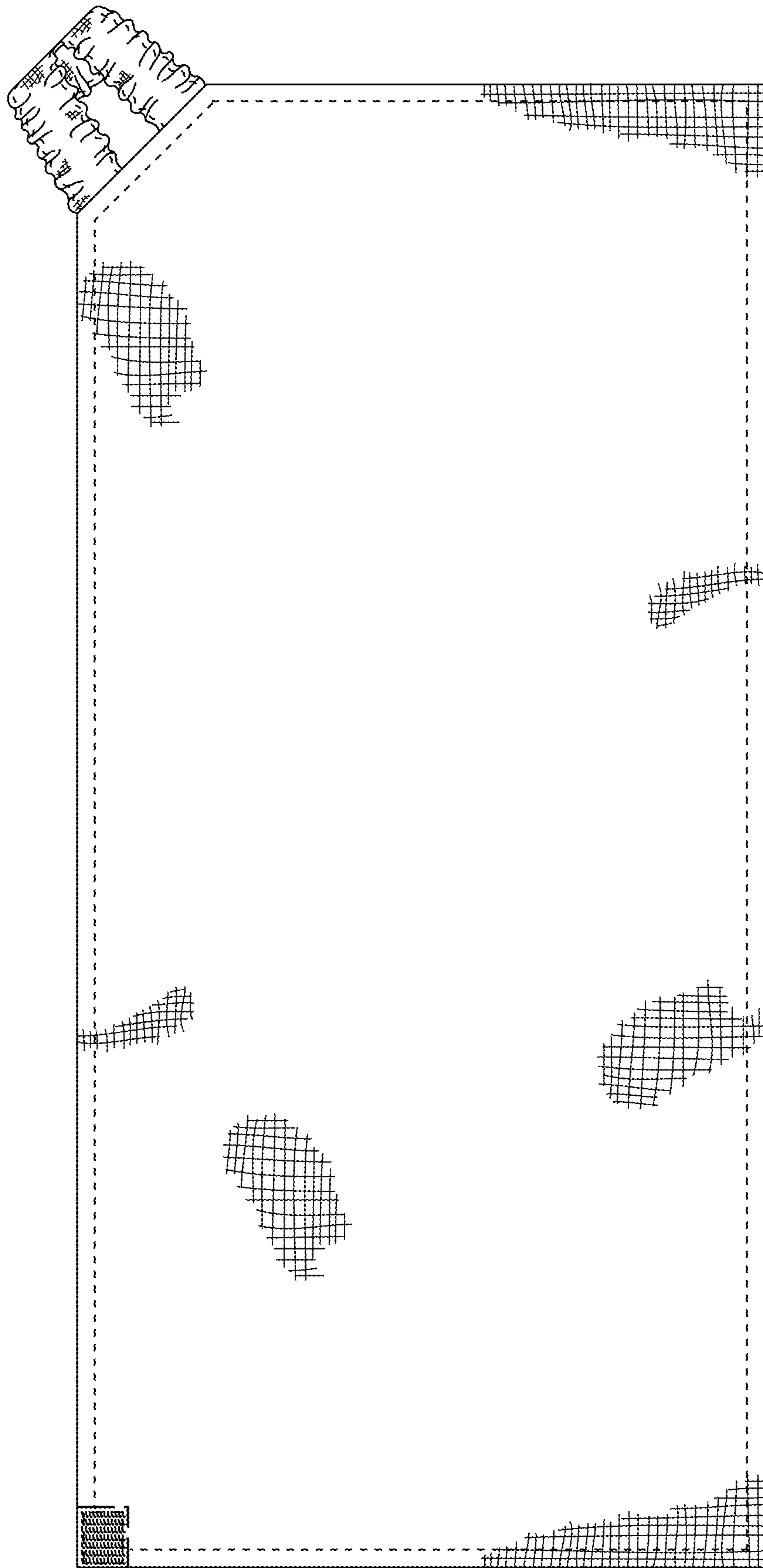


FIG. 2

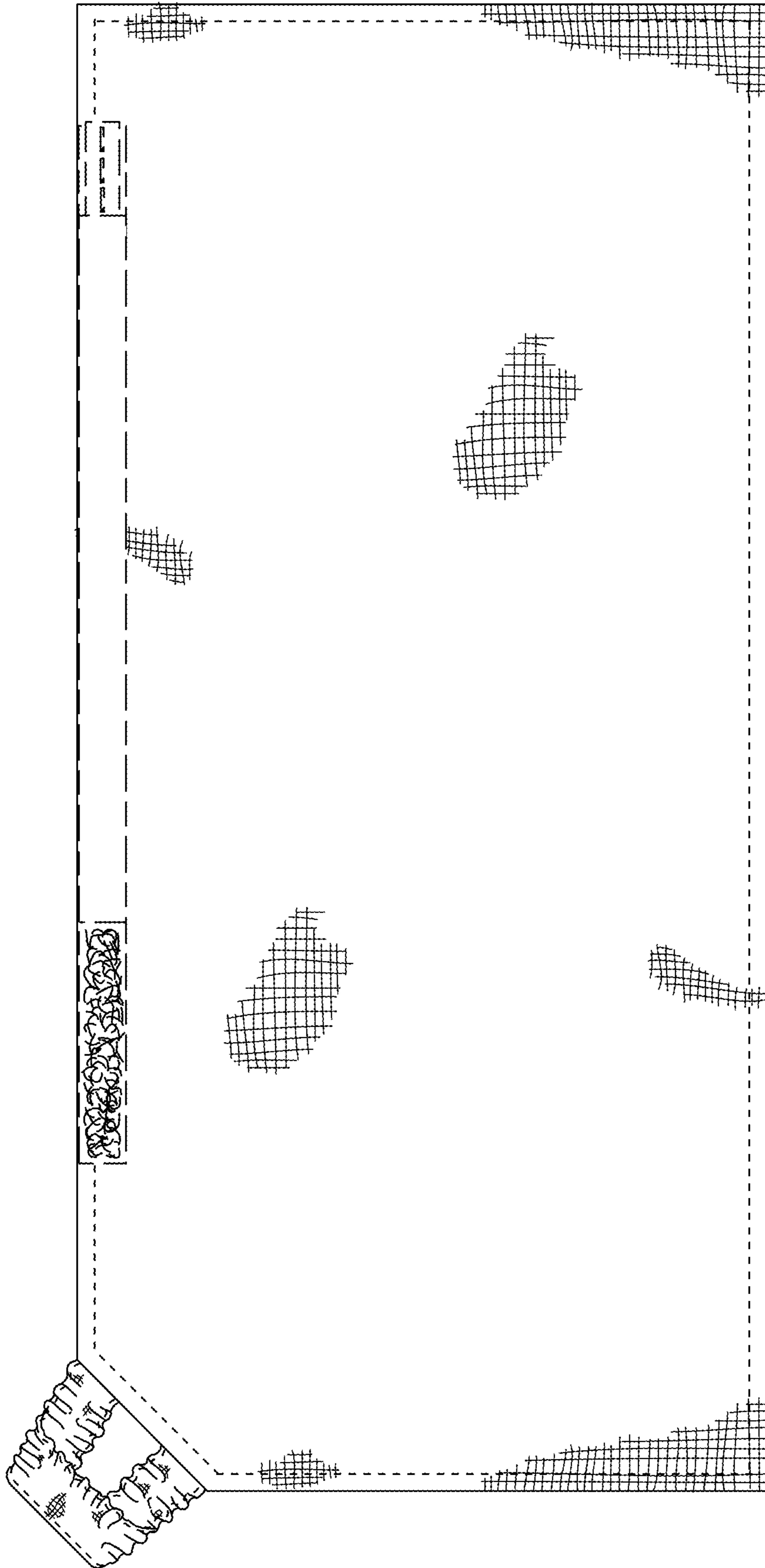


**FIG. 3**

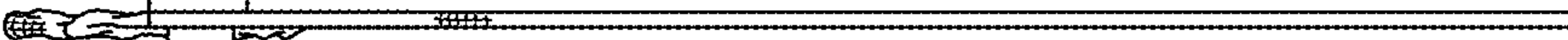
**FIG. 4**



**FIG. 5**



**FIG. 7**

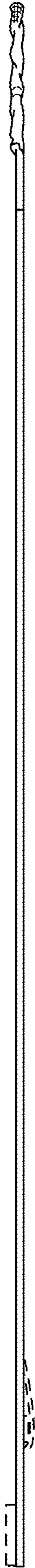


**FIG. 6**

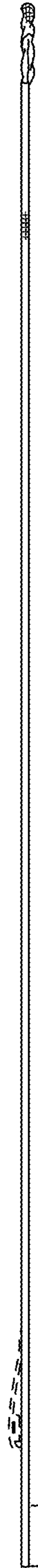




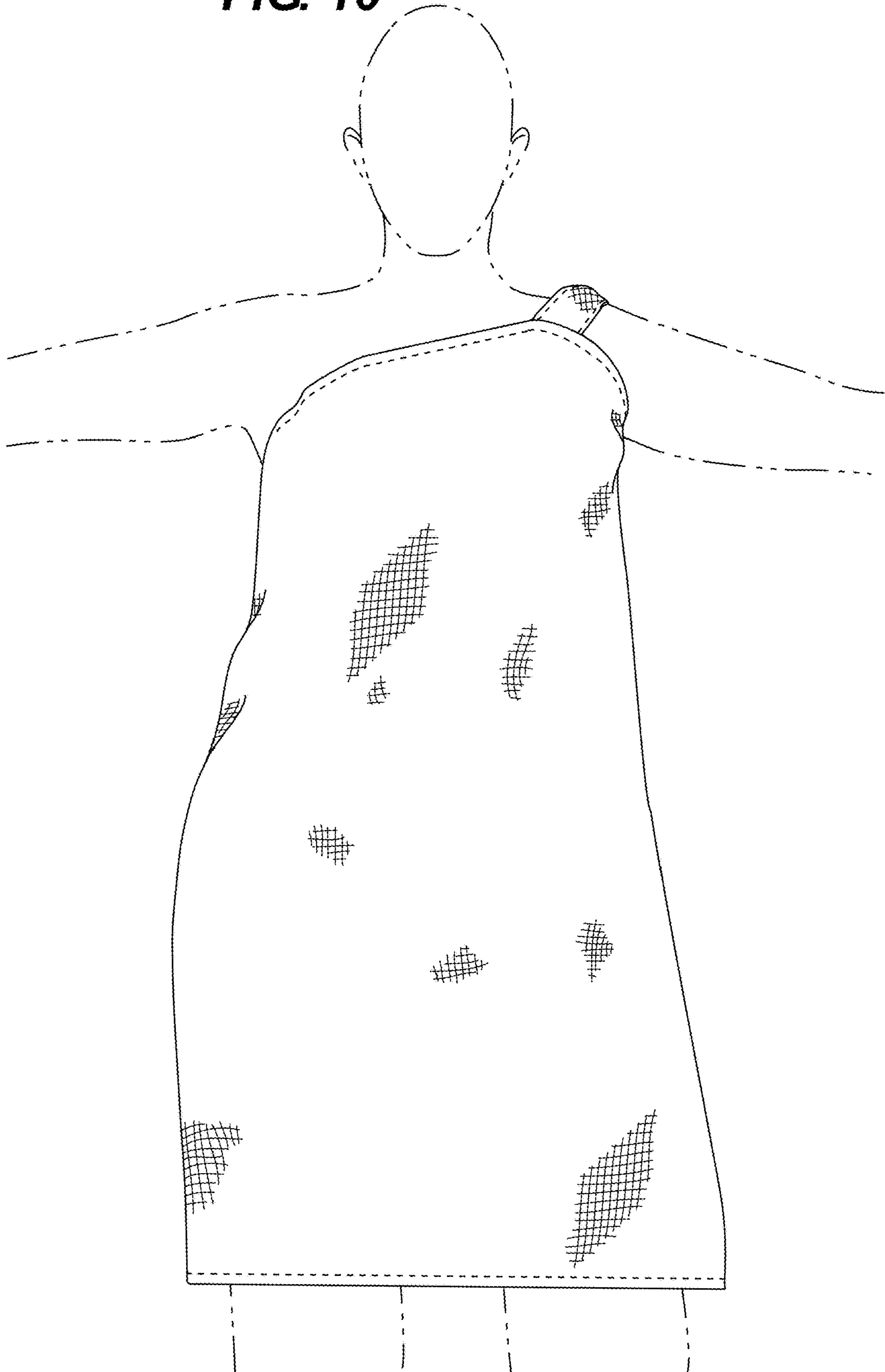
**FIG. 8**



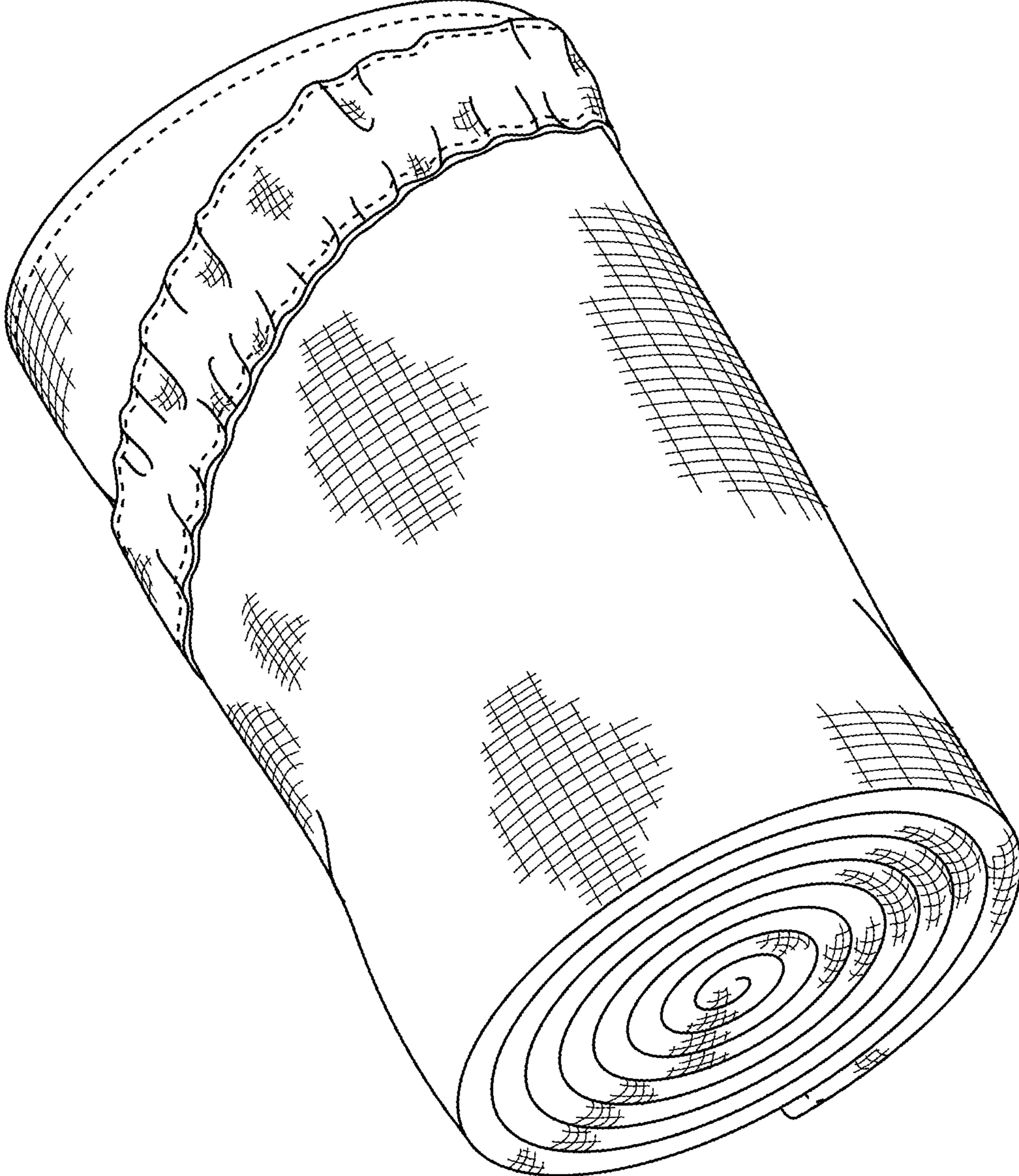
**FIG. 9**



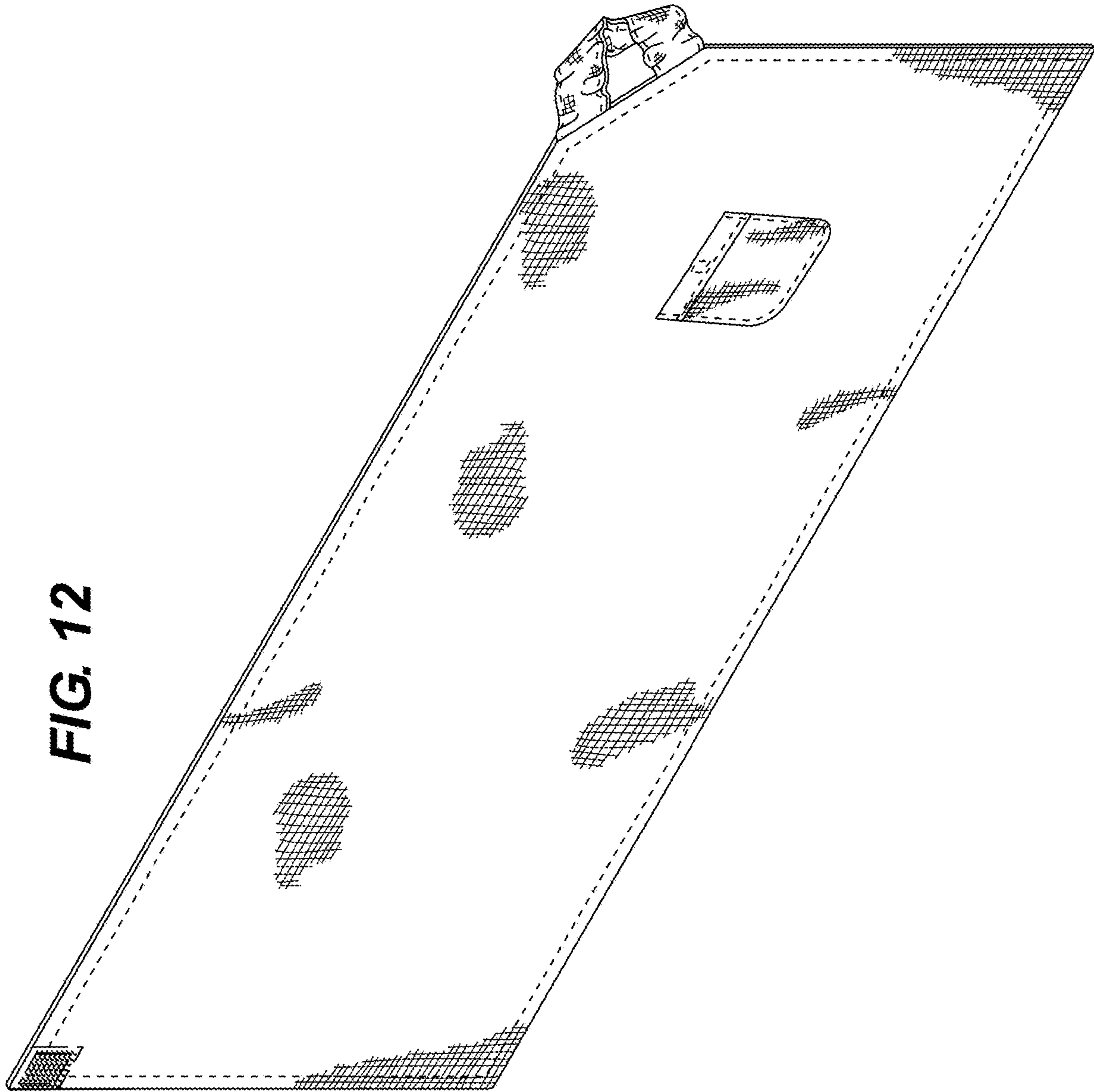
**FIG. 10**



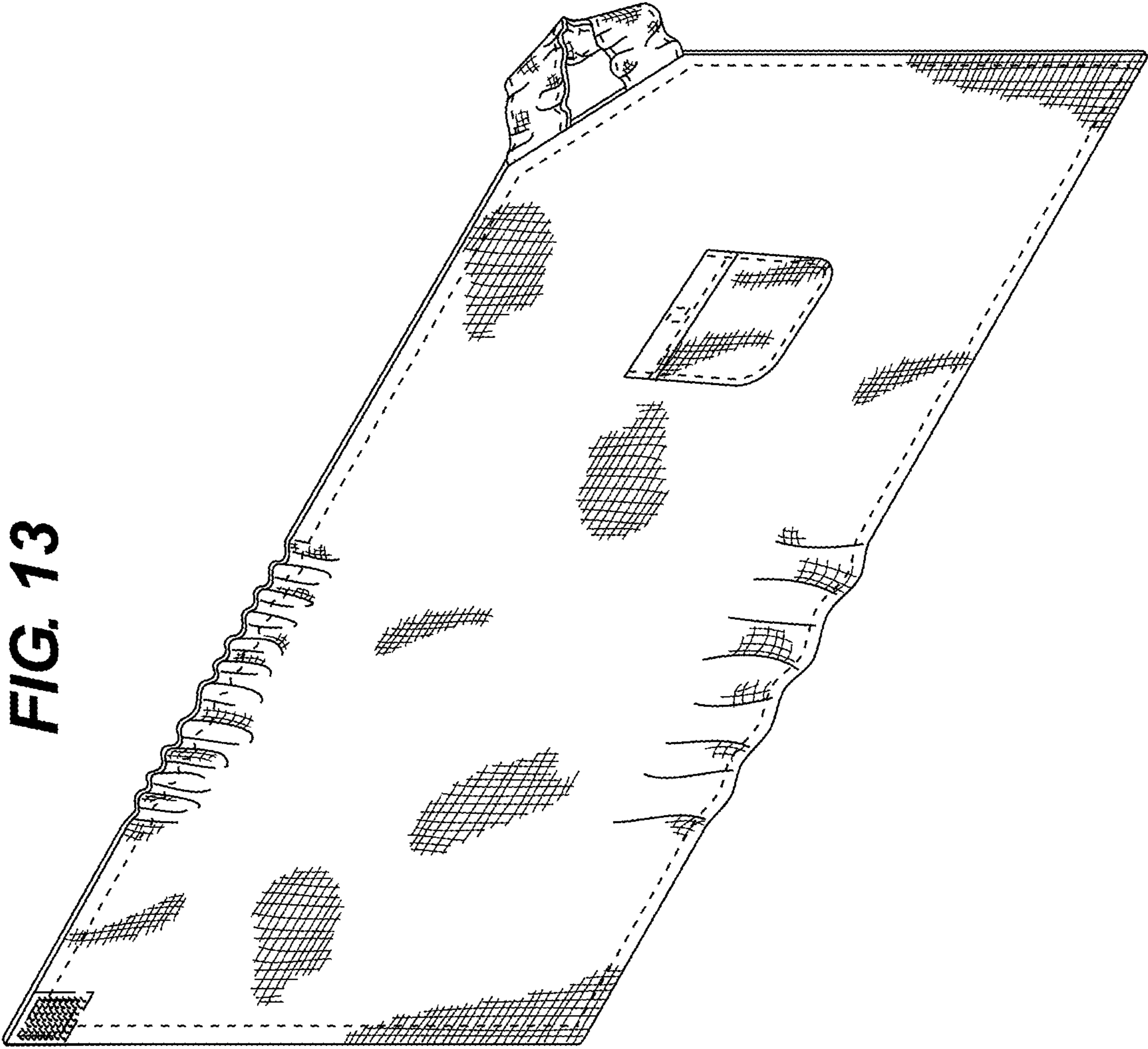
**FIG. 11**

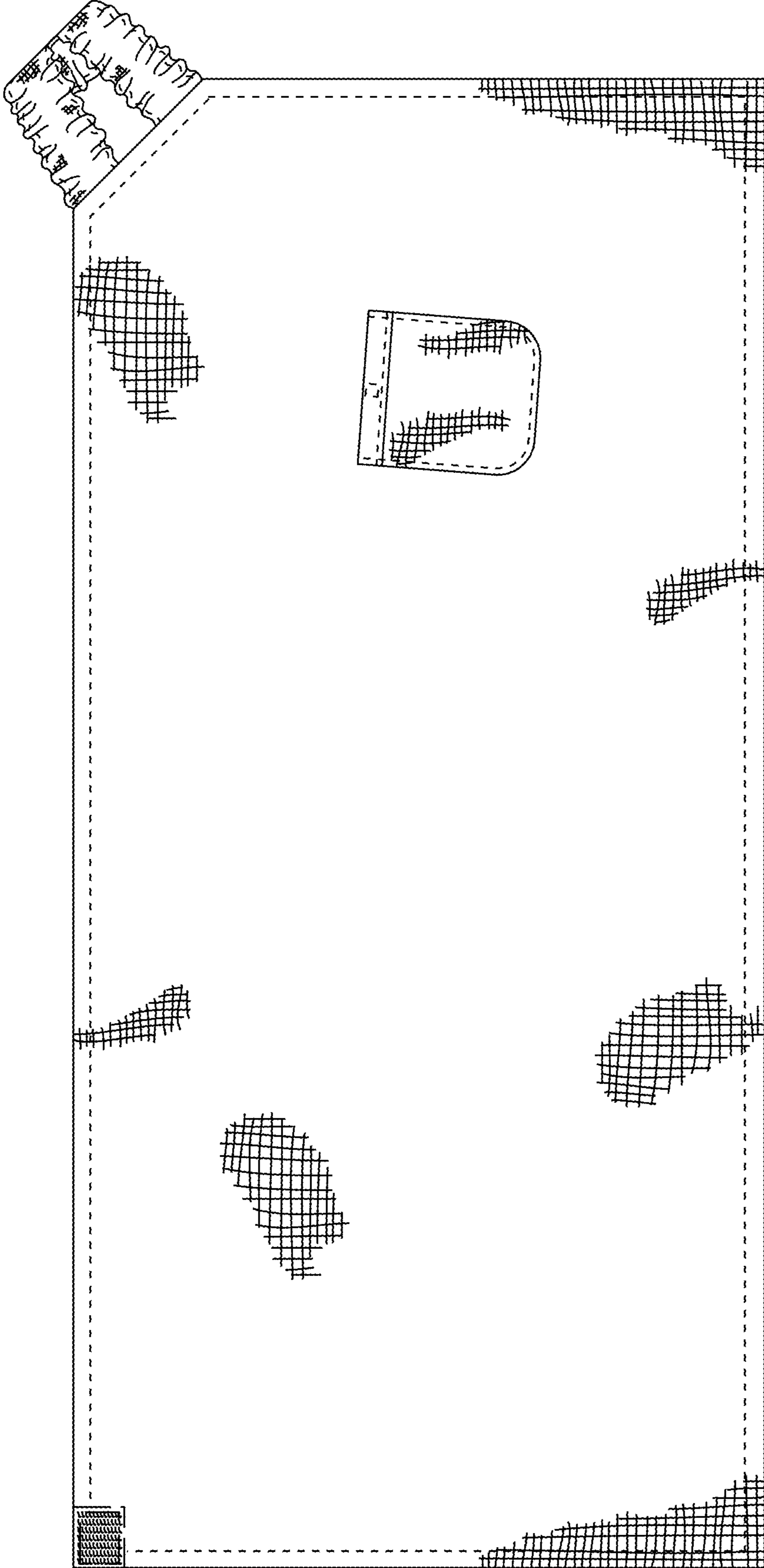


**FIG. 12**



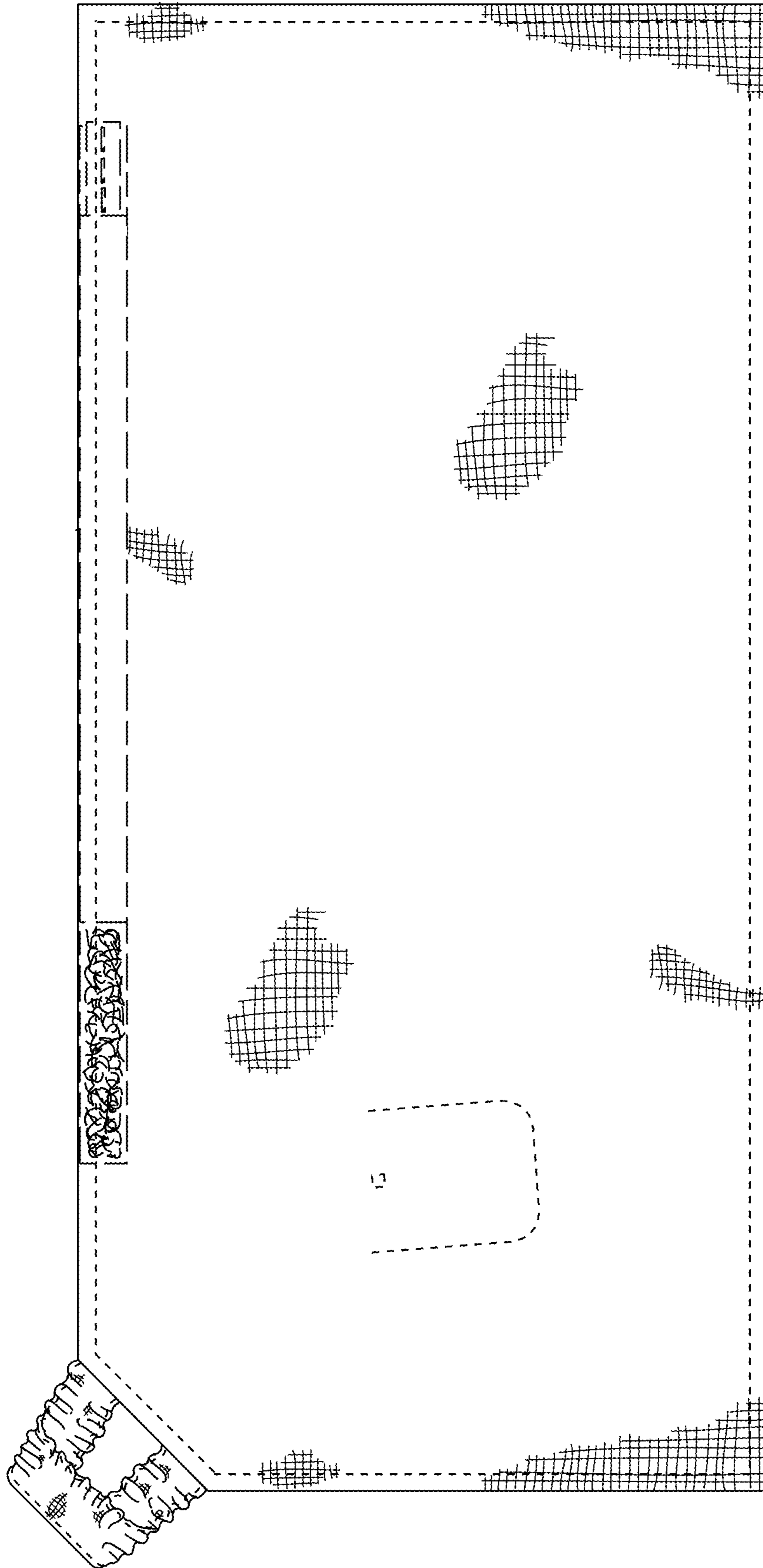
**FIG. 13**



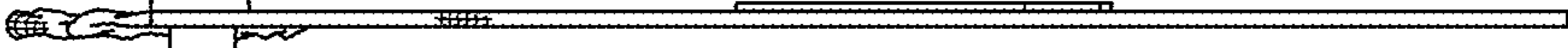


**FIG. 14**

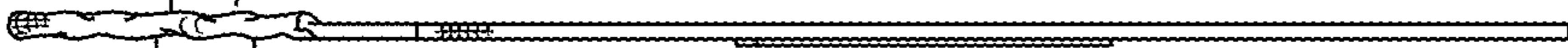
**FIG. 15**



**FIG. 17**

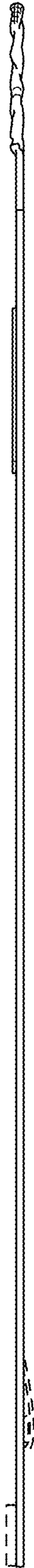


**FIG. 16**

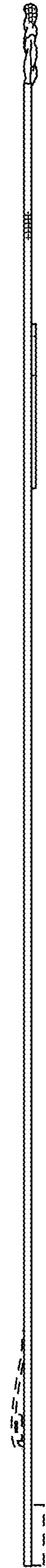




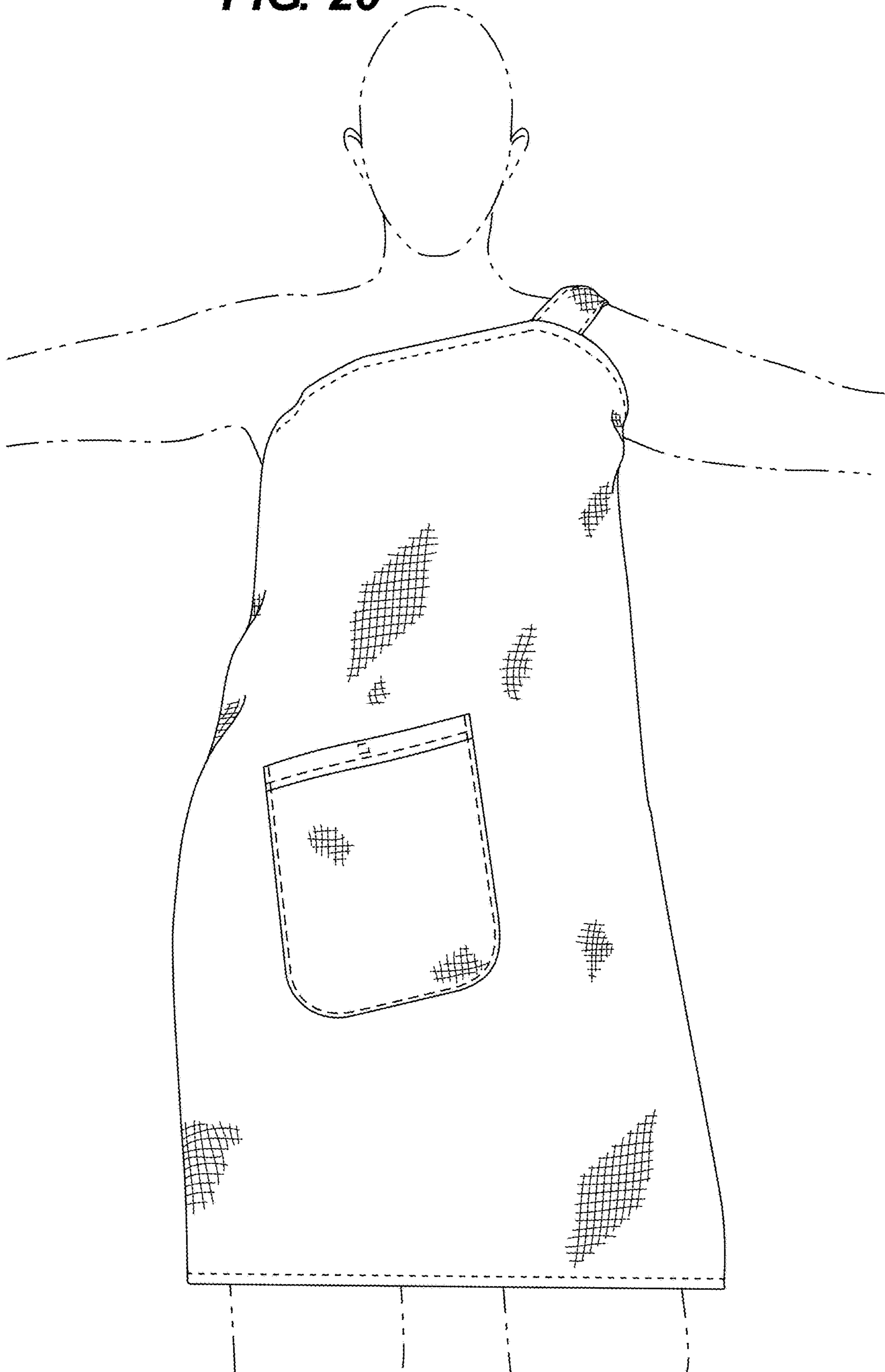
**FIG. 18**



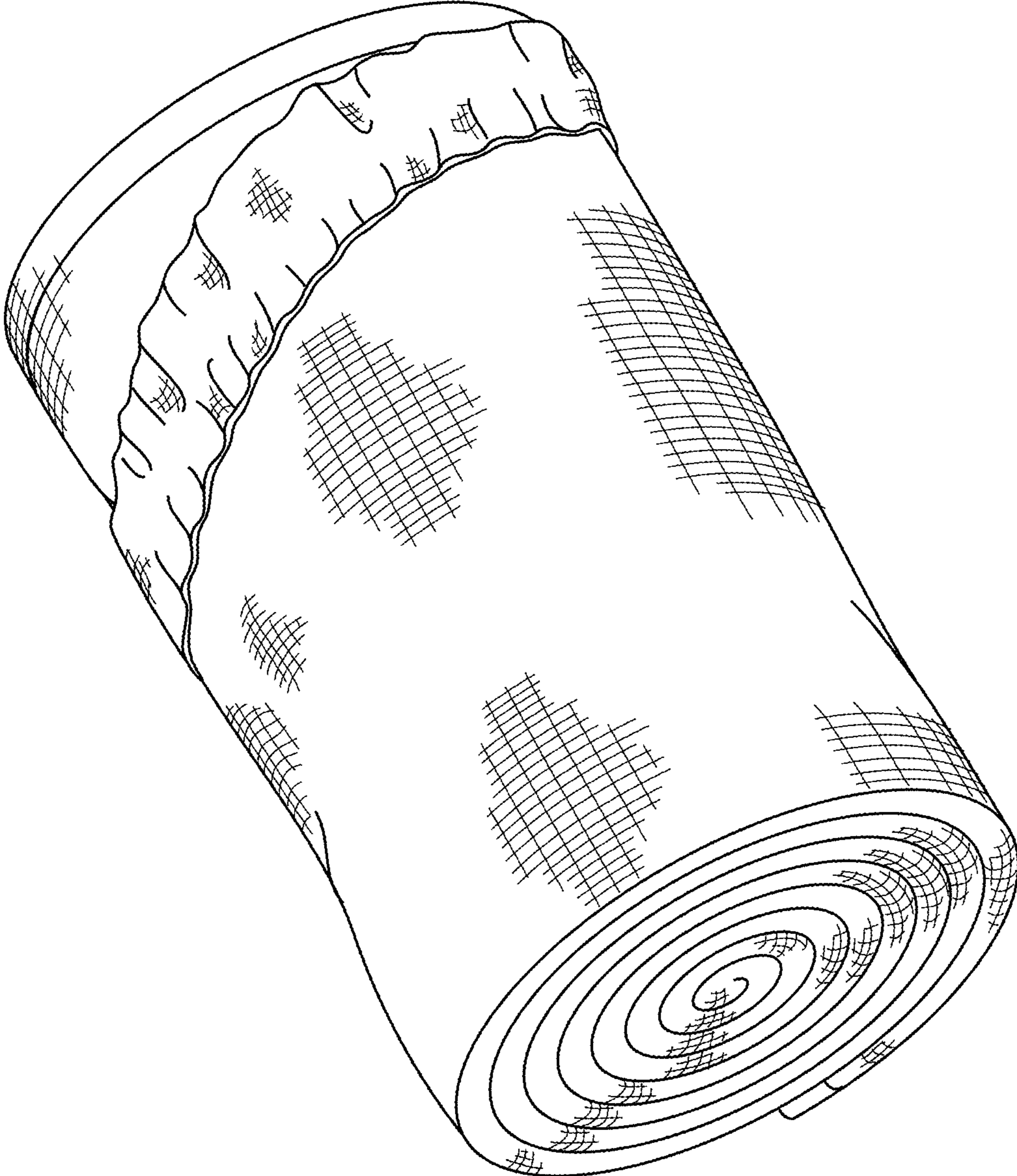
**FIG. 19**



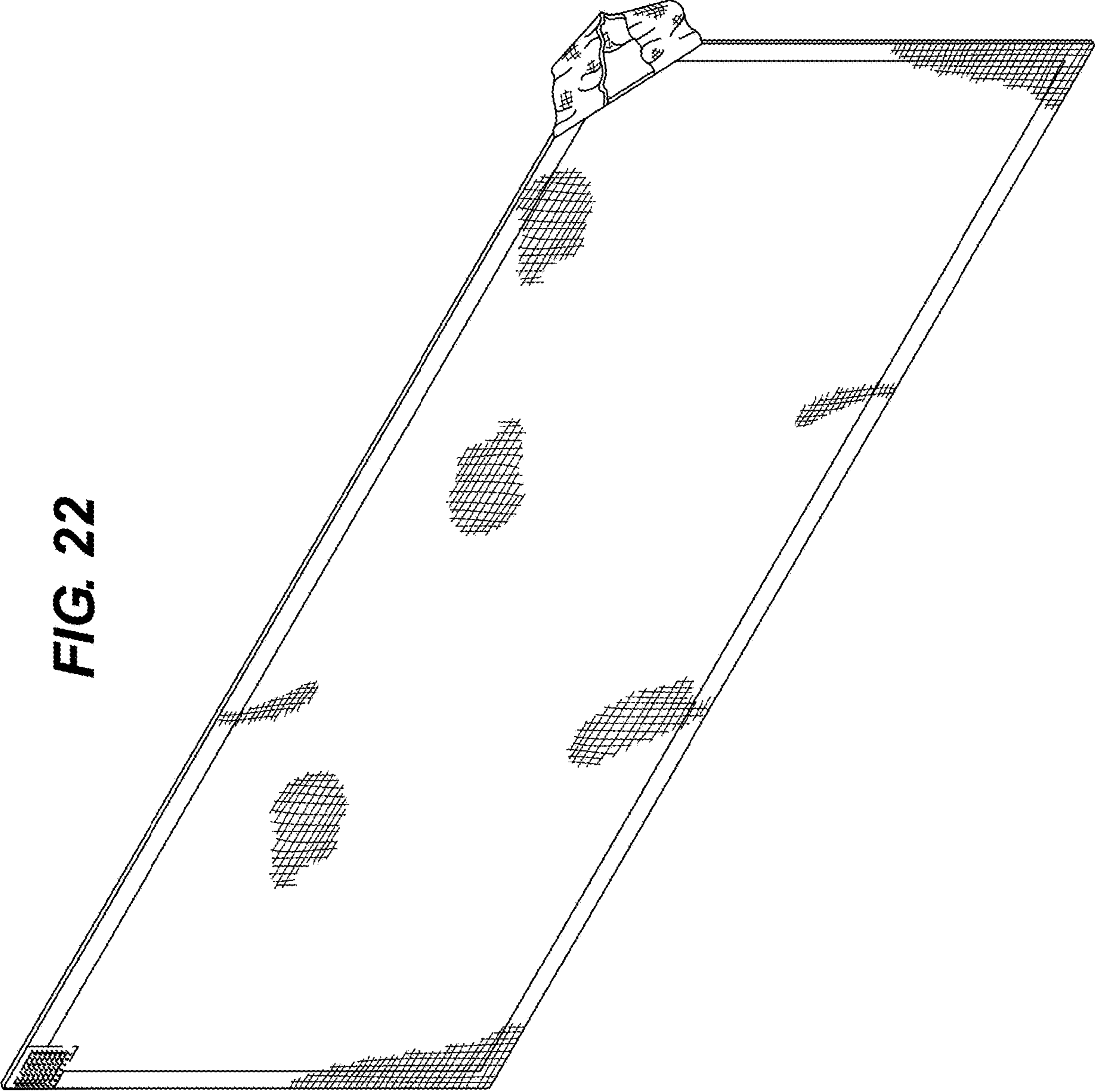
**FIG. 20**

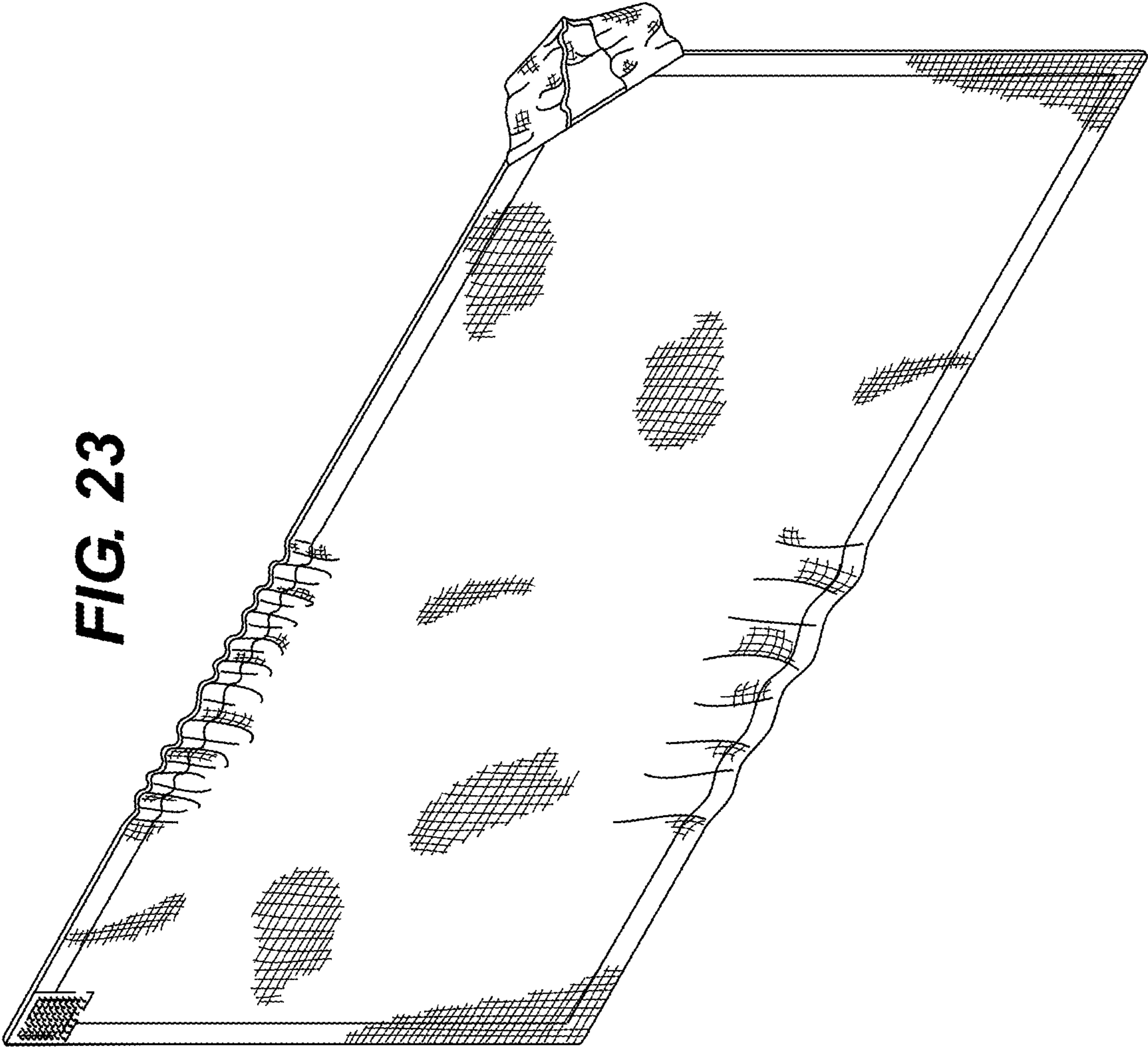


**FIG. 21**



**FIG. 22**



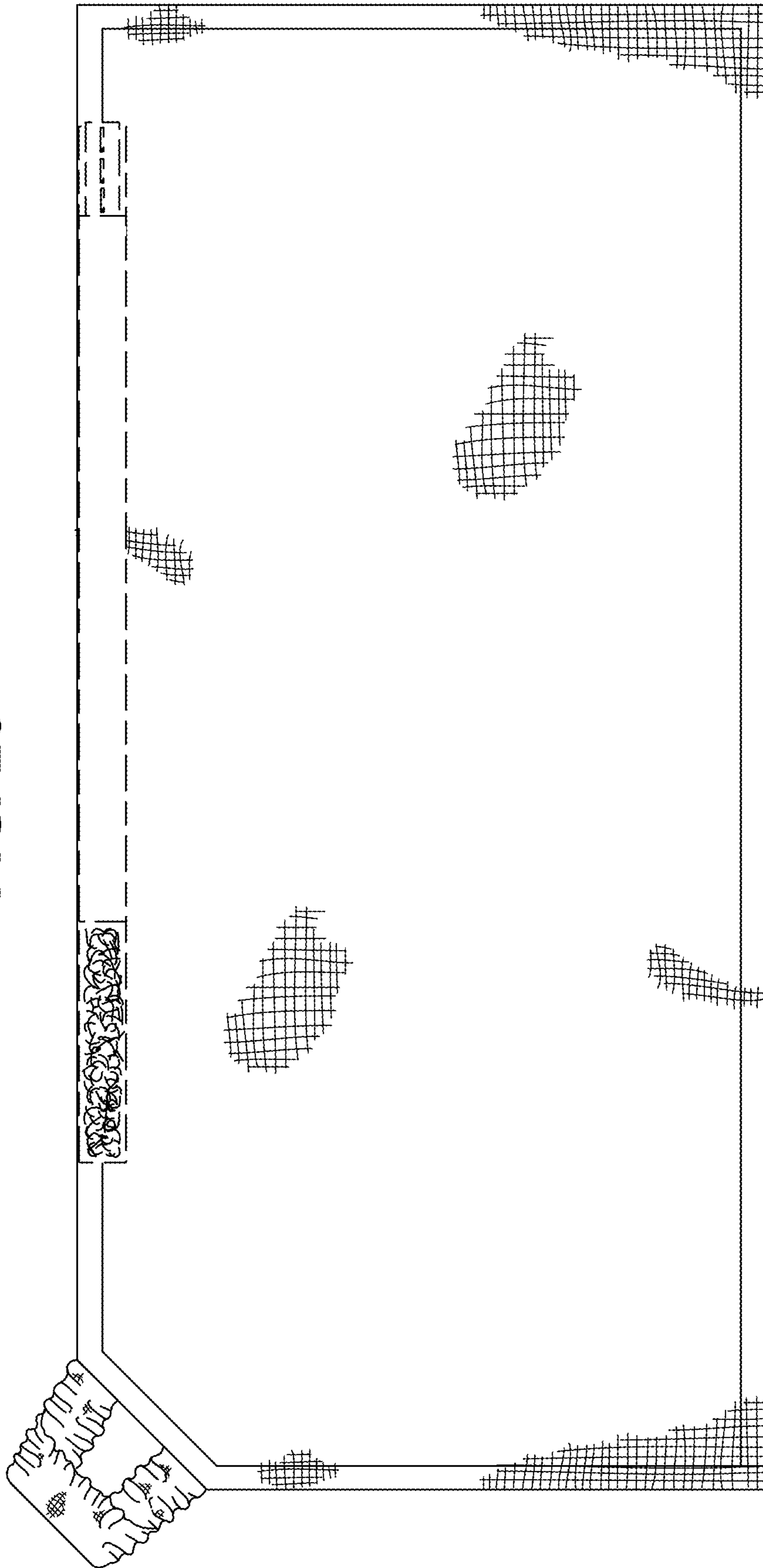


**FIG. 23**

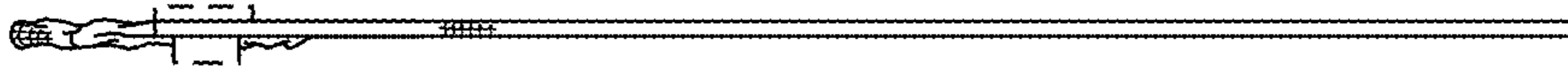


**FIG. 24**

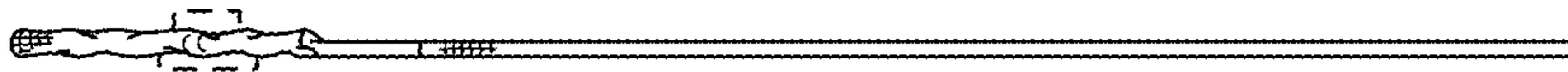
**FIG. 25**



**FIG. 27**



**FIG. 26**

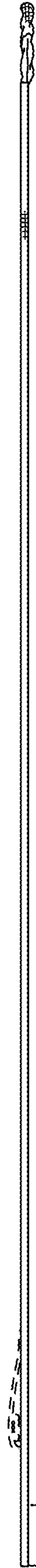




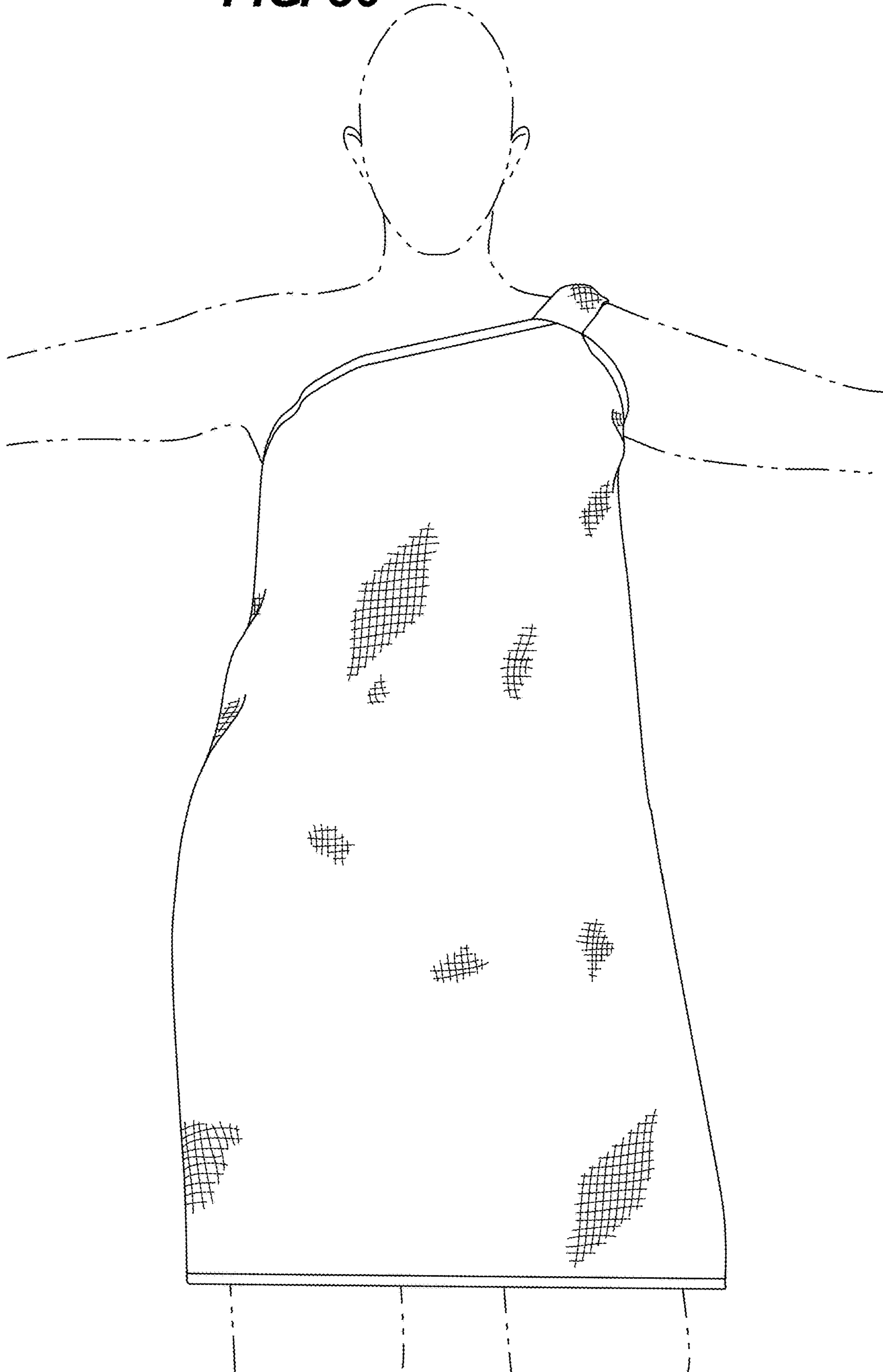
**FIG. 28**



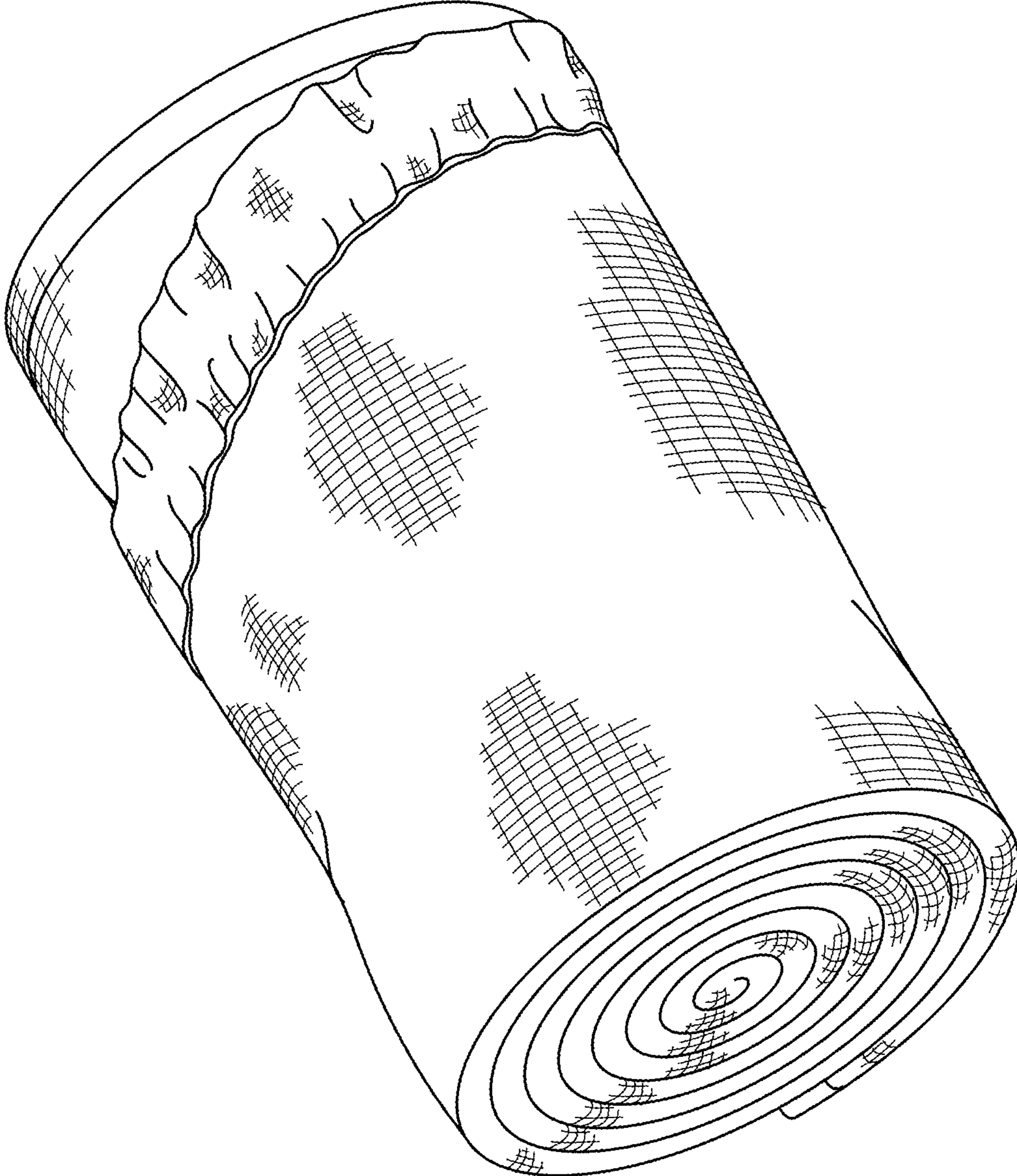
**FIG. 29**



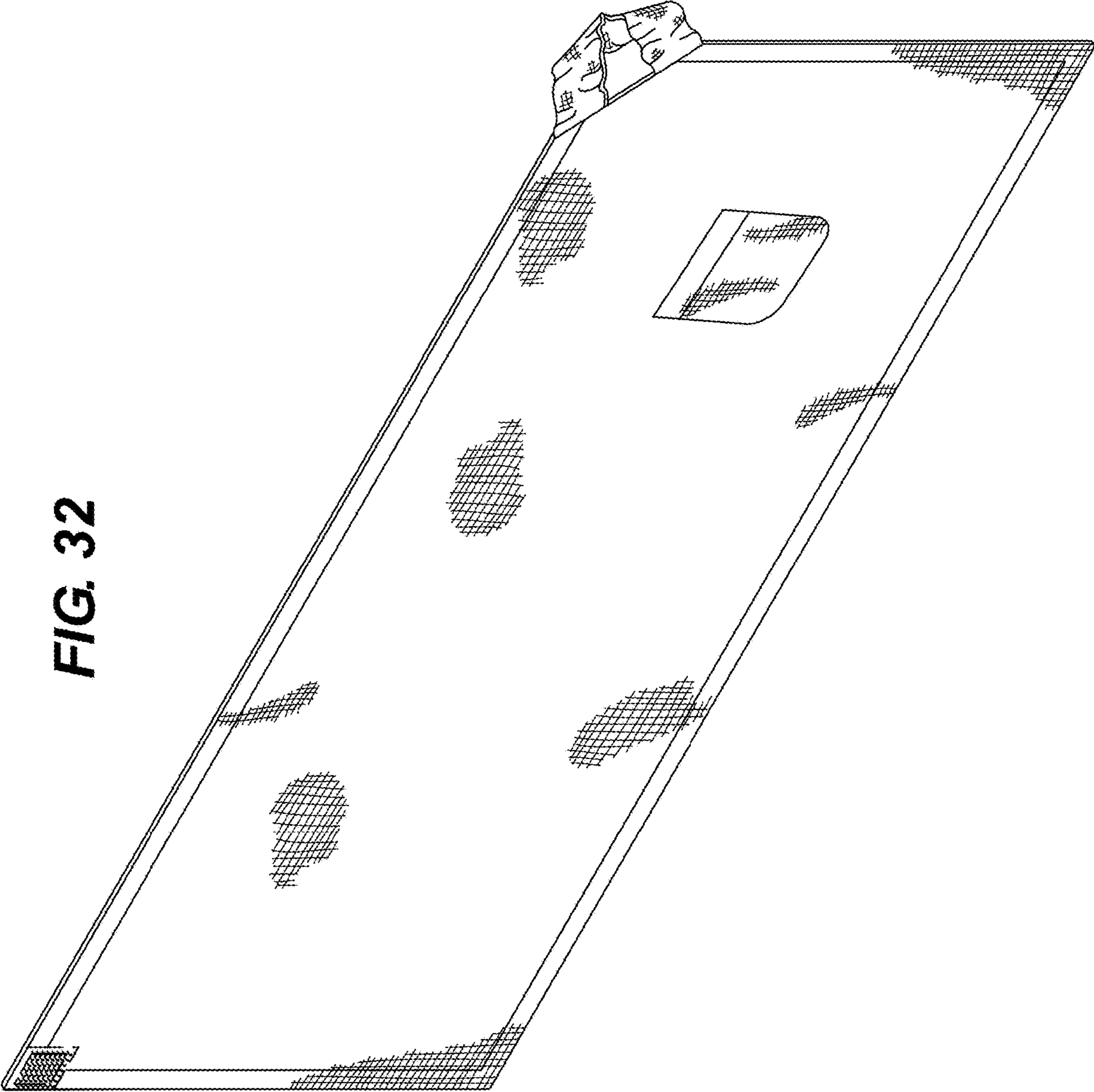
**FIG. 30**



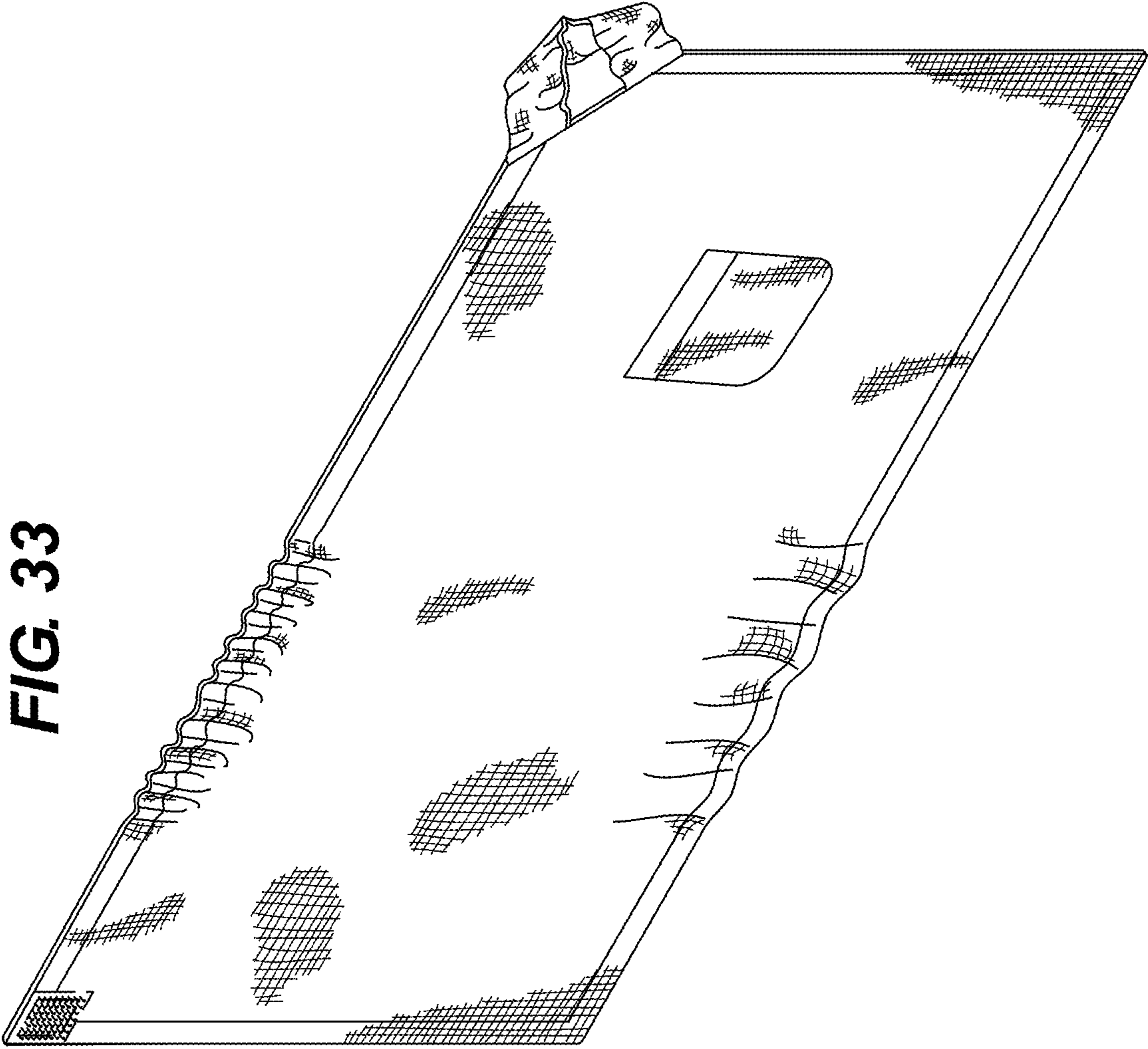
**FIG. 31**



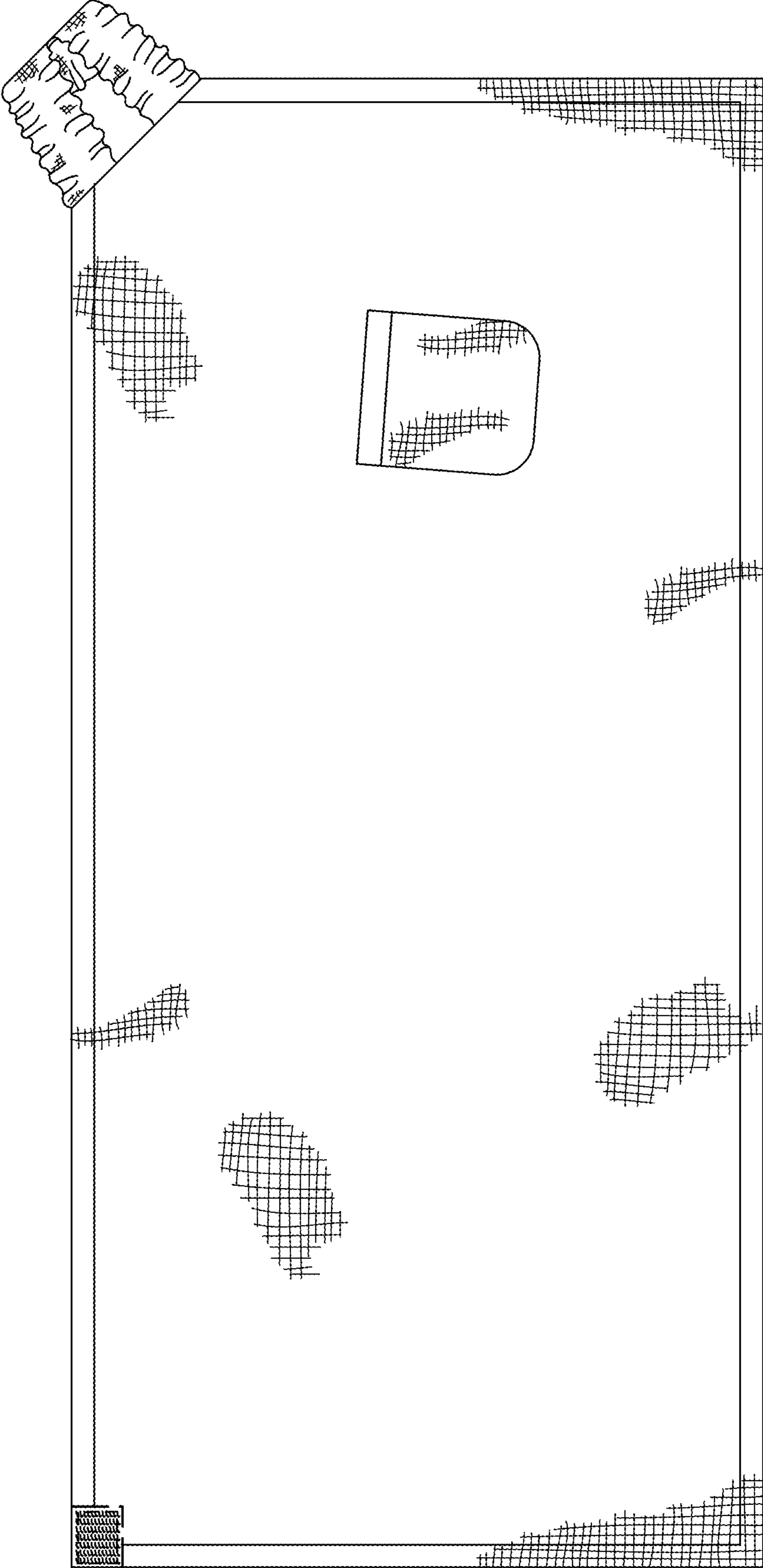
**FIG. 32**



**FIG. 33**



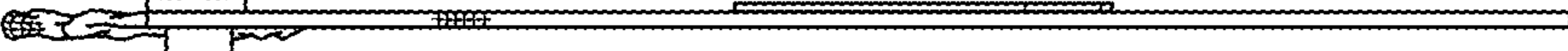
**FIG. 34**



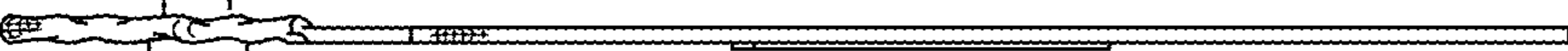
**FIG. 35**



**FIG. 37**

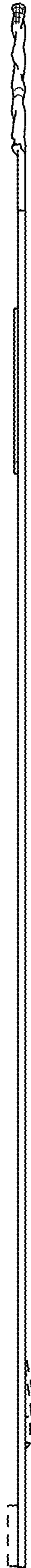


**FIG. 36**

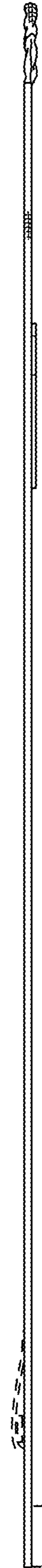




**FIG. 38**



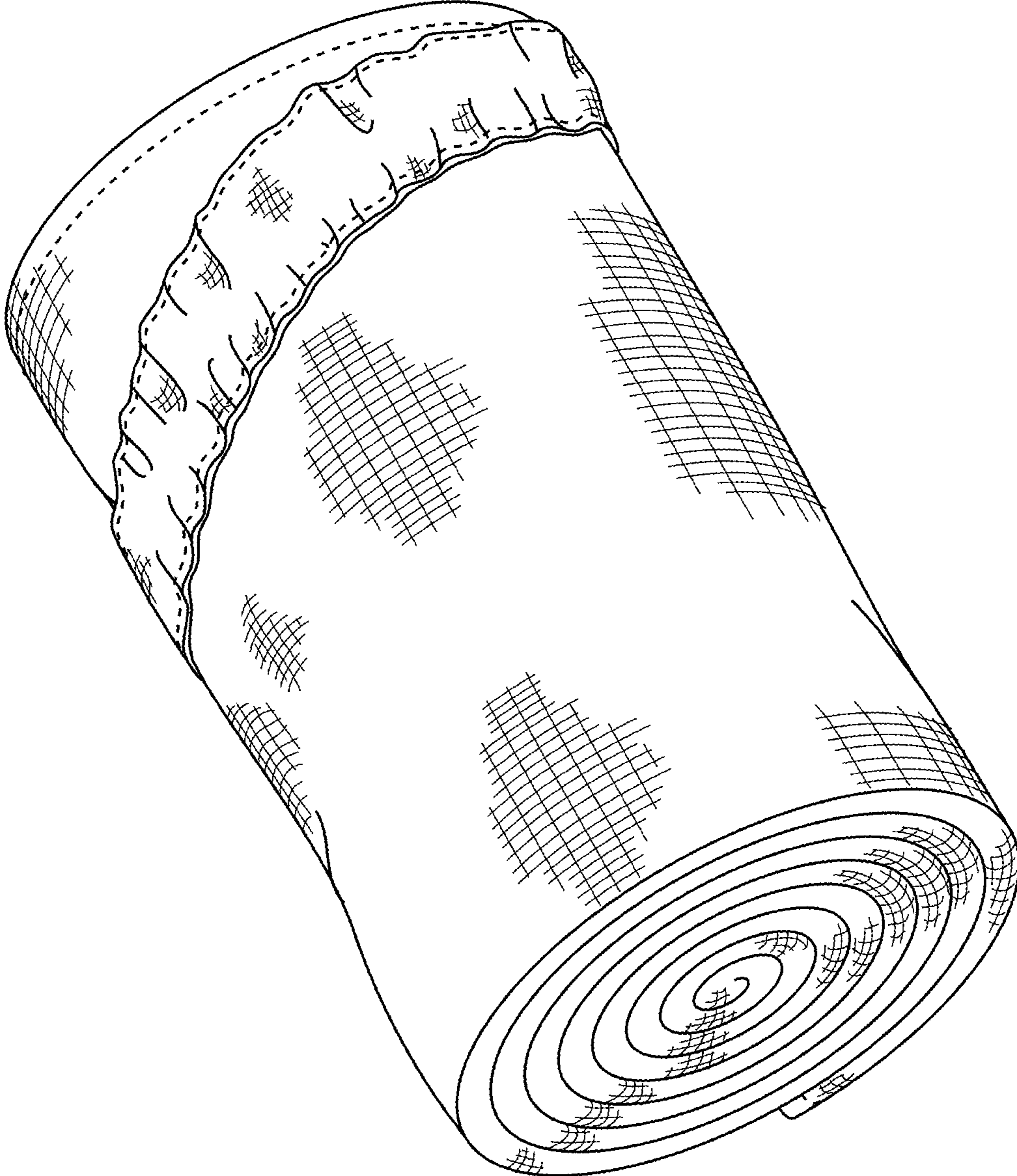
**FIG. 39**

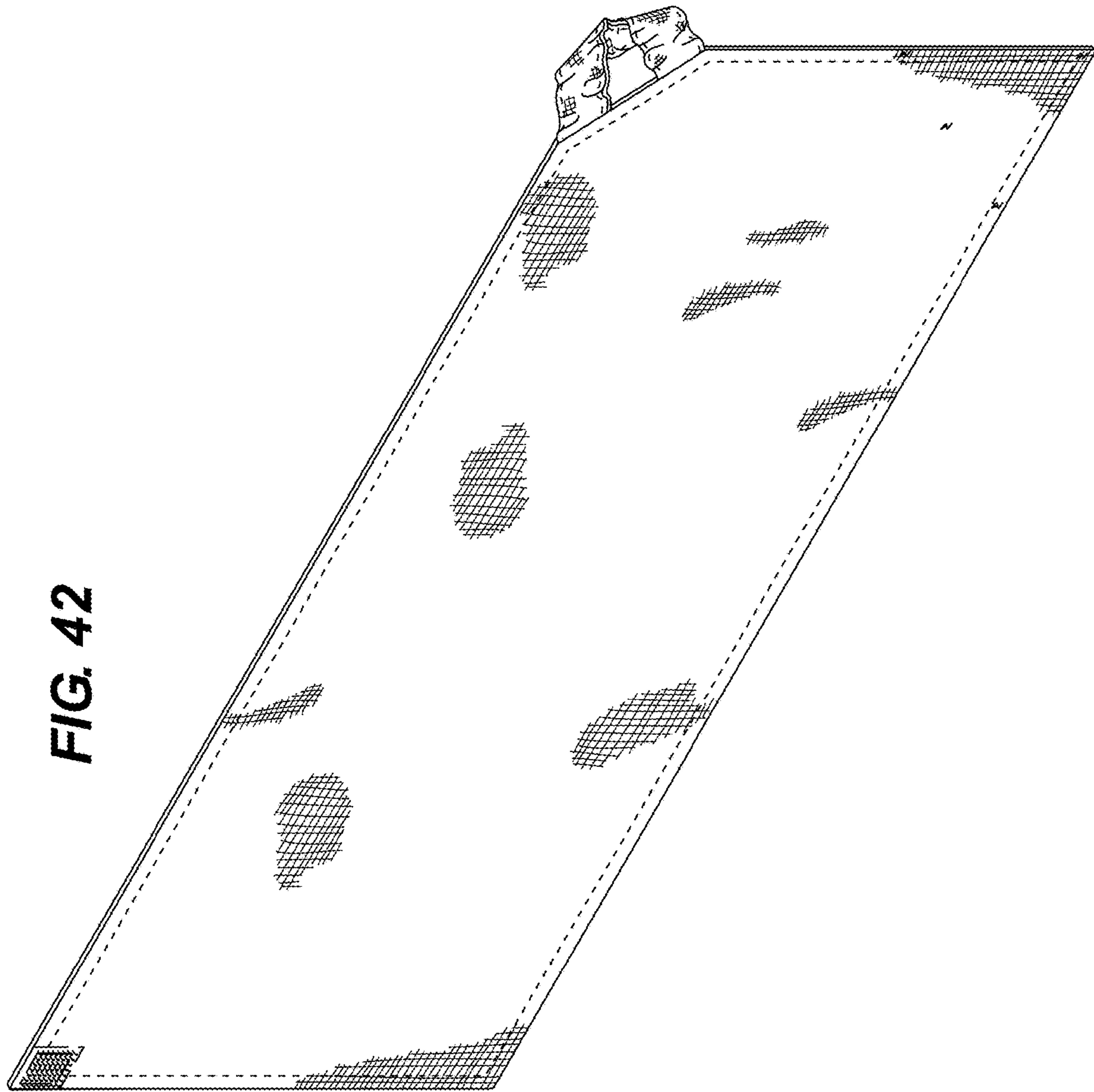


**FIG. 40**

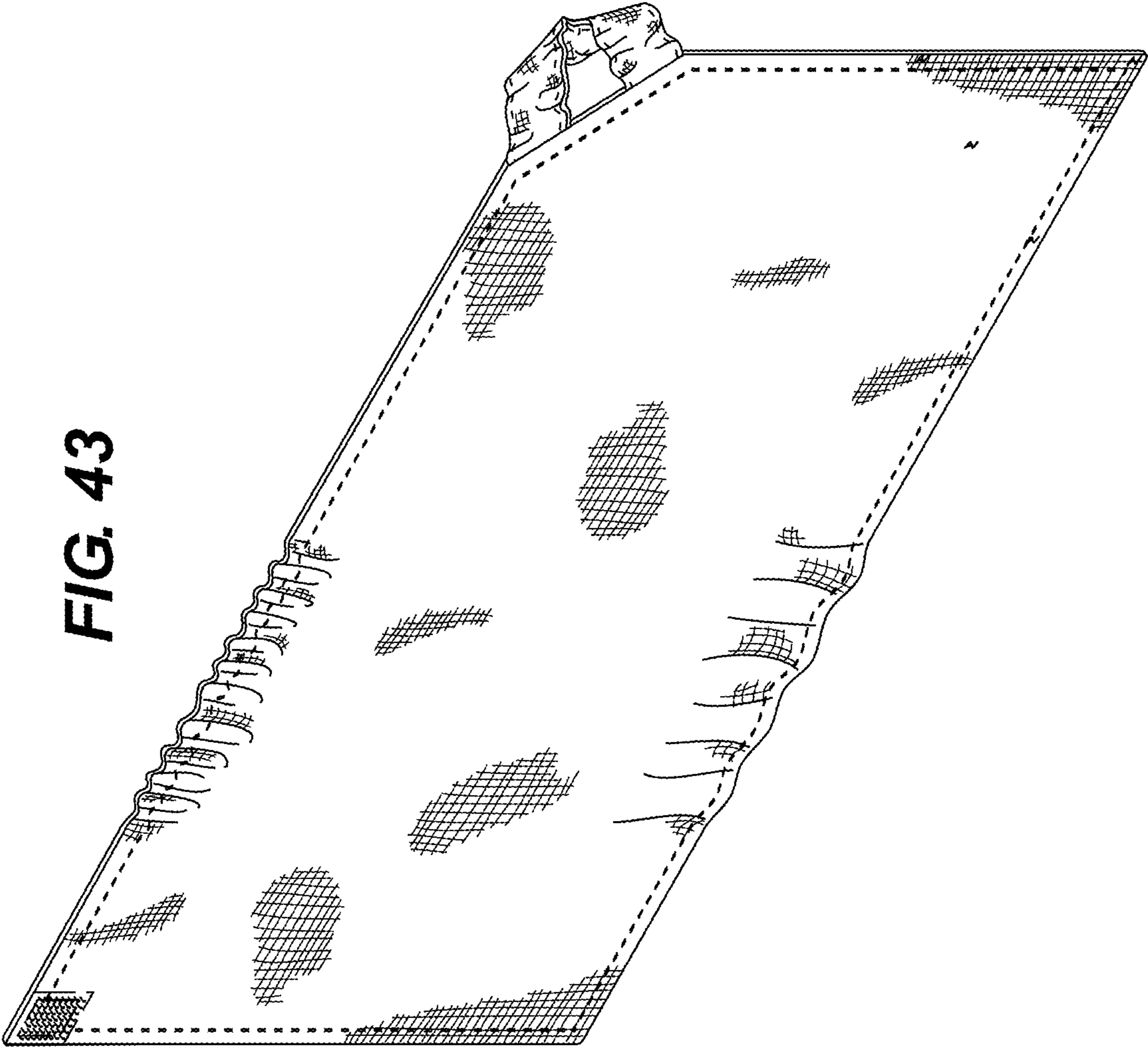


**FIG. 41**



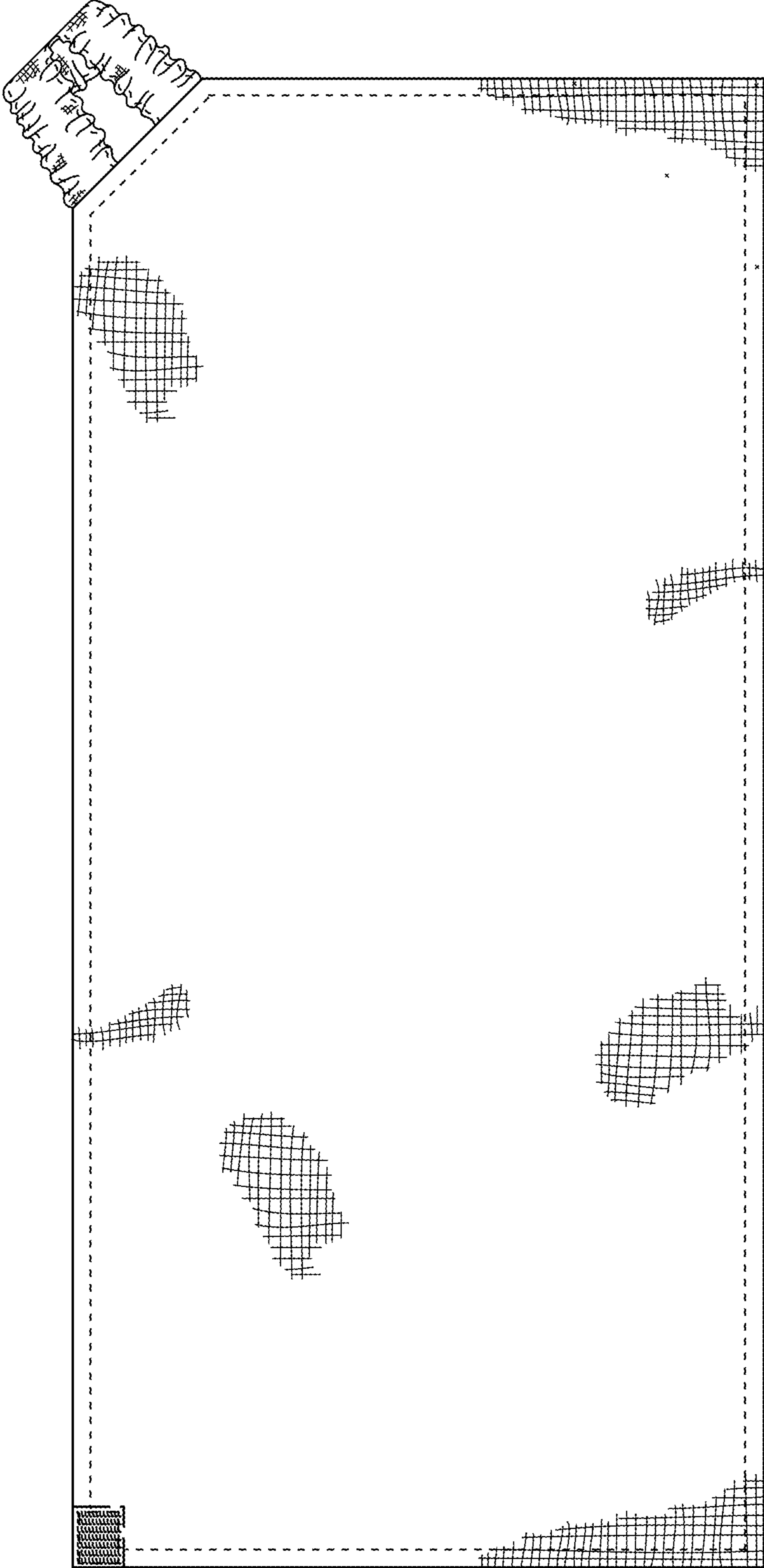


**FIG. 42**

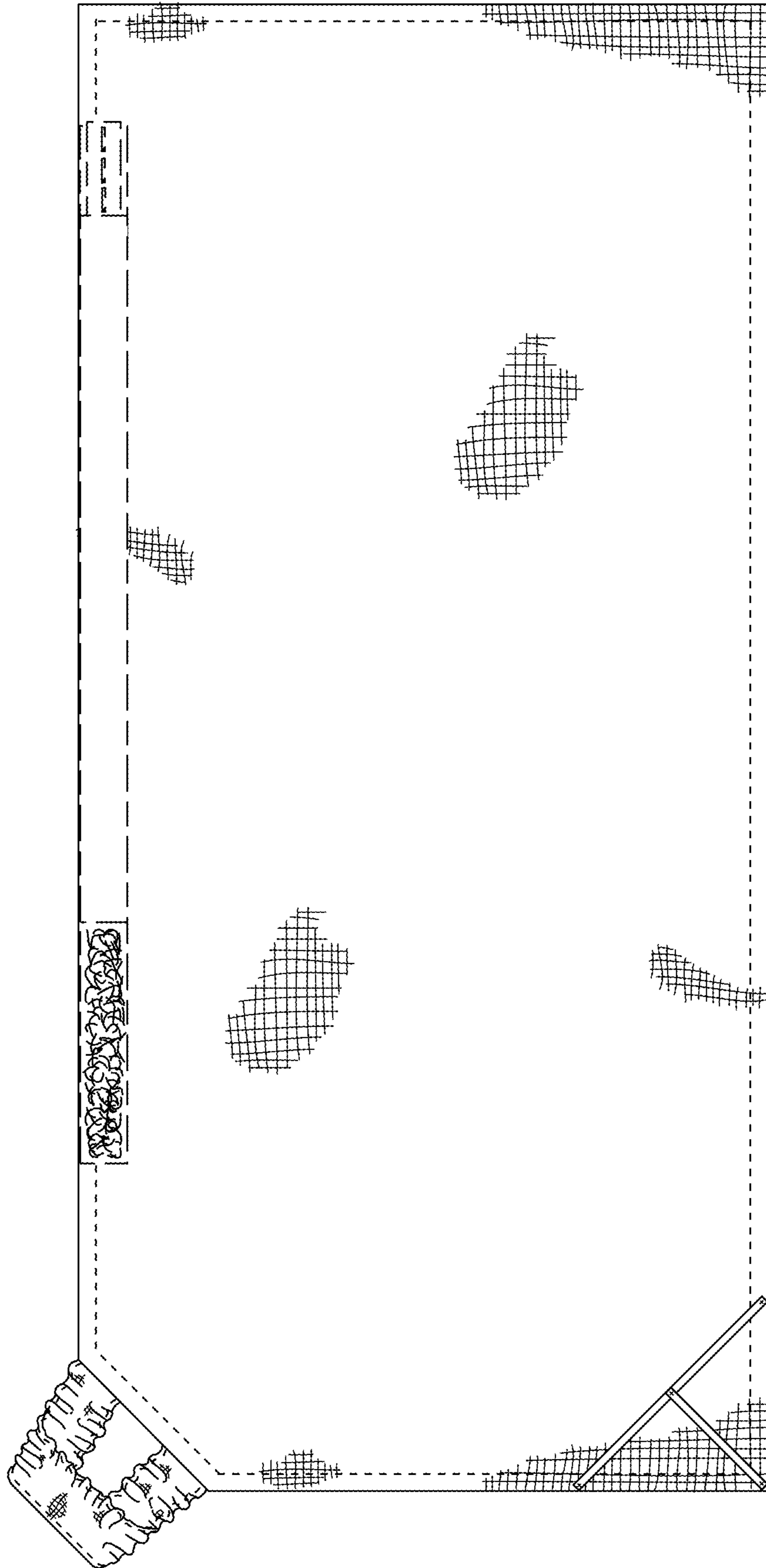


**FIG. 43**

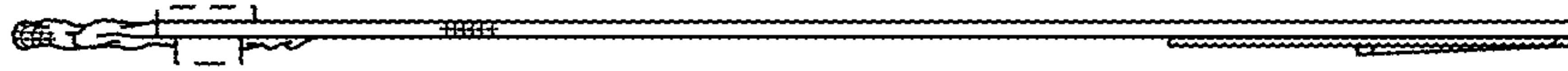
**FIG. 44**



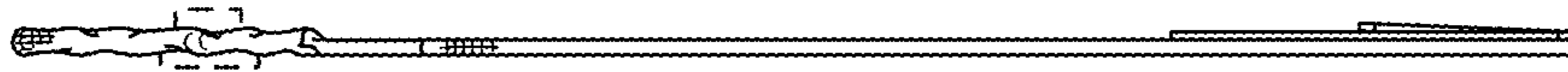
**FIG. 45**



**FIG. 47**

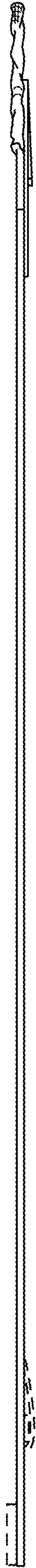


**FIG. 46**





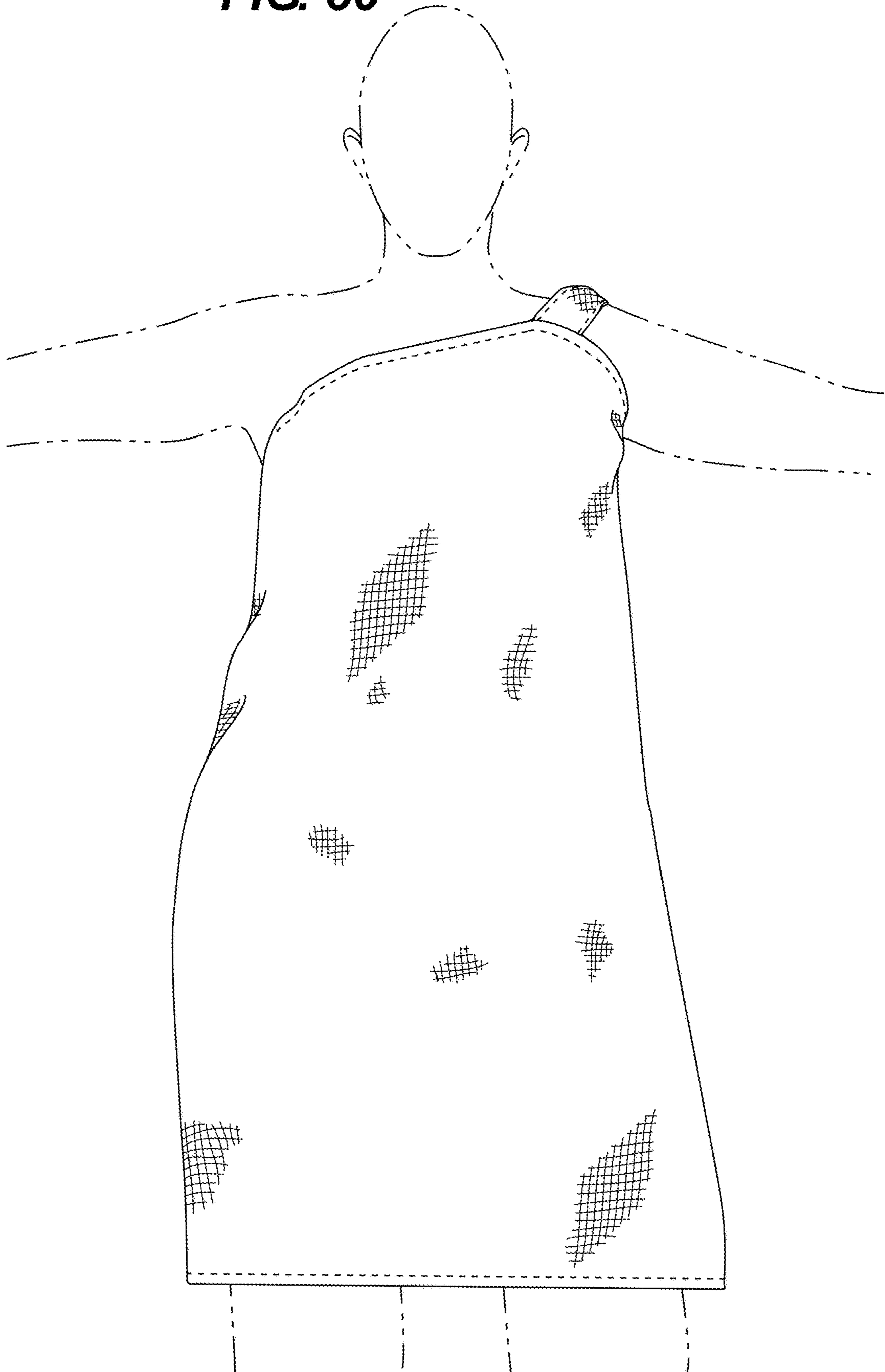
**FIG. 48**



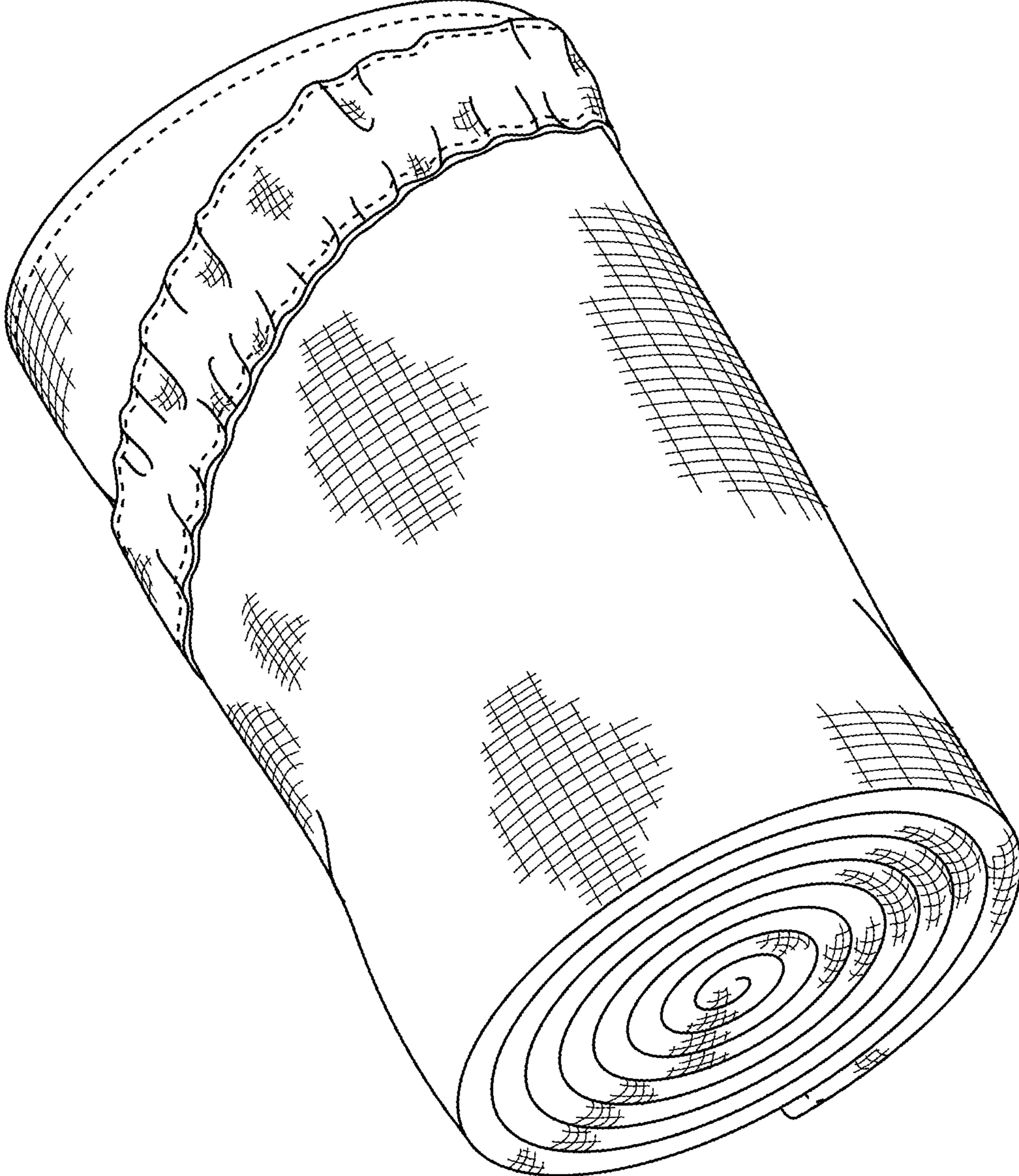
**FIG. 49**

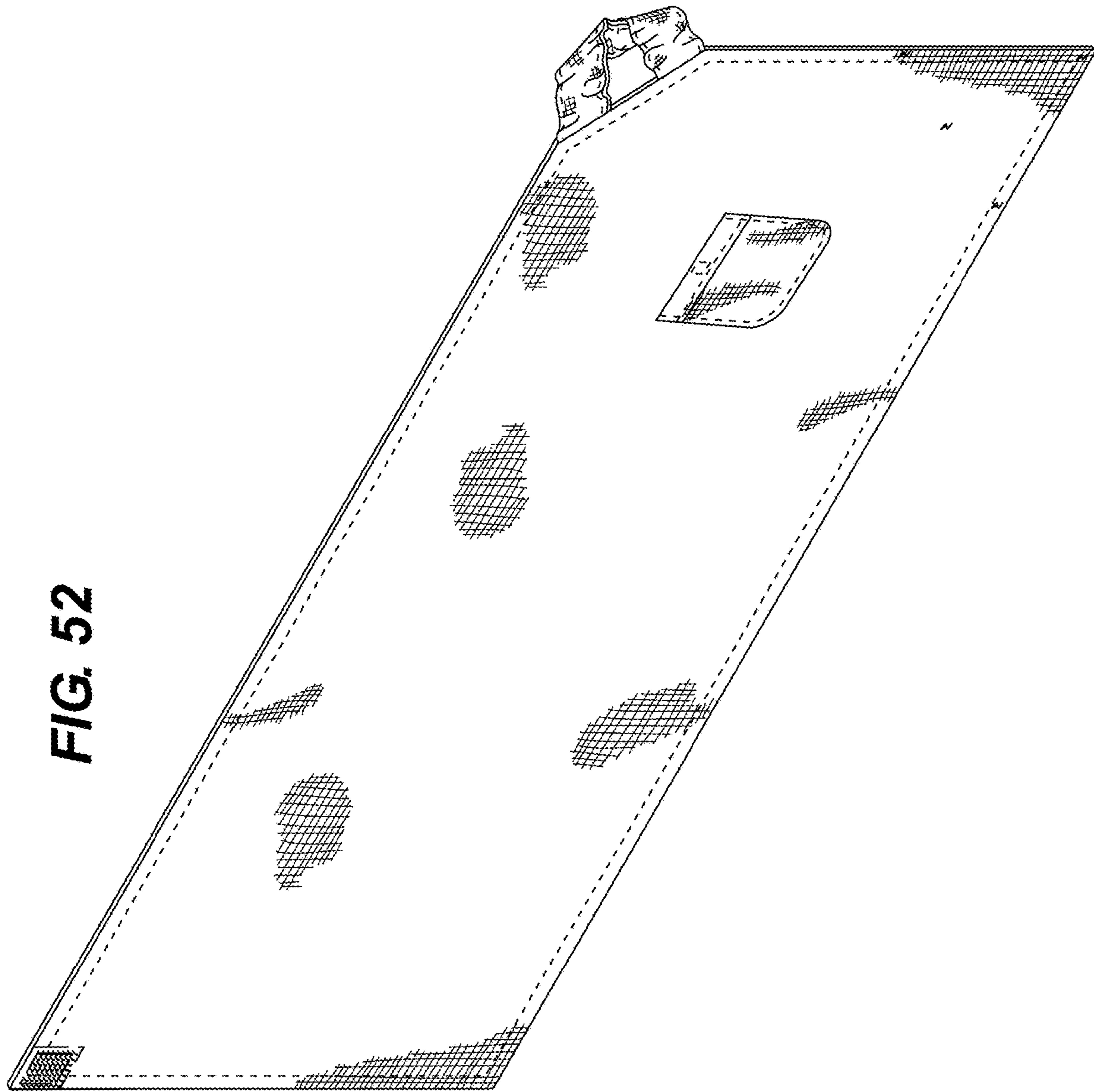


**FIG. 50**

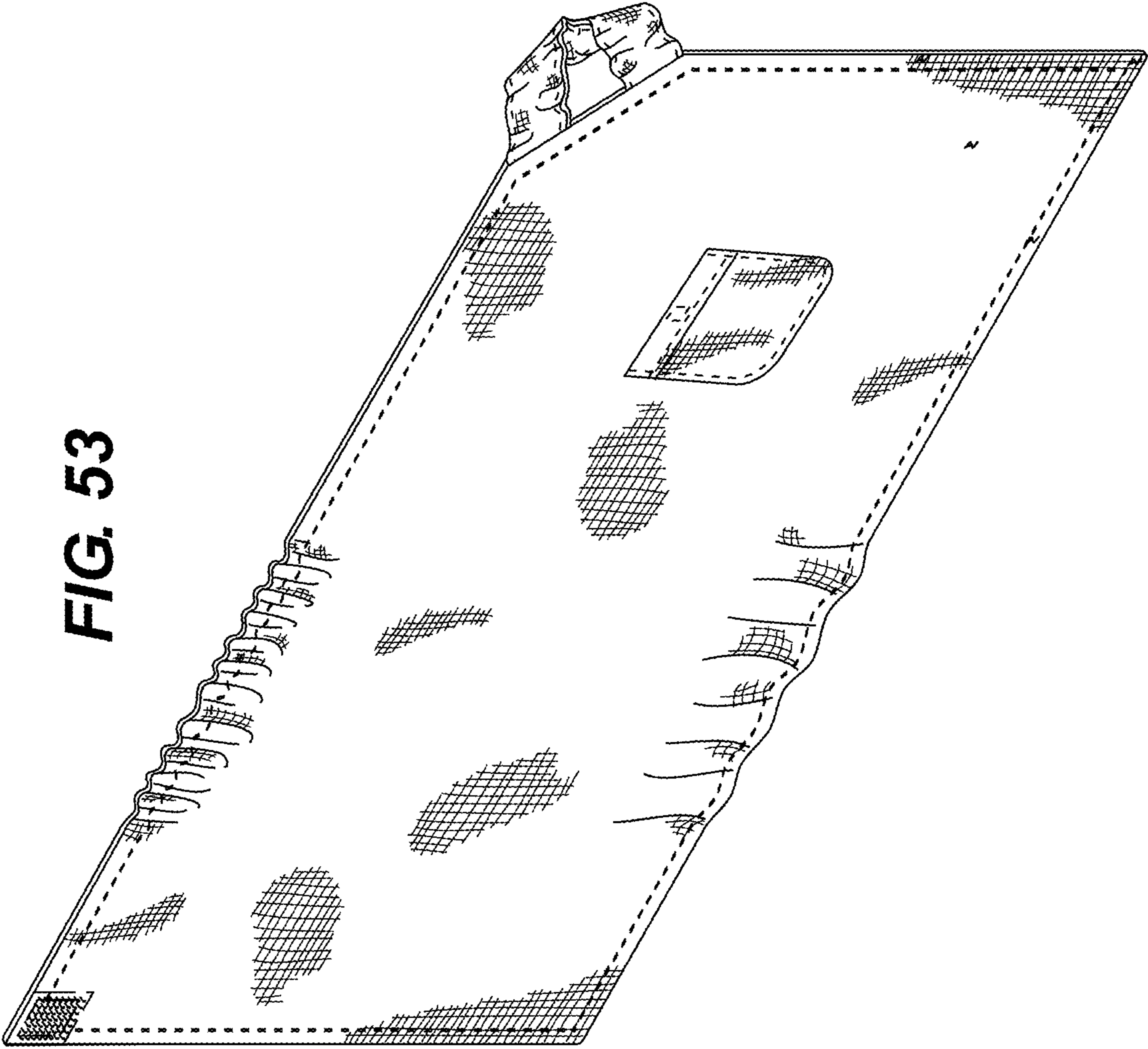


**FIG. 51**



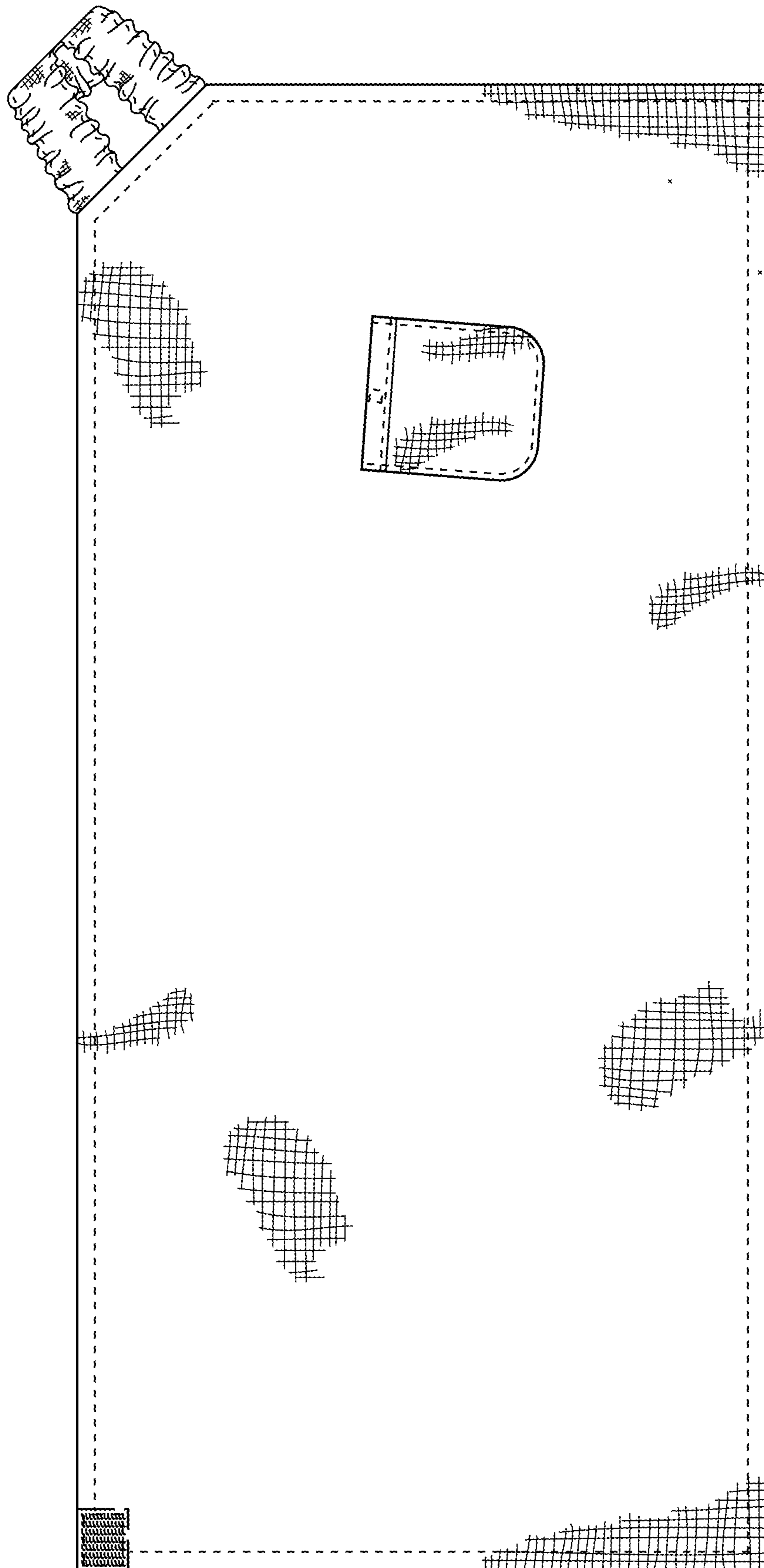


**FIG. 52**

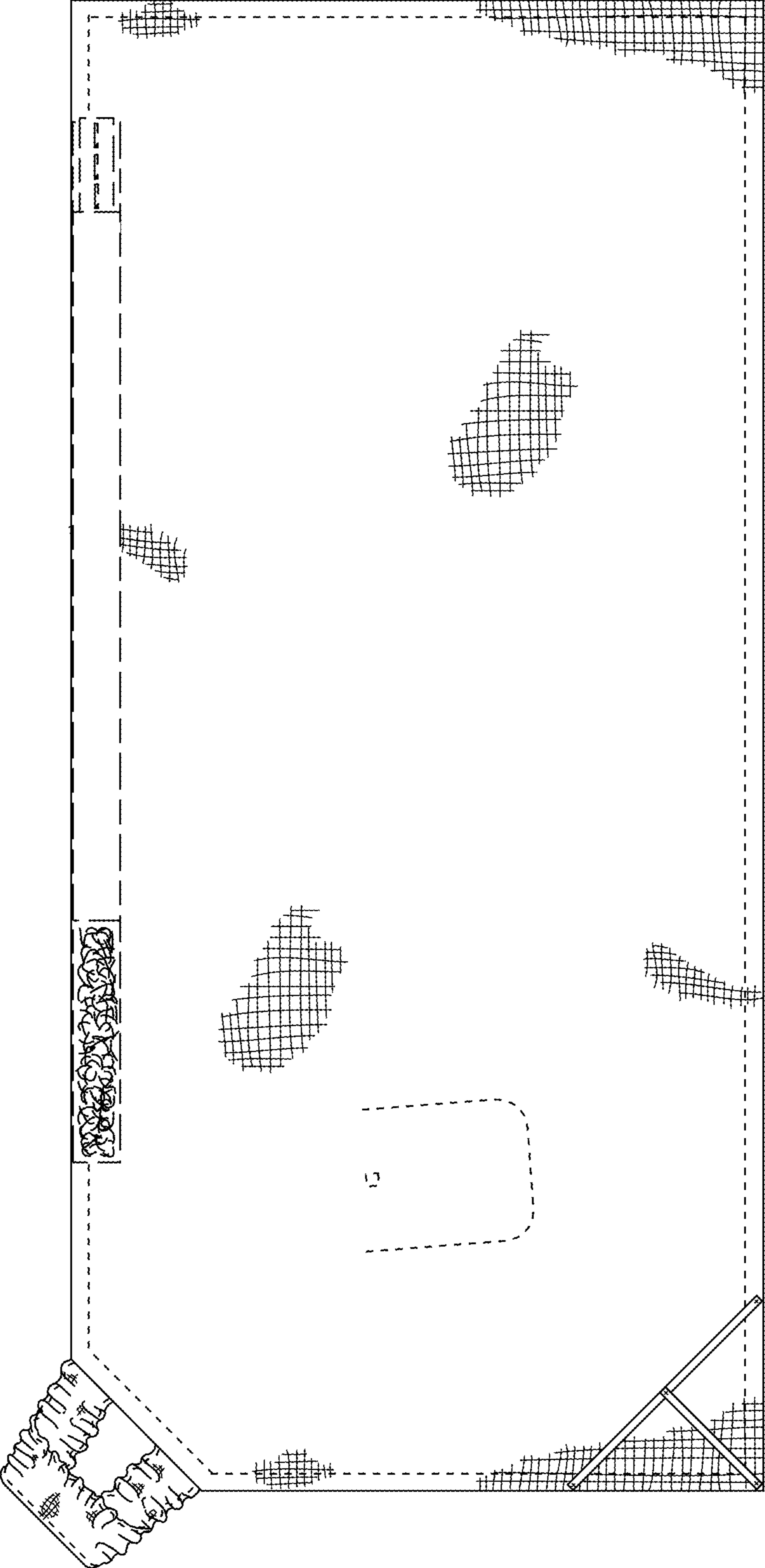


**FIG. 53**

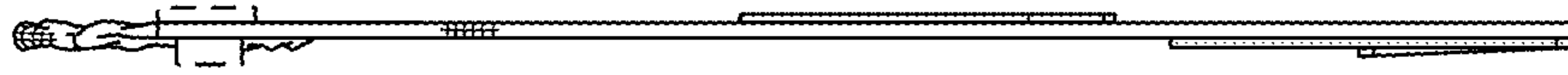
**FIG. 54**



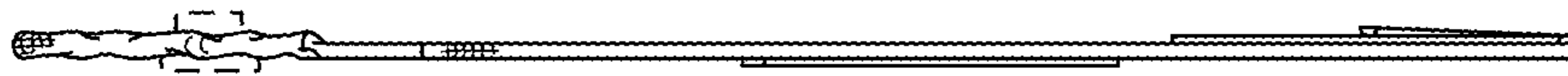
**FIG. 55**



**FIG. 57**

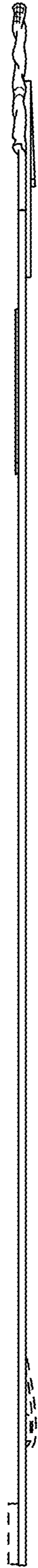


**FIG. 56**

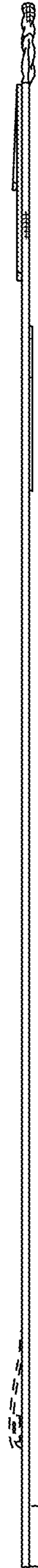




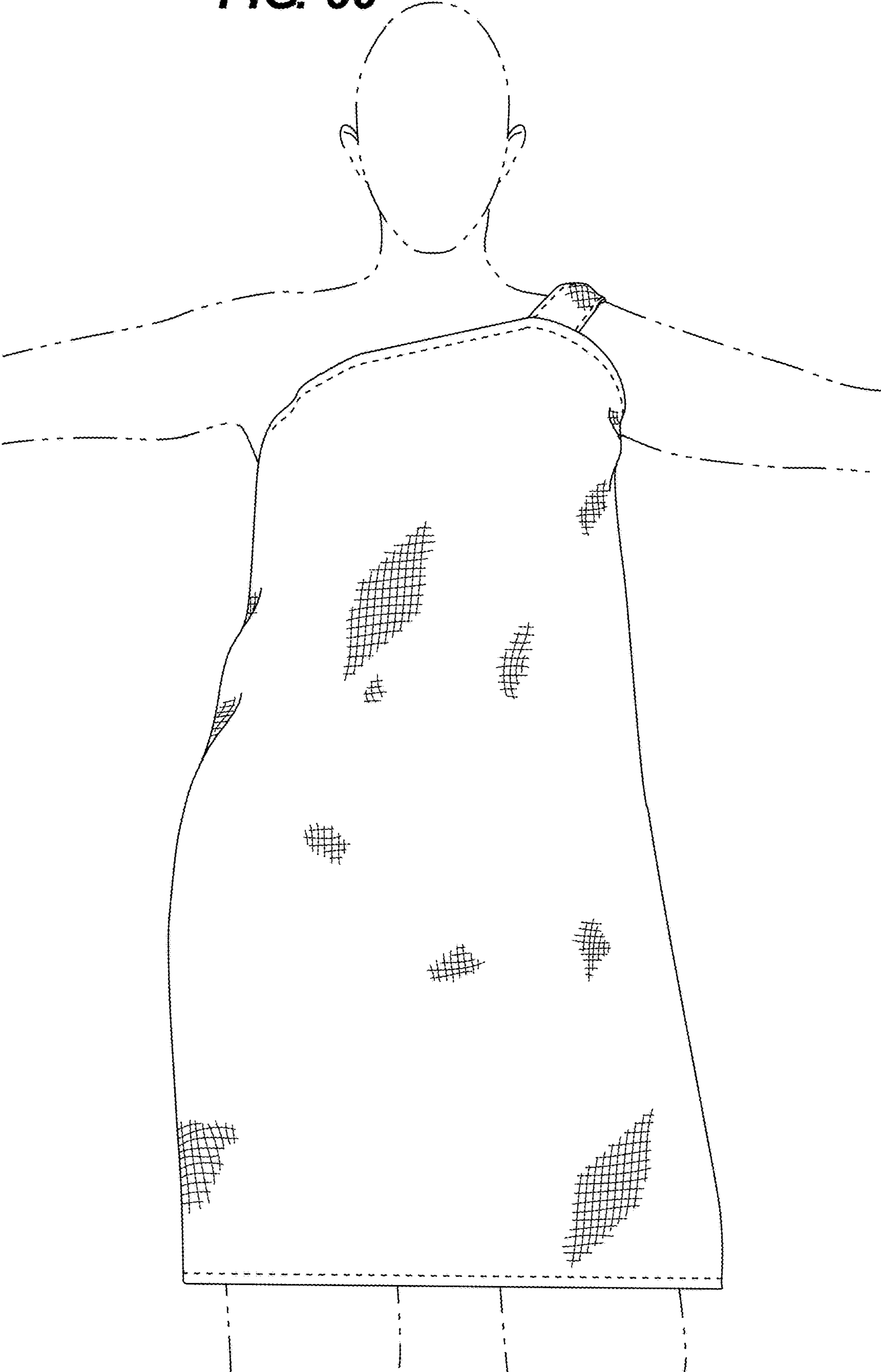
**FIG. 58**



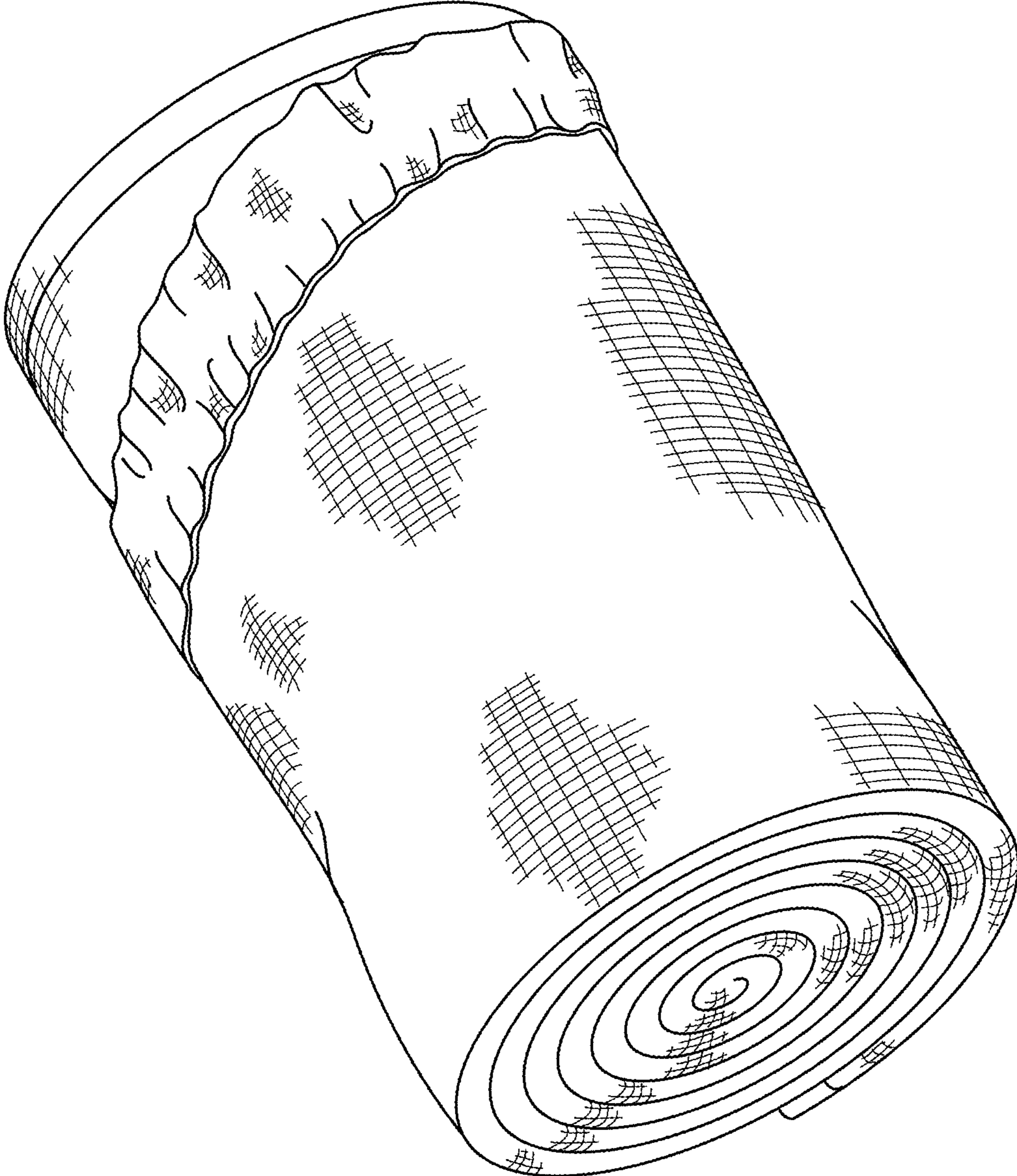
**FIG. 59**



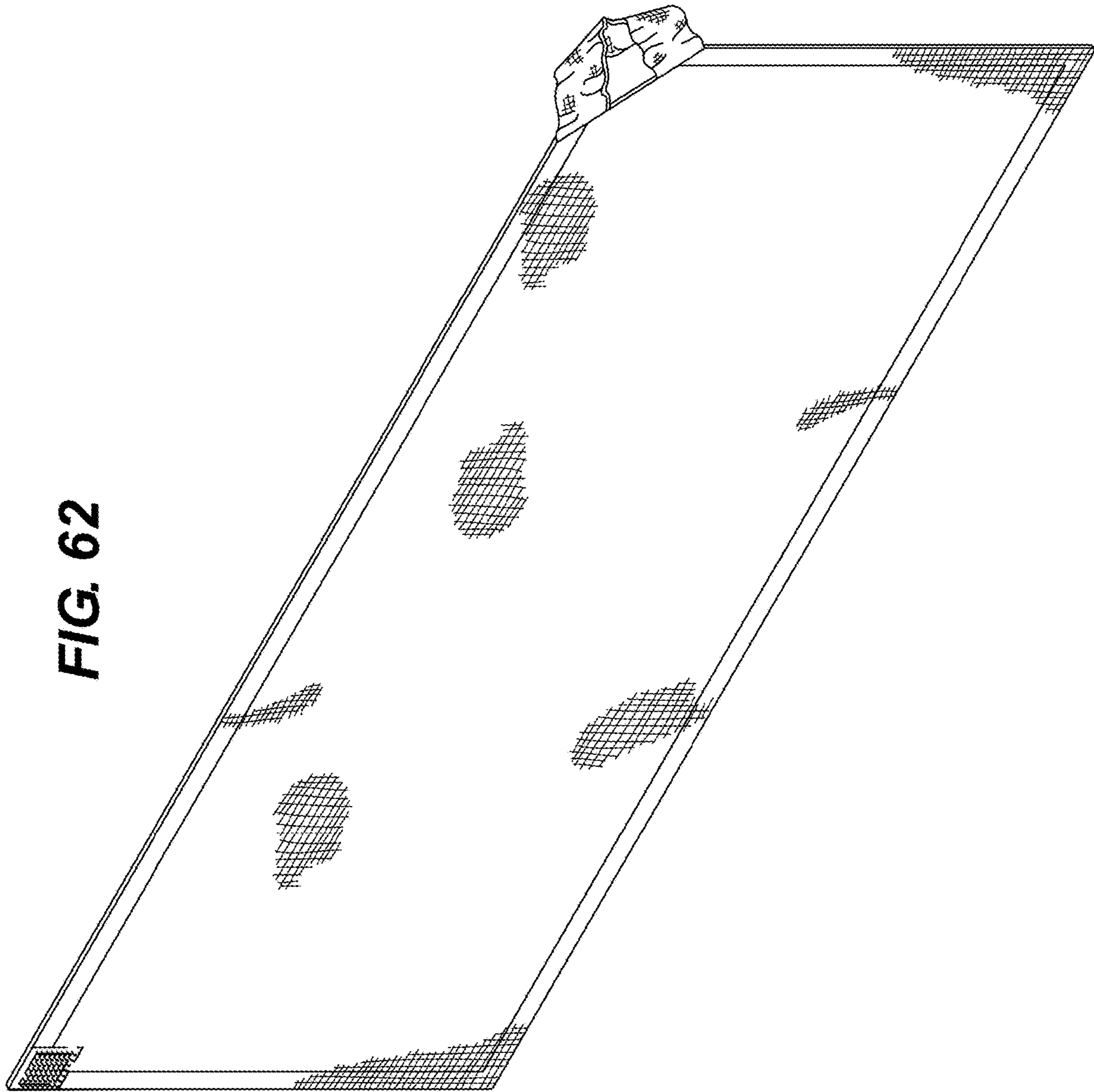
**FIG. 60**

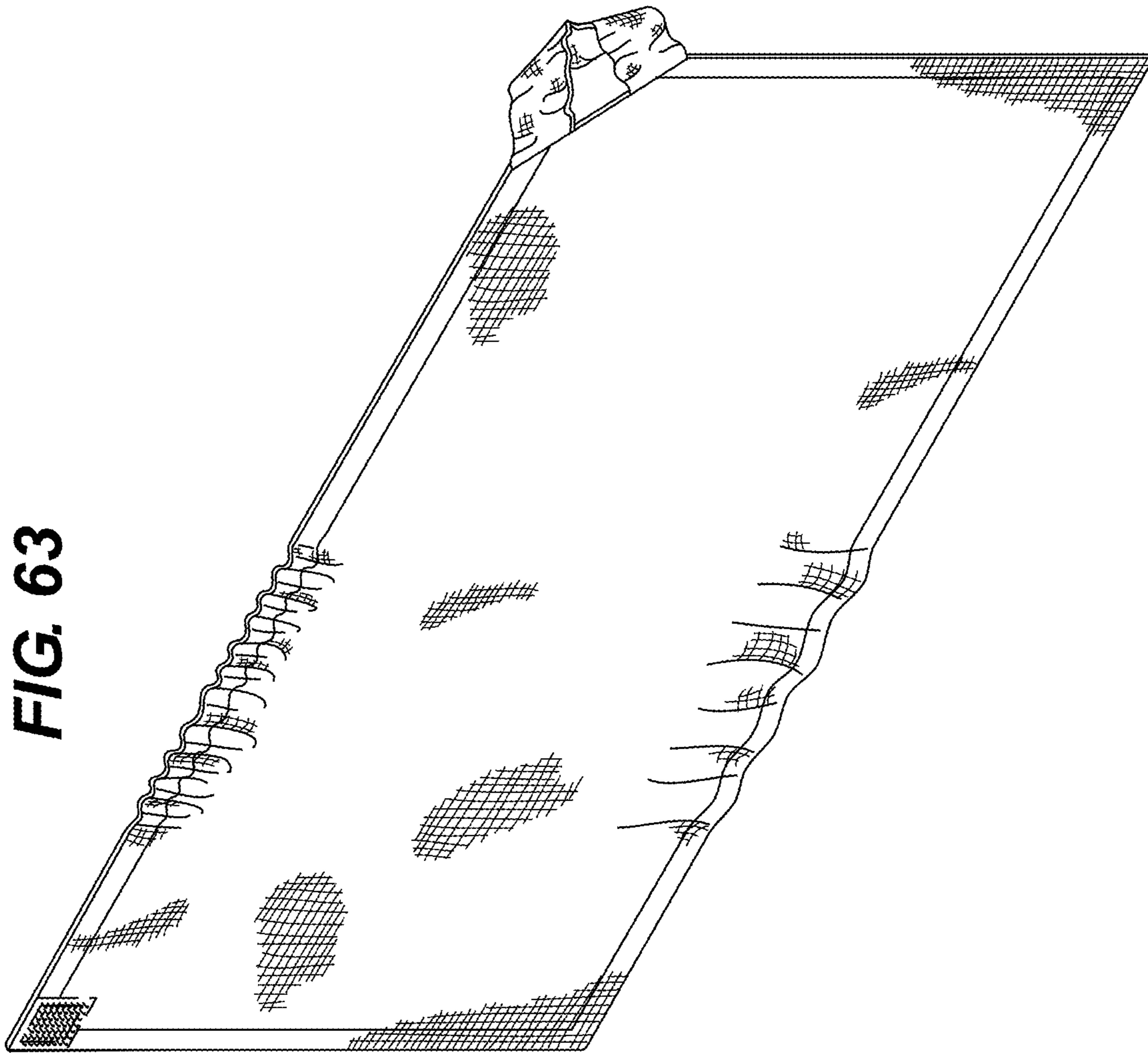


**FIG. 61**



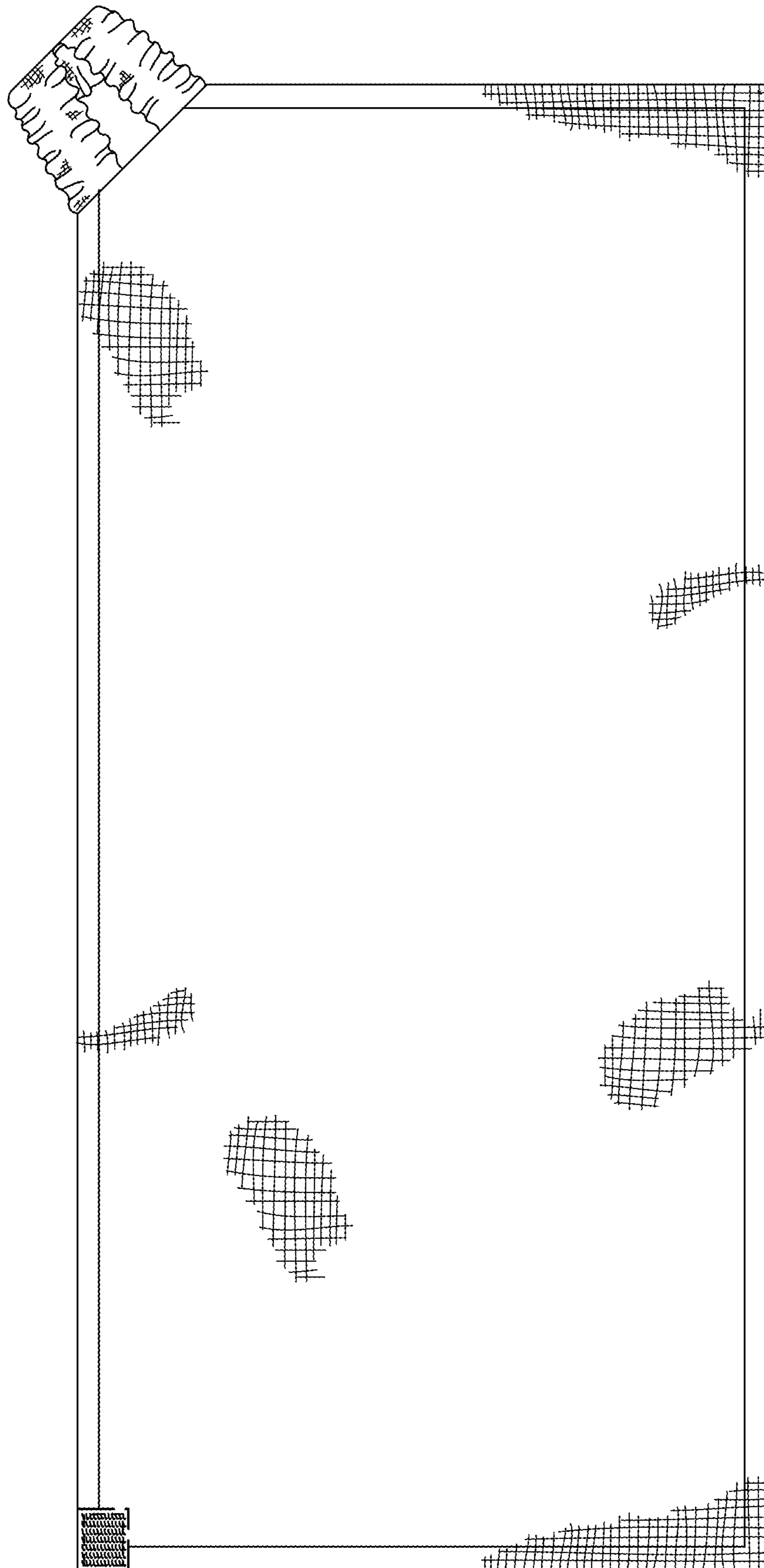
**FIG. 62**



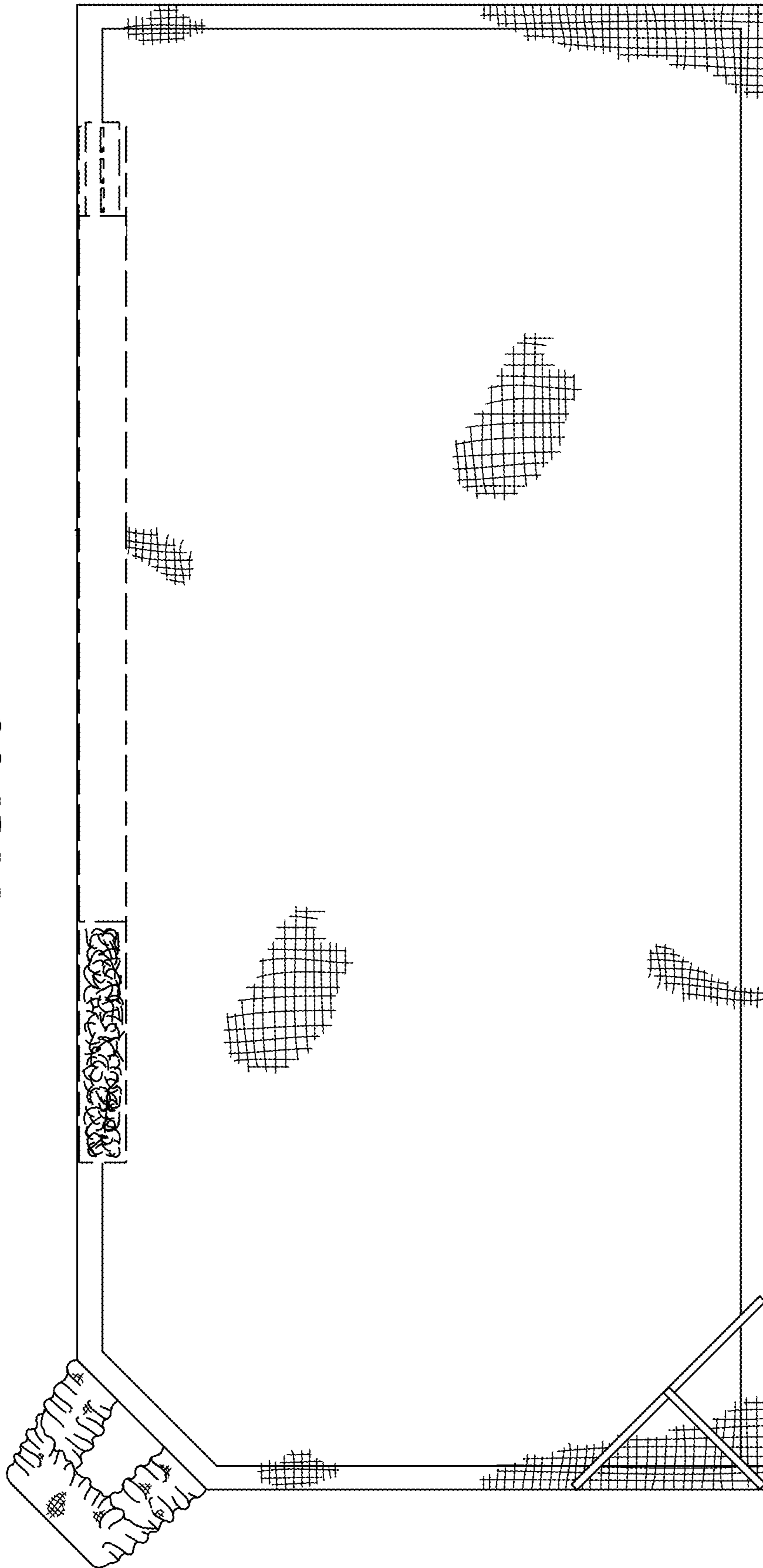


**FIG. 63**

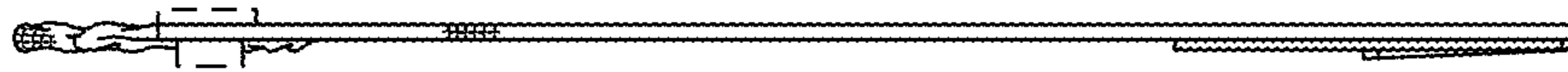
**FIG. 64**



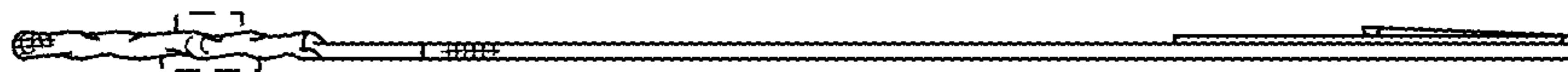
**FIG. 65**



**FIG. 67**



**FIG. 66**

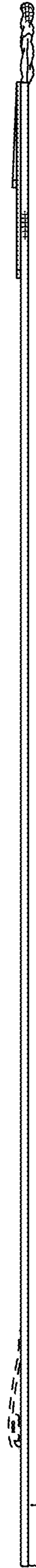




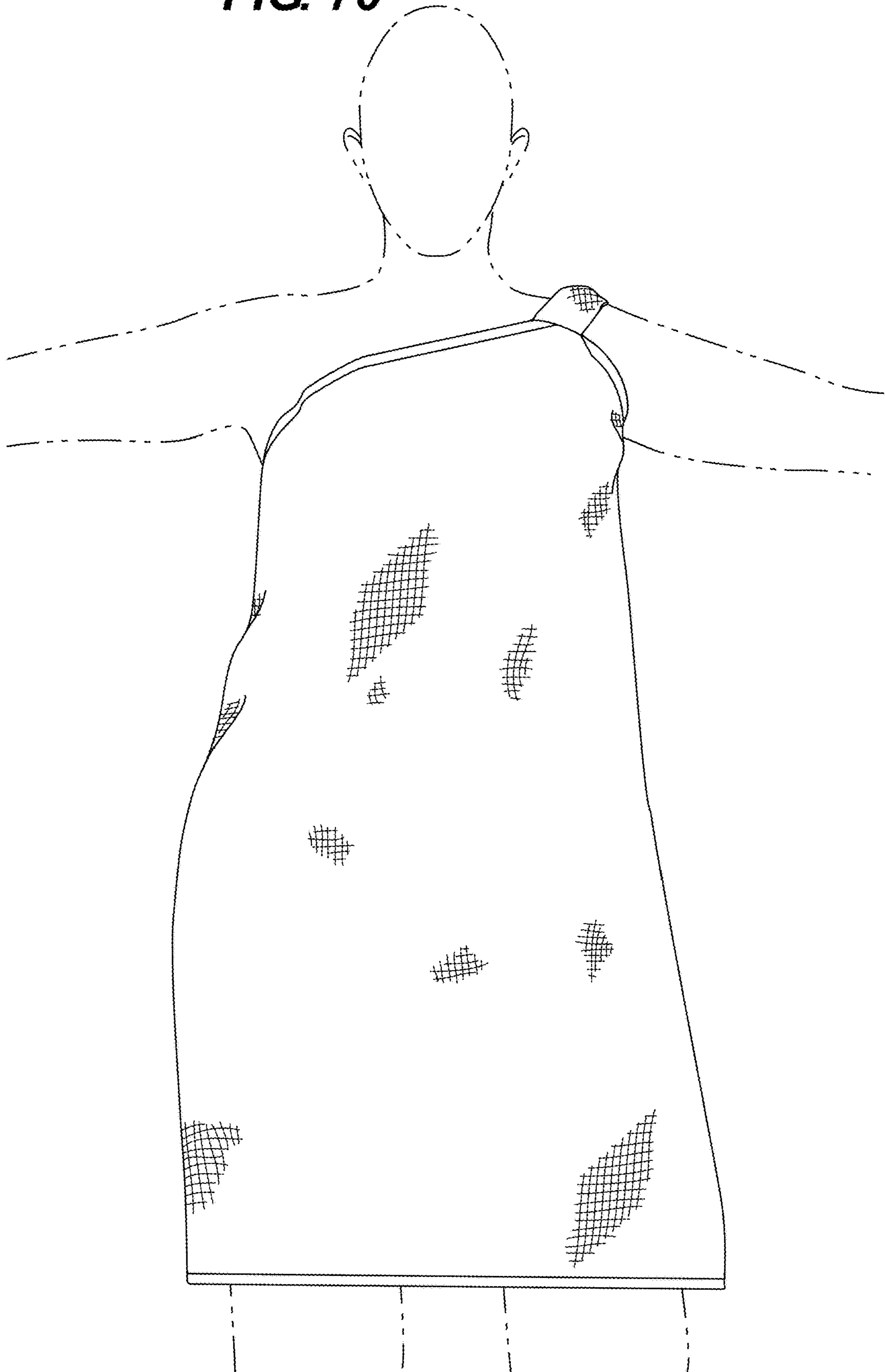
**FIG. 68**



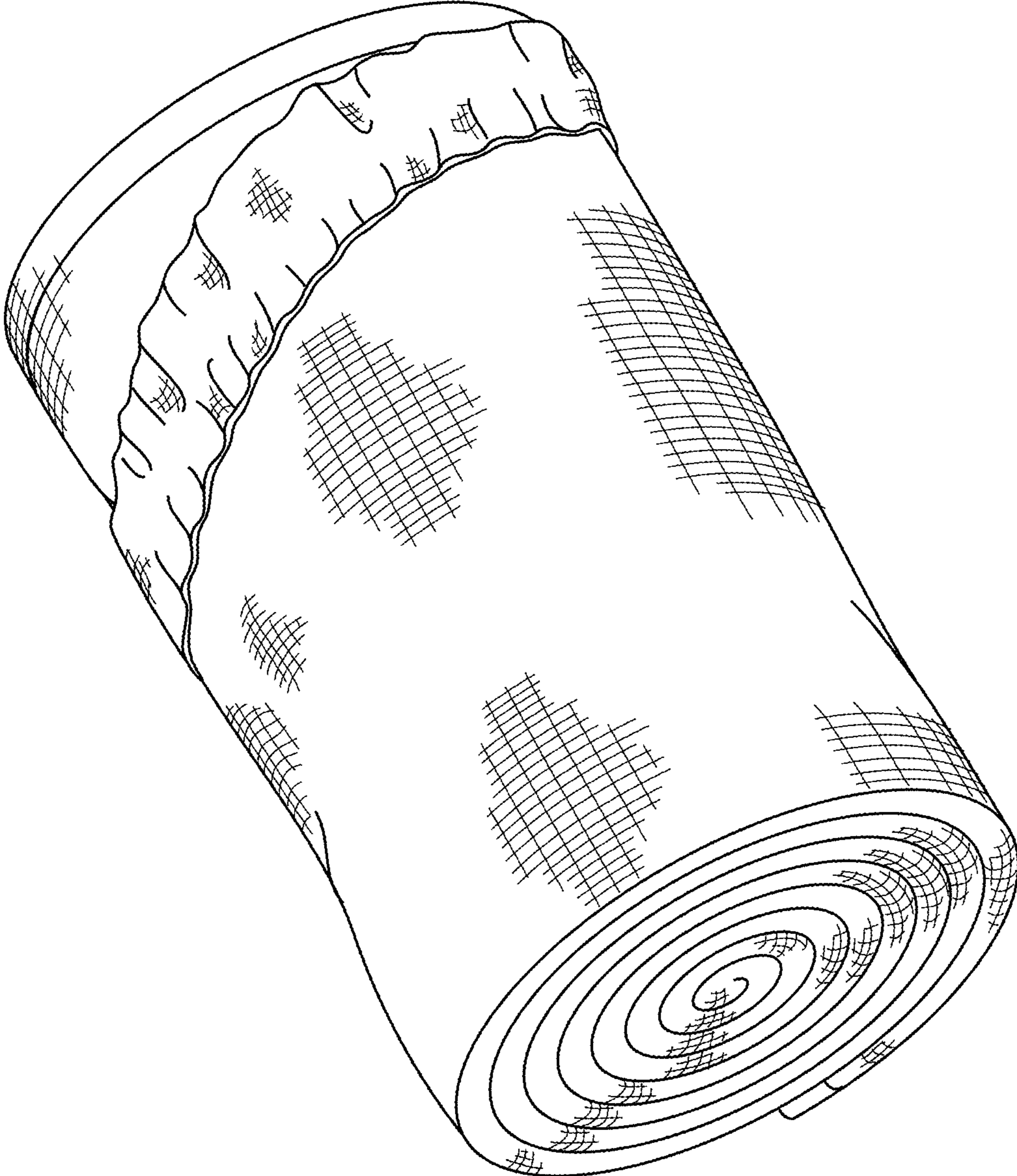
**FIG. 69**



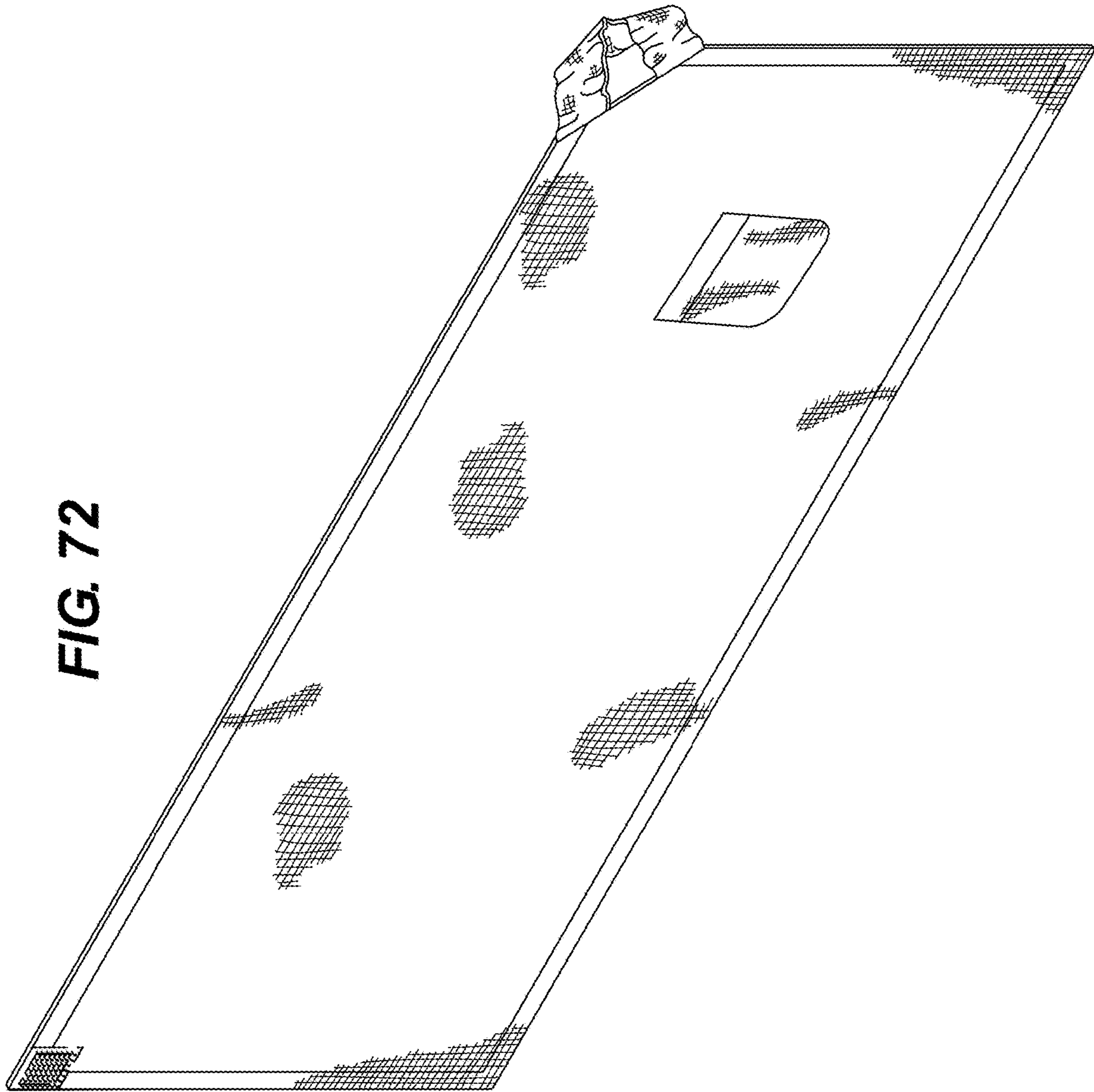
**FIG. 70**



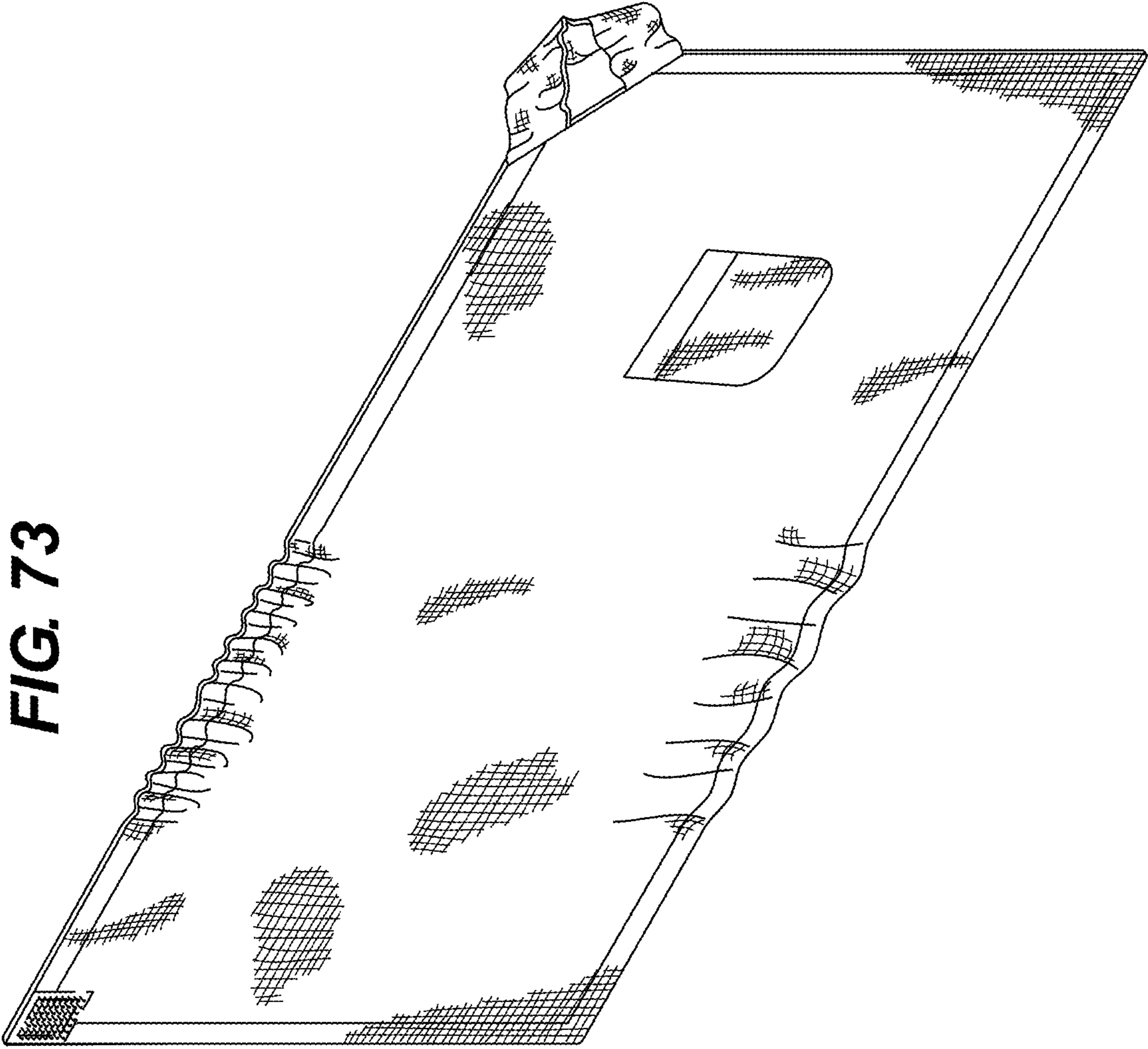
**FIG. 71**



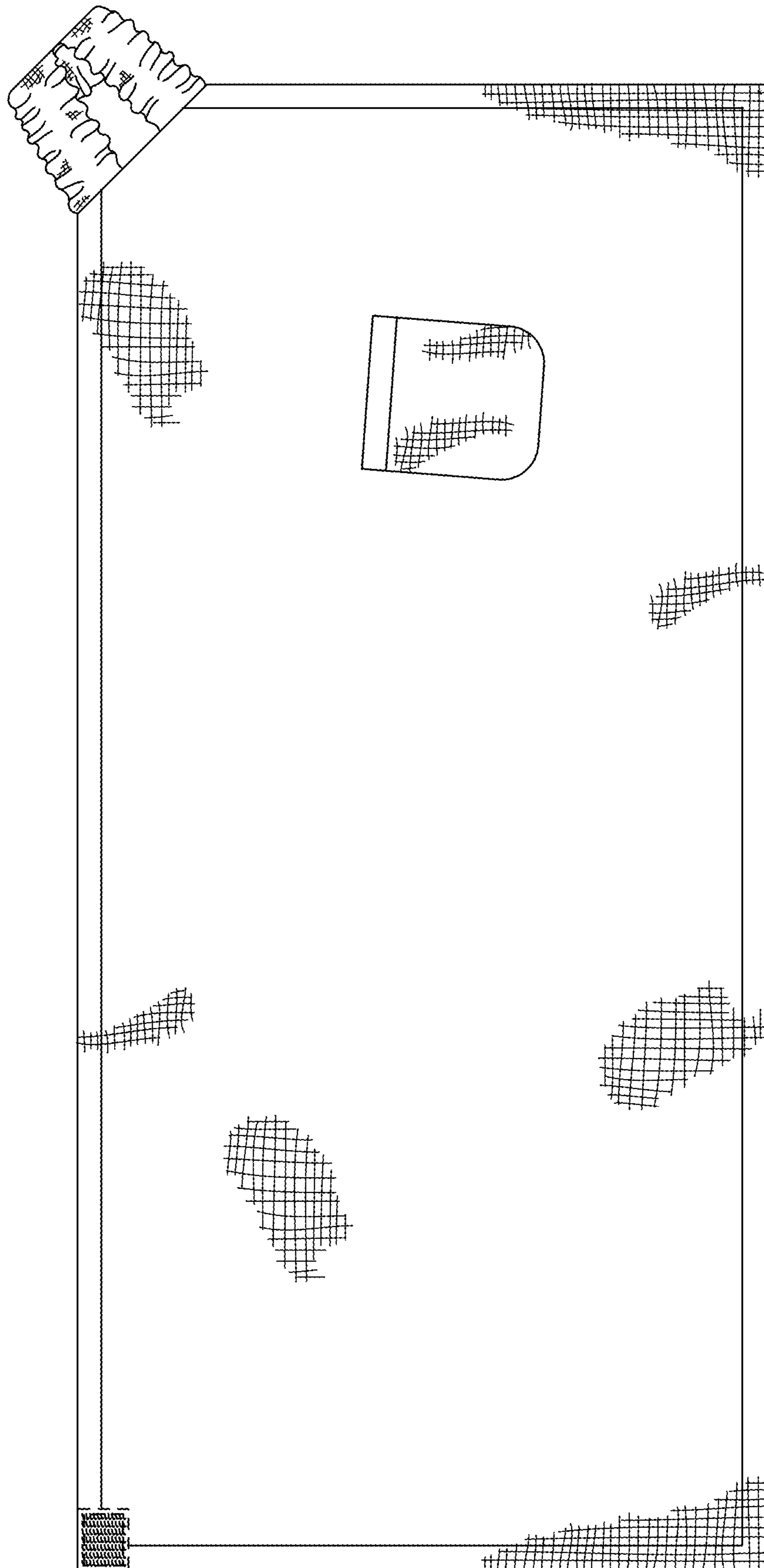
**FIG. 72**



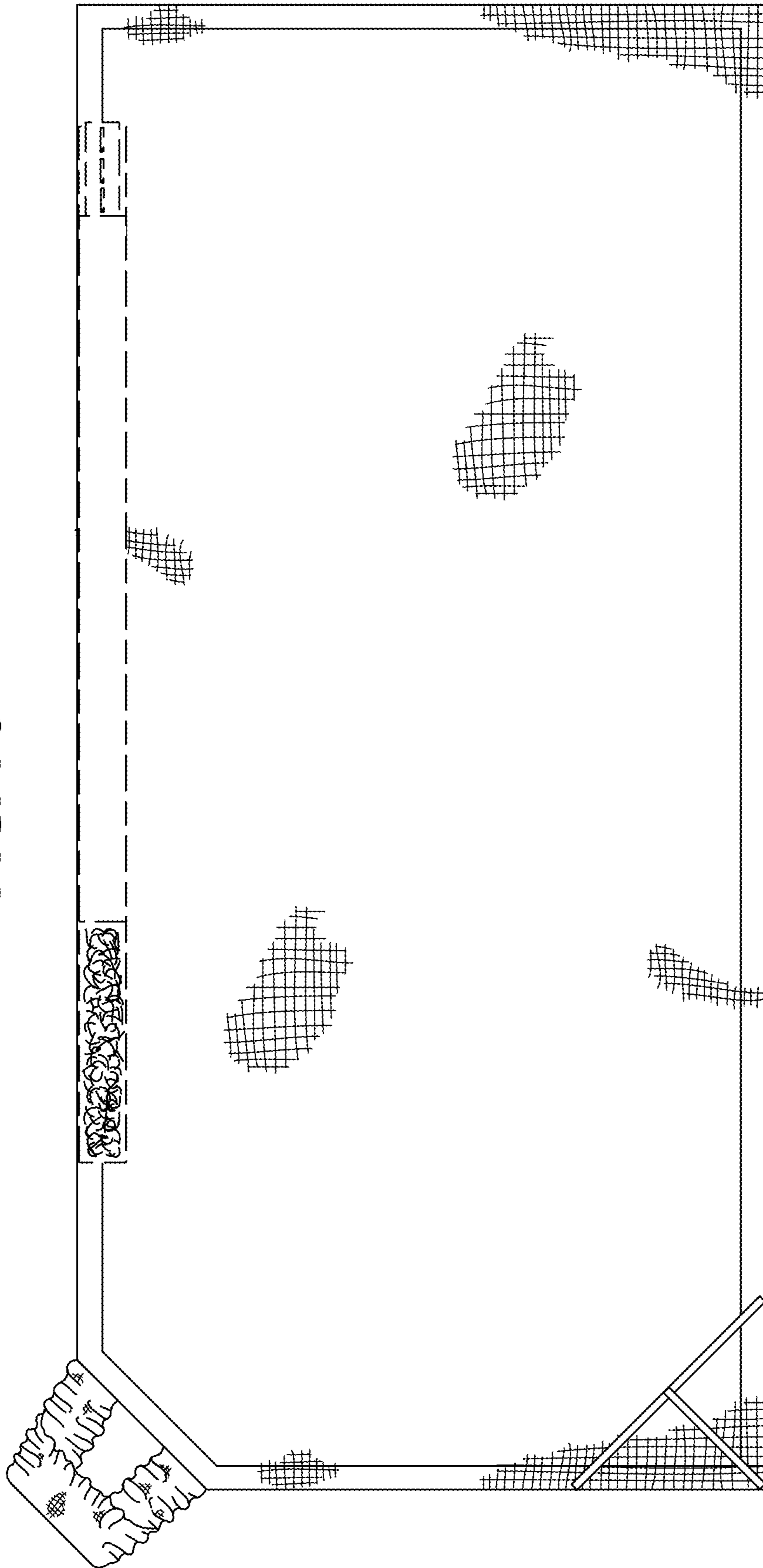
**FIG. 73**



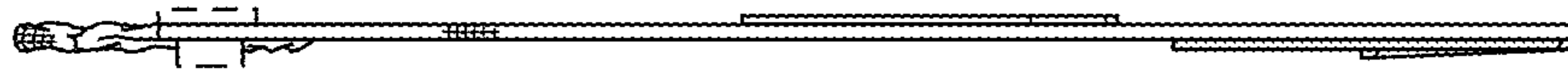
**FIG. 74**



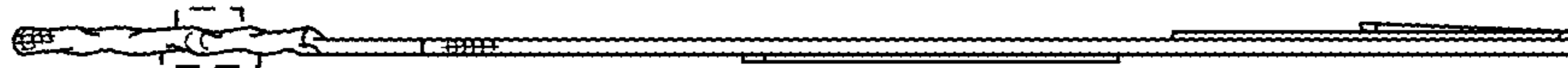
**FIG. 75**



**FIG. 77**

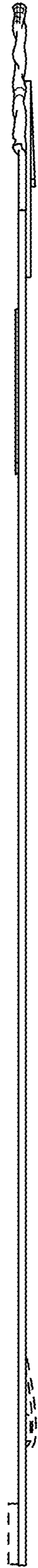


**FIG. 76**

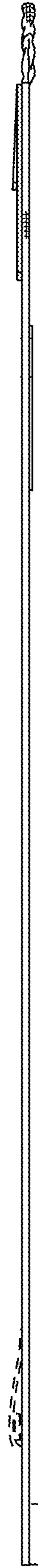




**FIG. 78**



**FIG. 79**



**FIG. 80**

