

US00D979070S

(12) **United States Design Patent** (10) **Patent No.:** **US D979,070 S**  
**Peabody** (45) **Date of Patent:** **\*\* Feb. 21, 2023**

(54) **MEDICAL DIAGNOSTIC DEVICE**

(56) **References Cited**

(71) Applicant: **Steven R. Peabody**, Zionsville, IN (US)

U.S. PATENT DOCUMENTS

(72) Inventor: **Steven R. Peabody**, Zionsville, IN (US)

D679,399	S	*	4/2013	Syu	.....	D24/167
D810,593	S	*	2/2018	Liu	.....	D24/167
D868,974	S	*	12/2019	Albert	.....	D24/167
D895,118	S	*	9/2020	Hwang	.....	D24/167
D918,391	S	*	5/2021	Hwang	.....	D24/167
D932,016	S	*	9/2021	Lam	.....	D24/167
D936,227	S	*	11/2021	Chang	.....	D24/167
D940,326	S	*	1/2022	Kinoshita	.....	D24/167
2008/0234592	A1	*	9/2008	Lim	.....	A61B 5/318 600/509
2017/0202464	A1	*	7/2017	Tsao	.....	A61B 5/332
2020/0138314	A1	*	5/2020	Doctor	.....	A61B 5/282
2020/0229765	A1	*	7/2020	Peabody	.....	A61B 5/6831

(\*\*) Term: **15 Years**

(21) Appl. No.: **29/795,660**

(22) Filed: **Jun. 19, 2021**

\* cited by examiner

**Related U.S. Application Data**

(63) Continuation of application No. 16/090,585, filed as application No. PCT/US2017/025689 on Apr. 3, 2017, now Pat. No. 11,064,948.

*Primary Examiner* — Anhdao Doan

(74) *Attorney, Agent, or Firm* — Brannon Sowers & Cracraft PC

(51) **LOC (14) Cl.** ..... **24-02**

(57) **CLAIM**

The ornamental design for a medical diagnostic device, as shown and described.

(52) **U.S. Cl.**

USPC ..... **D24/167; D24/186**

**DESCRIPTION**

(58) **Field of Classification Search**

USPC ..... D24/164, 165, 167, 168, 169, 186, 187, D24/107

CPC ..... A61B 5/0205; A61B 5/02405; A61B 5/02427; A61B 5/02438; A61B 5/0245; A61B 5/254; A61B 5/257; A61B 5/26; A61B 5/271; A61B 5/28; A61B 5/282; A61B 5/308; A61B 5/318; A61B 5/332; A61B 5/0022; A61B 5/02055; A61B 5/6898; A61B 5/1112; A61B 5/1117; A61B 5/1118; A61B 5/14532

FIG. 1 is a top perspective view of a medical diagnostic device, showing our new design;  
 FIG. 2 is a front side elevation view thereof;  
 FIG. 3 is a back side elevation view thereof;  
 FIG. 4 is a left side elevation view thereof;  
 FIG. 5 is a right side elevation view thereof;  
 FIG. 6 is a top plan view thereof;  
 FIG. 7 is a bottom plan view thereof; and,  
 FIG. 8 is a bottom perspective view thereof, showing a portion thereof in an alternate position.

See application file for complete search history.

**1 Claim, 7 Drawing Sheets**

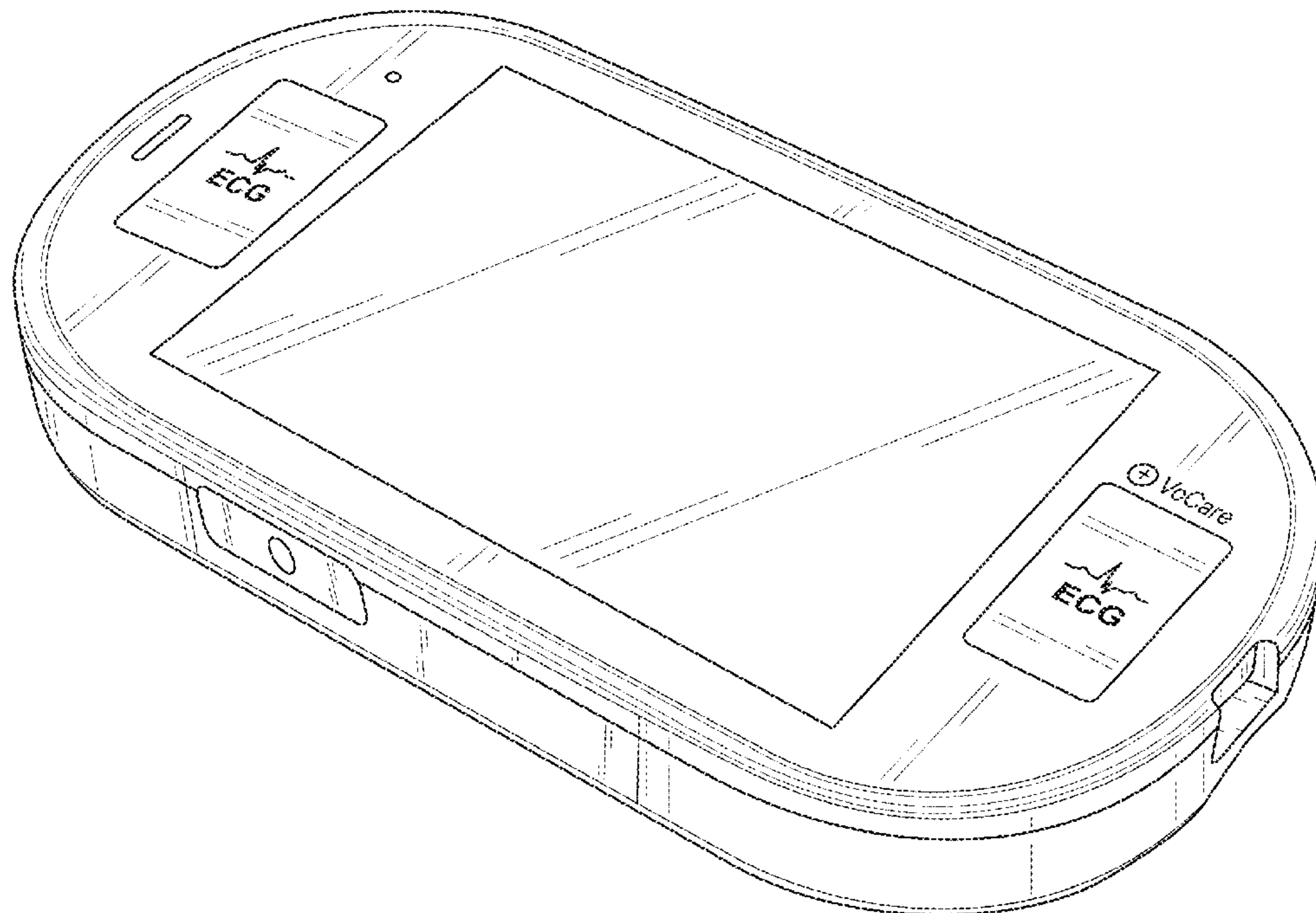

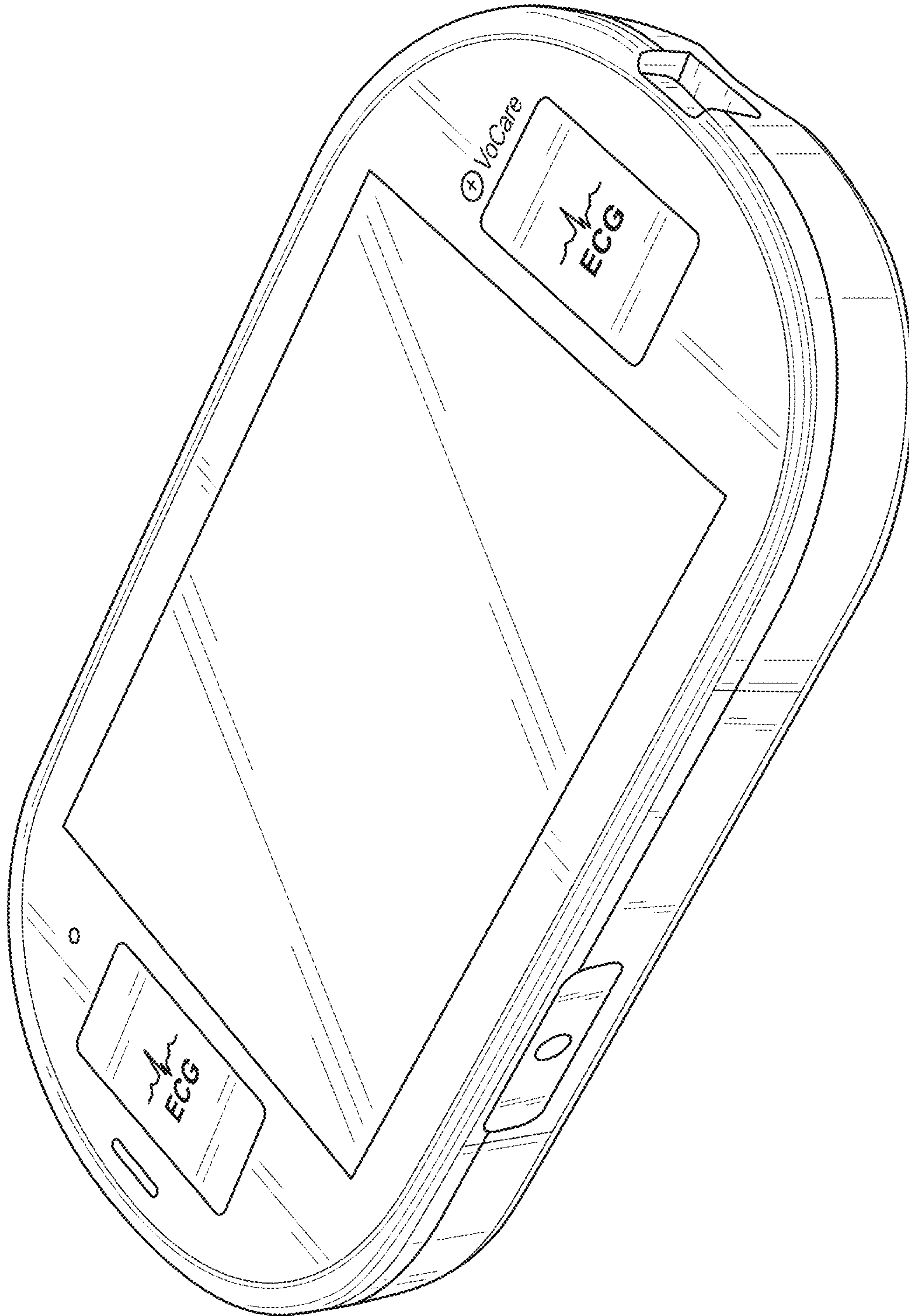

FIG. 1

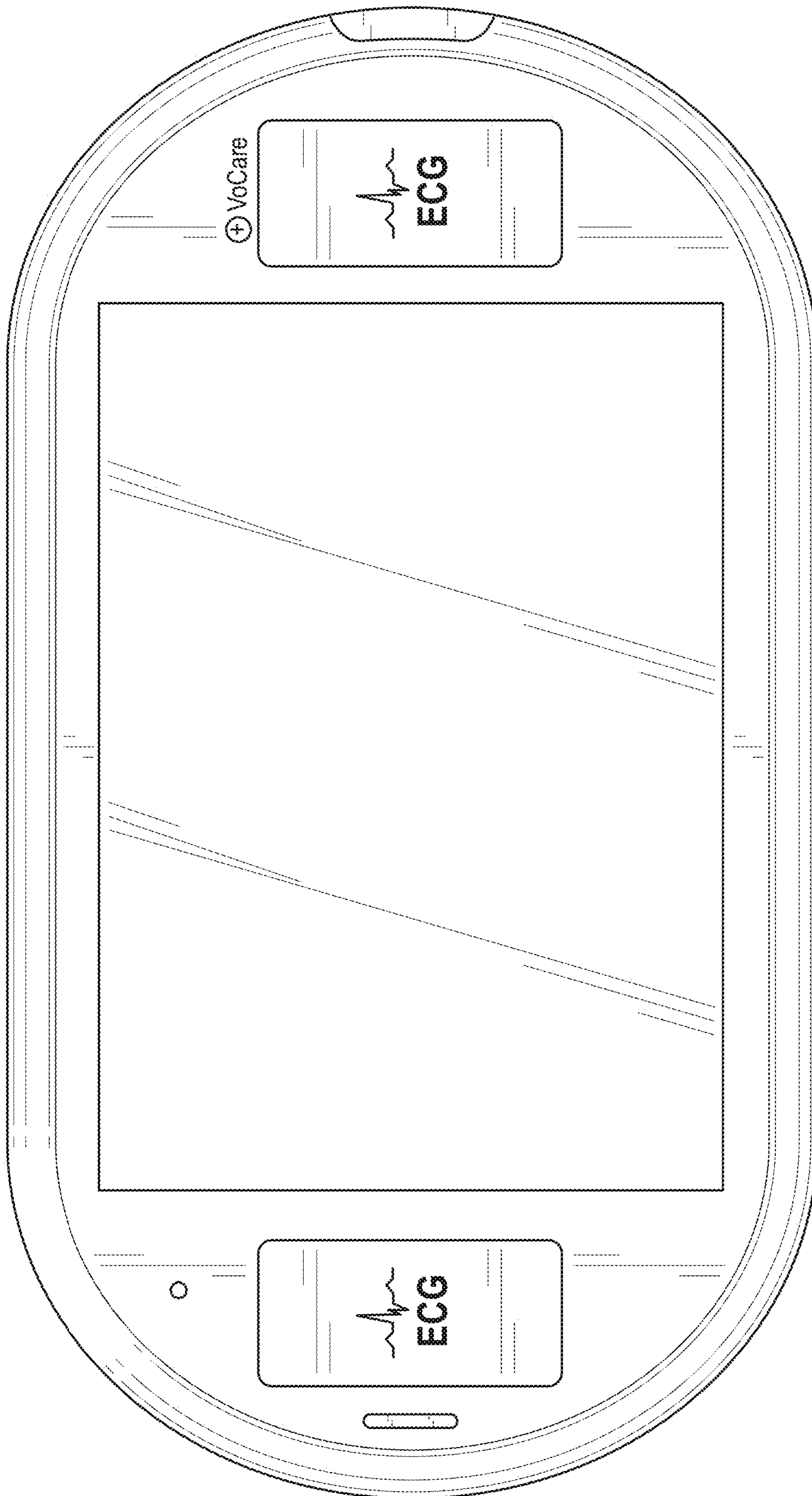

FIG. 2



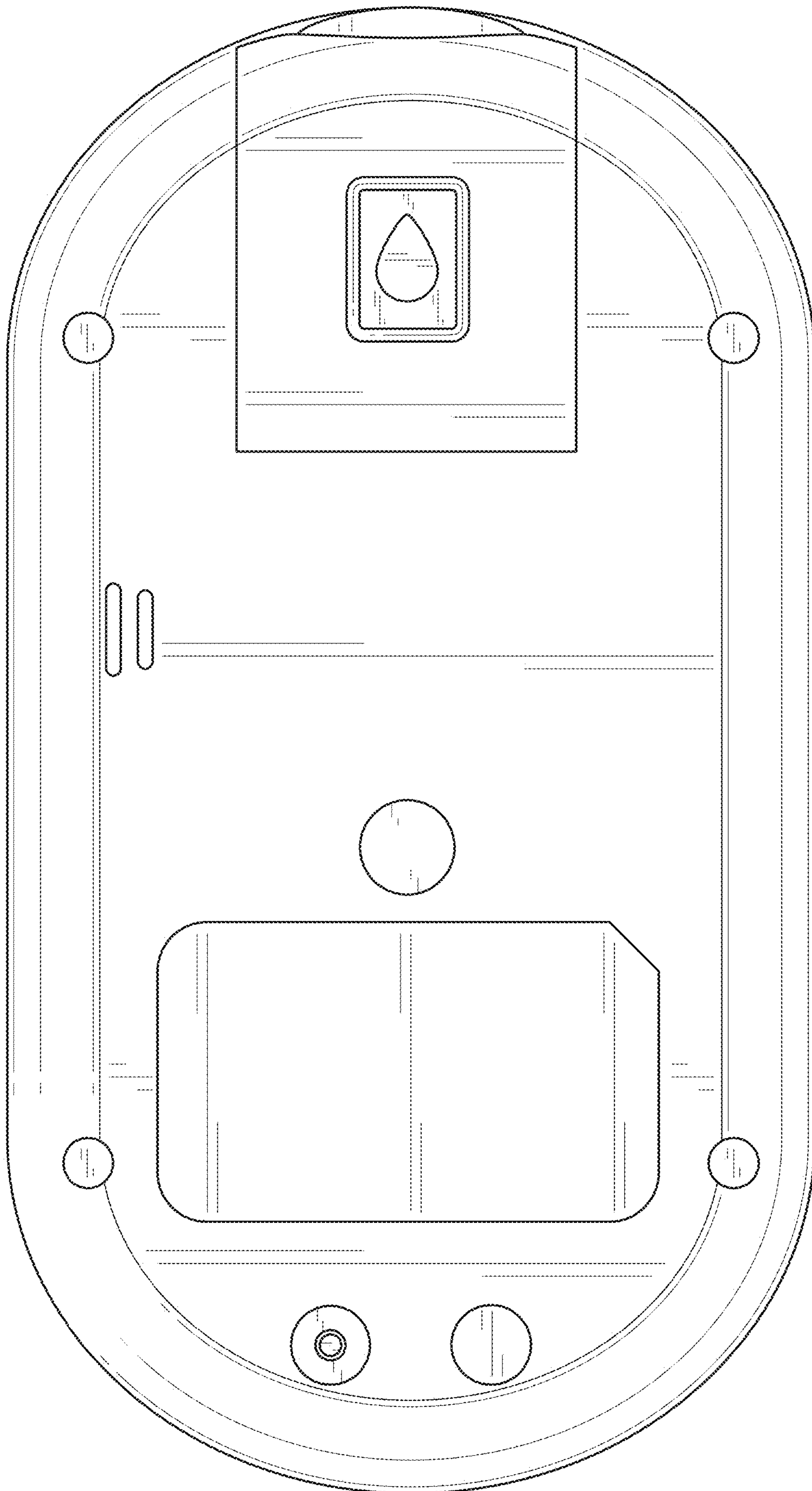

FIG. 3

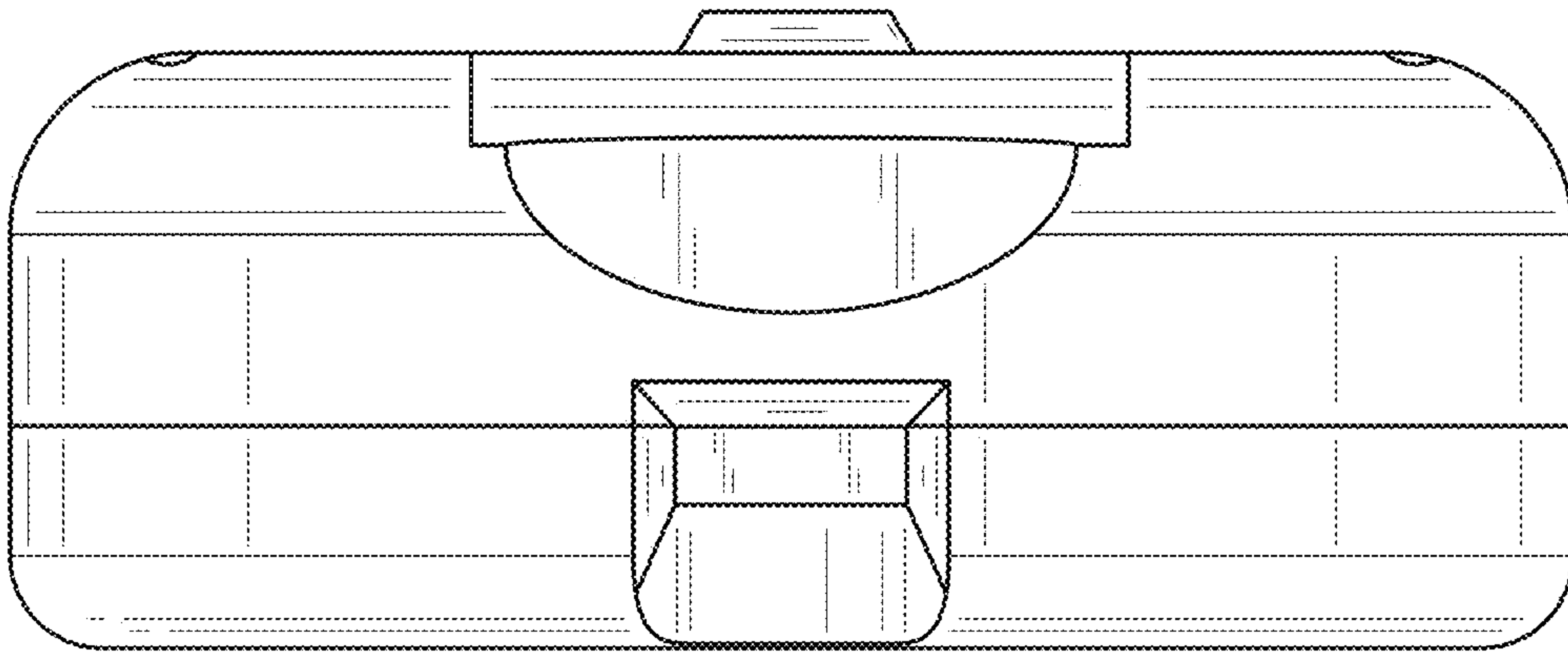

FIG. 5

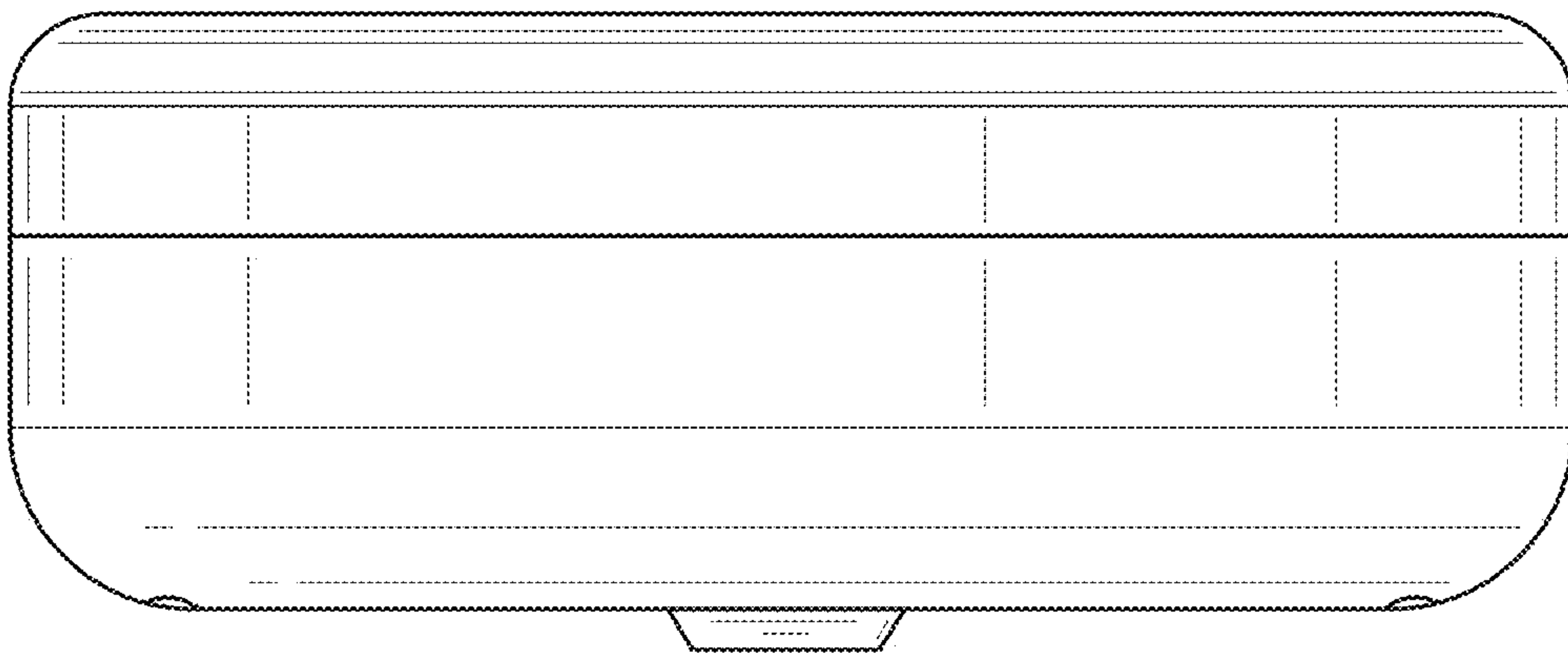

FIG. 4

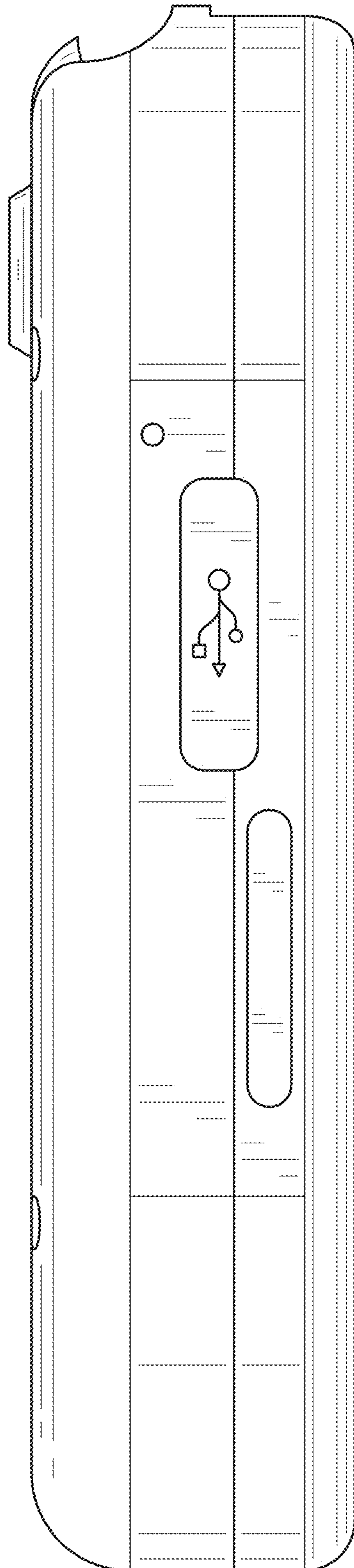

FIG. 6

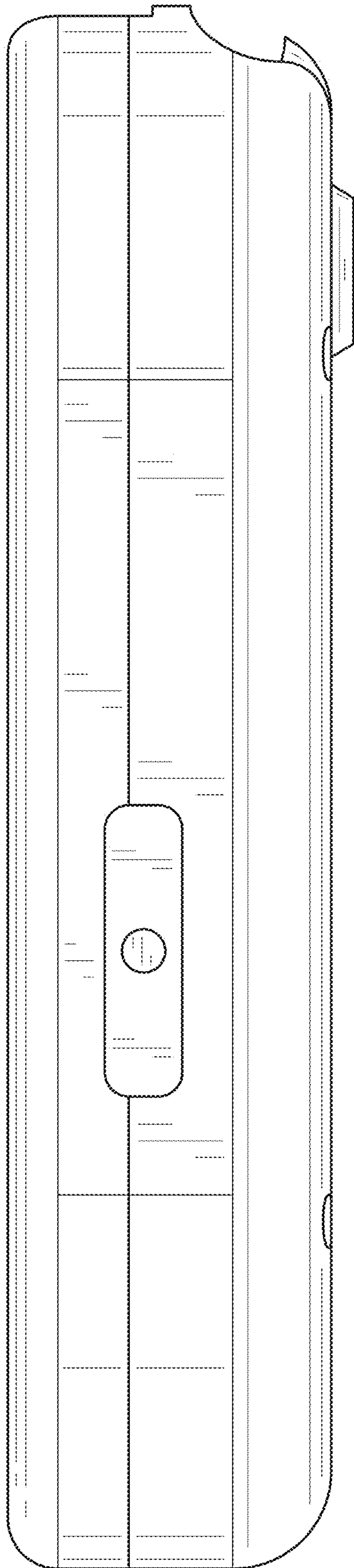

FIG. 7

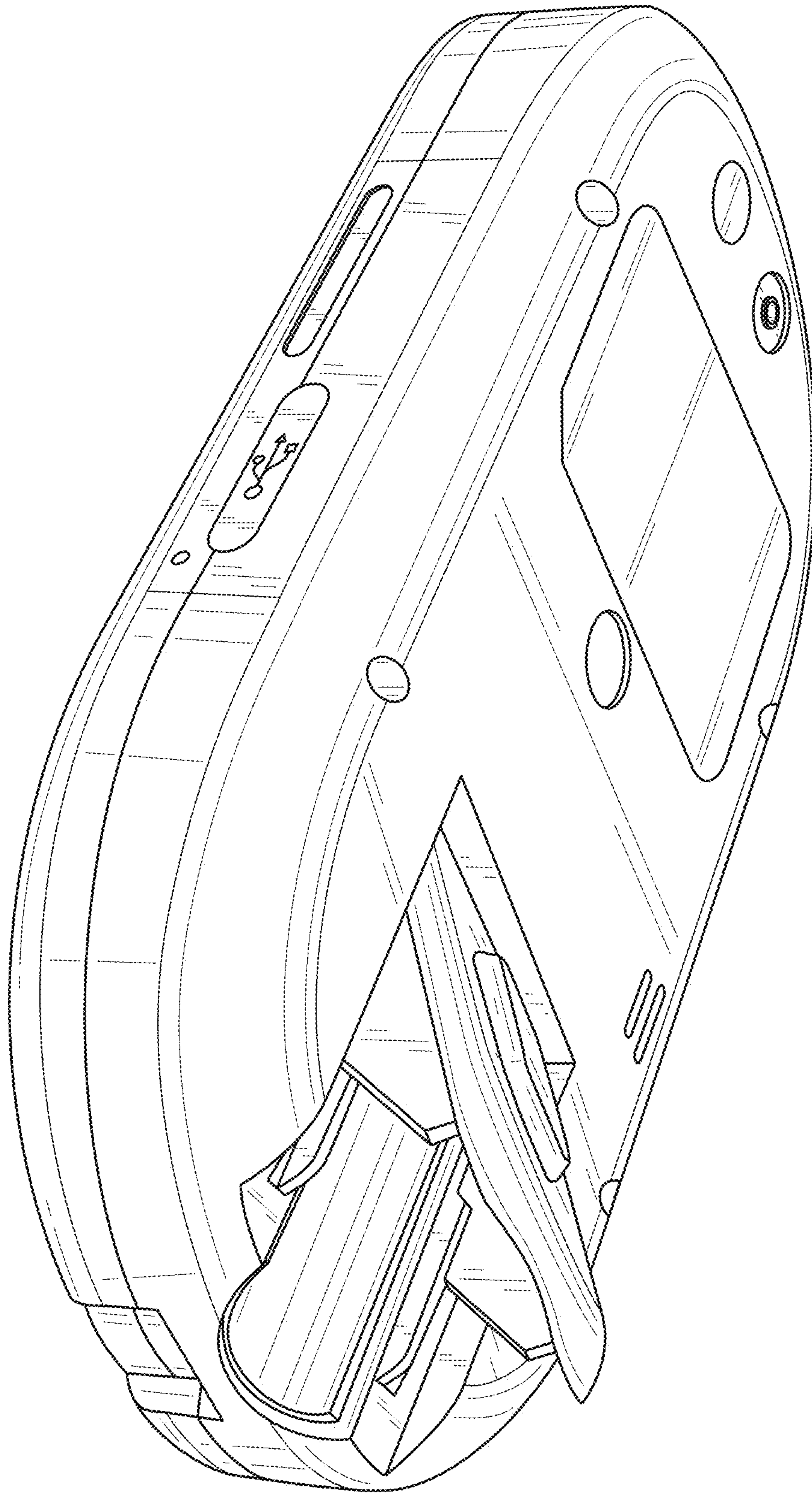

FIG. 8