

US00D979057S

(12) **United States Design Patent**
Bennett et al.

(10) **Patent No.:** **US D979,057 S**
(45) **Date of Patent:** **** Feb. 21, 2023**

(54) **FASTENER**

(71) Applicant: **ZIPTEK LLC**, Sarasota, FL (US)

(72) Inventors: **William F Bennett**, Sarasota, FL (US);
Ramses Galaz Mendez, Sonora (MX);
Daniel Francisco Gomez Romo,
Sonora (MX)

(73) Assignee: **ZIPTEK, LLC**, Sarasota, FL (US)

(**) Term: **15 Years**

(21) Appl. No.: **29/724,313**

(22) Filed: **Feb. 13, 2020**

Related U.S. Application Data

(63) Continuation of application No. 16/593,463, filed on
Oct. 4, 2019, which is a continuation of application
(Continued)

(51) **LOC (14) Cl.** **24-02**

(52) **U.S. Cl.**
USPC **D24/145**; D8/387

(58) **Field of Classification Search**
USPC D8/382, 385, 386, 387; D24/180, 171,
D24/231, 145

(Continued)

(56) **References Cited**

U.S. PATENT DOCUMENTS

4,950,270 A * 8/1990 Bowman A61B 17/1714
606/304
5,053,036 A * 10/1991 Perren A61B 17/8052
606/291

(Continued)

FOREIGN PATENT DOCUMENTS

CN 304658824 * 6/2018
CN 304843231 * 10/2018

(Continued)

Primary Examiner — Sheryl Lane

Assistant Examiner — Ieisha N Price

(74) *Attorney, Agent, or Firm* — Frijouf, Rust & Pyle
P.A.

(57) **CLAIM**

The ornamental design for a fastener, as shown and
described.

DESCRIPTION

FIG. 1 is a top isometric view of the first embodiment of a
fastener;

FIG. 2 is a bottom isometric view thereof;

FIG. 3 is a front view thereof;

FIG. 4 is a rear view thereof;

FIG. 5 is a left side view thereof;

FIG. 6 is a right side view thereof;

FIG. 7 is a top view thereof;

FIG. 8 is a bottom view thereof;

FIG. 9 is a top isometric view of the second embodiment of
a fastener;

FIG. 10 is a bottom isometric view thereof;

FIG. 11 is a front view thereof;

FIG. 12 is a rear view thereof;

FIG. 13 is a left side view thereof;

FIG. 14 is a right side view thereof;

FIG. 15 is a top view thereof;

FIG. 16 is a bottom view thereof;

FIG. 17 is a top isometric view of the third embodiment of
a fastener;

FIG. 18 is a bottom isometric view thereof;

FIG. 19 is a front view thereof;

FIG. 20 is a rear view thereof;

FIG. 21 is a left side view thereof;

FIG. 22 is a right side view thereof;

FIG. 23 is a top view thereof; and,

FIG. 24 is a bottom view thereof.

The broken lines in the drawings illustrate portions of the
fastener which form no part of the claimed design.

1 Claim, 12 Drawing Sheets

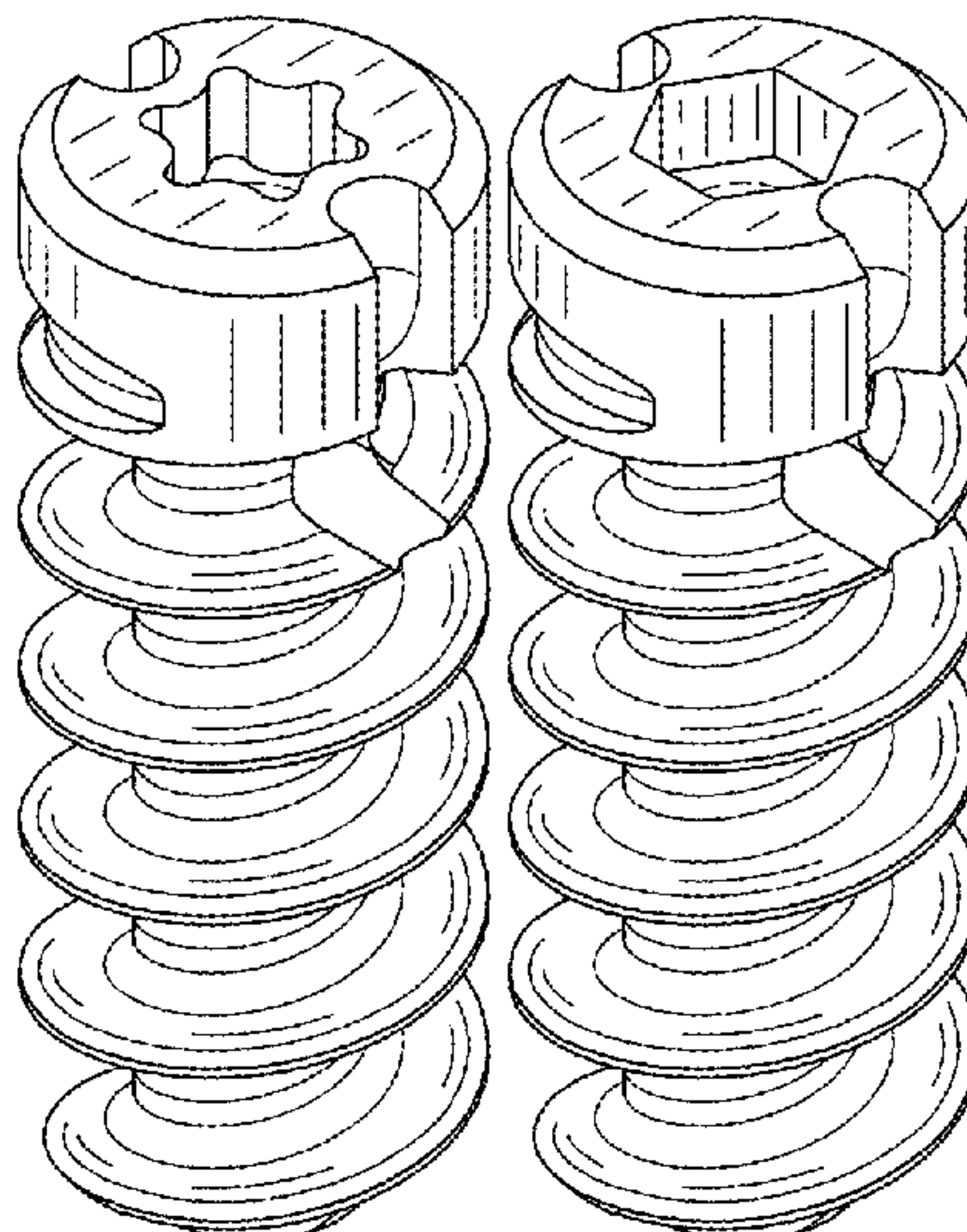

Related U.S. Application Data

No. 15/858,695, filed on Dec. 29, 2017, now Pat. No. 10,441,277, which is a continuation of application No. 14/203,846, filed on Mar. 11, 2014, now Pat. No. 9,855,033.

(58) **Field of Classification Search**

CPC F16B 13/003; F16B 13/004; F16B 13/005; F16B 2013/007; F16B 2013/009; F16B 13/02; F16B 13/04; F16B 13/045; F16B 13/06; F16B 13/063; F16B 13/065; F16B 13/066; F16B 13/068; F16B 13/08; F16B 13/0825; F16B 13/124; F16B 13/128; F16B 23/00; F16B 23/0007; F16B 33/00; F16B 33/02; F16B 35/00; F16B 35/06; A61B 17/861; A61B 17/0401; A61B 17/0482; A61B 2017/0414; A61B 2017/044; A61B 2017/0464; A61F 2/0811; A61F 2002/0817; A61F 2002/0858

See application file for complete search history.

(56) **References Cited**

U.S. PATENT DOCUMENTS

5,156,616 A * 10/1992 Meadows A61F 2/0811
606/232
5,443,509 A * 8/1995 Boucher A61B 17/8625
606/60
5,470,334 A * 11/1995 Ross A61B 17/8645
606/77
5,707,394 A * 1/1998 Miller A61B 17/0485
606/232
5,849,004 A * 12/1998 Bramlet A61B 17/0401
606/310
5,968,045 A * 10/1999 Frazier A61F 2/0811
606/232
6,283,973 B1 * 9/2001 Hubbard A61B 17/8615
411/393
6,368,322 B1 * 4/2002 Luks A61B 17/861
606/308
6,558,094 B2 * 5/2003 Nehl F16B 13/061
411/908
6,610,080 B2 * 8/2003 Morgan A61B 17/1796
606/232
6,685,728 B2 * 2/2004 Sinnott A61F 2/0811
606/232
6,730,092 B2 * 5/2004 Songer A61B 17/0401
606/309
6,837,658 B2 * 1/2005 Nehl F16B 13/124
411/36
7,135,025 B2 * 11/2006 Pohjonen A61B 17/866
606/321
7,288,094 B2 * 10/2007 Lindemann A61B 17/8042
606/86 A
D587,807 S * 3/2009 Wolf D24/145
7,588,587 B2 * 9/2009 Barbieri A61B 17/0401
606/232
D622,847 S * 8/2010 Berberich D24/145
D628,292 S * 11/2010 Berberich D24/145
7,883,529 B2 * 2/2011 Sinnott A61F 2/0811
606/232
7,942,913 B2 * 5/2011 Ziolo A61B 17/8047
606/287
8,100,955 B2 * 1/2012 Blain A61B 17/8042
606/291

8,197,511 B2 * 6/2012 Miller A61B 17/0401
606/232
8,226,714 B2 * 7/2012 Beck, Jr. A61F 2/0811
623/13.12
8,579,940 B2 * 11/2013 Dreyfuss A61B 17/0401
606/232
8,623,019 B2 * 1/2014 Perrow A61B 17/1671
606/279
8,696,721 B2 * 4/2014 Blain A61B 17/86
606/313
D740,417 S * 10/2015 Chavan D24/145
D740,418 S * 10/2015 Chavan D24/145
D740,419 S * 10/2015 Chavan D24/145
D741,480 S * 10/2015 Chavan D24/145
9,393,006 B2 * 7/2016 Housman A61B 17/861
D812,751 S * 3/2018 Richter D24/146
D819,432 S * 6/2018 Bennett D8/387
10,001,155 B2 * 6/2018 Nehl F16B 13/124
10,001,157 B2 * 6/2018 Nehl F16B 13/124
10,085,737 B2 * 10/2018 Boock A61B 17/0401
10,206,722 B2 * 2/2019 Perrow A61B 17/8047
D846,977 S * 4/2019 Williams D8/387
D855,183 S * 7/2019 Alladu D24/155
D868,967 S * 12/2019 Sauer D24/145
D914,213 S * 3/2021 Thies D24/145
10,959,830 B2 * 3/2021 Williams A61F 2/0811
D921,479 S * 6/2021 Smith D8/387
D927,295 S * 8/2021 Lanois D8/387
2002/0052629 A1 * 5/2002 Morgan A61B 17/0401
606/232
2004/0106950 A1 * 6/2004 Grafton A61B 17/0401
606/232
2004/0127904 A1 * 7/2004 Konieczynski A61B 17/8052
606/70
2006/0149258 A1 * 7/2006 Sousa A61F 2/0811
623/13.12
2007/0135841 A1 * 6/2007 Dreyfuss A61B 17/0401
606/232
2007/0173845 A1 * 7/2007 Kim A61B 17/0401
606/232
2007/0213730 A1 * 9/2007 Martinek A61B 17/0401
606/326
2008/0077139 A1 * 3/2008 Landry A61B 17/7037
606/86 A
2008/0275510 A1 * 11/2008 Schonhardt A61B 17/8047
606/286
2009/0198288 A1 * 8/2009 Hoof A61B 17/8605
606/301
2010/0262186 A1 * 10/2010 Sodeika A61B 17/0401
606/232
2011/0270326 A1 * 11/2011 Black A61B 17/8038
606/308
2014/0228866 A1 * 8/2014 Fallin A61B 17/0401
606/144
2015/0289917 A1 * 10/2015 Wotton, III A61B 17/861
606/304
2016/0030032 A1 * 2/2016 Dougherty A61B 17/0401
606/232
2018/0092751 A1 * 4/2018 Vrionis A61F 2/447
2018/0110904 A1 * 4/2018 Woo A61B 17/0401
2018/0235681 A1 * 8/2018 Chambers A61B 17/861
2019/0380692 A1 * 12/2019 Brazil A61B 17/0401
2020/0170633 A1 * 6/2020 Roberts G16H 20/40

FOREIGN PATENT DOCUMENTS

IN 304650-0001 * 5/2019
JP D1249148 * 8/2005
KR 300722821.0000 * 1/2014
NZ 422282-0001 * 5/2016

* cited by examiner

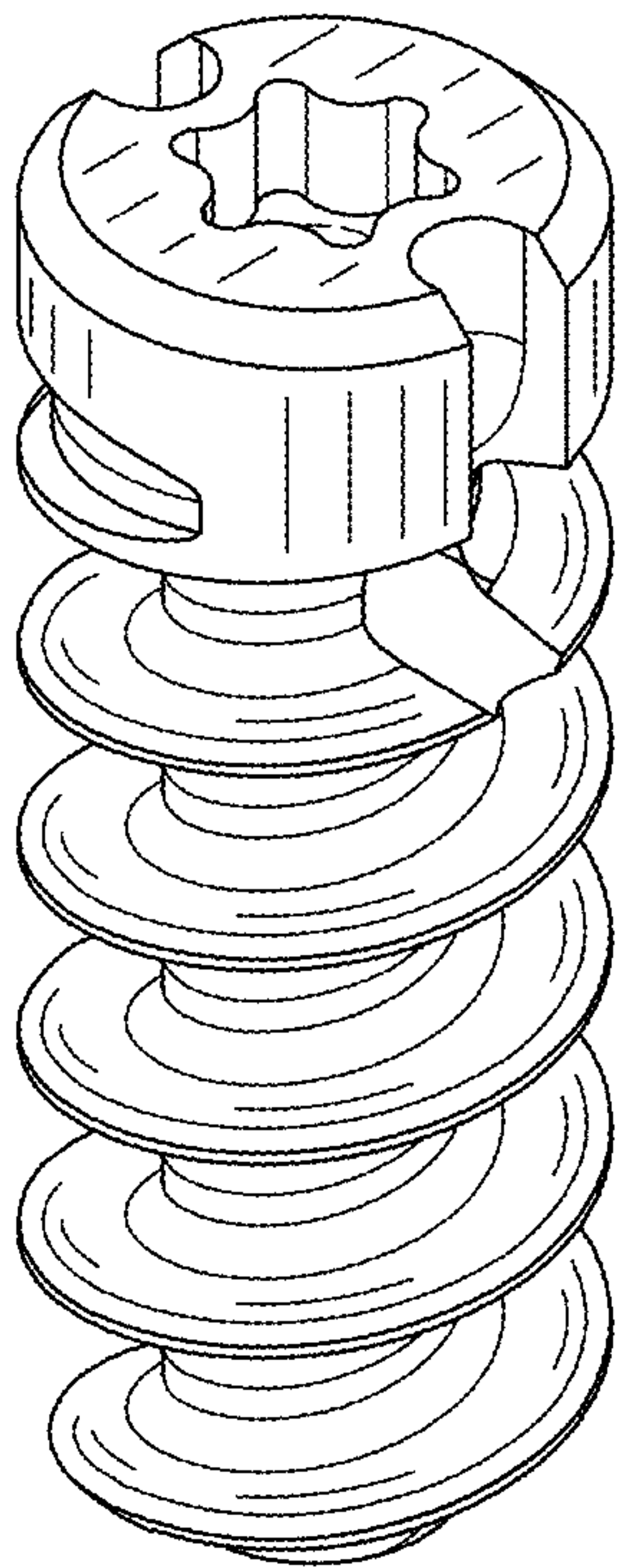

FIG. 1

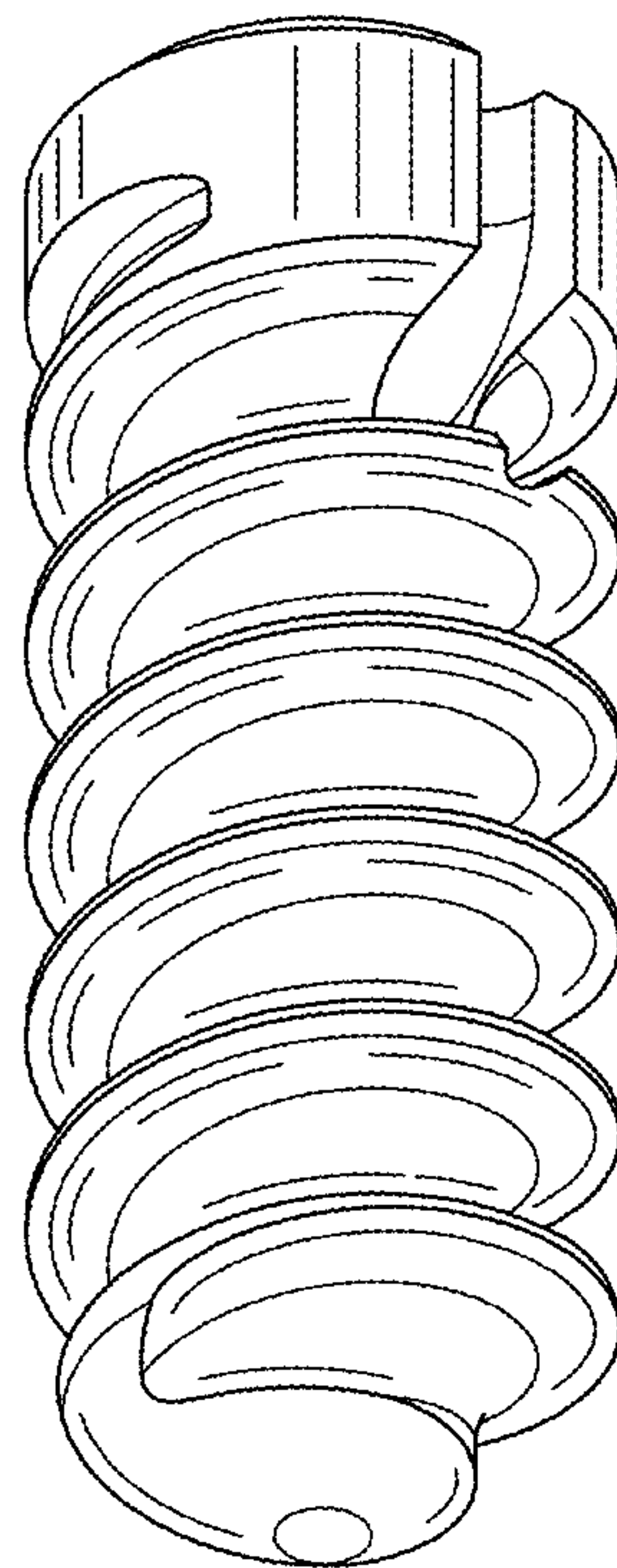

FIG. 2

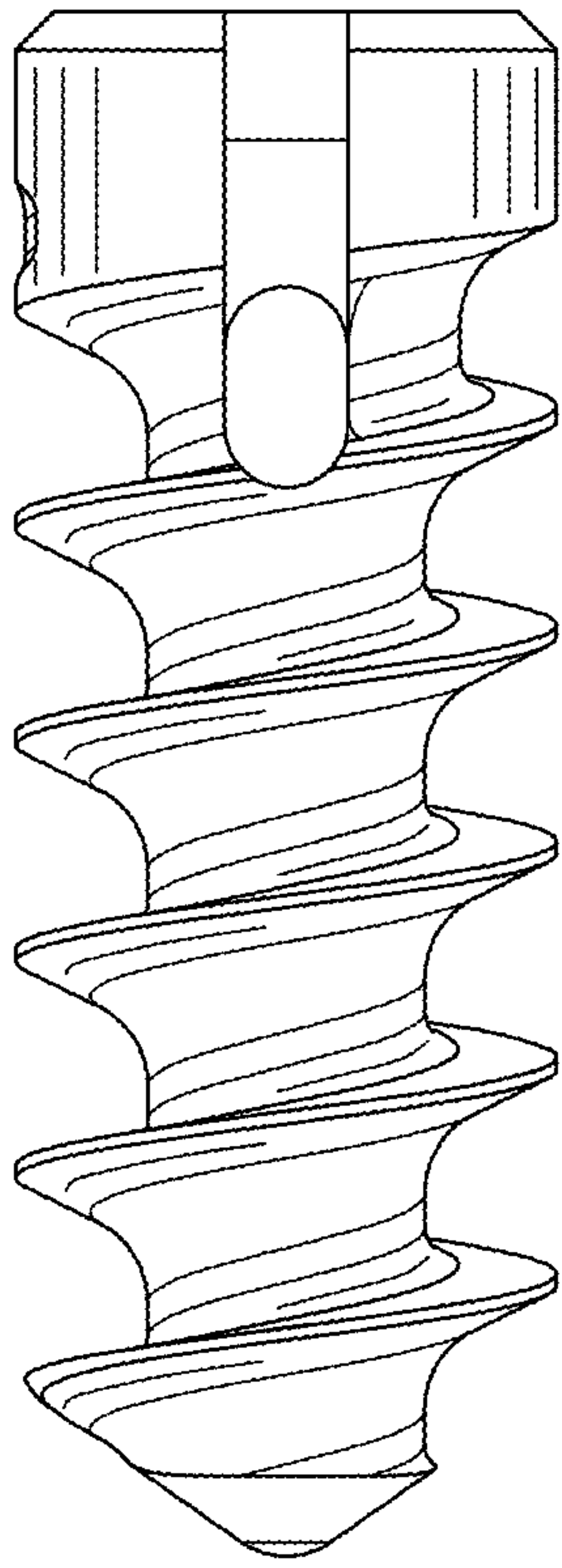

FIG. 3

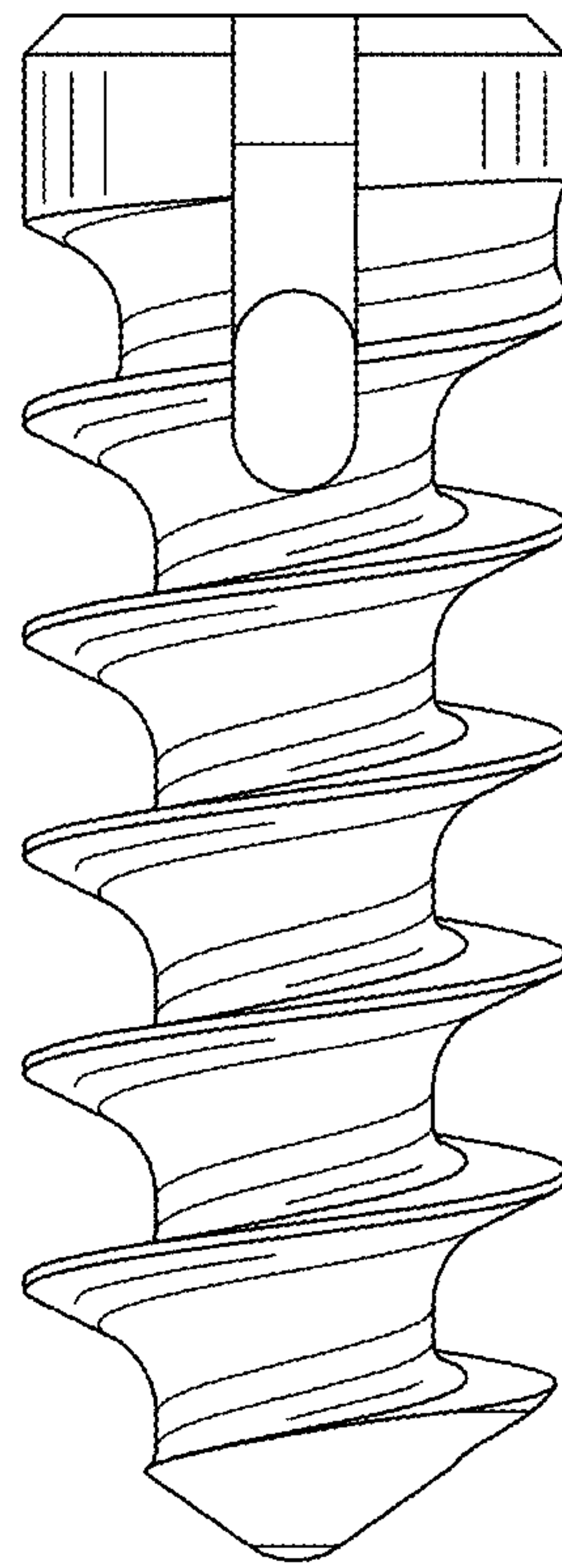

FIG. 4

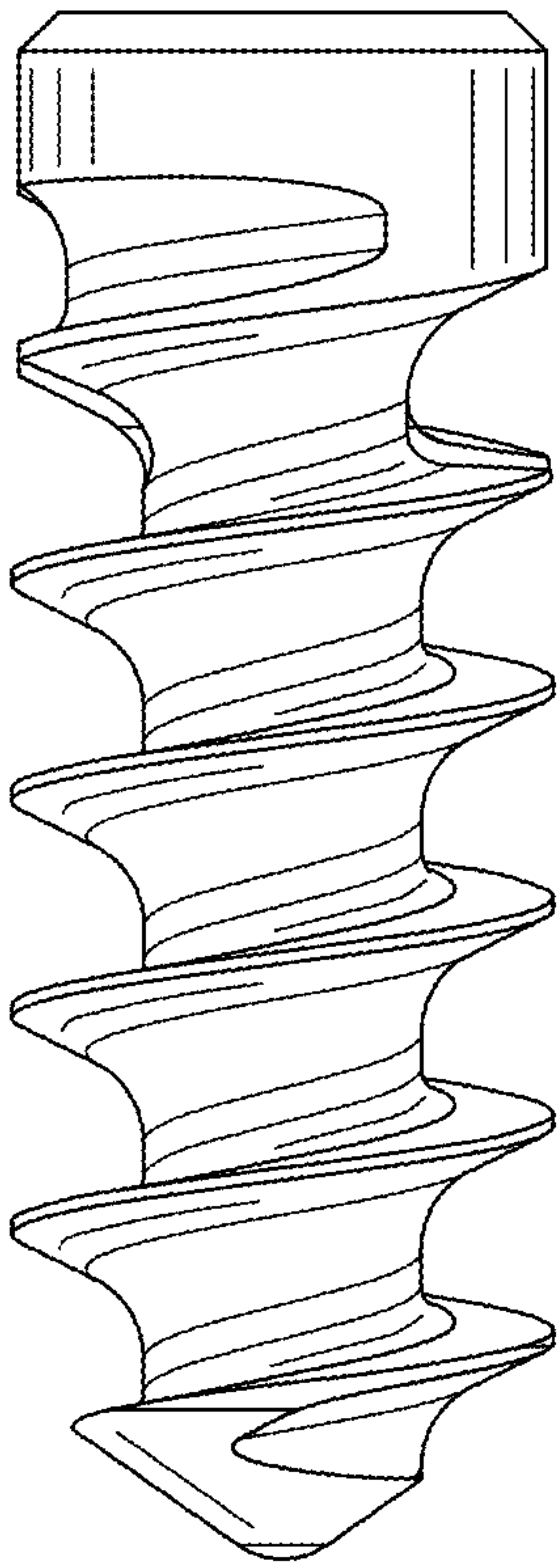

FIG. 5

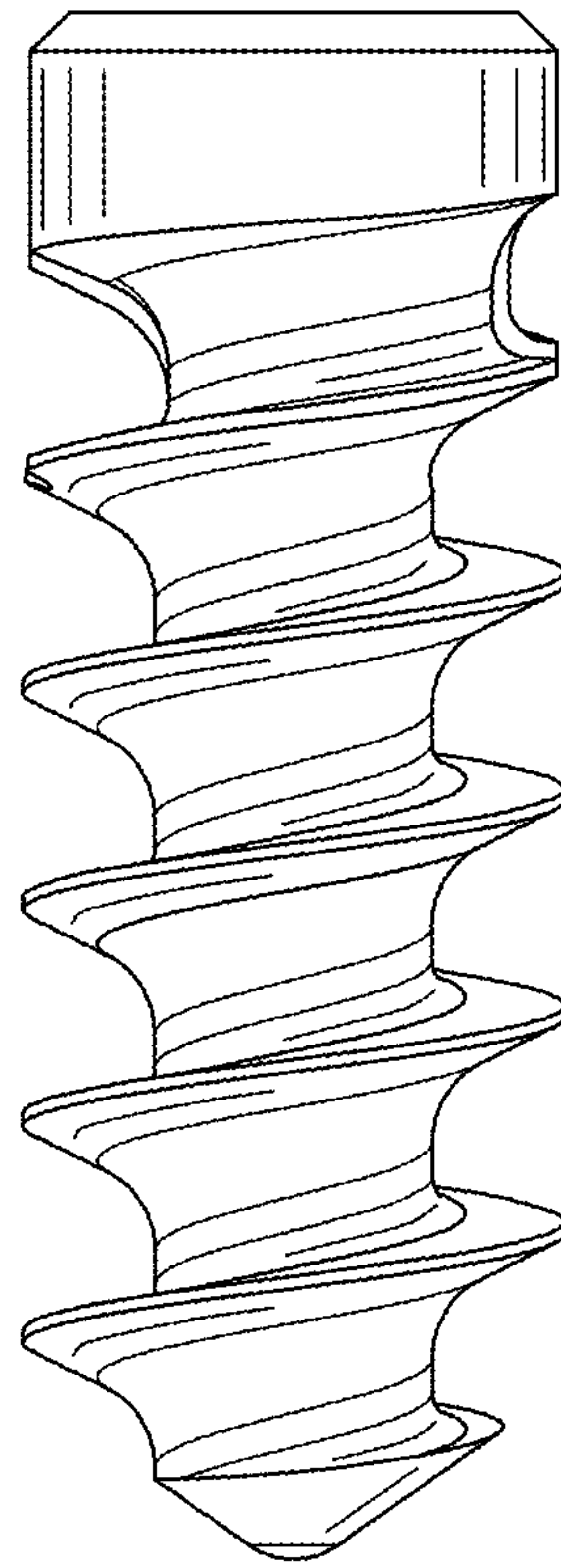

FIG. 6

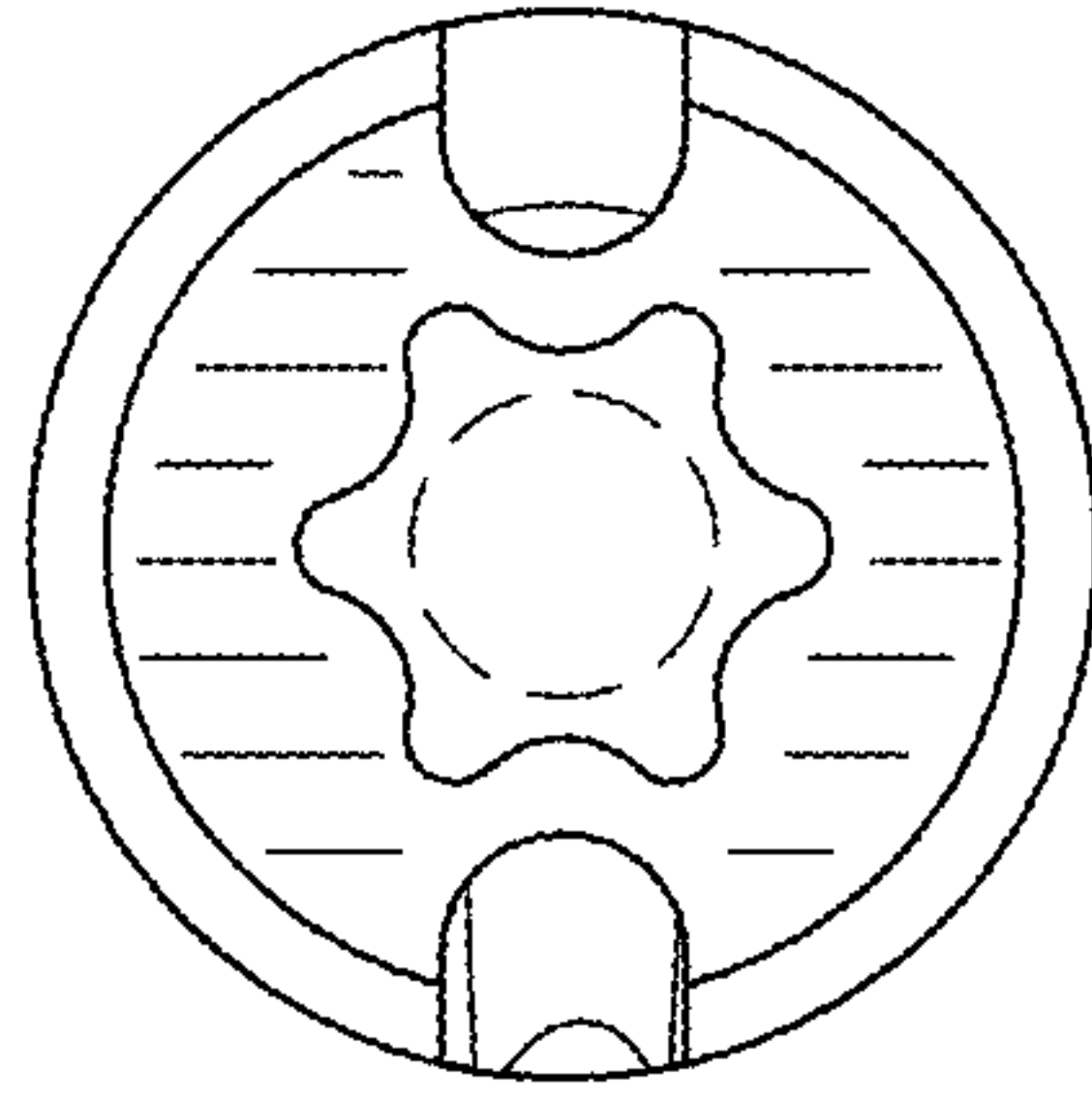

FIG. 7

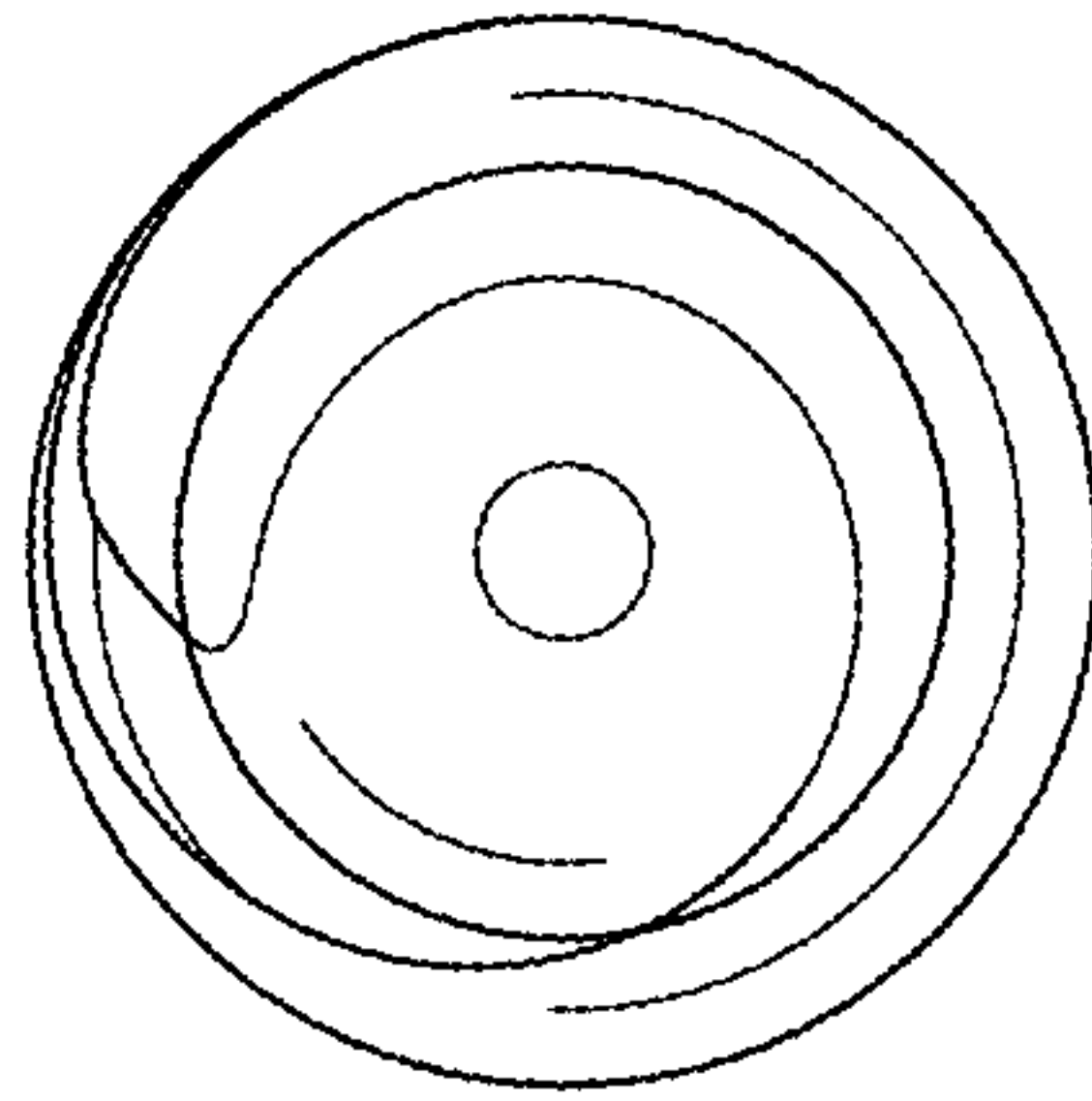

FIG. 8

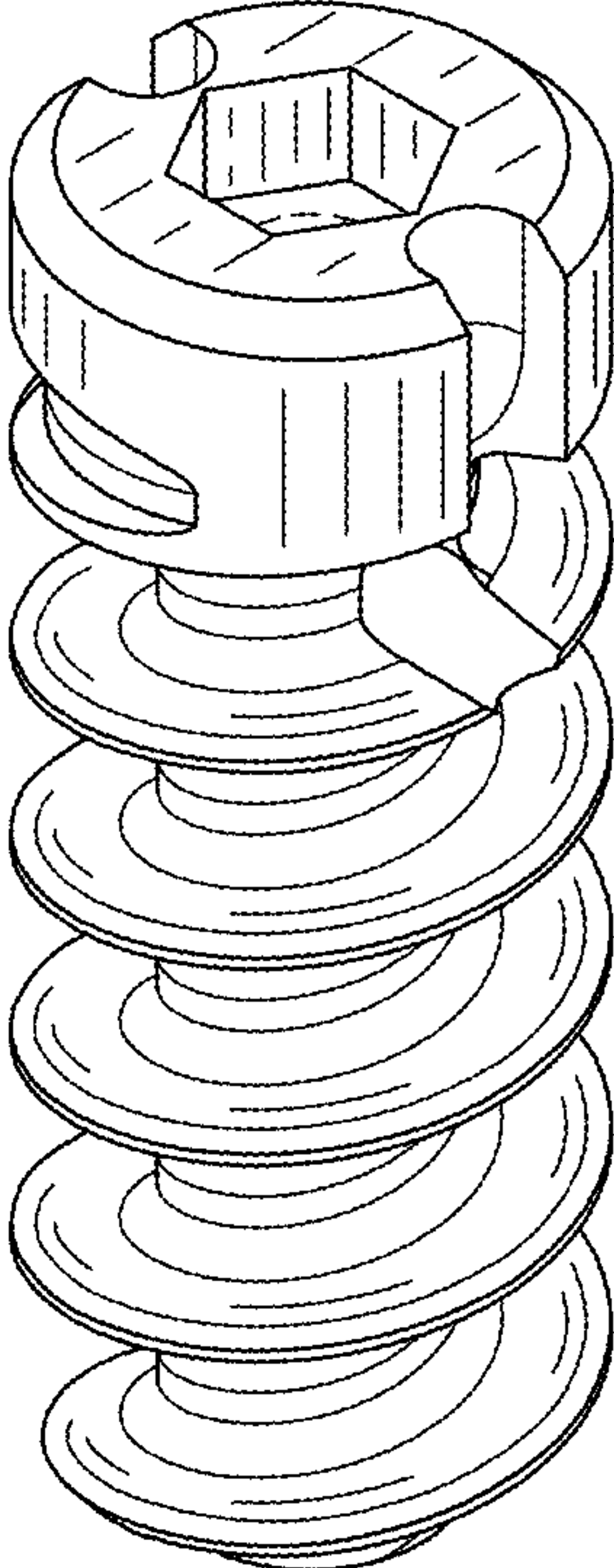

FIG. 9

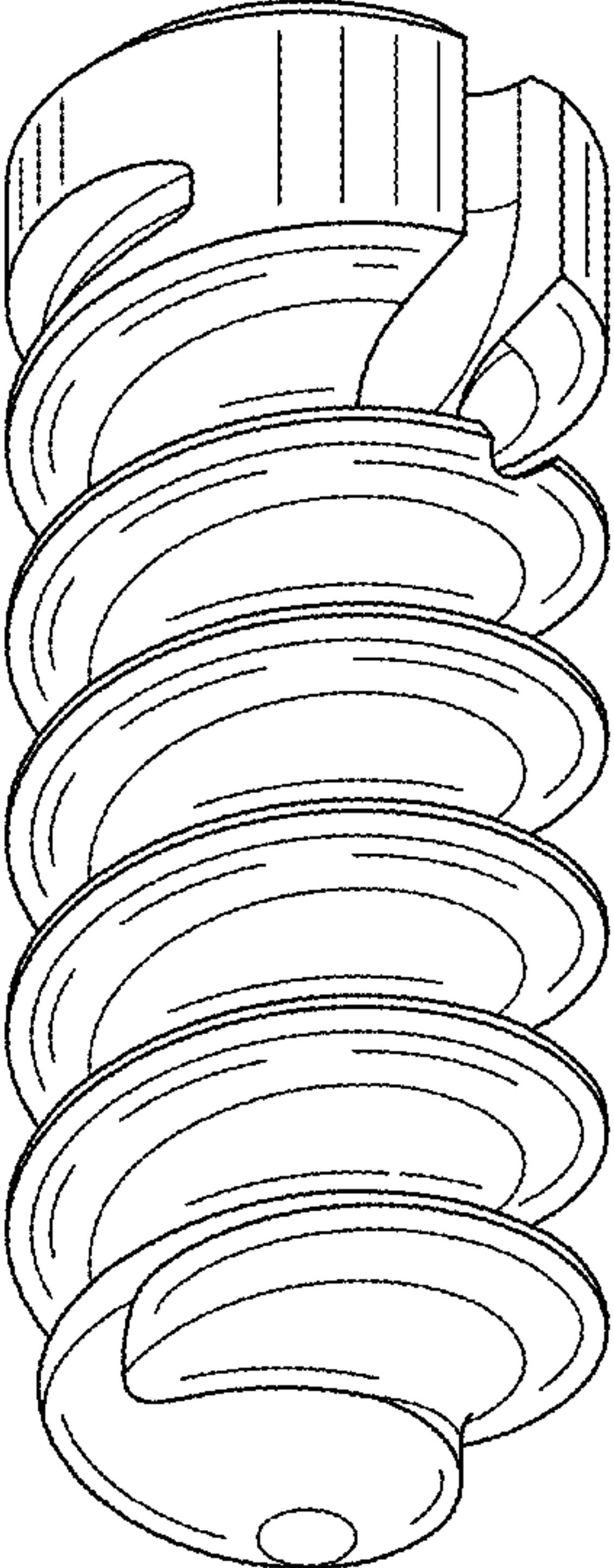

FIG. 10

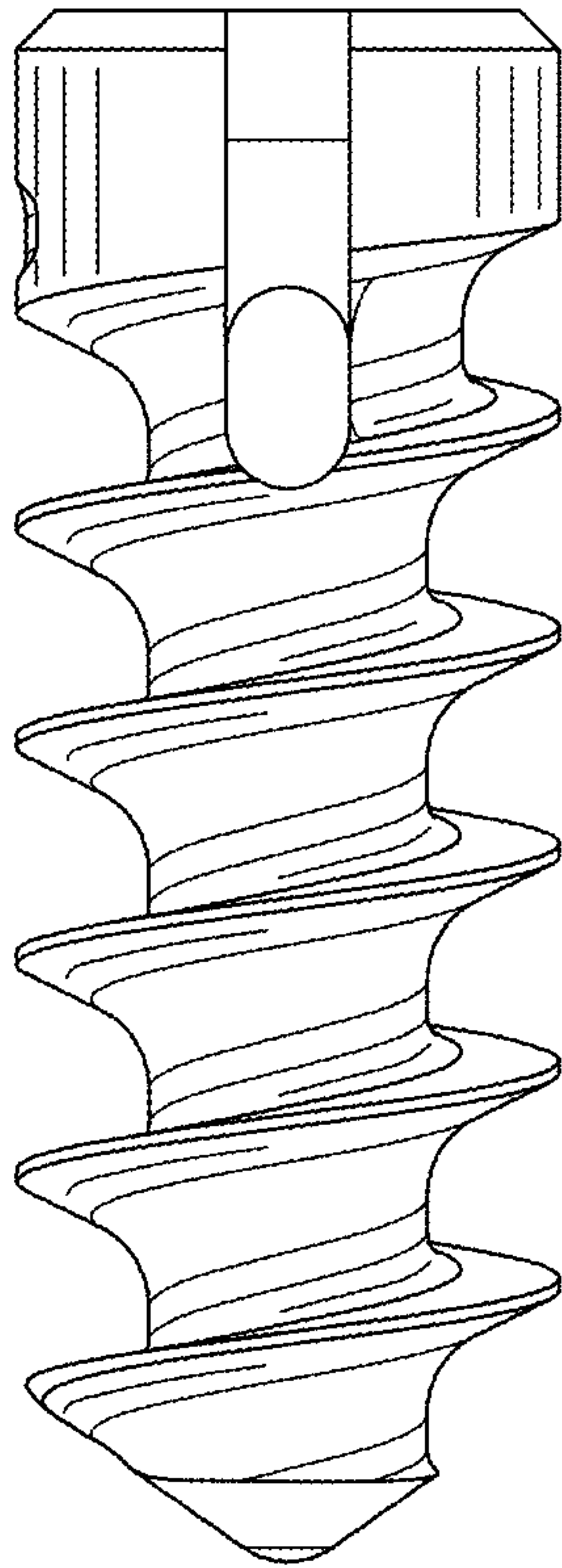

FIG. 11

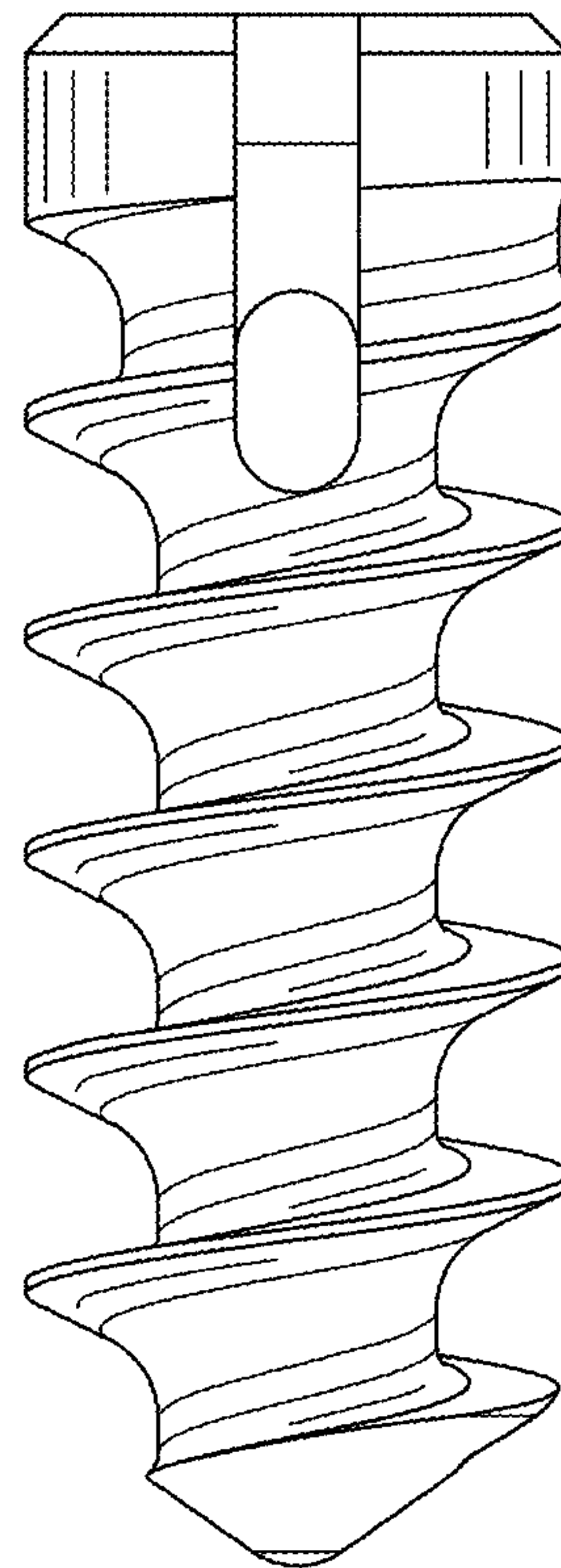

FIG. 12

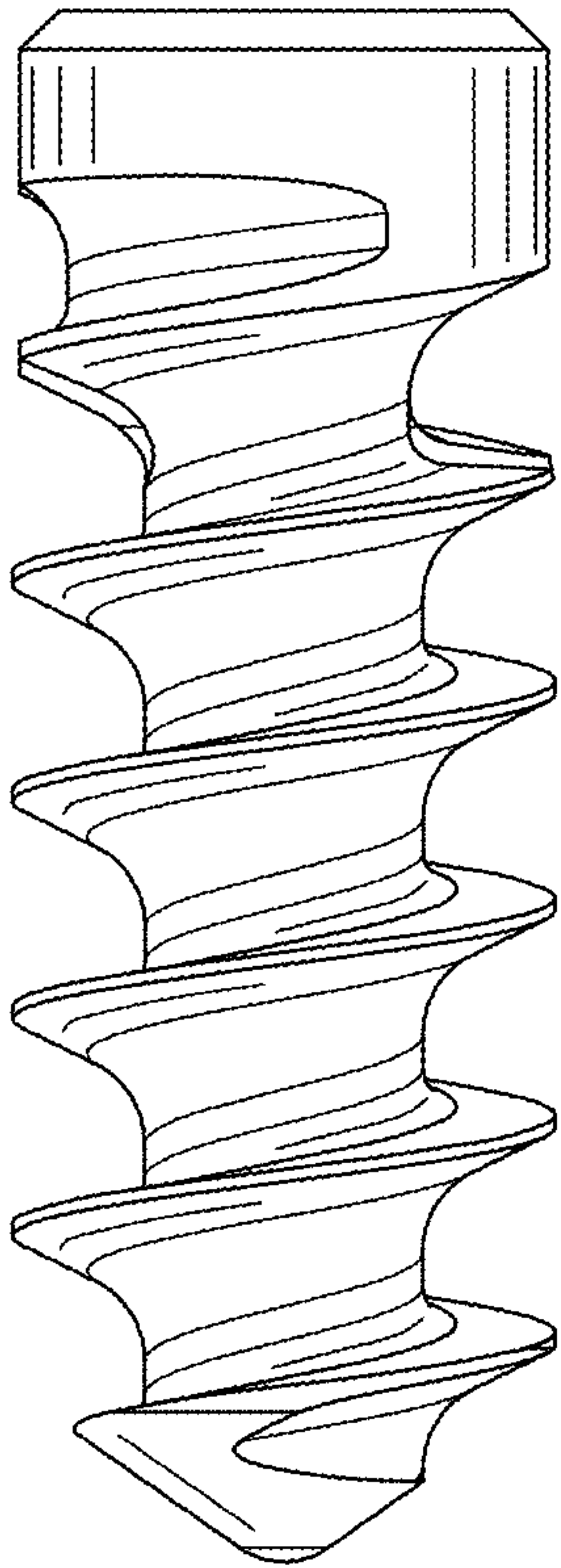

FIG. 13

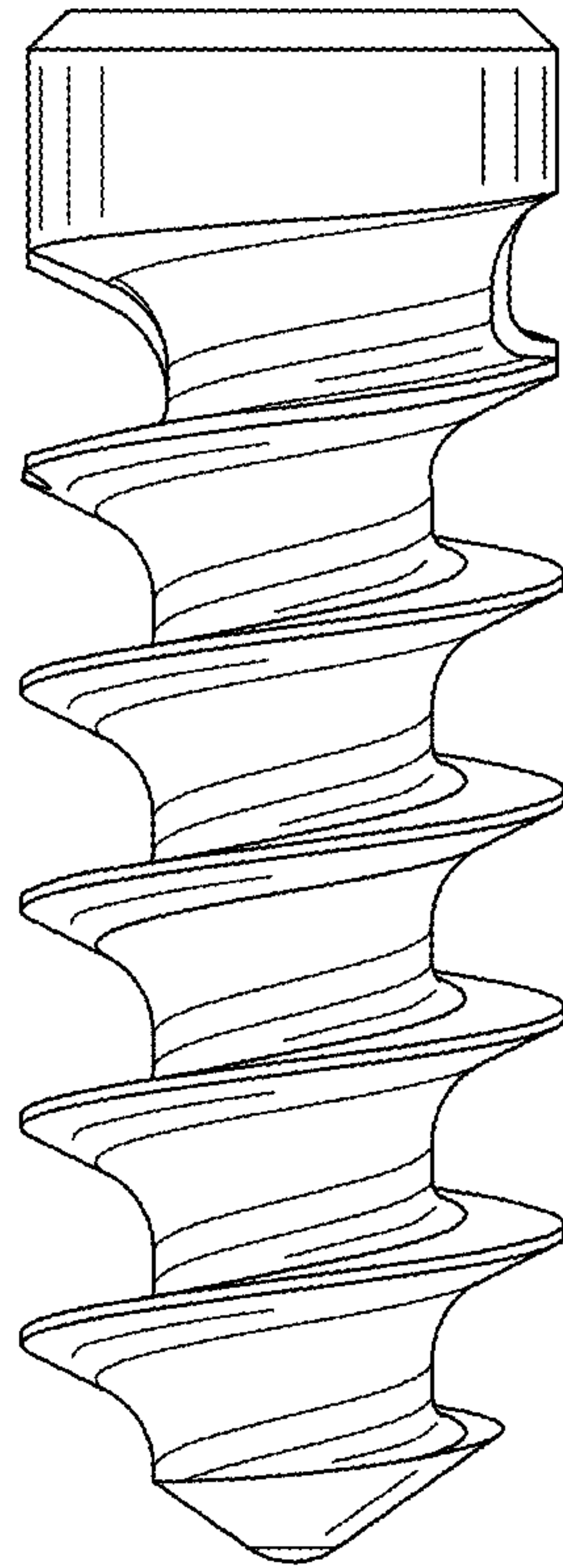

FIG. 14

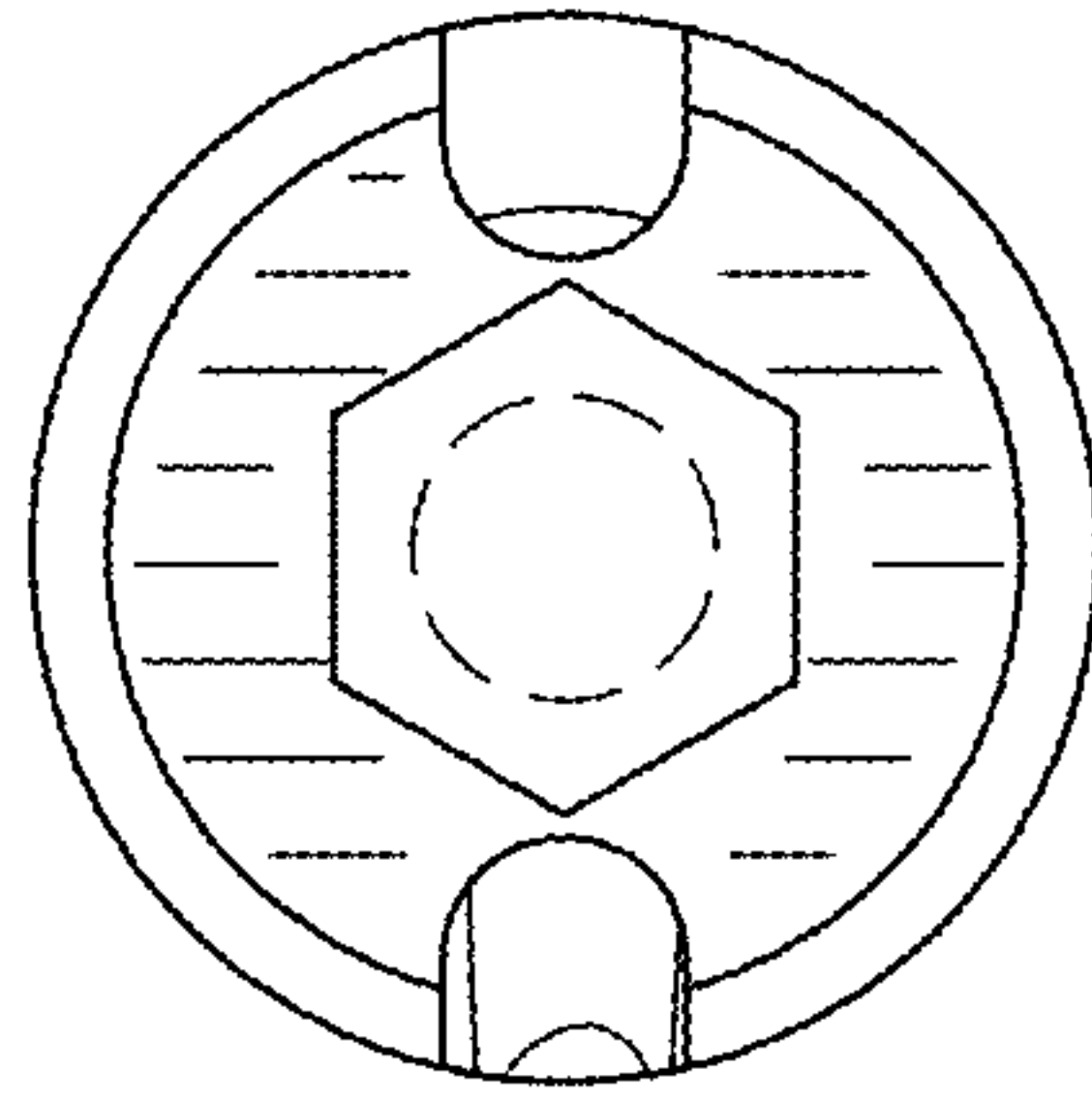

FIG. 15

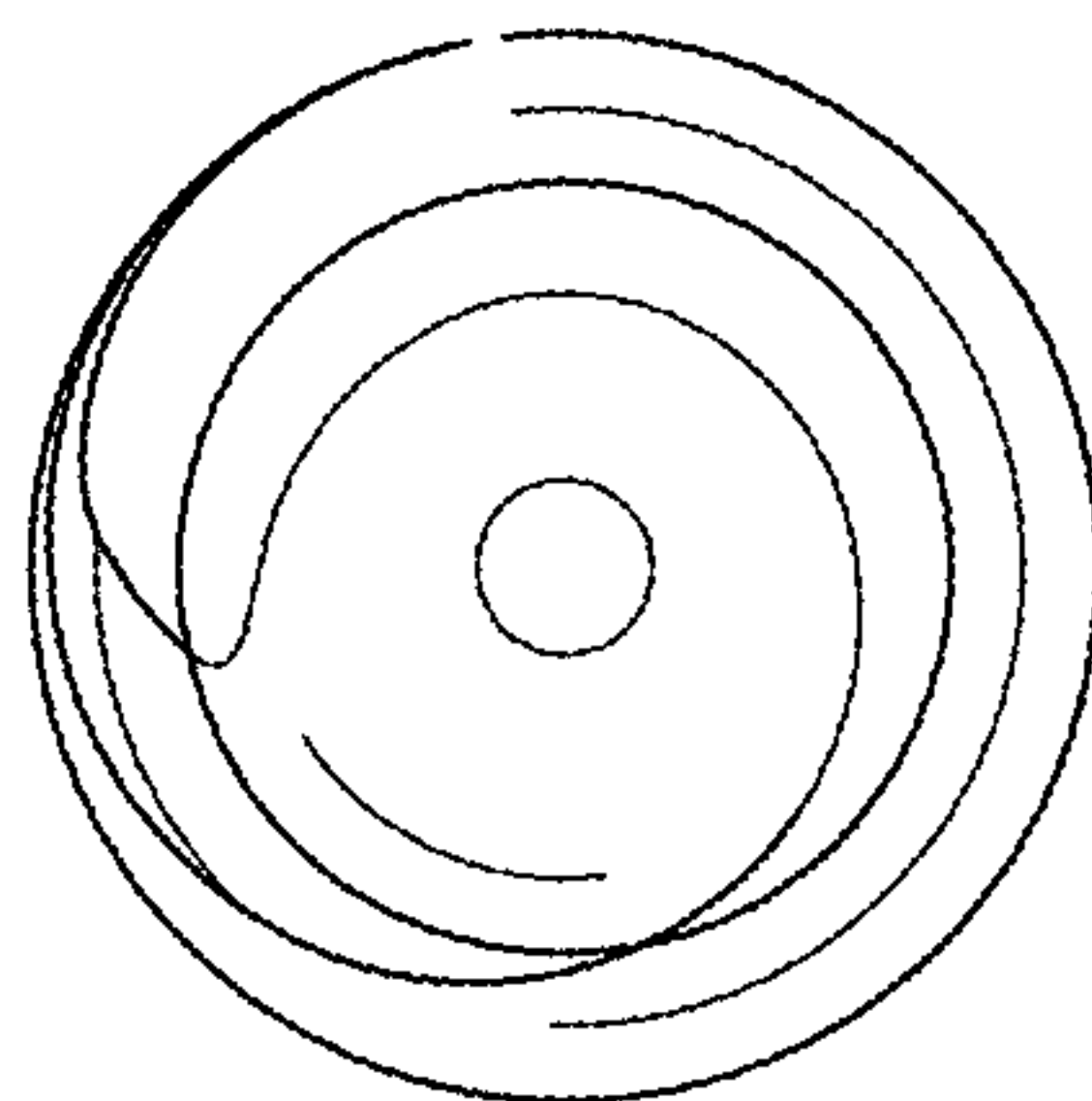

FIG. 16

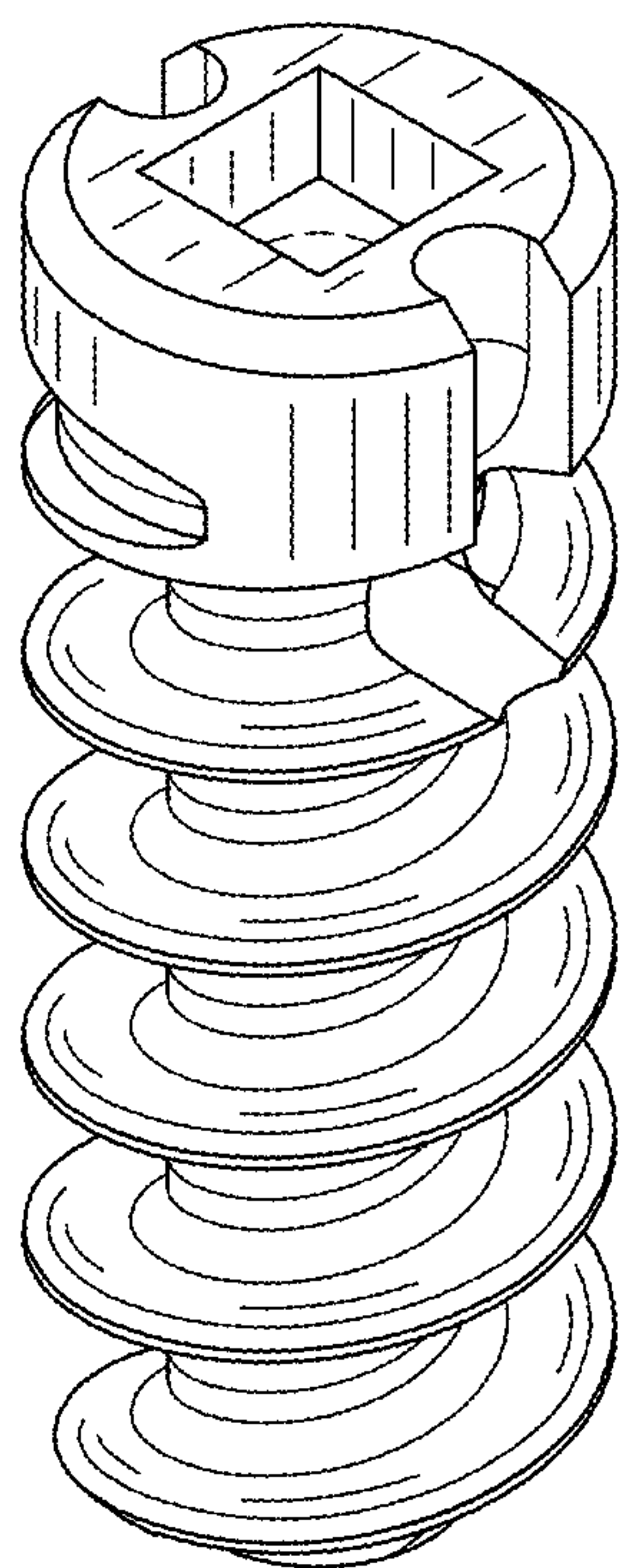

FIG. 17

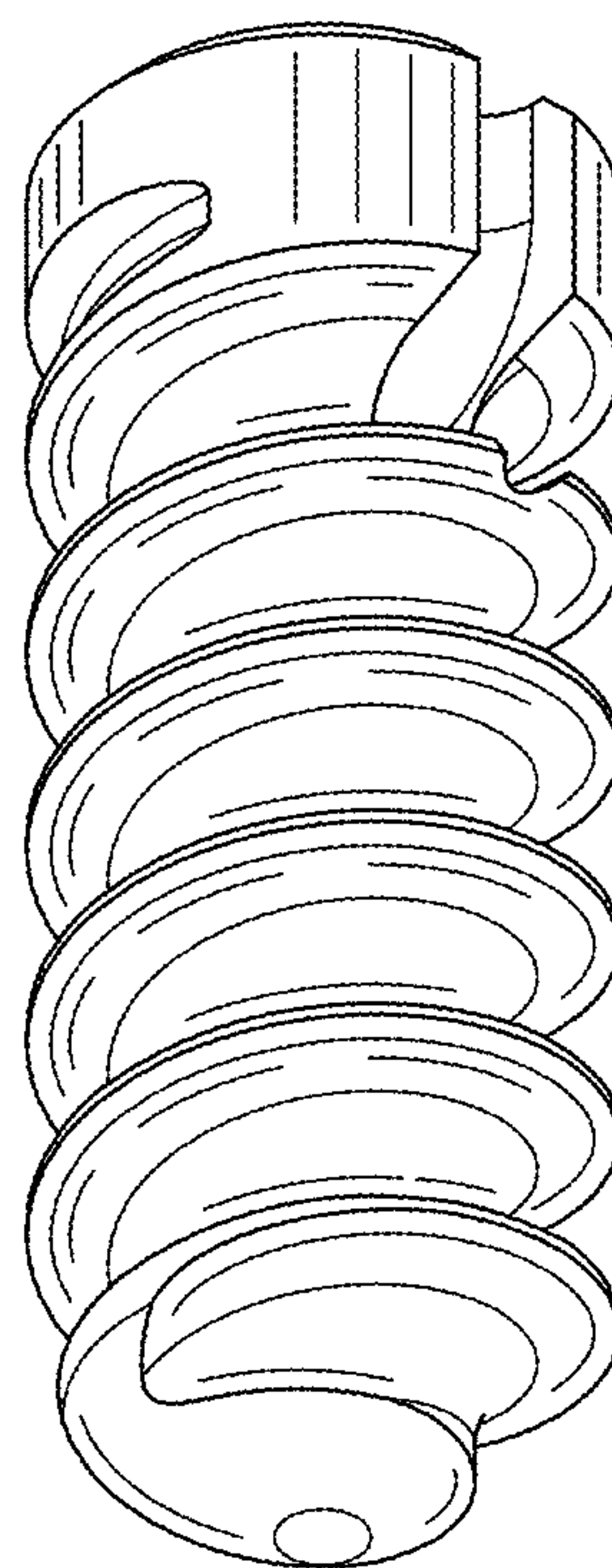

FIG. 18

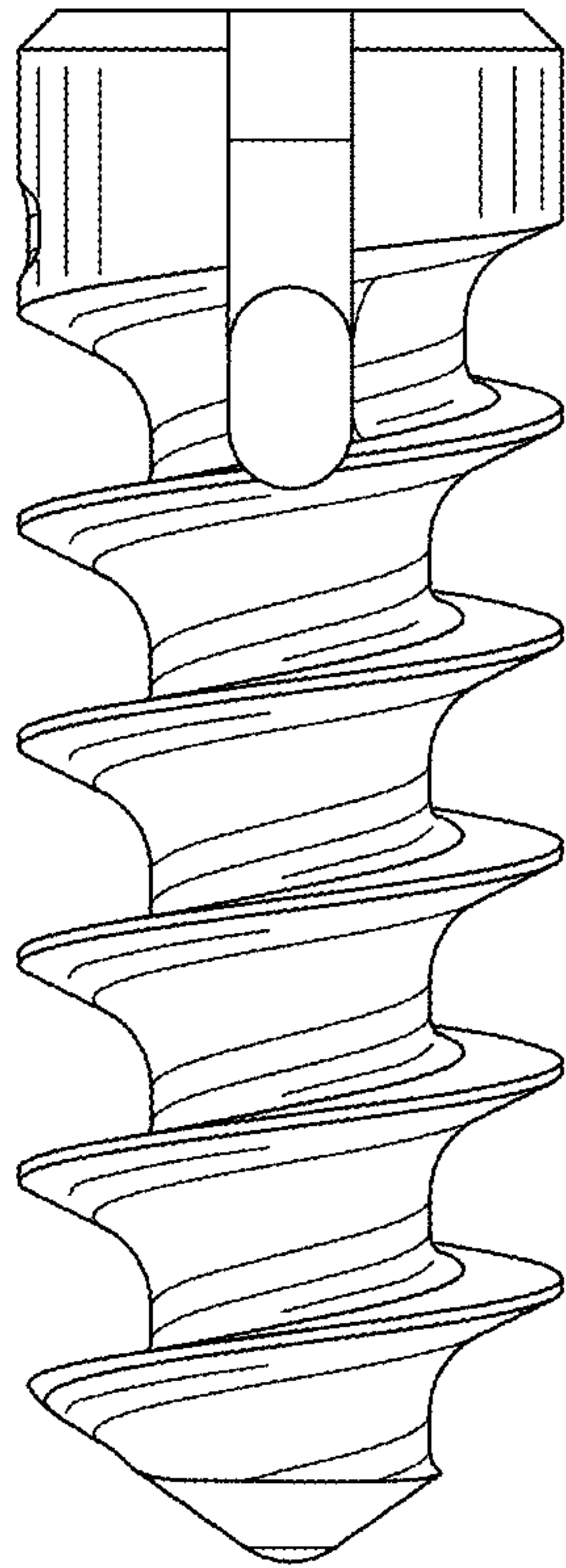

FIG. 19

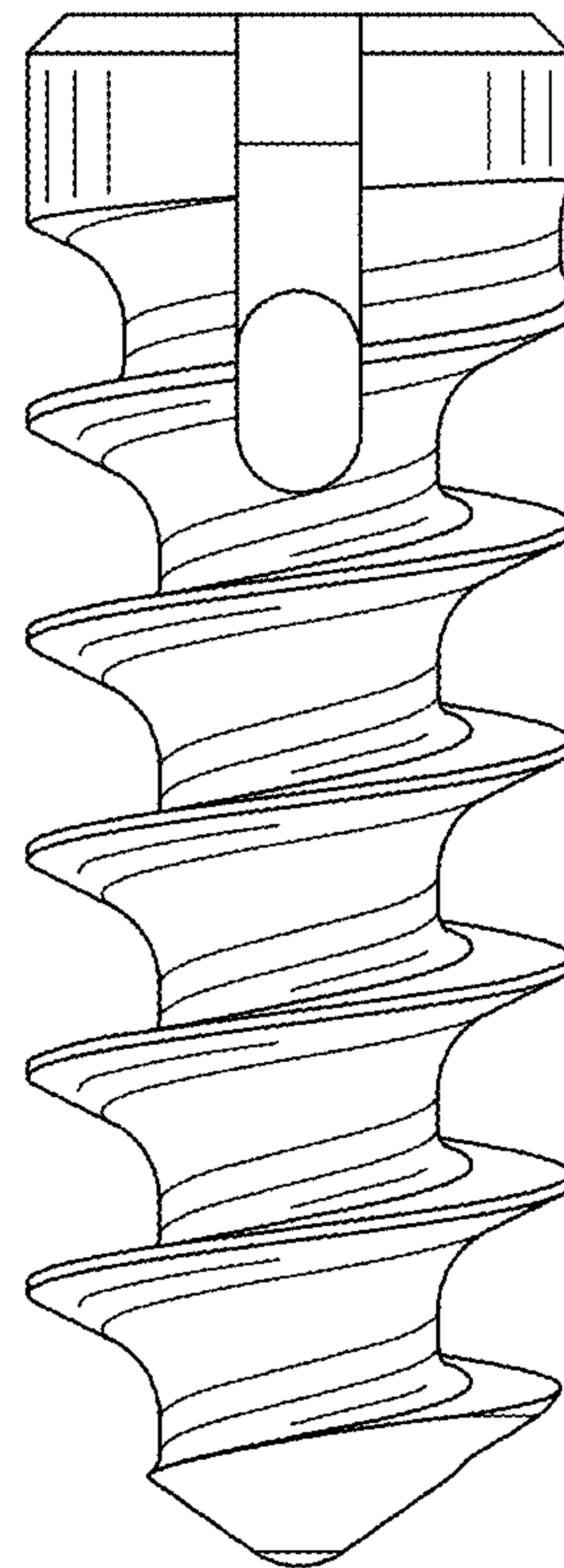

FIG. 20

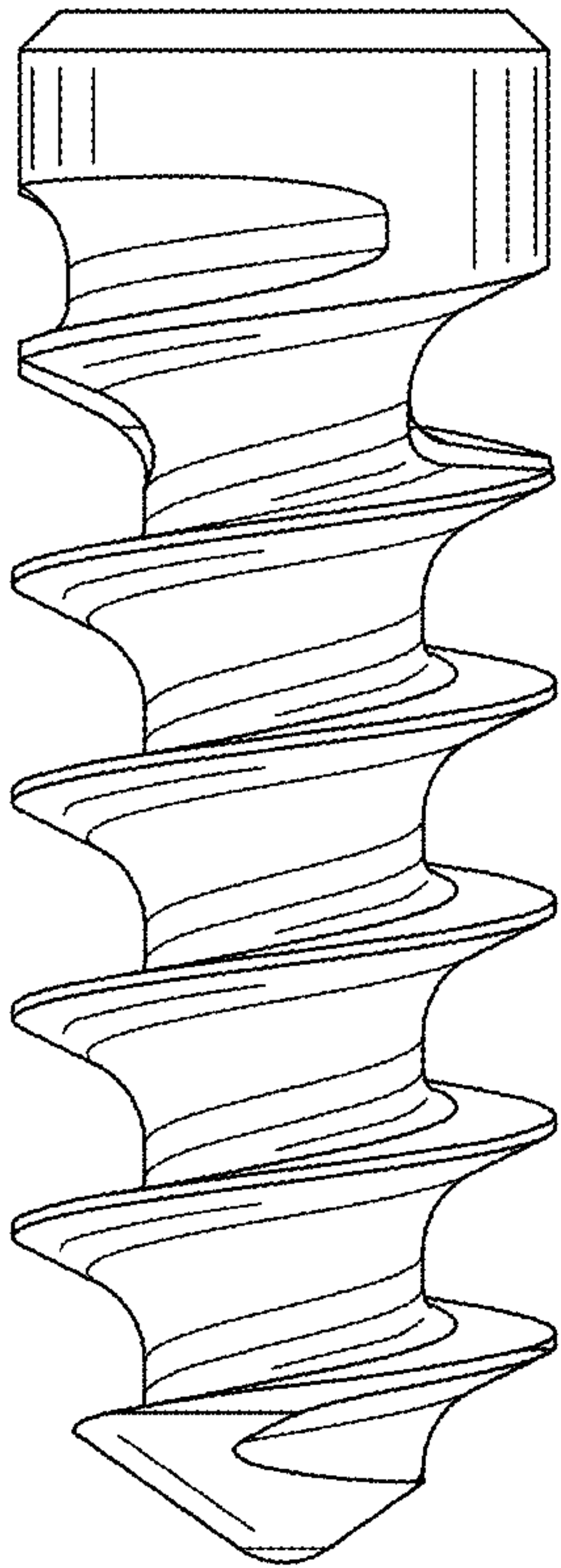

FIG. 21

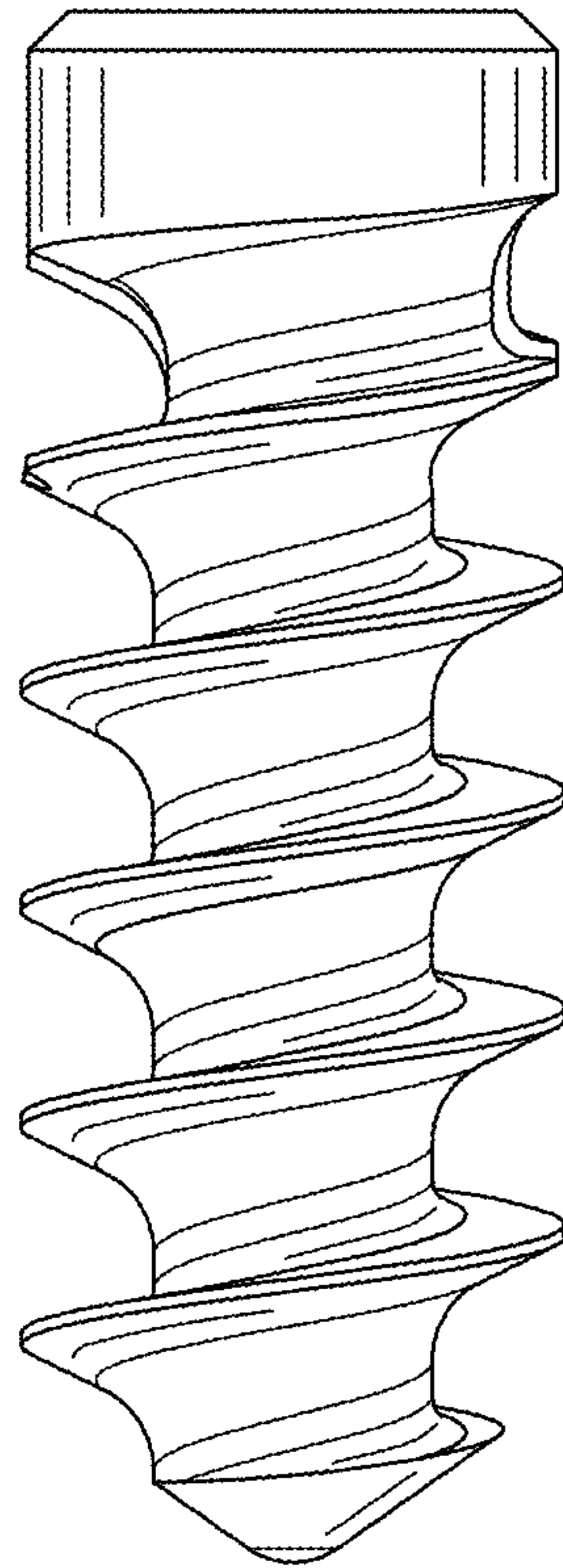

FIG. 22

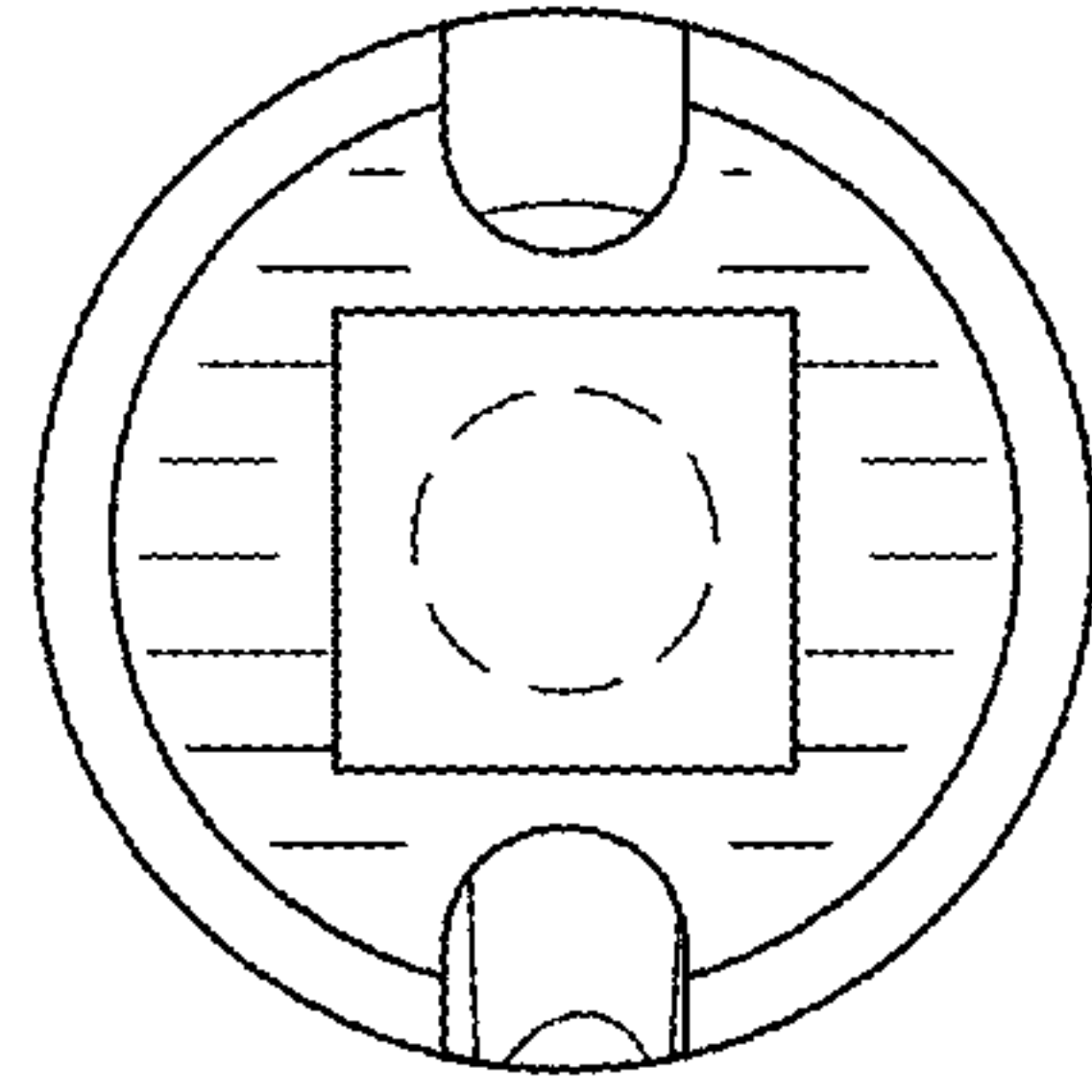

FIG. 23

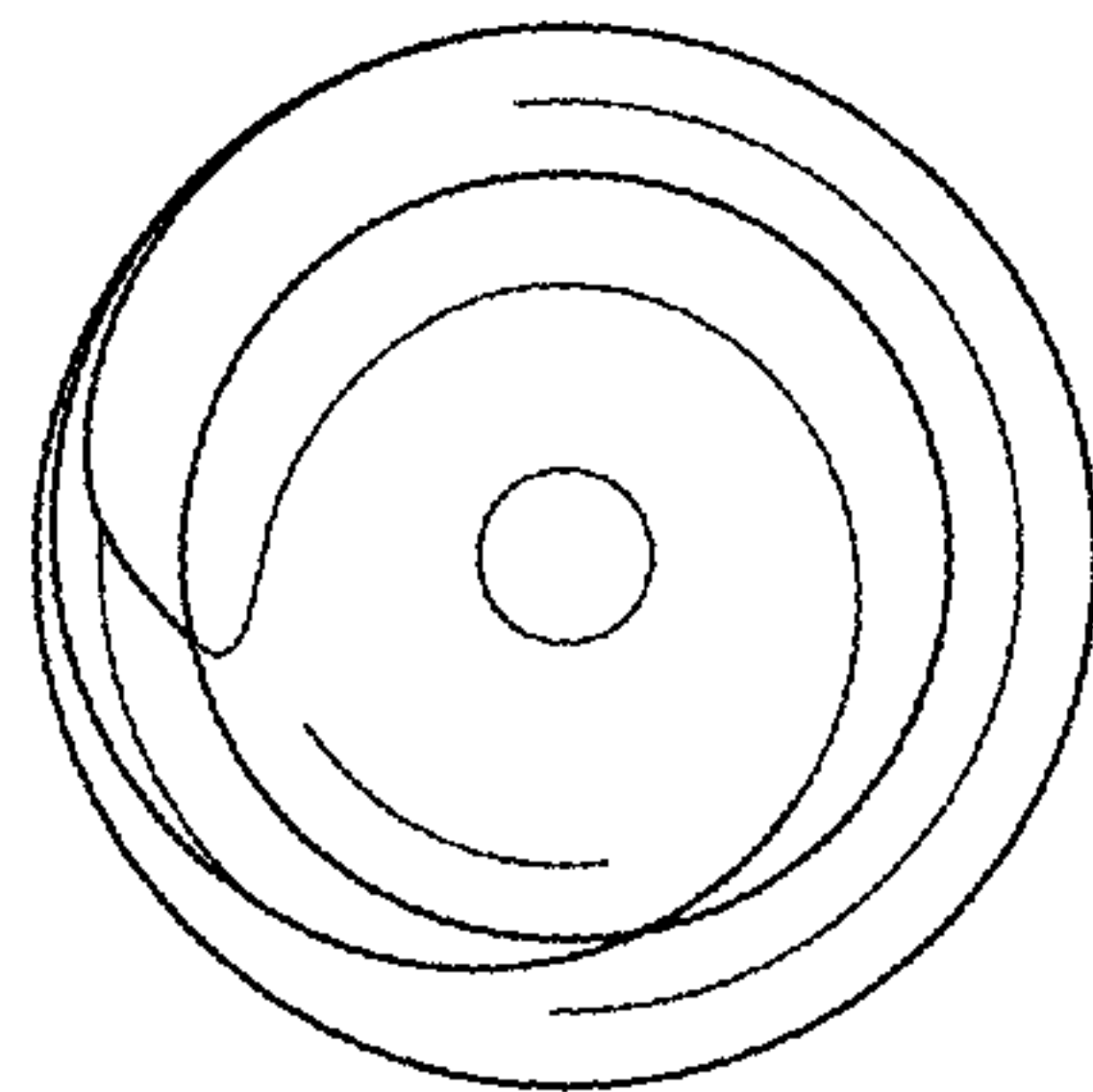

FIG. 24