



US00D979030S

(12) **United States Design Patent** (10) **Patent No.:** **US D979,030 S**  
**Tian** (45) **Date of Patent:** **\*\* Feb. 21, 2023**

(54) **AIR PURIFIER**  
(71) Applicant: **Guangzhou Tianzhi Innovation Technology Co., LTD**, Guangdong (CN)  
(72) Inventor: **Xin Tian**, Guangdong (CN)  
(\*\*) Term: **15 Years**  
(21) Appl. No.: **29/857,203**  
(22) Filed: **Oct. 20, 2022**  
(51) **LOC (14) Cl.** ..... **23-04**  
(52) **U.S. Cl.**  
USPC ..... **D23/364**  
(58) **Field of Classification Search**  
USPC ..... D23/355-366, 352, 369, 332, 333, 335, D23/336, 342, 351  
CPC .. A61L 9/16; A61L 9/22; B01D 47/00; B01D 47/027; B01D 2221/02; B01D 2259/4508; B03C 3/155; B03C 3/368; F24F 3/16; F24F 13/20; F24F 13/28  
See application file for complete search history.

D912,795 S \* 3/2021 Wang ..... D23/364  
D919,064 S \* 5/2021 Wang ..... D23/356  
D925,716 S \* 7/2021 Qin ..... D23/356  
D935,591 S \* 11/2021 Xu ..... D23/364  
D938,566 S \* 12/2021 Yang ..... D23/364  
D947,343 S \* 3/2022 Xia ..... D23/364  
D948,010 S \* 4/2022 Xu ..... D23/356  
D950,034 S 4/2022 Peng  
D951,412 S \* 5/2022 Han ..... D23/364  
D954,242 S 6/2022 Yan  
D963,822 S 9/2022 Wang  
D964,534 S 9/2022 Yu  
D965,759 S 10/2022 Liu  
D967,370 S 10/2022 Han et al.  
D967,373 S 10/2022 Han et al.

\* cited by examiner

*Primary Examiner* — David G Muller  
(74) *Attorney, Agent, or Firm* — SciNova IP and Regulatory Consulting LLC; Jingfeng Song

(57) **CLAIM**

The ornamental design for air purifier, as shown and described.

**DESCRIPTION**

FIG. 1 is a front, right, and top perspective view of an air purifier, showing my new design;  
FIG. 2 is a rear, left, and bottom perspective view thereof;  
FIG. 3 is a front elevational view thereof;  
FIG. 4 is a rear elevational view thereof;  
FIG. 5 is a left elevational view thereof;  
FIG. 6 is a right elevational view thereof;  
FIG. 7 is a top plan view thereof; and,  
FIG. 8 is a bottom plan view thereof.  
The broken lines depict portions of air purifier and form no part of the claimed design.

**1 Claim, 8 Drawing Sheets**

(56) **References Cited**

**U.S. PATENT DOCUMENTS**

D274,353 S \* 6/1984 Hoyle ..... D23/352  
D346,017 S \* 4/1994 Lim ..... D23/336  
D374,712 S \* 10/1996 Jane ..... D23/336  
D375,546 S \* 11/1996 Lee ..... D23/355  
D382,951 S \* 8/1997 Deines ..... D23/339  
D820,422 S \* 6/2018 Kim ..... D23/364  
D855,787 S \* 8/2019 Sakamoto ..... D23/370  
D870,873 S \* 12/2019 Chen ..... D23/356  
D896,937 S \* 9/2020 Yang ..... D23/335  
D899,571 S \* 10/2020 Li ..... D23/359  
D903,844 S \* 12/2020 Chen ..... D23/356  
D905,220 S \* 12/2020 Farone ..... D23/364

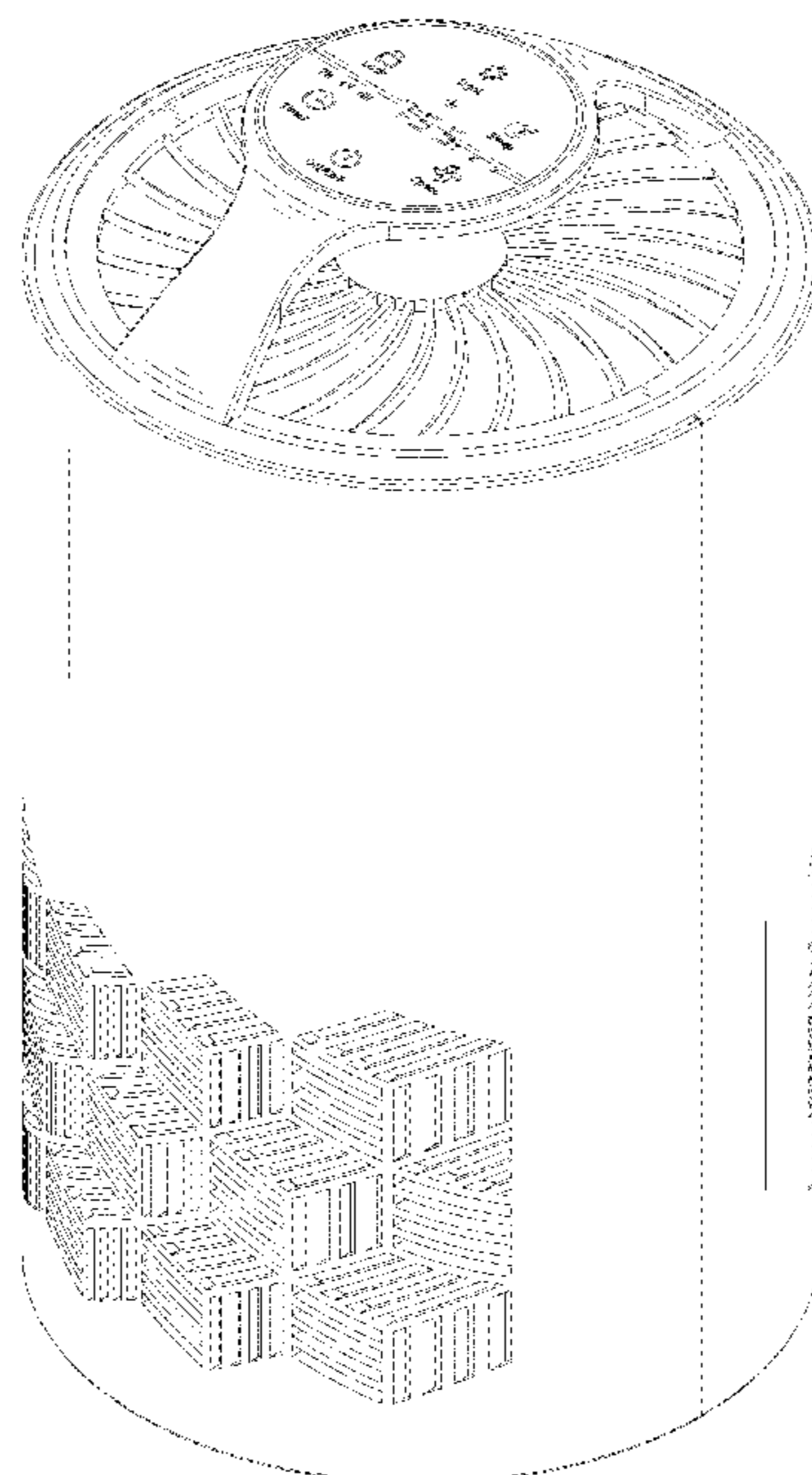

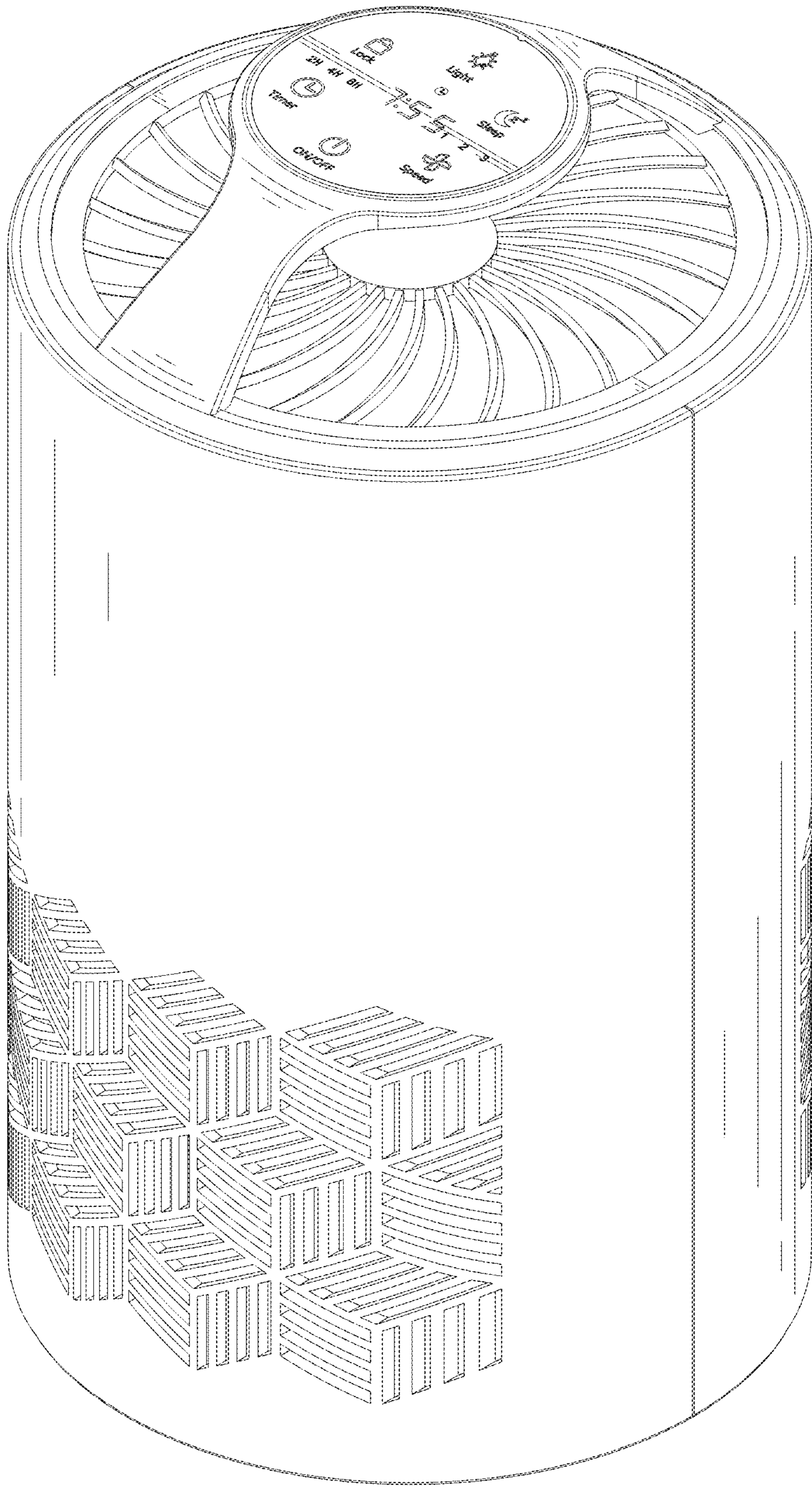

FIG.1

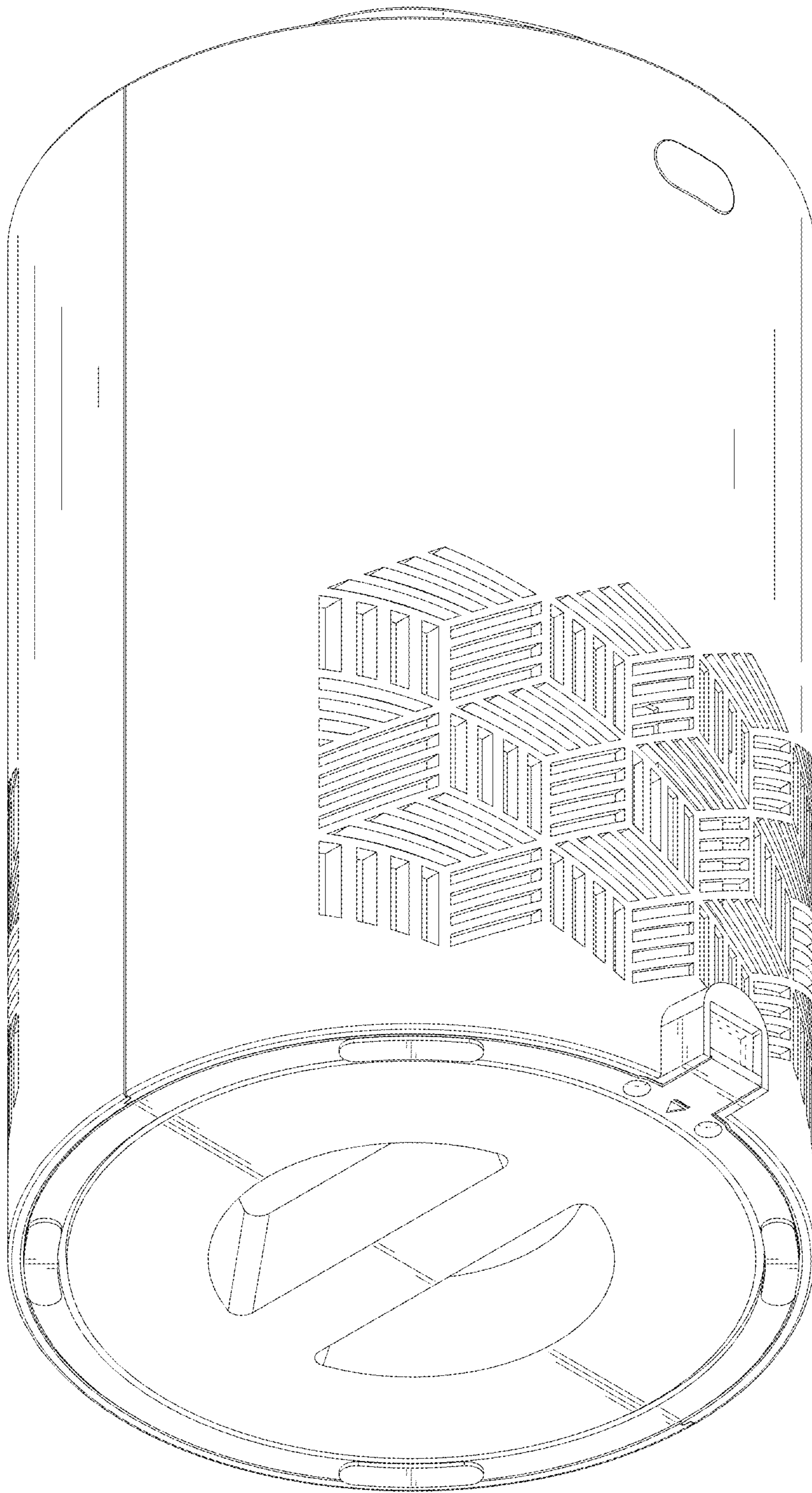

FIG.2

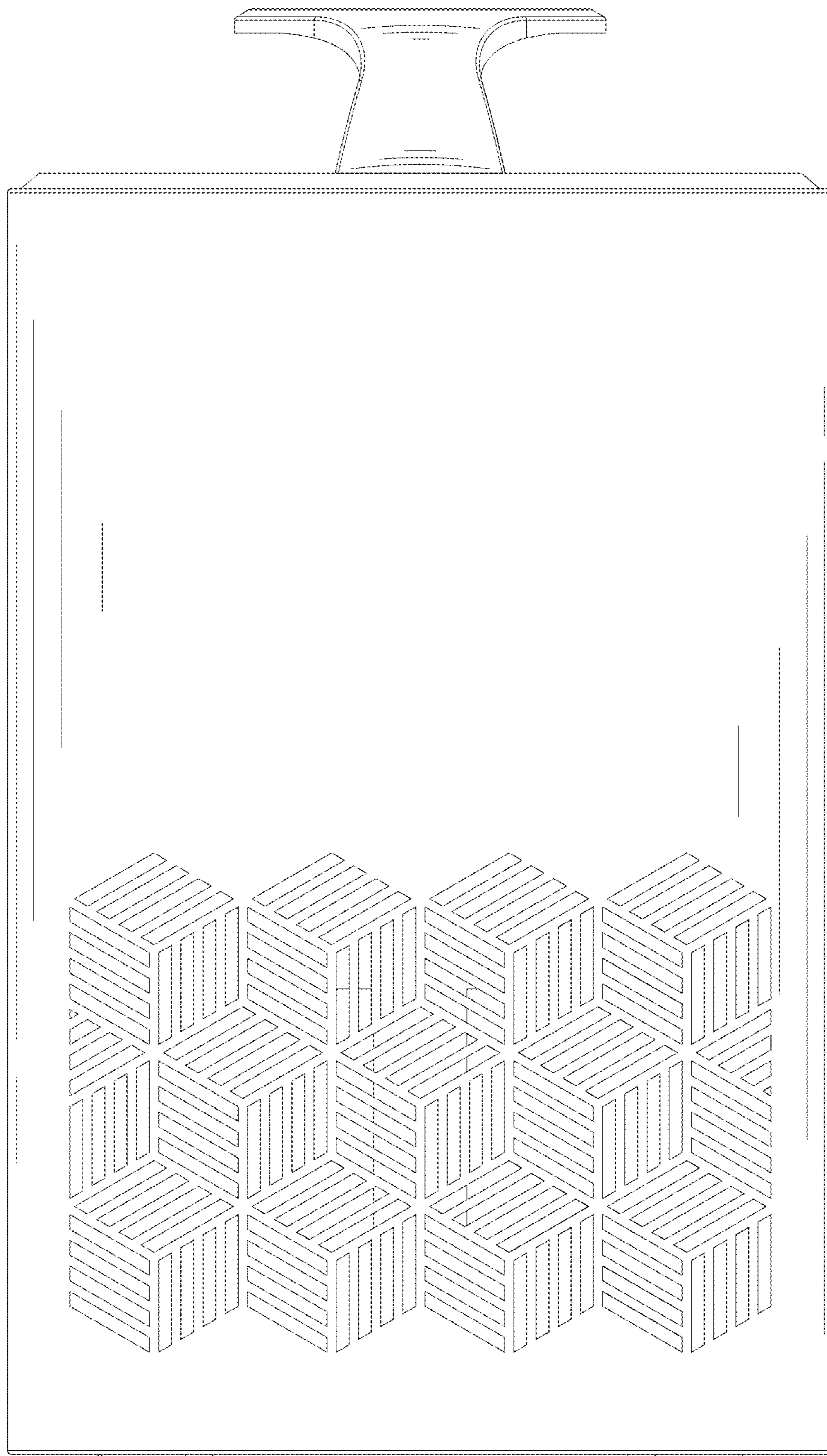

FIG.3

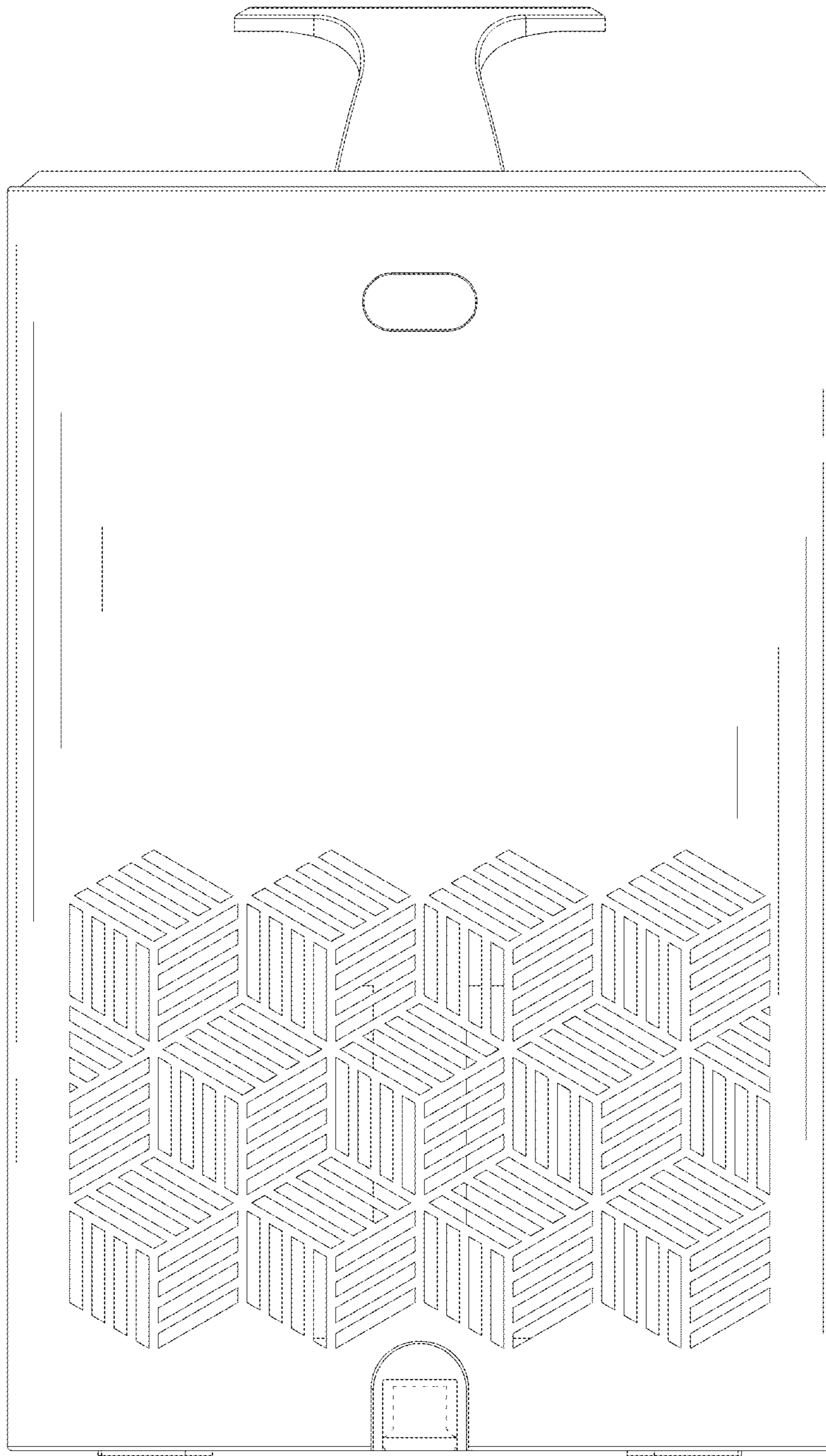

FIG. 4

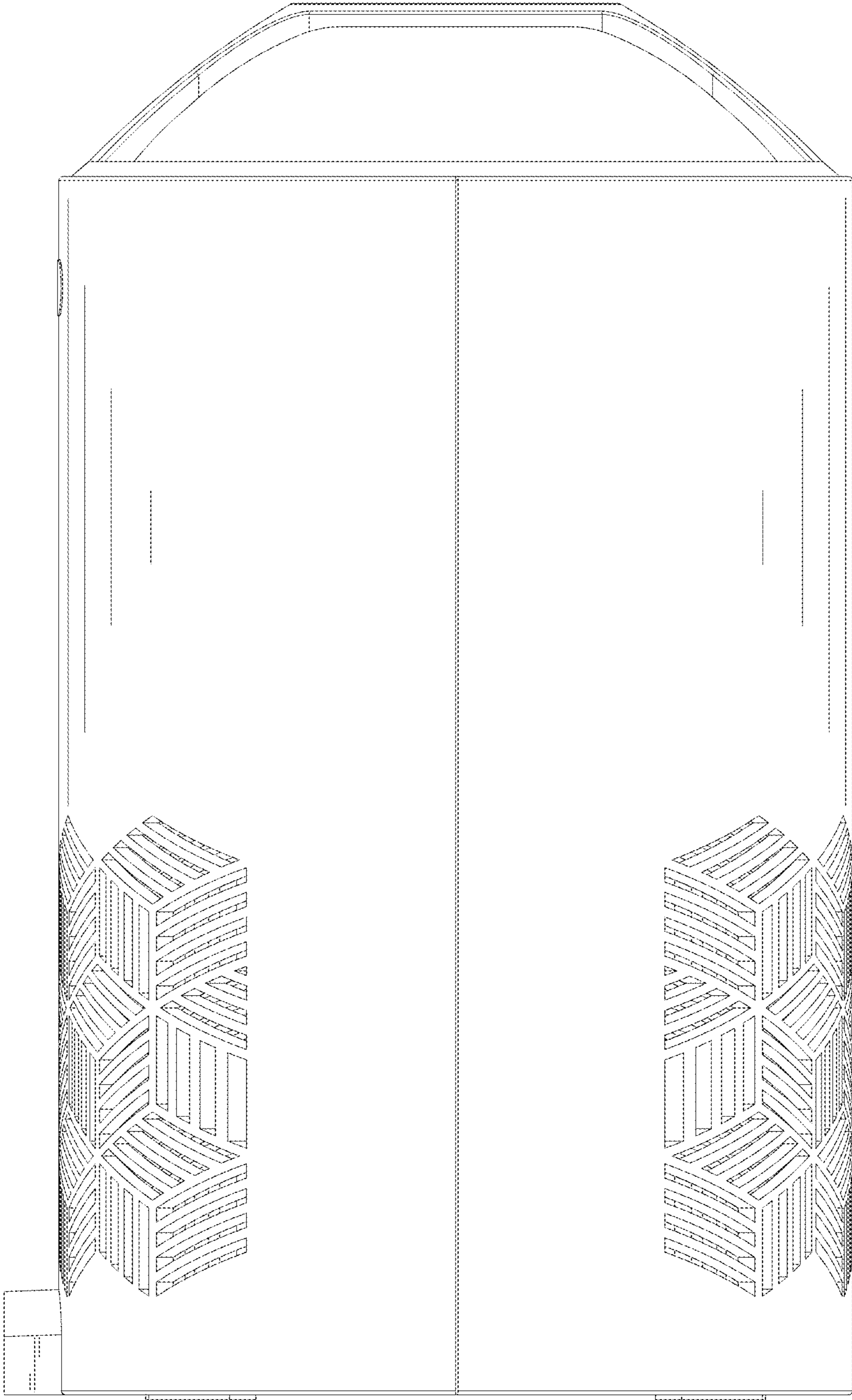

FIG.5

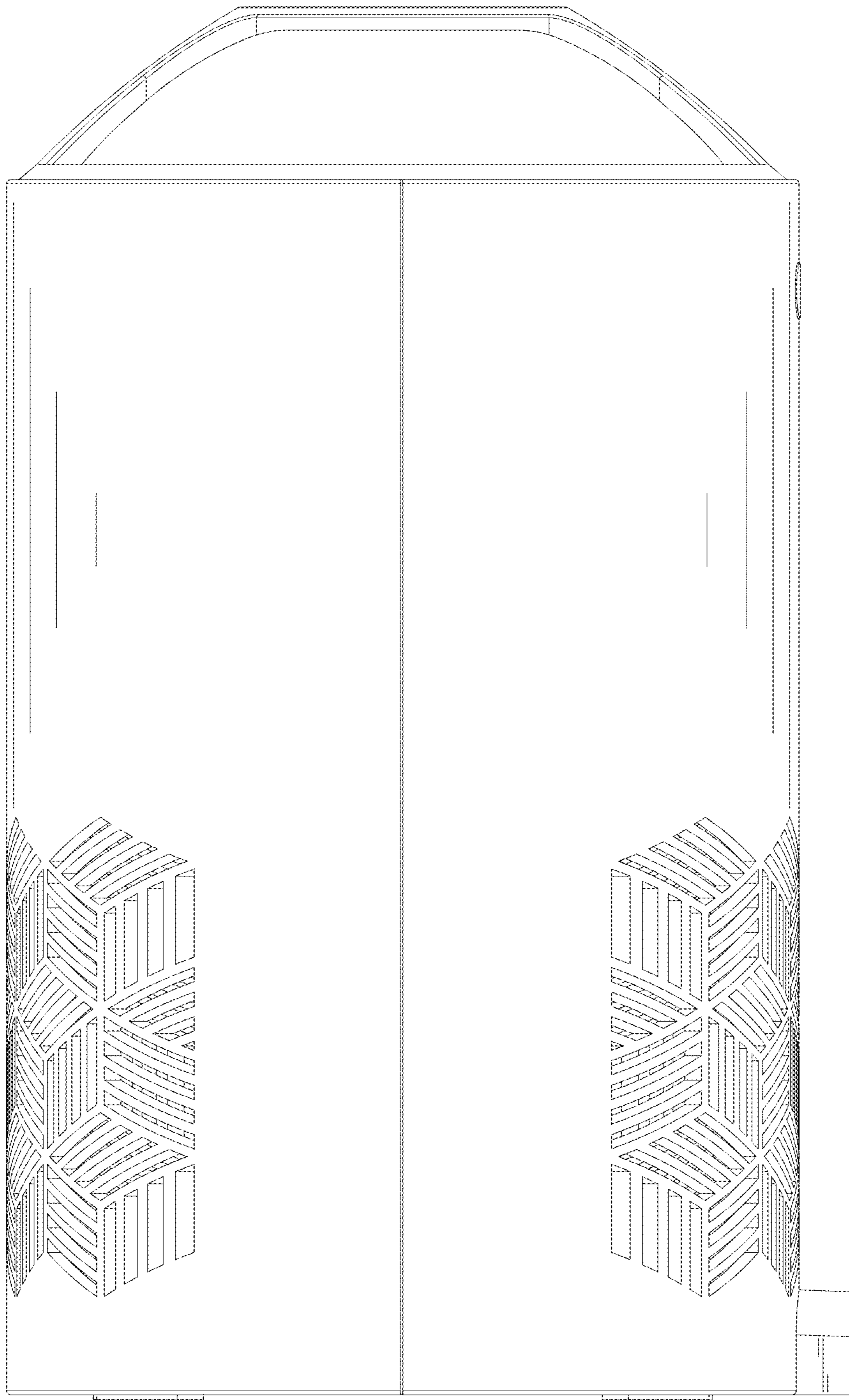

FIG. 6

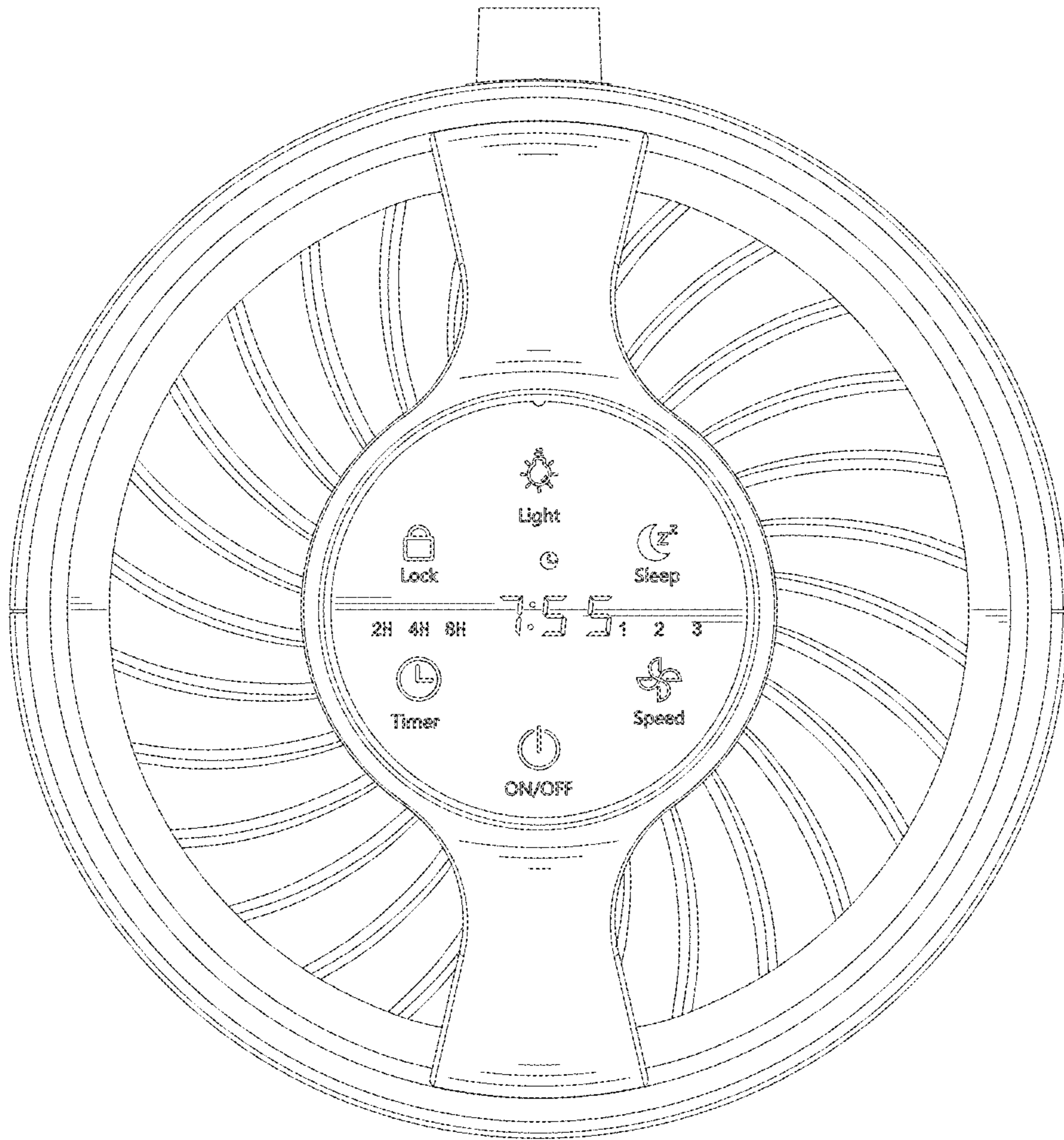

FIG.7



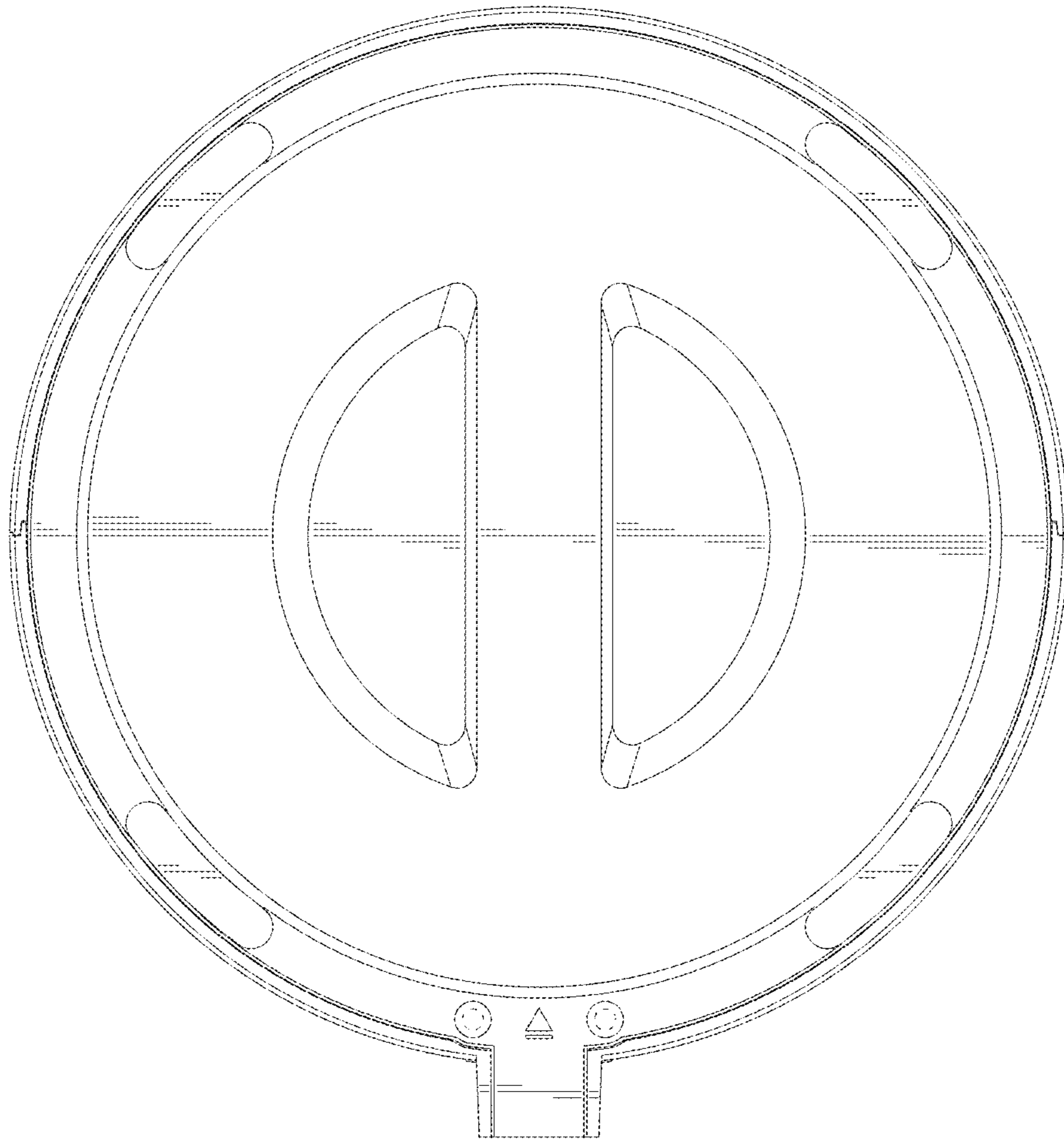

FIG.8