

US00D979011S

(12) **United States Design Patent** (10) **Patent No.:** **US D979,011 S**
Johnson, Jr. (45) **Date of Patent:** **** Feb. 21, 2023**

(54) **FISHING GIMBAL**

(71) Applicant: **William A. Johnson, Jr.**, Pine Mountain, GA (US)

(72) Inventor: **William A. Johnson, Jr.**, Pine Mountain, GA (US)

(**) Term: **15 Years**

(21) Appl. No.: **29/857,458**

(22) Filed: **Oct. 21, 2022**

(51) **LOC (14) Cl.** **22-05**

(52) **U.S. Cl.**
USPC **D22/134**

(58) **Field of Classification Search**
USPC D22/134, 126, 131, 133, 142, 149;
224/270, 575, 907, 922; 43/21.2
(Continued)

(56) **References Cited**

U.S. PATENT DOCUMENTS

2,139,188 A 12/1938 Haislip
2,719,659 A 10/1955 Bowman
(Continued)

FOREIGN PATENT DOCUMENTS

WO 2005084144 A2 9/2005

OTHER PUBLICATIONS

https://www.amazon.com/White-Water-Fishing-Gimbal-Stainless/dp/B06XV2PCXP/ref=sr_1_7?crid=2HRAIIDYD6YY&keywords=fishing%2Brod%2Bgimbal&qid=1668538197&srefix=fishing%2Bgimb%2Caps%2C137&sr=8-7&th=1 (Year: 2017).*

(Continued)

Primary Examiner — Catherine R Oliver-Garcia
(74) *Attorney, Agent, or Firm* — Marks Gray, P.A.;
Mitchell Ghaneie; Christopher Roberts

(57) **CLAIM**

The ornamental design for a fishing gimbal, as shown and described.

DESCRIPTION

FIG. 1 is a front perspective view of a first embodiment of a fishing gimbal;
FIG. 2 is a rear perspective view thereof;
FIG. 3 is a top view thereof;
FIG. 4 is a bottom view thereof;
FIG. 5 is a left side view thereof;
FIG. 6 is a right side view thereof;
FIG. 7 is a front view thereof;
FIG. 8 is a rear view thereof;
FIG. 9 is a front perspective view of a second embodiment of the fishing gimbal;
FIG. 10 is a rear perspective view of the second embodiment of the fishing gimbal;
FIG. 11 is a top view of the second embodiment of the fishing gimbal;
FIG. 12 is a bottom view of the second embodiment of the fishing gimbal;
FIG. 13 is a left side view of the second embodiment of the fishing gimbal;
FIG. 14 is a right side view of the second embodiment of the fishing gimbal;
FIG. 15 is a front view of the second embodiment of the fishing gimbal;
FIG. 16 is a rear view of the second embodiment of the fishing gimbal;
FIG. 17 a front perspective view of a third embodiment of the fishing gimbal;
FIG. 18 is a rear perspective view of the third embodiment of the fishing gimbal;
FIG. 19 is a top view of the third embodiment of the fishing gimbal;
FIG. 20 is a bottom view of the third embodiment of the fishing gimbal;
FIG. 21 is a left side view of the third embodiment of the fishing gimbal;
FIG. 22 is a right side view of the third embodiment of the fishing gimbal;

(Continued)

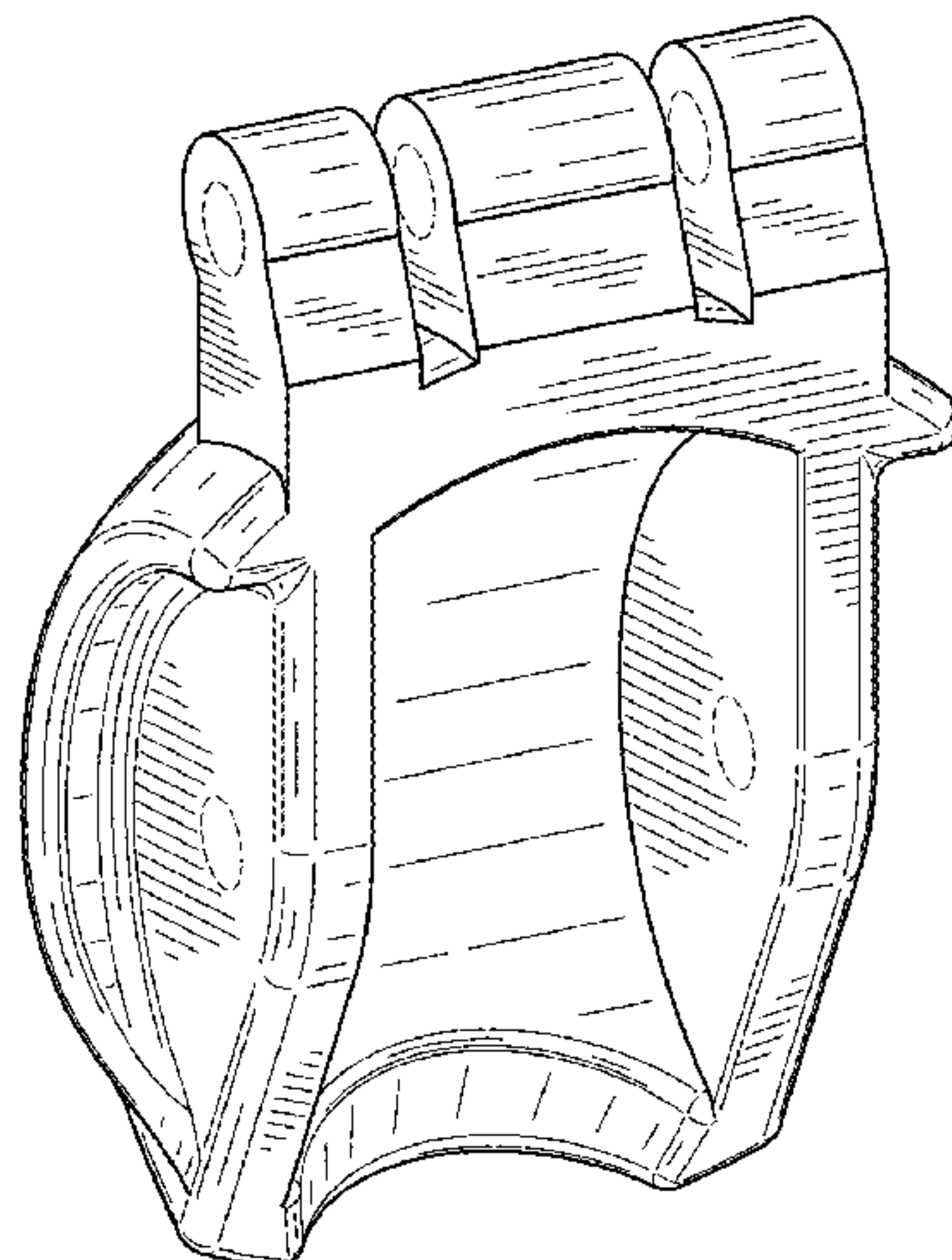

FIG. 23 is a front view of the third embodiment of the fishing gimbal; and,

FIG. 24 is a rear view of the third embodiment of the fishing gimbal.

The broken lines depict portions of the fishing gimbal that form no part of the claimed design.

1 Claim, 12 Drawing Sheets

(58) **Field of Classification Search**

CPC A01K 85/18; A01K 87/02; A01K 87/008;
A01K 87/009; A01K 97/10

See application file for complete search history.

(56) **References Cited**

U.S. PATENT DOCUMENTS

3,115,997 A 12/1963 Hengst
4,081,115 A 3/1978 White et al.
5,024,018 A 6/1991 Ferrigno

5,105,574 A 4/1992 Fast
5,564,217 A 10/1996 Riedell
6,185,856 B1 2/2001 Yakabe
D470,214 S * 2/2003 Wickizer 43/21.2
6,561,471 B1 * 5/2003 Hawie A01K 97/10
248/74.1
D584,792 S * 1/2009 Childers D22/147
10,362,775 B1 * 7/2019 Begin A01K 97/10
43/21.2
10,542,739 B1 1/2020 Silverman
D956,172 S * 6/2022 Vigil D22/142
2004/0049967 A1 3/2004 DeSorcy
2014/0183240 A1 7/2014 Silverman

OTHER PUBLICATIONS

https://www.amazon.com/TIHOOD-Fighting-Adjustable-Professional-Fishermen/dp/B07RRBGTX8/ref=sr_1_1?crid=1WJ408EW2JL14&keywords=tihood+fighting+rod+pole+holder+adjustable+waist+gimbal+belt&qid=1668707963&srefix=tihood+fight%2Caps%2C79&sr=8-1 (Year: 2019).*

* cited by examiner

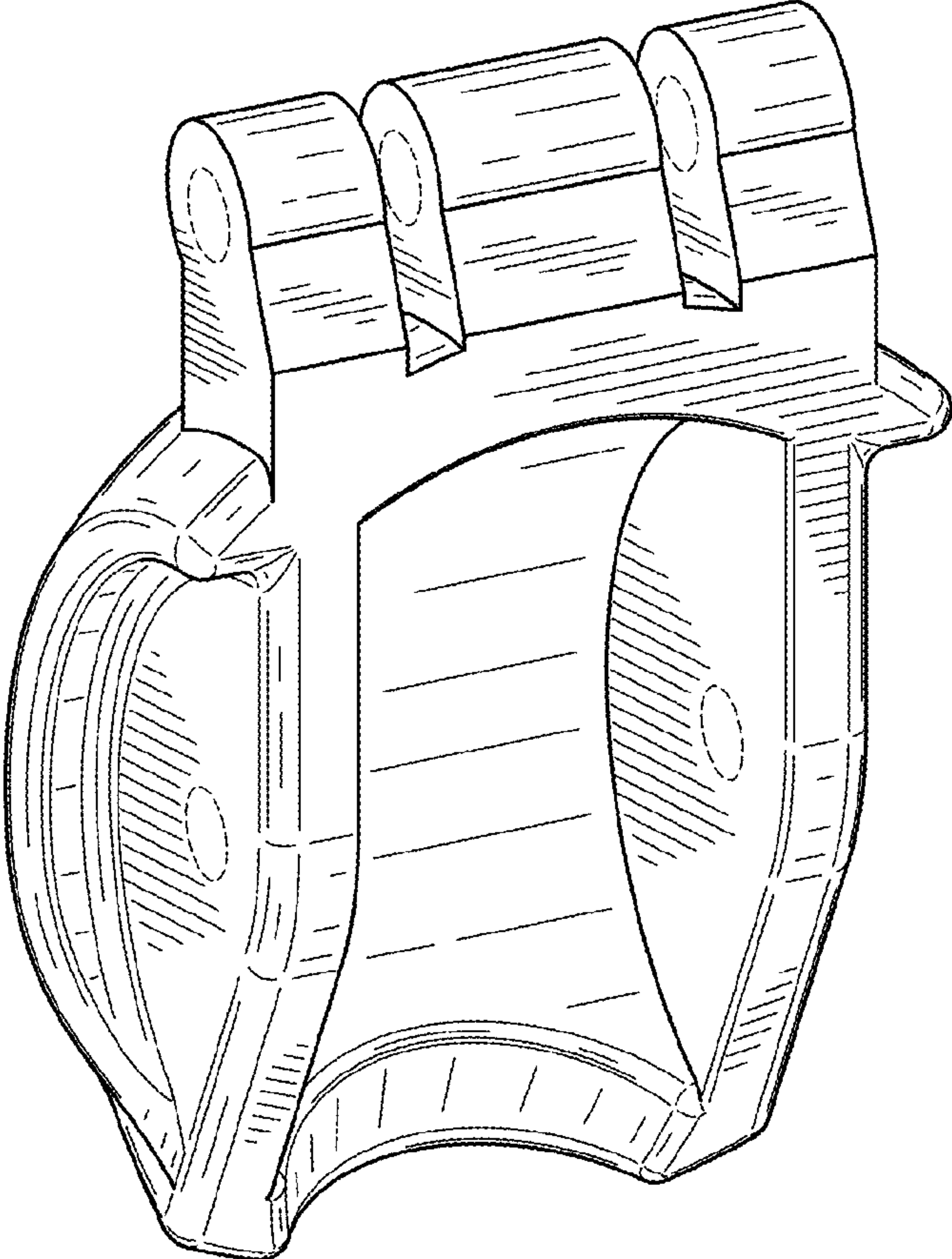

FIG. 1

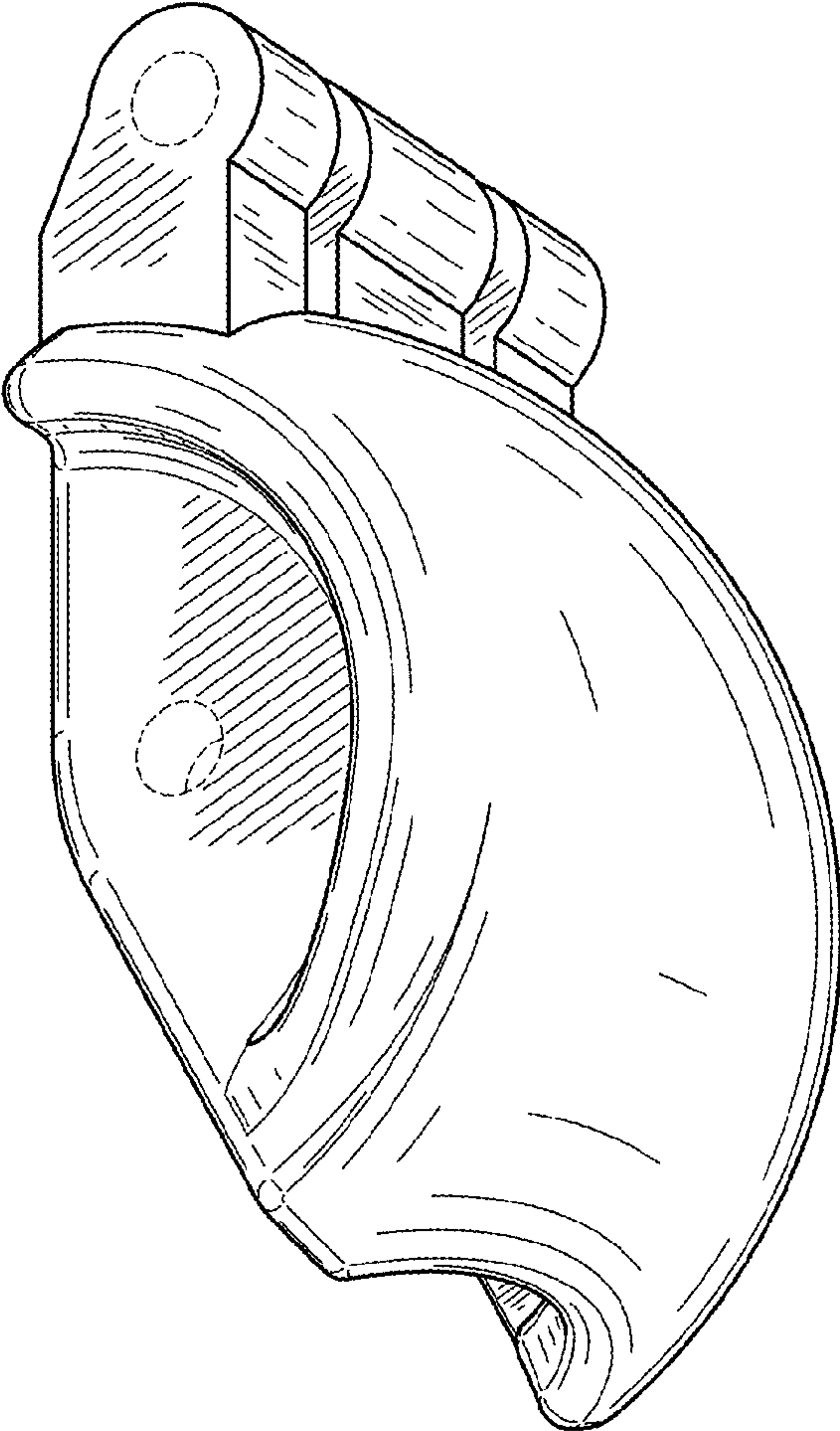

FIG. 2

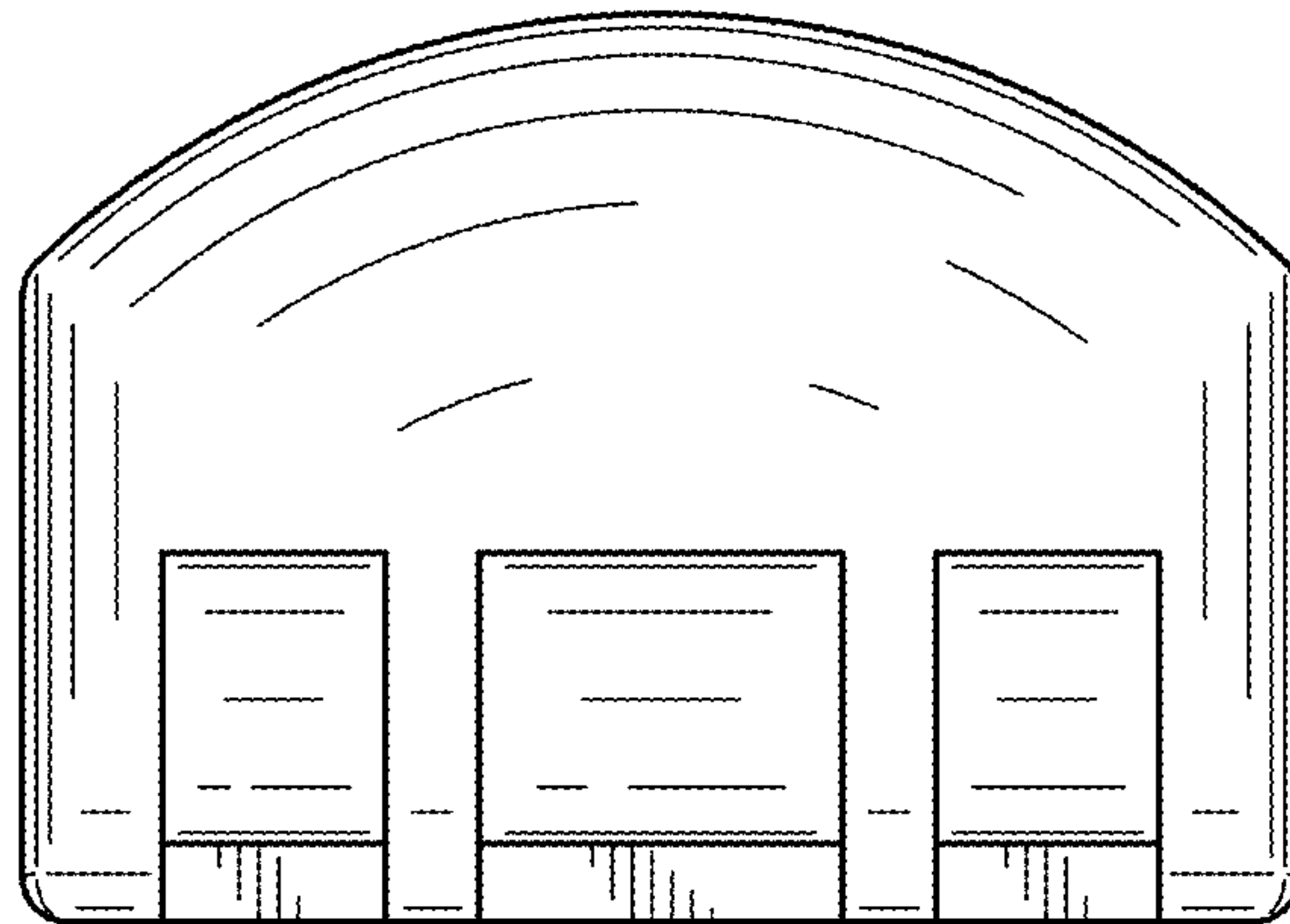

FIG. 3

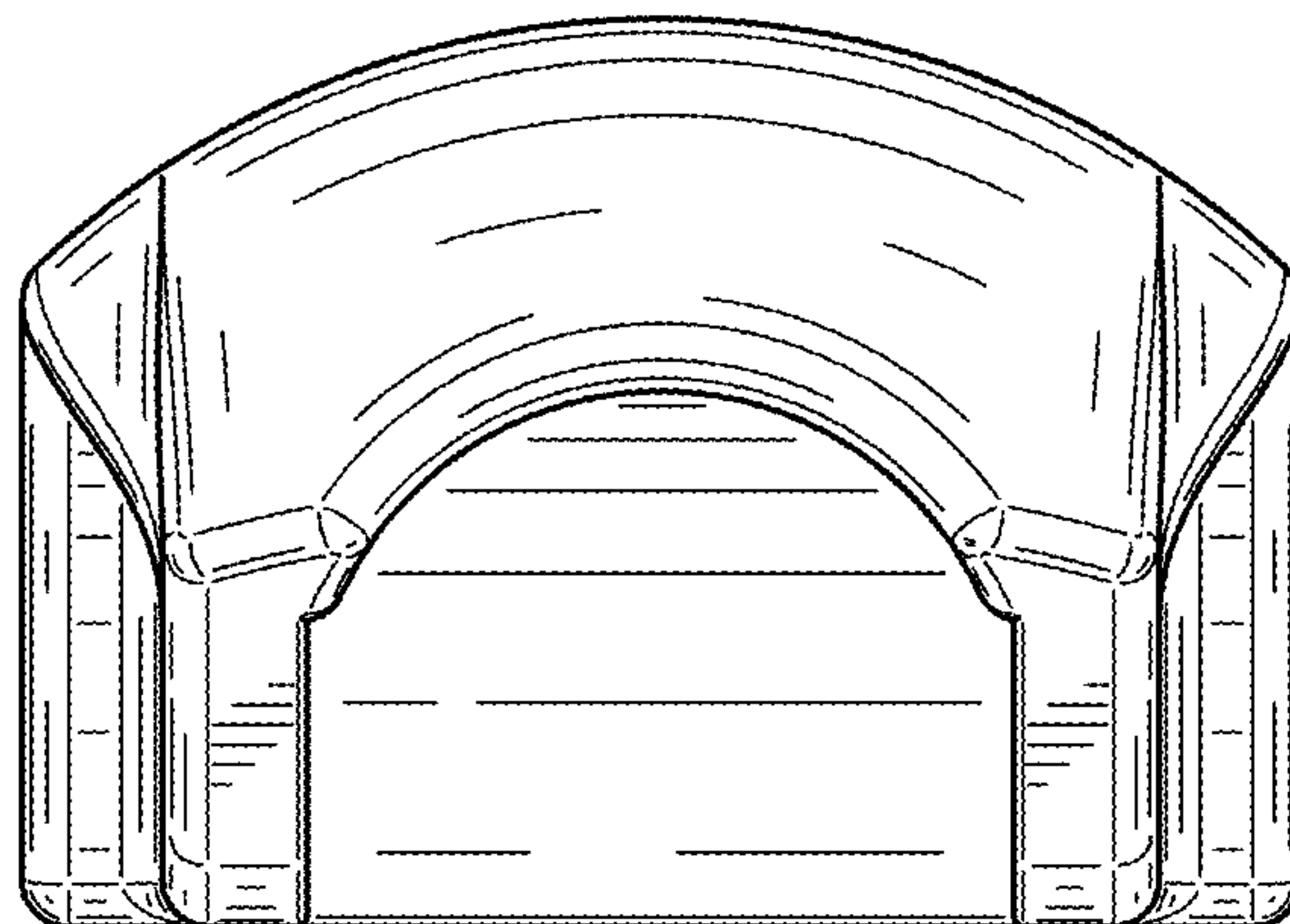

FIG. 4

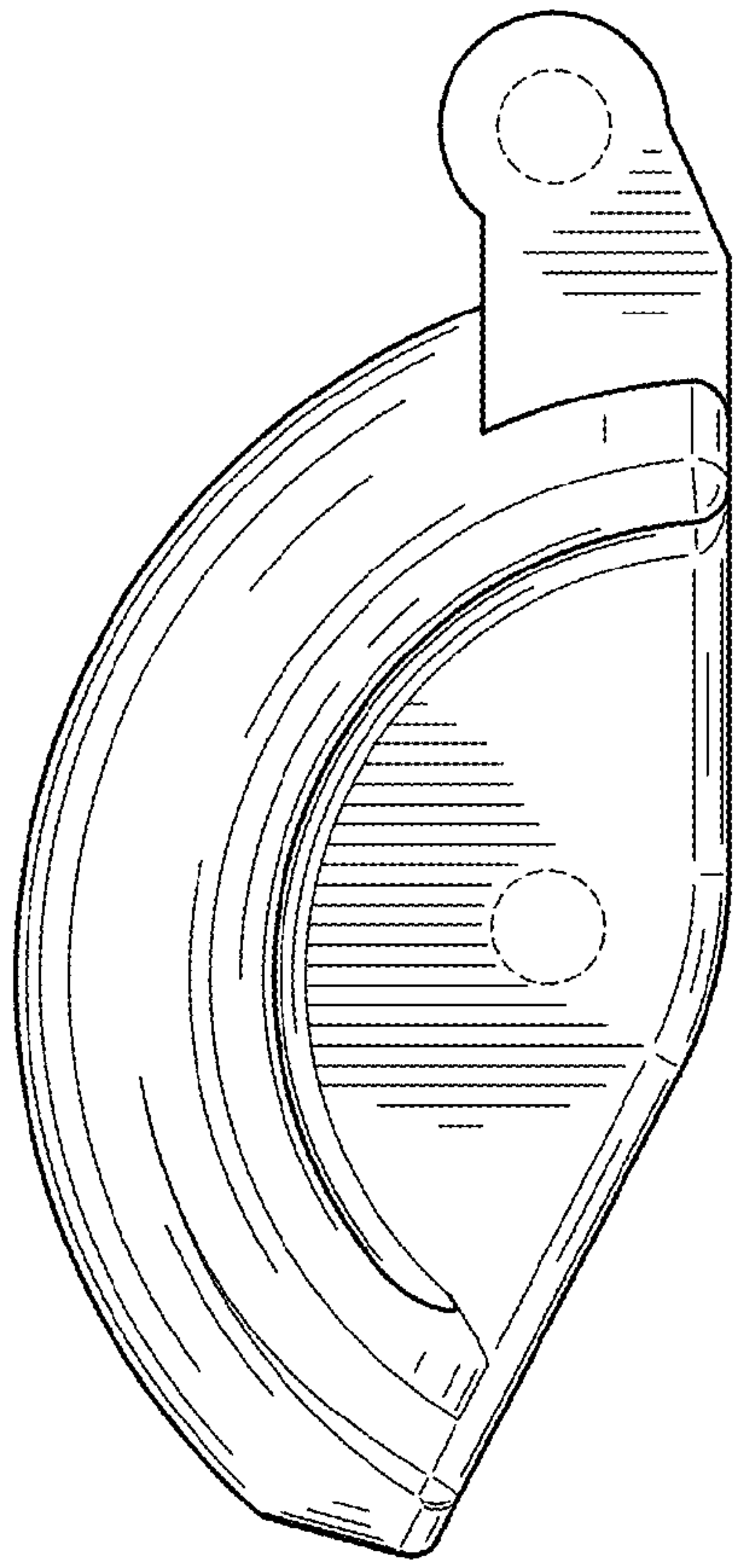

FIG. 5

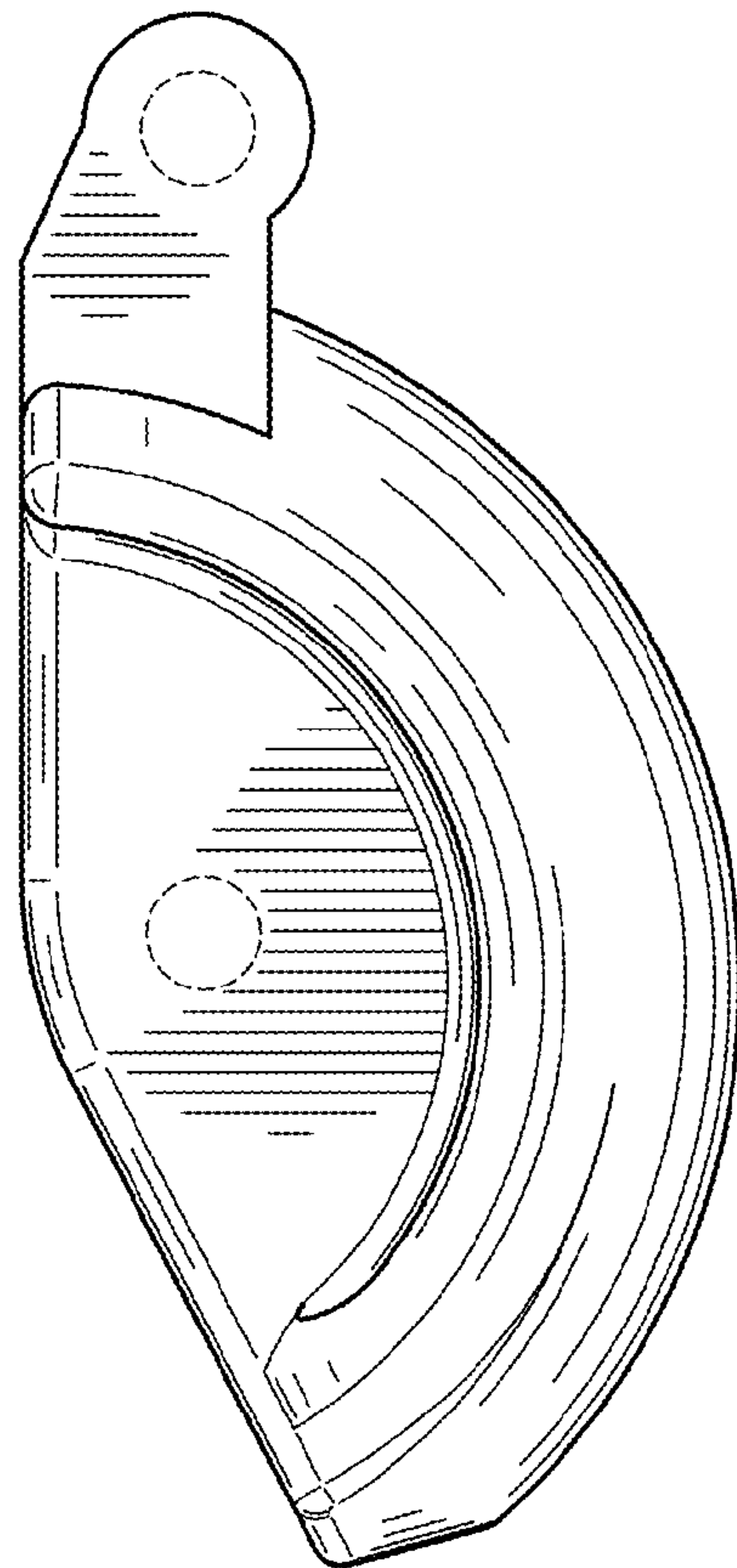

FIG. 6

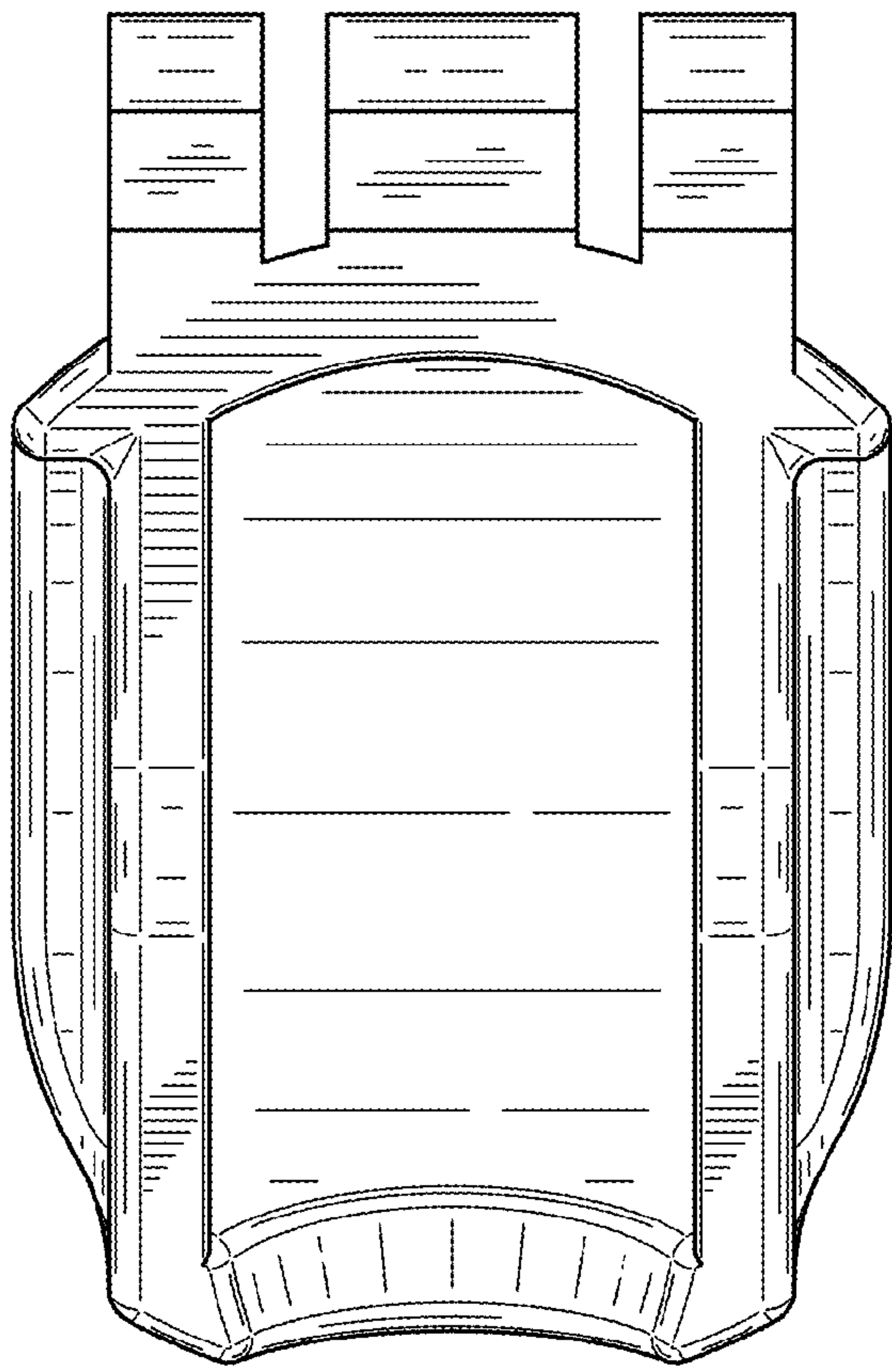

FIG. 7

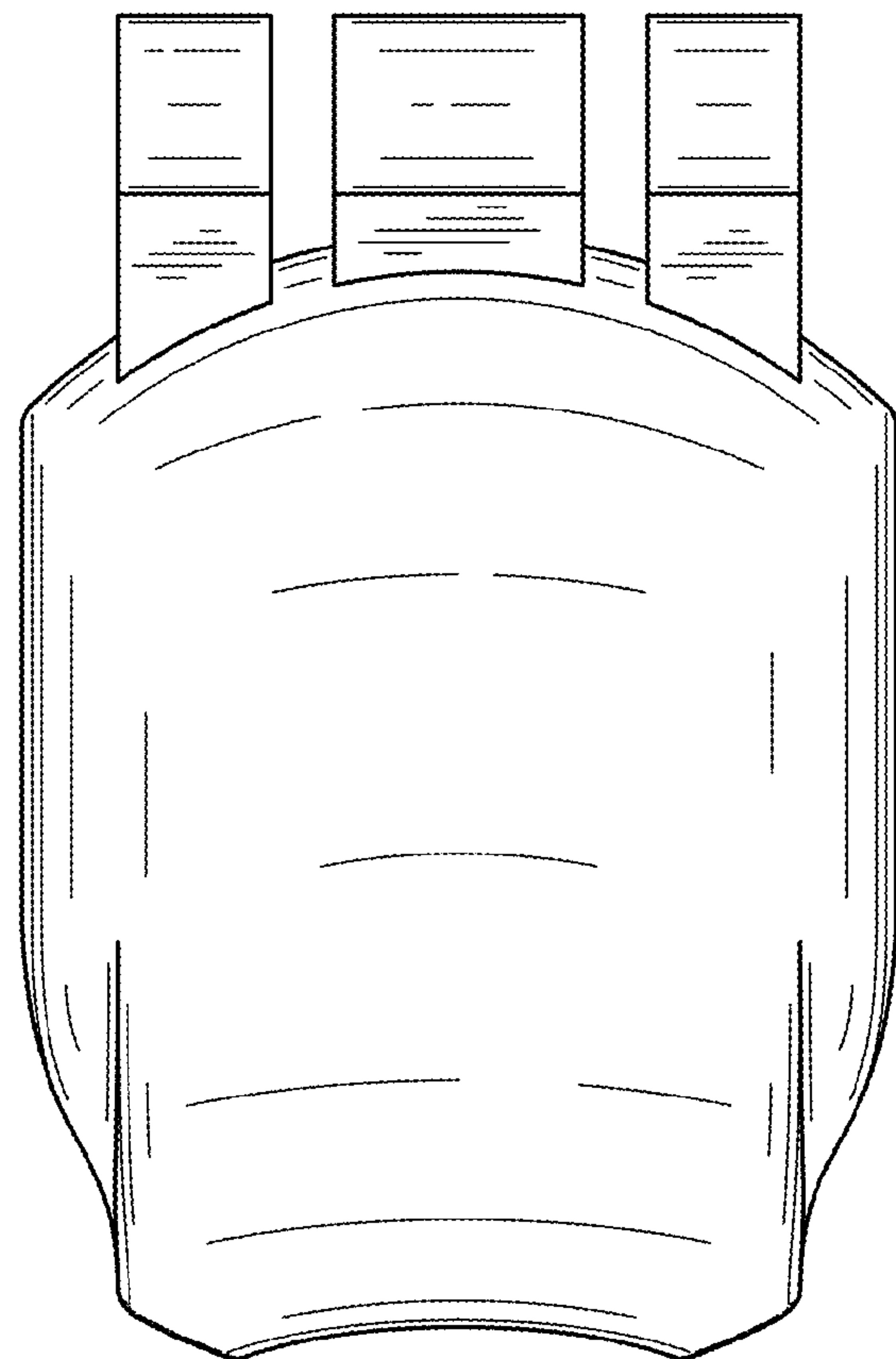

FIG. 8

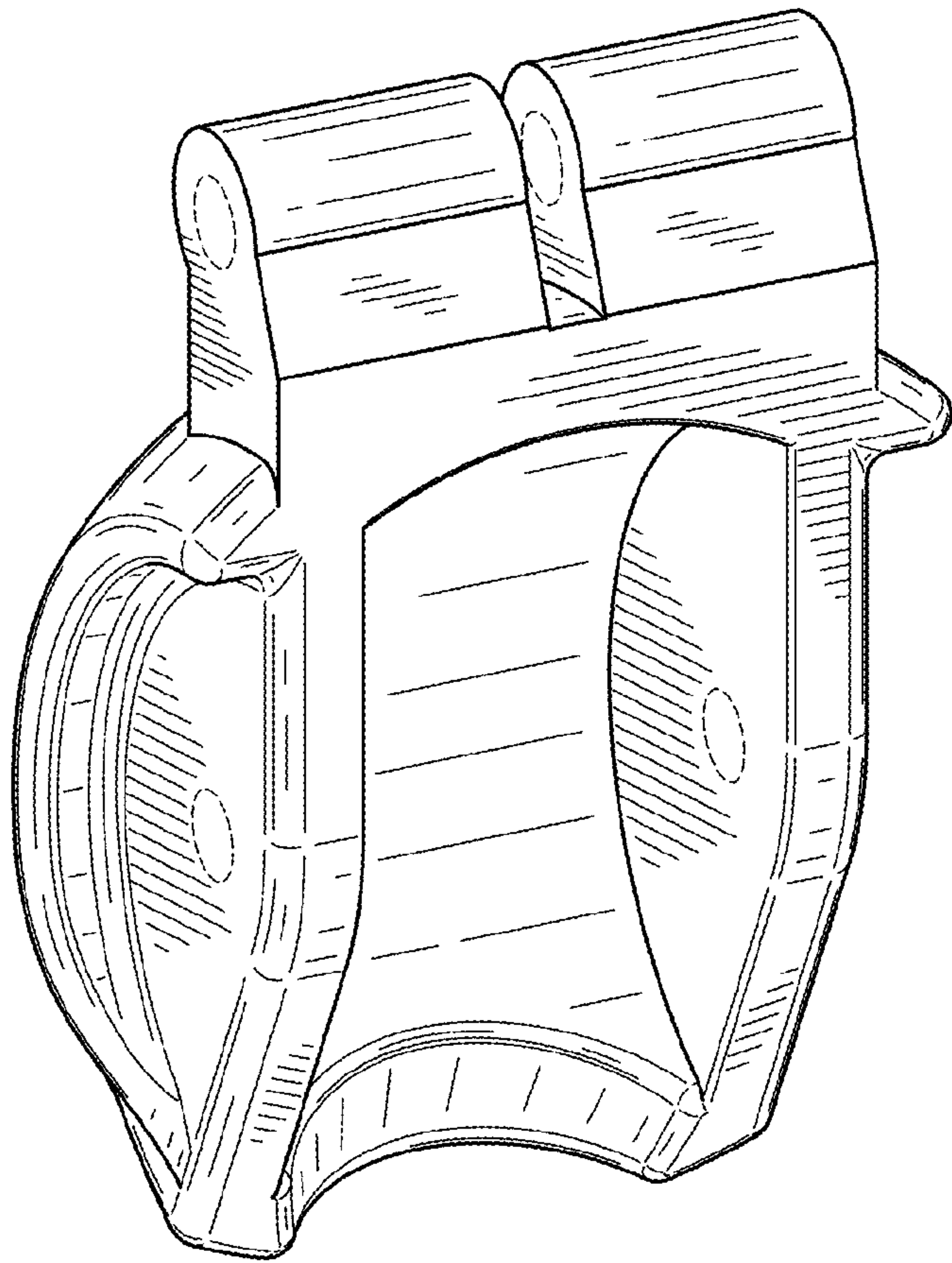

FIG. 9

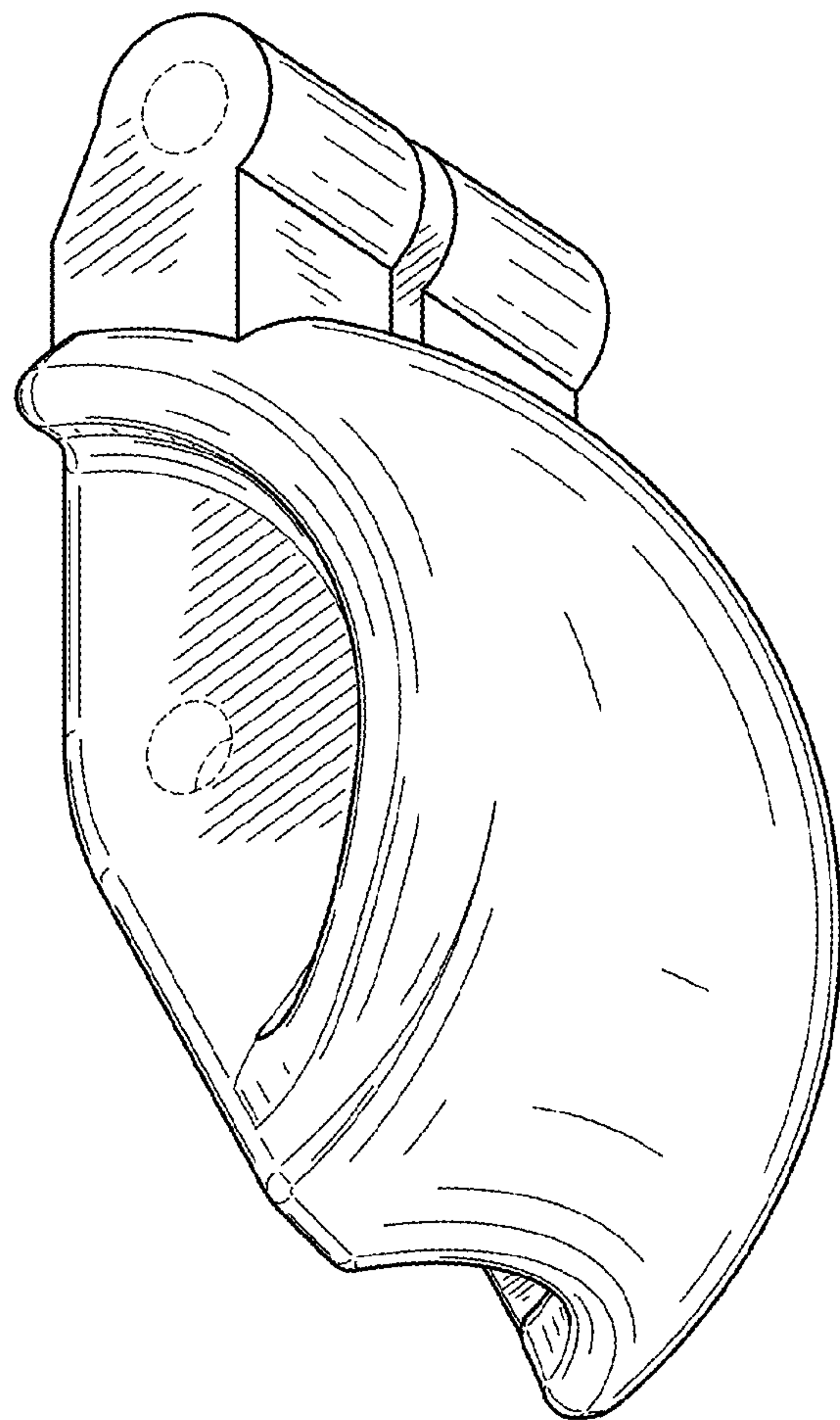

FIG. 10

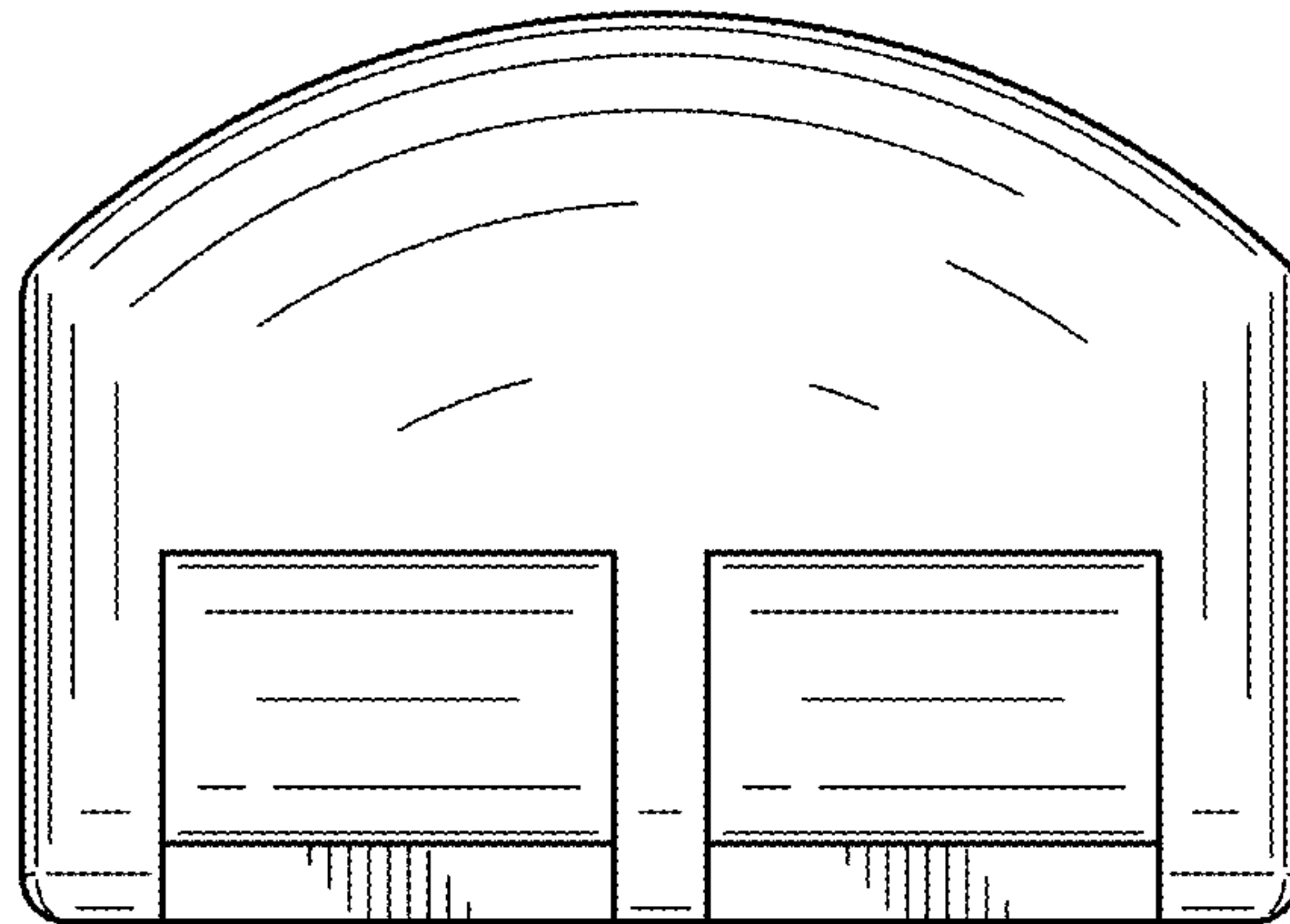

FIG. 11

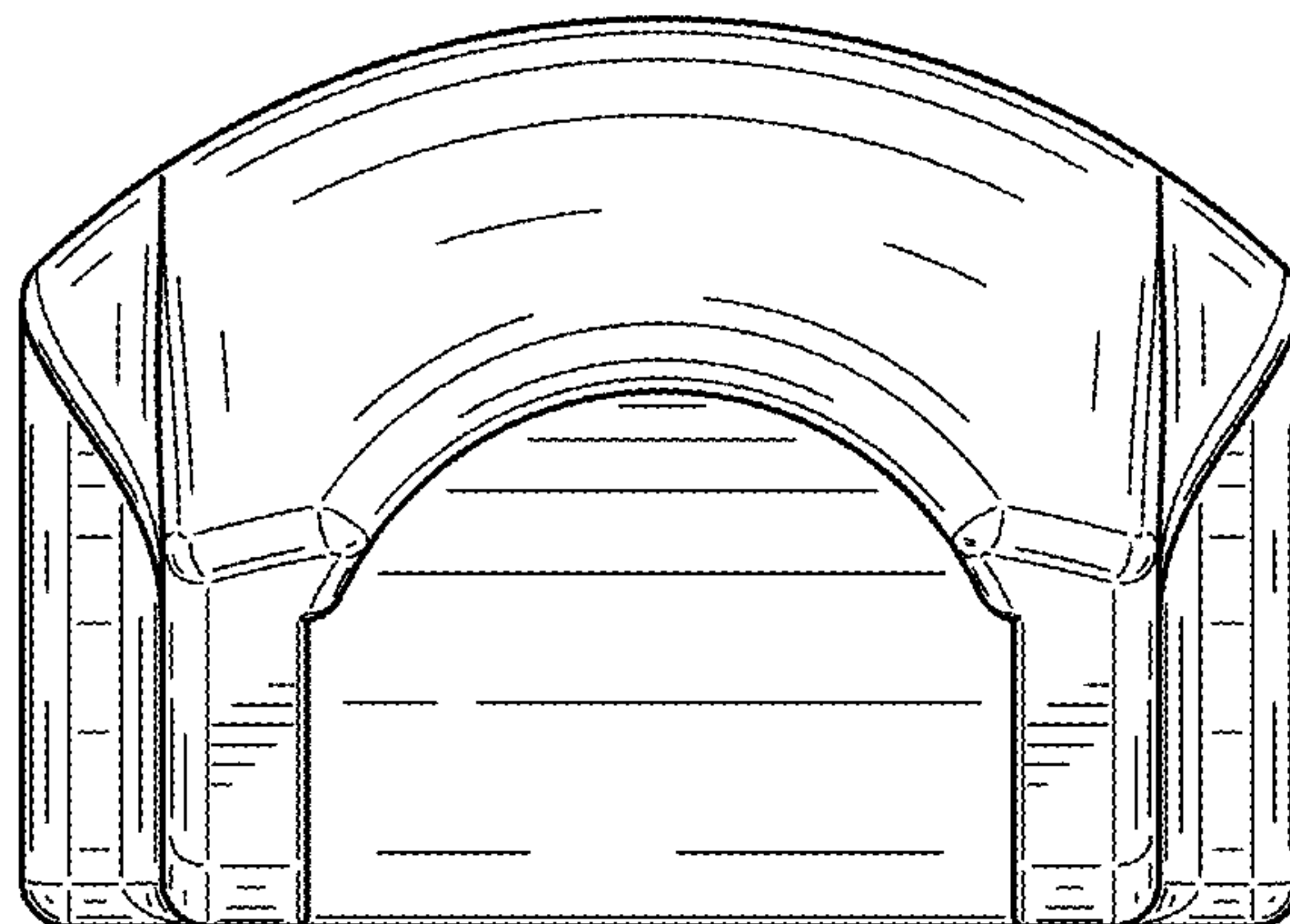

FIG. 12

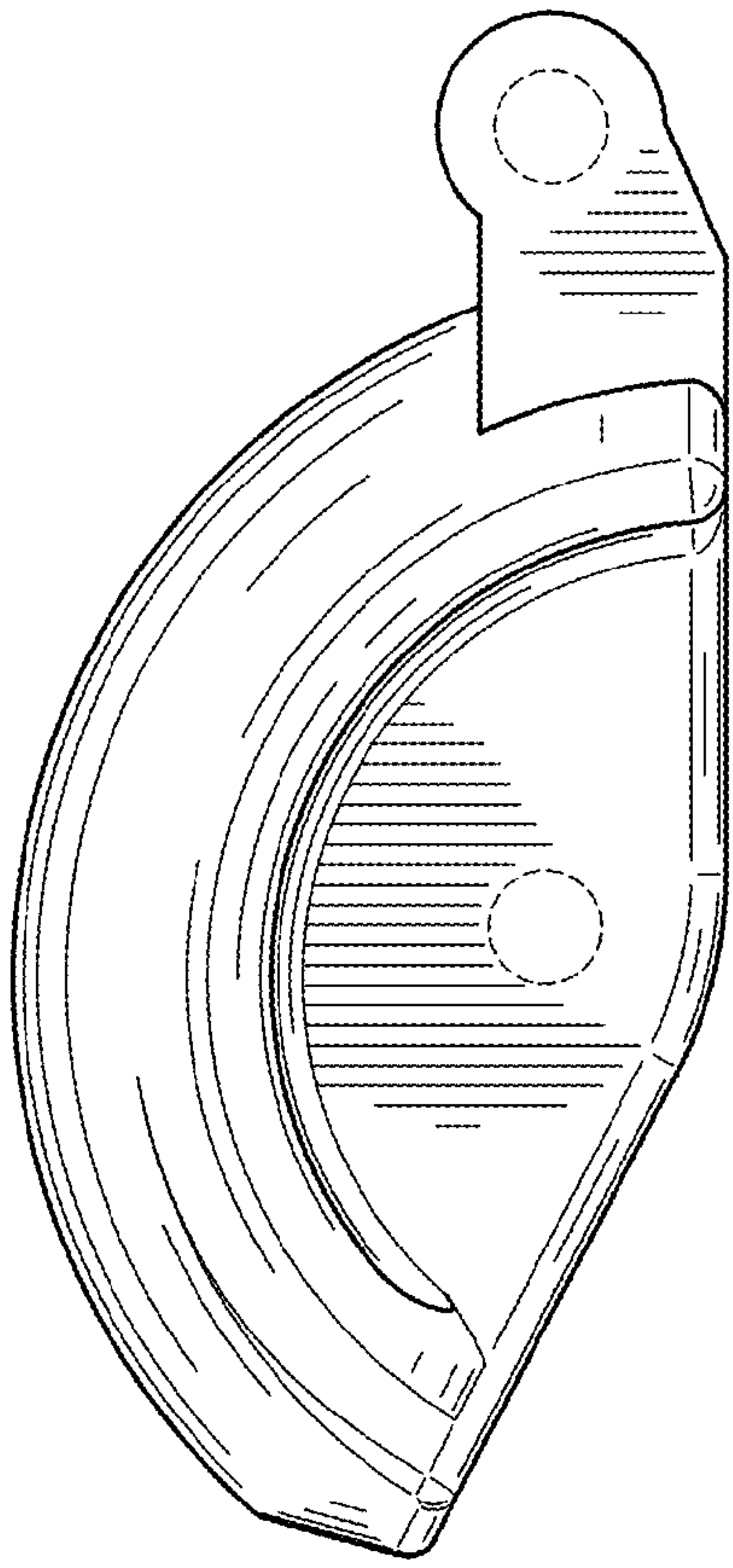

FIG. 13

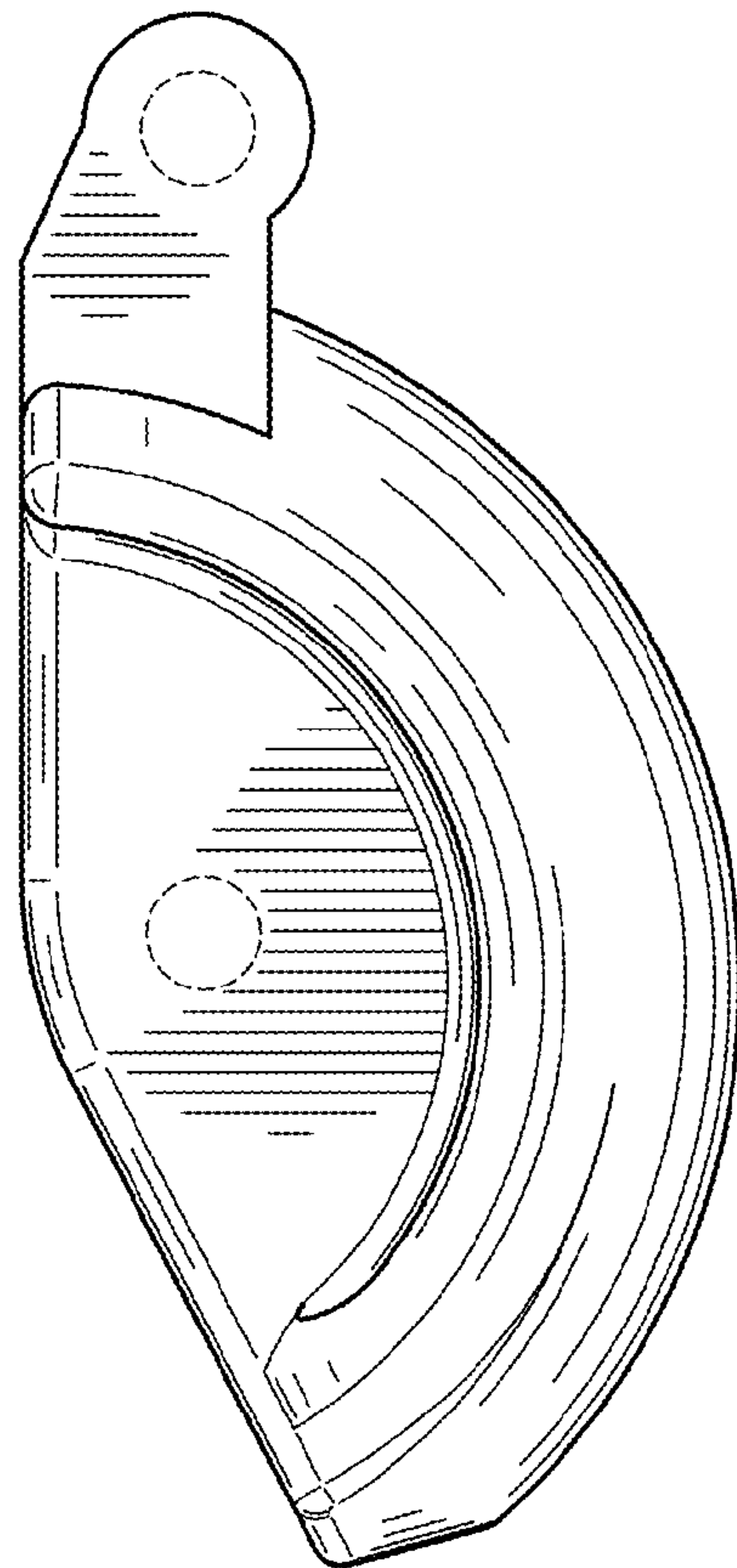

FIG. 14

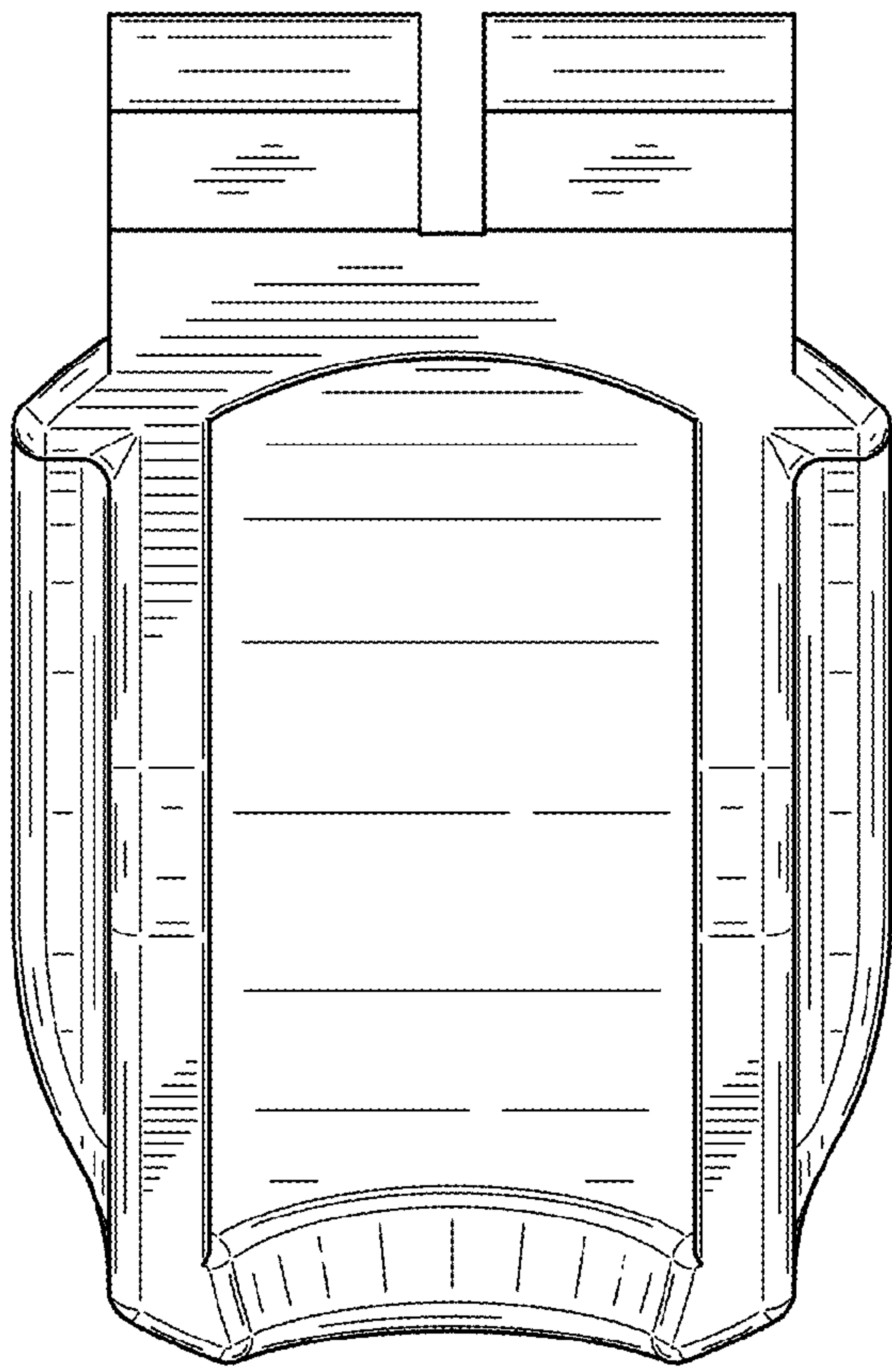

FIG. 15

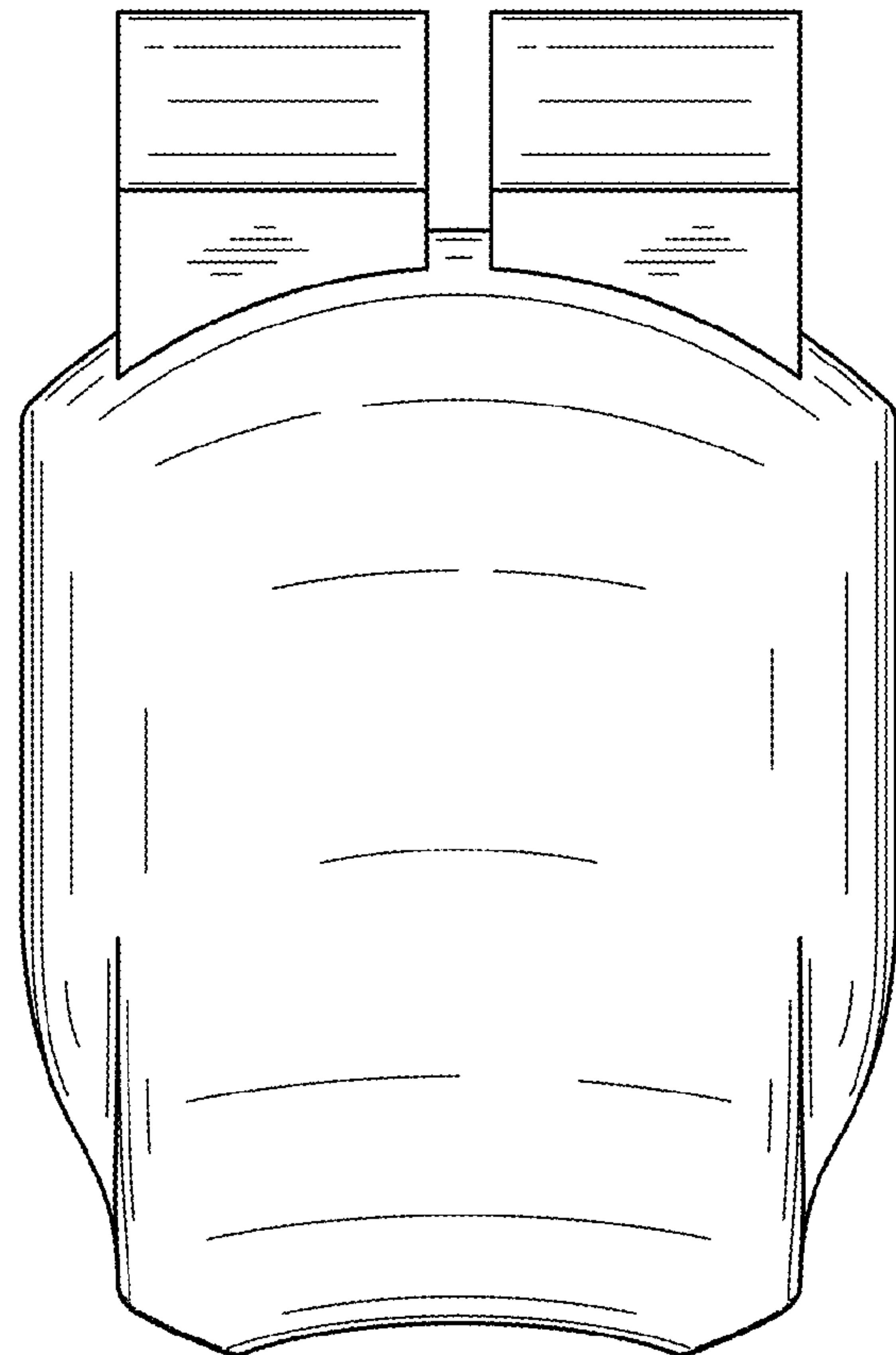

FIG. 16

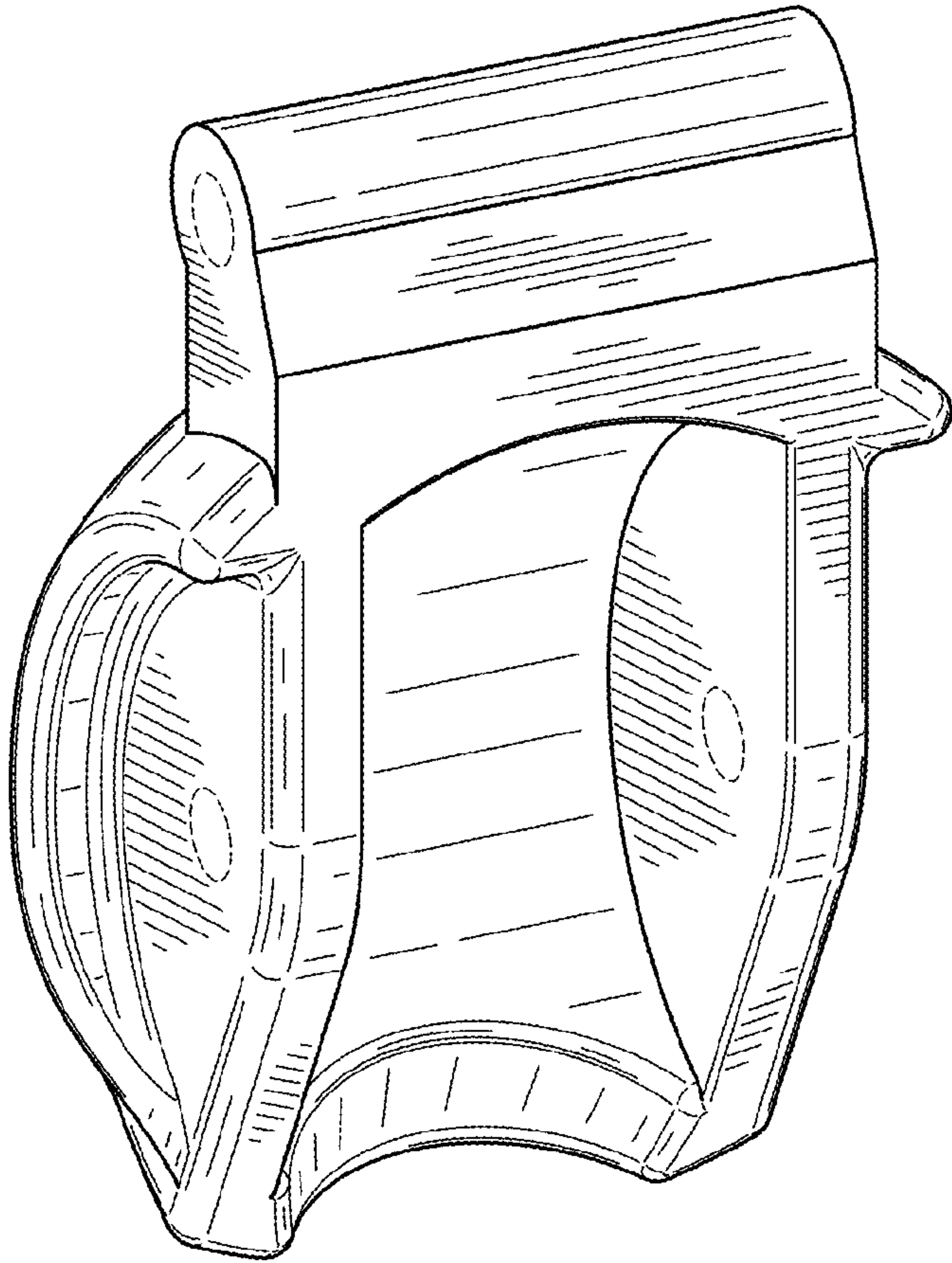

FIG. 17

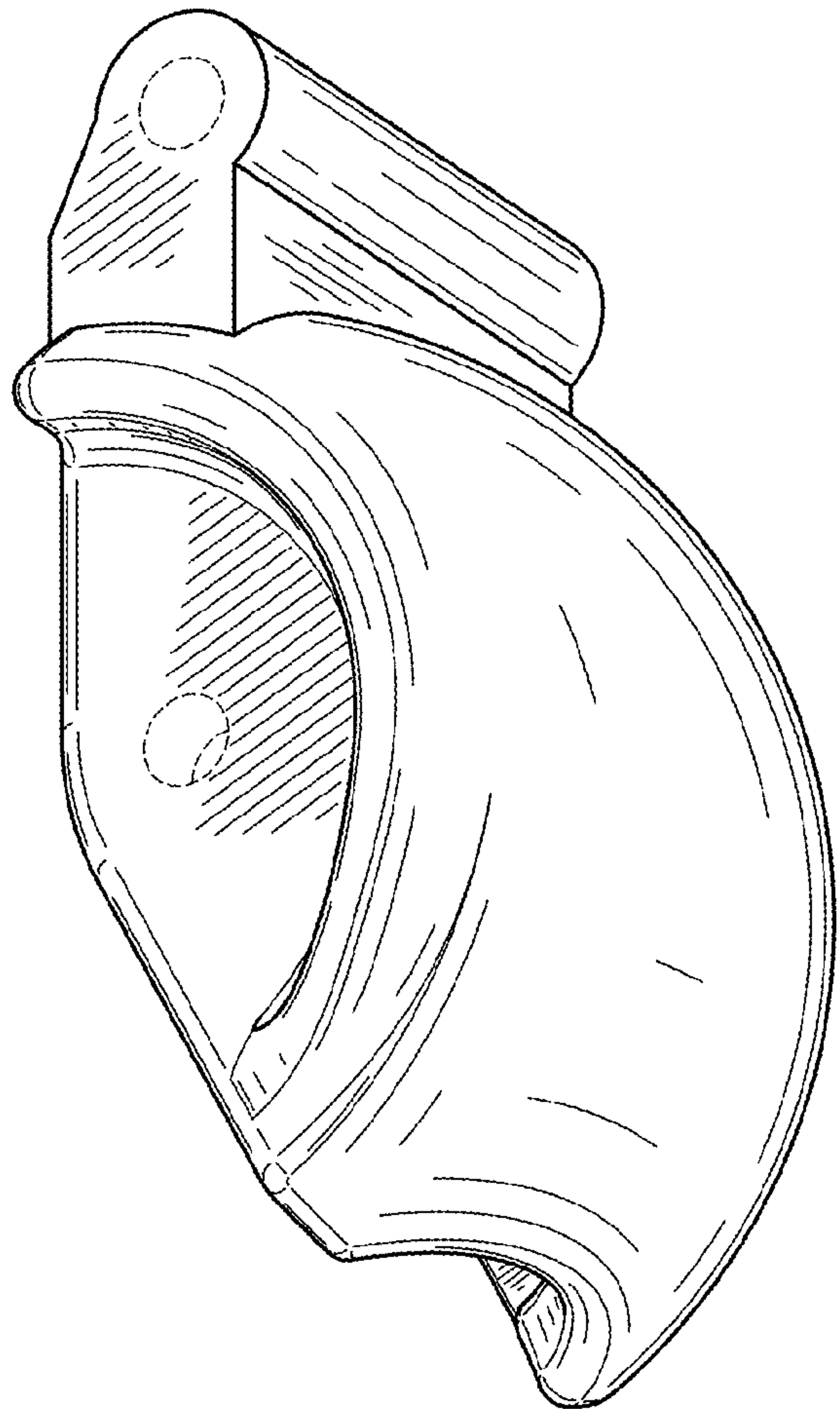

FIG. 18

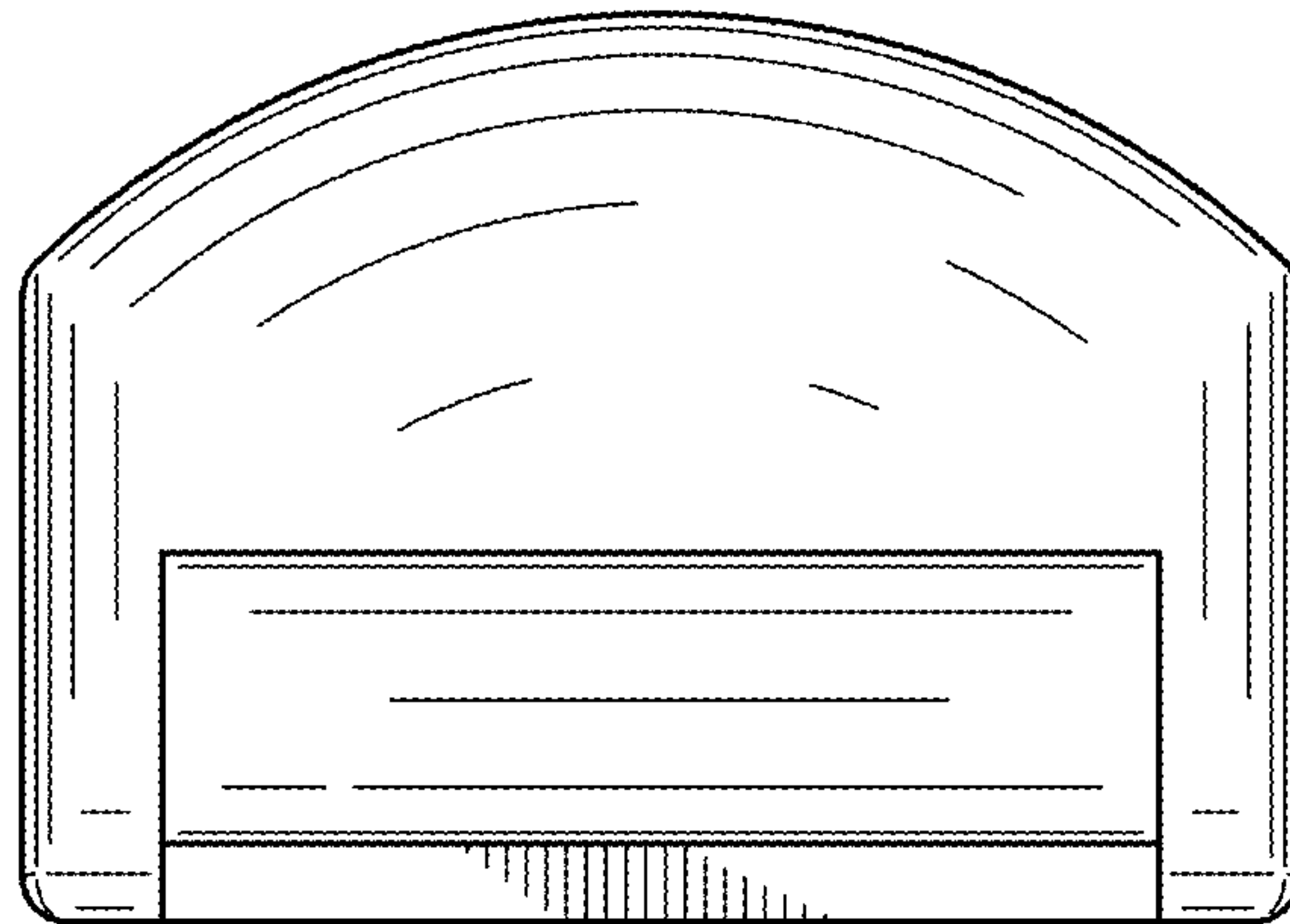

FIG. 19

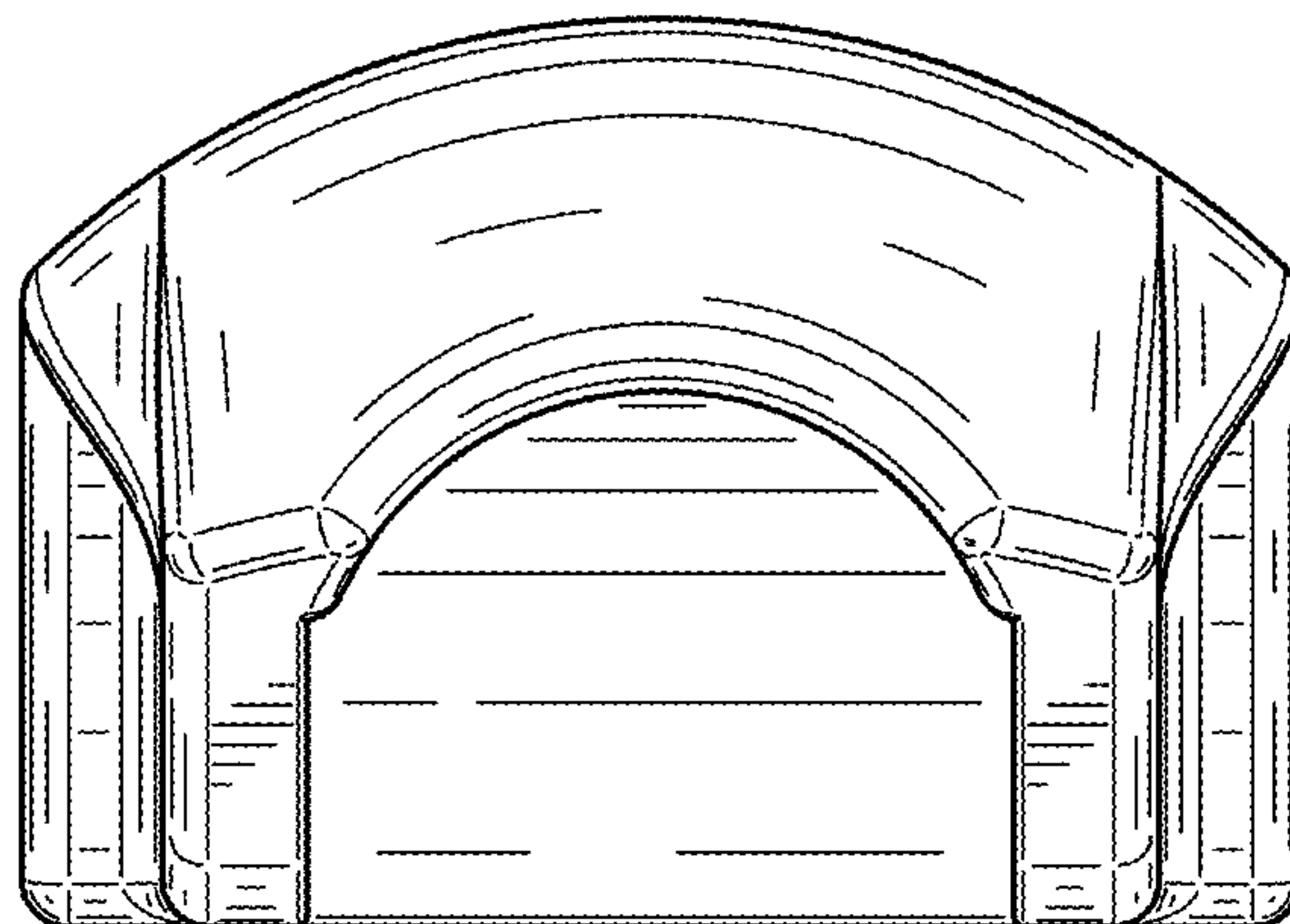

FIG. 20

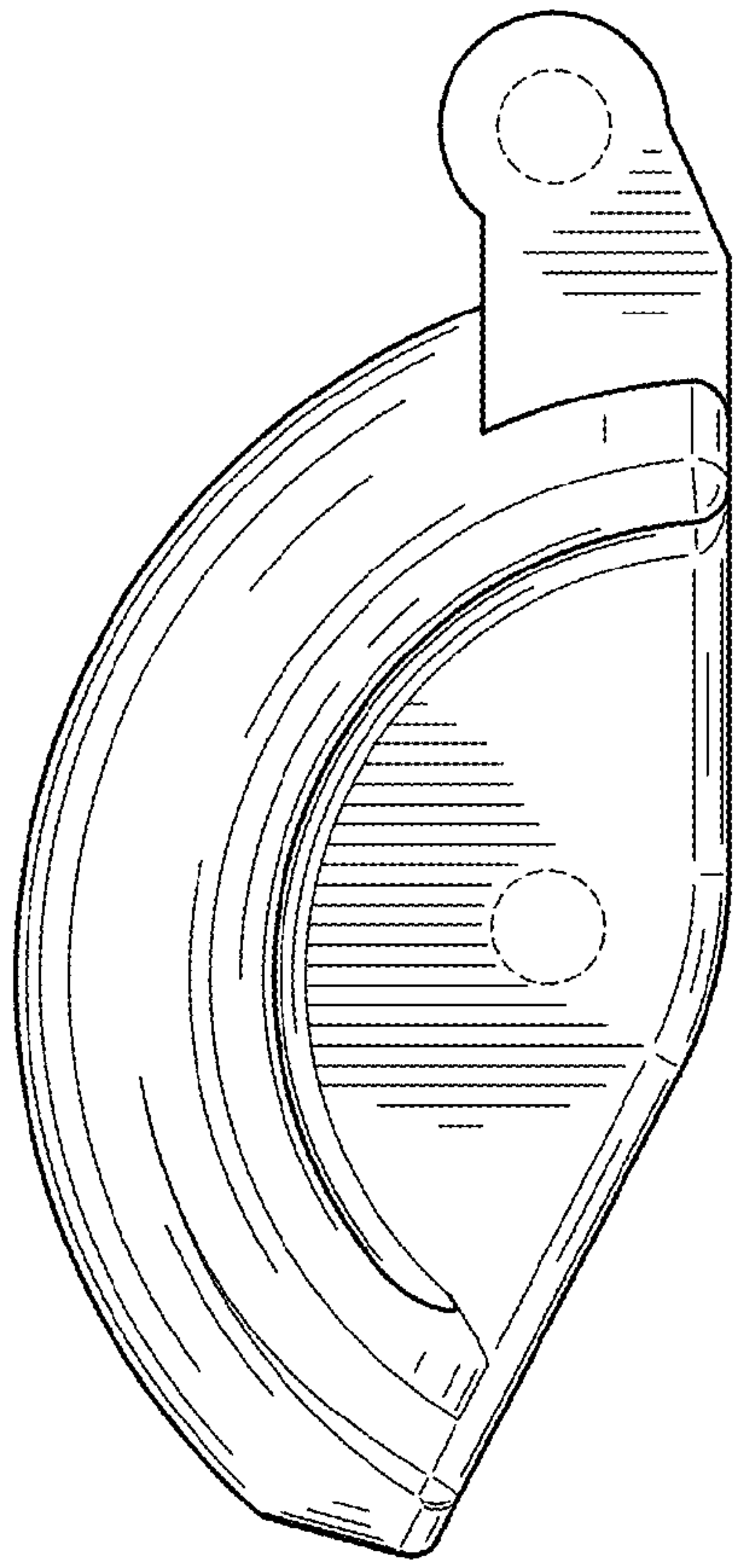

FIG. 21

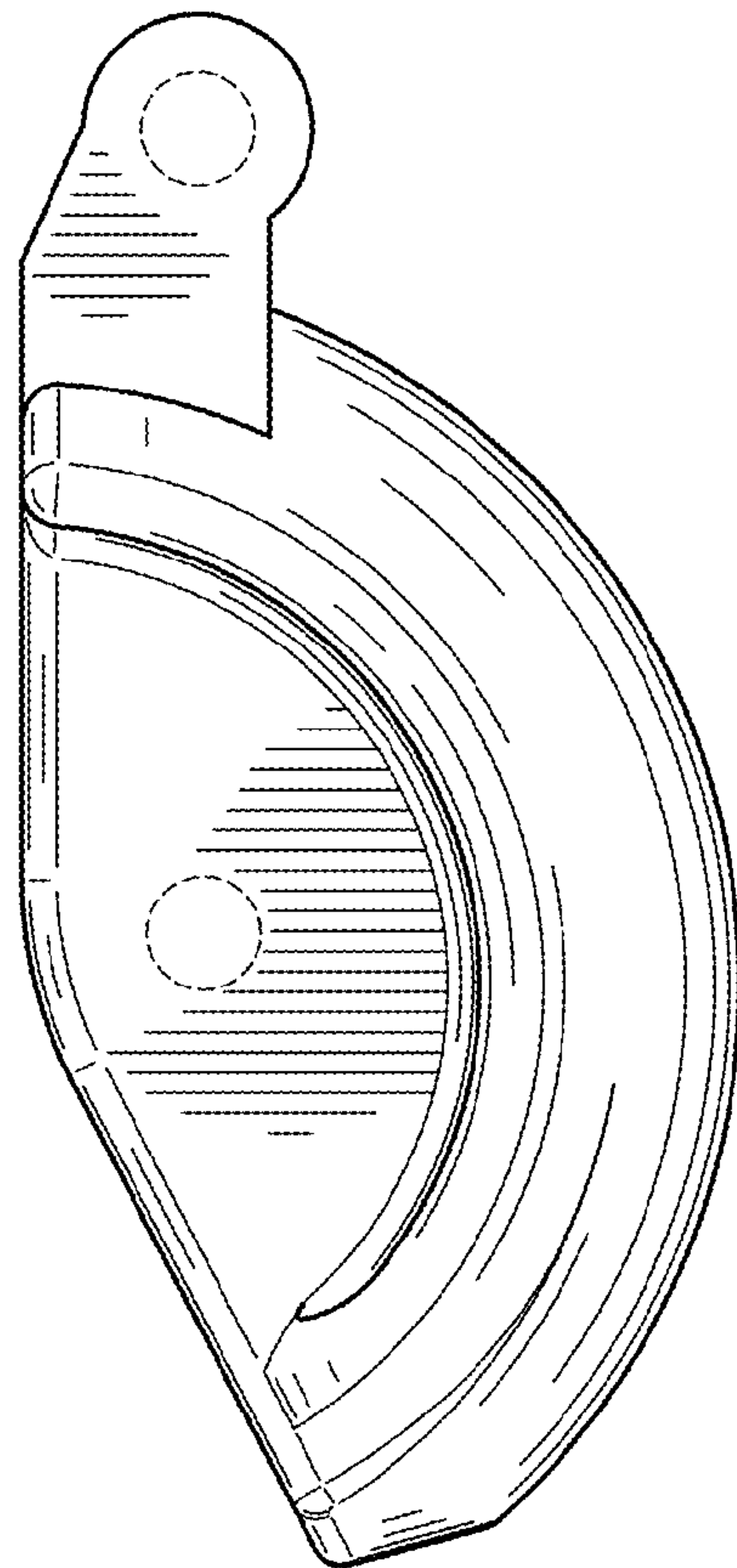

FIG. 22

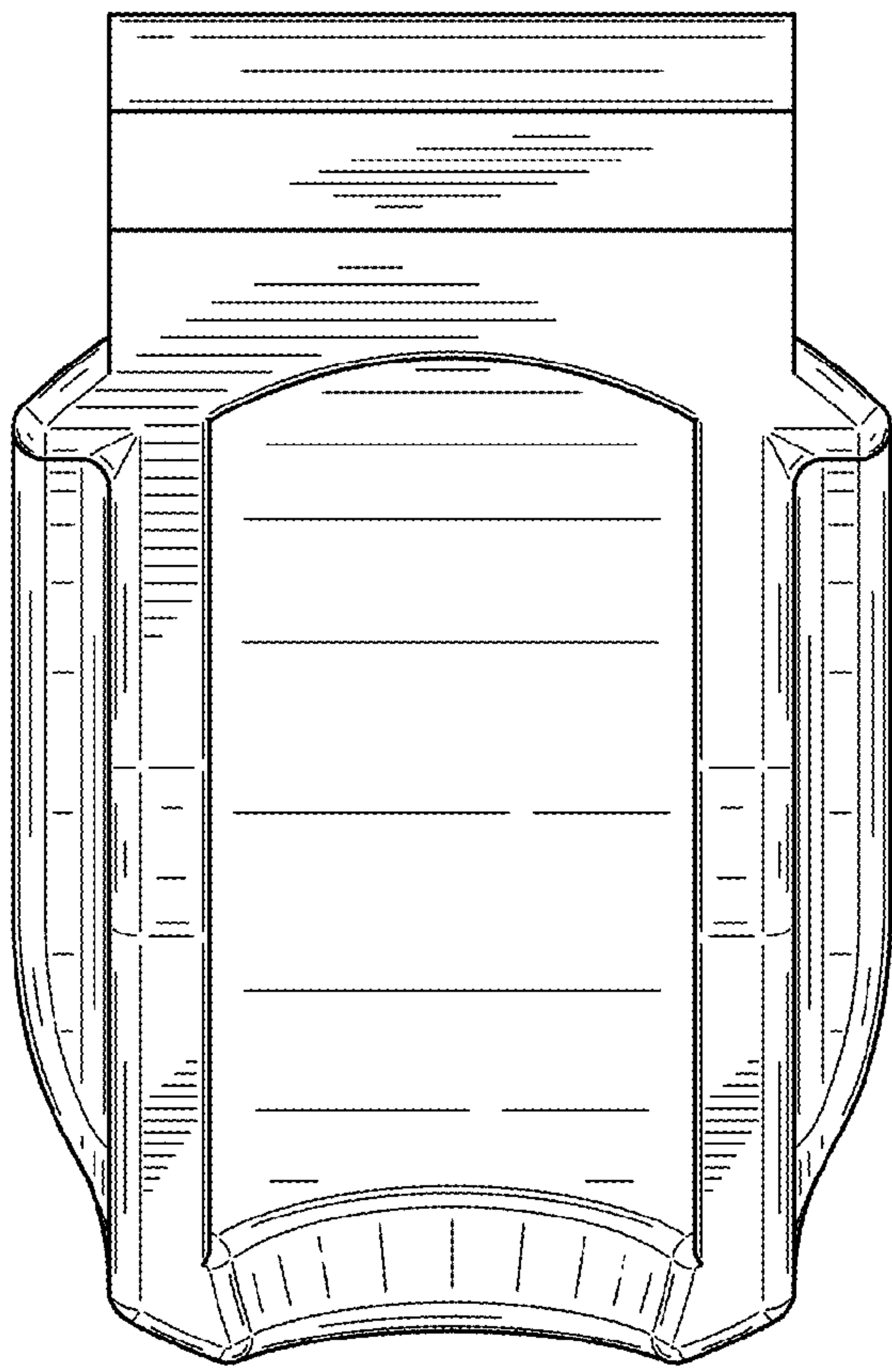

FIG. 23

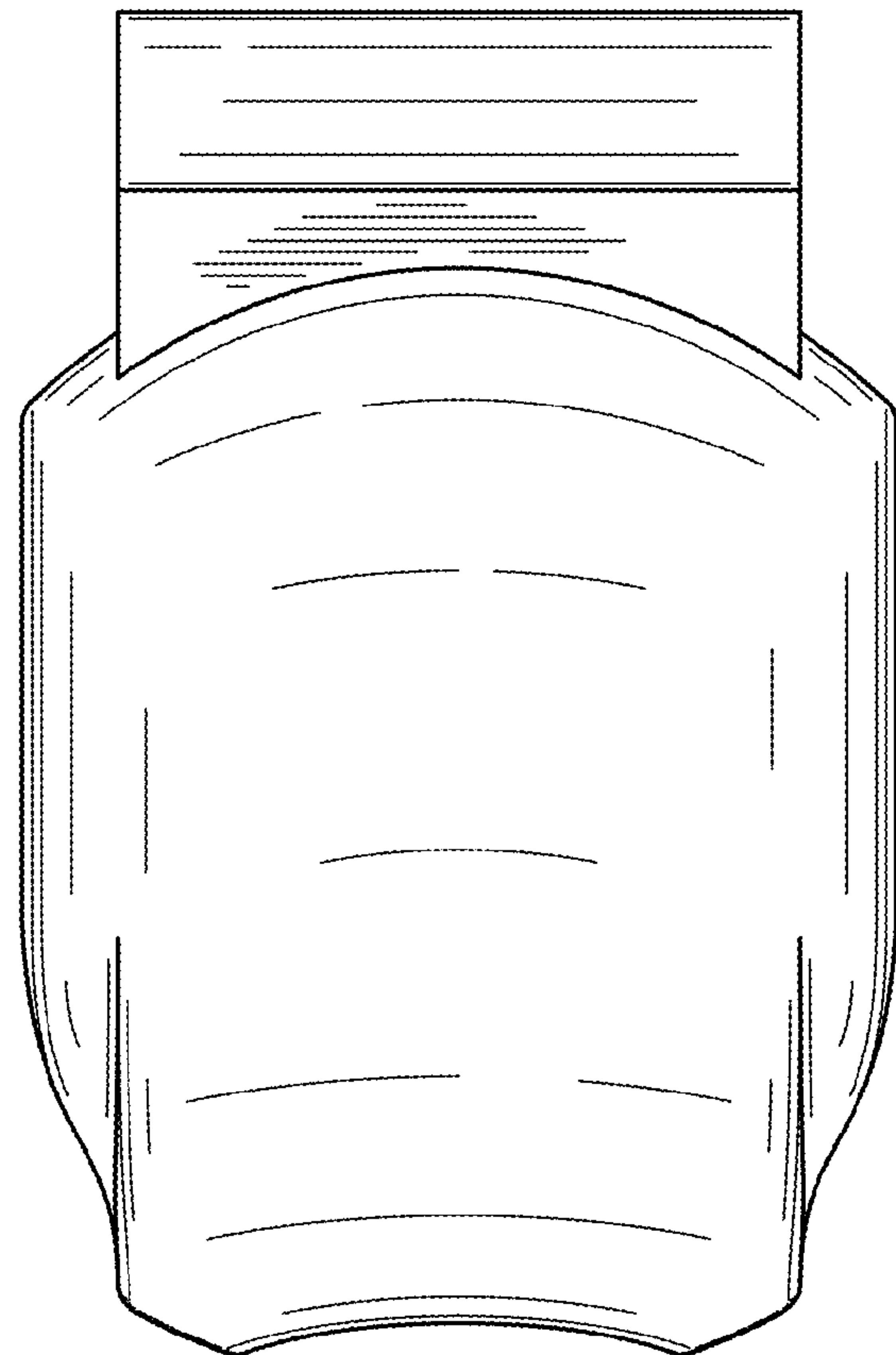

FIG. 24