



US00D979000S

(12) **United States Design Patent**
Thomas et al.

(10) **Patent No.:** **US D979,000 S**
(45) **Date of Patent:** **** Feb. 21, 2023**

(54) **CLIMBING WALL**

(71) Applicant: **Eldorado Wall Company, Inc.**,
Louisville, CO (US)

(72) Inventors: **Jason Thomas**, Arvada, CO (US);
Mark Hemphill, Erie, CO (US)

(73) Assignee: **Eldorado Wall Company, Inc.**,
Louisville, CO (US)

(**) Term: **15 Years**

(21) Appl. No.: **29/785,393**

(22) Filed: **May 25, 2021**

(51) **LOC (14) Cl.** **21-03**

(52) **U.S. Cl.**
USPC **D21/826**

(58) **Field of Classification Search**

USPC D21/814, 826, 519, 530, 398, 412, 421,
D21/474, 475, 494, 501, 502, 504, 505,
D21/511; D25/6, 19, 21, 22, 23, 32, 66
See application file for complete search history.

(56) **References Cited**

U.S. PATENT DOCUMENTS

1,997,022 A * 4/1935 Stalker A63F 9/088
D11/89
D285,706 S * 9/1986 Knudsen D21/505
(Continued)

Primary Examiner — Khawaja Anwar

Assistant Examiner — Julice Seung Eun Oum

(74) *Attorney, Agent, or Firm* — Merchant & Gould P.C.

(57) **CLAIM**

The ornamental design for a climbing wall, as shown and described.

DESCRIPTION

FIG. 1 is a perspective view of a first embodiment of a climbing wall shown in a condition of use according to the new design.

FIG. 2 is another perspective view of the climbing wall of FIG. 1.

FIG. 3 is a front elevation view of the climbing wall of FIG. 1.

FIG. 4 is a back elevation view of the climbing wall of FIG. 1.

FIG. 5 is a right side elevation view of the climbing wall of FIG. 1.

FIG. 6 is a left side elevation view of the climbing wall of FIG. 1.

FIG. 7 is a top plan view of the climbing wall of FIG. 1.

FIG. 8 is a bottom plan view of the climbing wall of FIG. 1.

FIG. 9 is a perspective view of a second embodiment of a climbing wall shown in the condition of use according to the new design.

FIG. 10 is another perspective view of the climbing wall of FIG. 9.

FIG. 11 is a front elevation view of the climbing wall of FIG. 9.

FIG. 12 is a back elevation view of the climbing wall of FIG. 9.

FIG. 13 is a right side elevation view of the climbing wall of FIG. 9.

FIG. 14 is a left side elevation view of the climbing wall of FIG. 9.

FIG. 15 is a top plan view of the climbing wall of FIG. 9.

FIG. 16 is a bottom plan view of the climbing wall of FIG. 9.

FIG. 17 is a perspective view of a third embodiment of a climbing wall shown in the condition of use according to the new design.

FIG. 18 is another perspective view of the climbing wall of FIG. 17.

FIG. 19 is a front elevation view of the climbing wall of FIG. 17.

FIG. 20 is a back elevation view of the climbing wall of FIG. 17.

FIG. 21 is a right side elevation view of the climbing wall of FIG. 17.

FIG. 22 is a left side elevation view of the climbing wall of FIG. 17.

FIG. 23 is a top plan view of the climbing wall of FIG. 17.

(Continued)

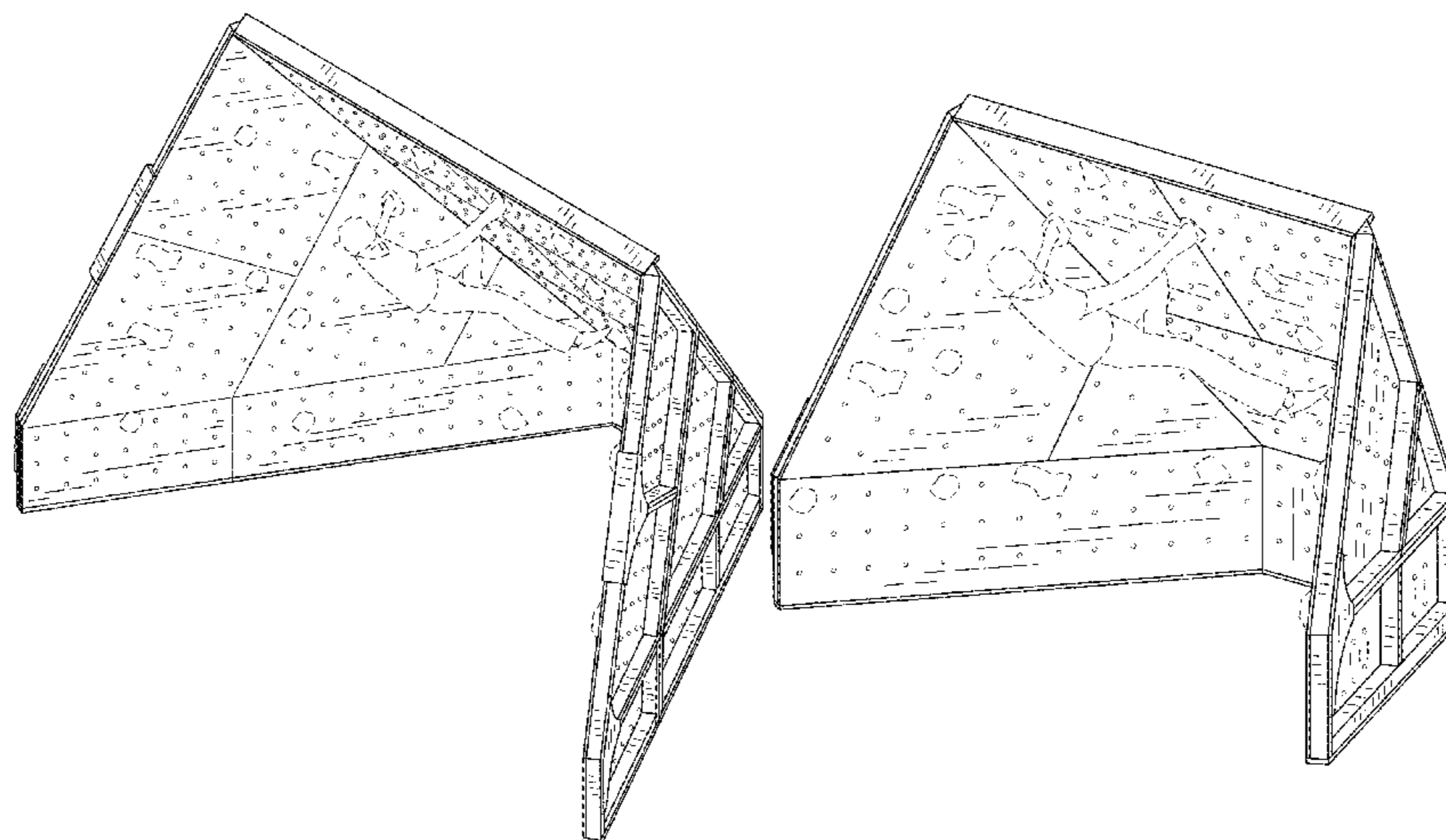

FIG. 24 is a bottom plan view of the climbing wall of FIG. 17.
 FIG. 25 is a perspective view of a fourth embodiment of a climbing wall shown in the condition of use according to the new design.
 FIG. 26 is another perspective view of the climbing wall of FIG. 25.
 FIG. 27 is a front elevation view of the climbing wall of FIG. 25.
 FIG. 28 is a back elevation view of the climbing wall of FIG. 25.
 FIG. 29 is a right side elevation view of the climbing wall of FIG. 25.
 FIG. 30 is a left side elevation view of the climbing wall of FIG. 25.
 FIG. 31 is a top plan view of the climbing wall of FIG. 25.
 FIG. 32 is a bottom plan view of the climbing wall of FIG. 25.
 FIG. 33 is a perspective view of a fifth embodiment of a climbing wall shown in the condition of use according to the new design.
 FIG. 34 is another perspective view of the climbing wall of FIG. 33.
 FIG. 35 is a front elevation view of the climbing wall of FIG. 33.
 FIG. 36 is a back elevation view of the climbing wall of FIG. 33.
 FIG. 37 is a right side elevation view of the climbing wall of FIG. 33.
 FIG. 38 is a left side elevation view of the climbing wall of FIG. 33.
 FIG. 39 is a top plan view of the climbing wall of FIG. 33.
 FIG. 40 is a bottom plan view of the climbing wall of FIG. 33.
 FIG. 41 is a perspective view of a sixth embodiment of a climbing wall shown in the condition of use according to the new design.
 FIG. 42 is another perspective view of the climbing wall of FIG. 41.
 FIG. 43 is a front elevation view of the climbing wall of FIG. 41.
 FIG. 44 is a back elevation view of the climbing wall of FIG. 41.
 FIG. 45 is a right side elevation view of the climbing wall of FIG. 41.
 FIG. 46 is a left side elevation view of the climbing wall of FIG. 41.
 FIG. 47 is a top plan view of the climbing wall of FIG. 41.
 FIG. 48 is a bottom plan view of the climbing wall of FIG. 41.
 FIG. 49 is a perspective view of a seventh embodiment of a climbing wall shown in the condition of use according to the new design.

FIG. 50 is another perspective view of the climbing wall of FIG. 49.
 FIG. 51 is a front elevation view of the climbing wall of FIG. 49.
 FIG. 52 is a back elevation view of the climbing wall of FIG. 49.
 FIG. 53 is a right side elevation view of the climbing wall of FIG. 49.
 FIG. 54 is a left side elevation view of the climbing wall of FIG. 49.
 FIG. 55 is a top plan view of the climbing wall of FIG. 49.
 FIG. 56 is a bottom plan view of the climbing wall of FIG. 49.
 FIG. 57 is a perspective view of an eighth embodiment of a climbing wall shown in the condition of use according to the new design.
 FIG. 58 is another perspective view of the climbing wall of FIG. 57.
 FIG. 59 is a front elevation view of the climbing wall of FIG. 57.
 FIG. 60 is a back elevation view of the climbing wall of FIG. 57.
 FIG. 61 is a right side elevation view of the climbing wall of FIG. 57.
 FIG. 62 is a left side elevation view of the climbing wall of FIG. 57.
 FIG. 63 is a top plan view of the climbing wall of FIG. 57; and,
 FIG. 64 is a bottom plan view of the climbing wall of FIG. 57.
 The broken lines depict portions of the climbing wall that form no part of the claimed design.

1 Claim, 64 Drawing Sheets

(56)

References Cited

U.S. PATENT DOCUMENTS

D404,091	S *	1/1999	Nizza	D21/505
D587,765	S *	3/2009	Dawes	D21/505
9,650,780	B2 *	5/2017	Tan	E04B 1/2608
2003/0013579	A1 *	1/2003	Rennex	A63B 69/0048
				482/37
2006/0258511	A1 *	11/2006	Postma	A63B 69/0048
				482/37
2018/0353823	A1 *	12/2018	Resnicke	A63B 69/0048
2020/0197783	A1 *	6/2020	Iida	G06F 3/14
2021/0245026	A1 *	8/2021	Sudeith	A63B 69/0048

* cited by examiner

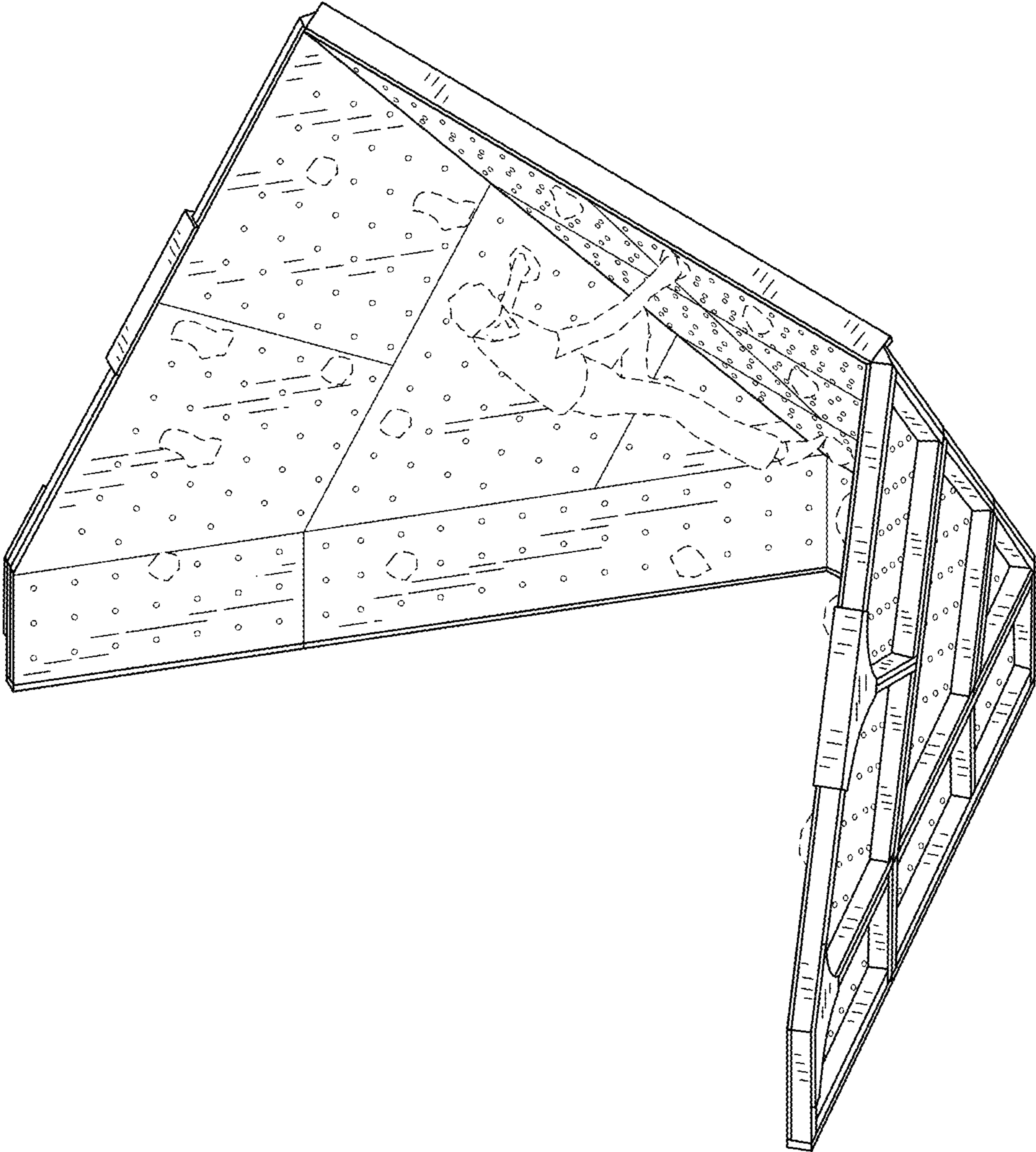

FIG. 1

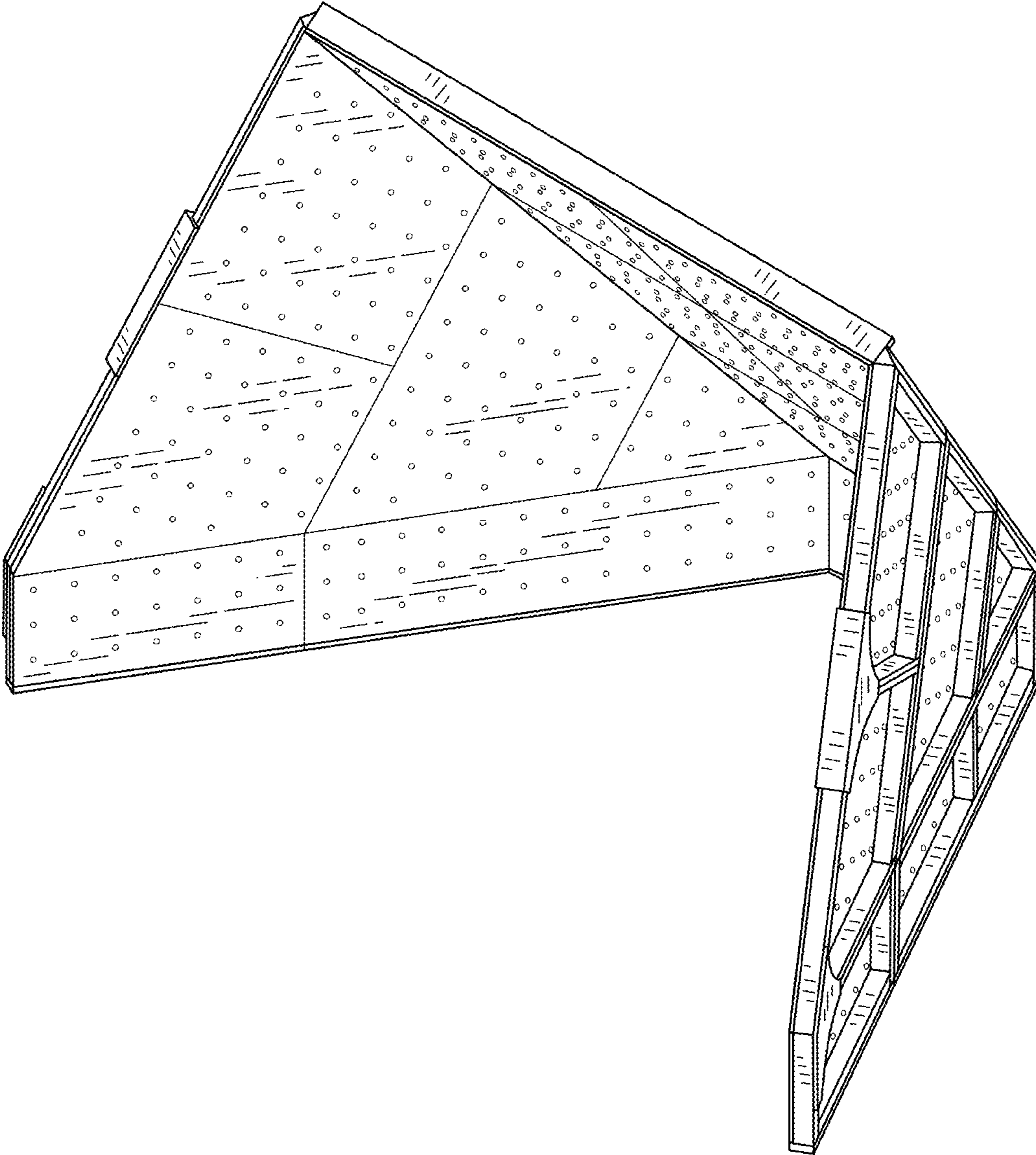

FIG.2

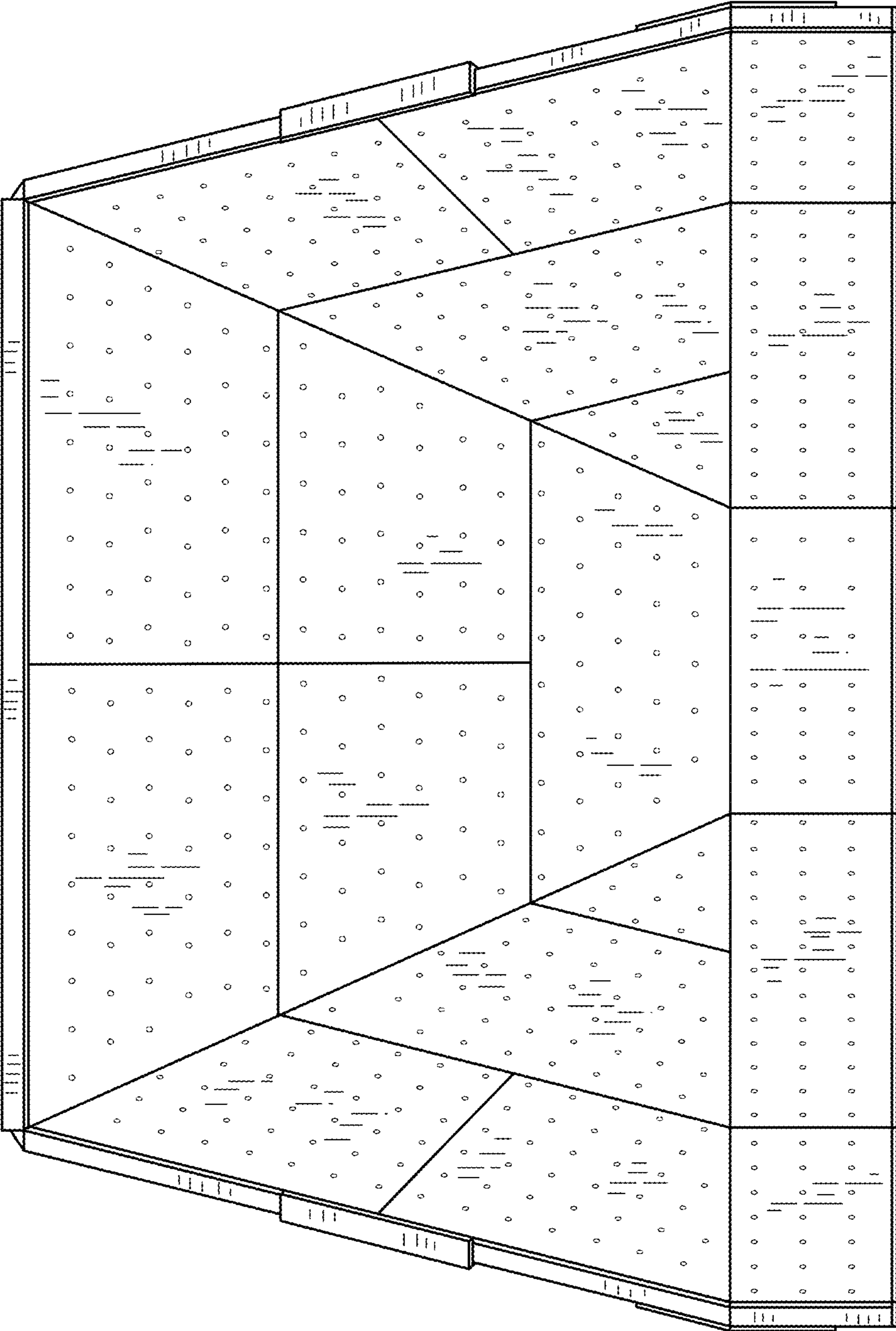

FIG.3

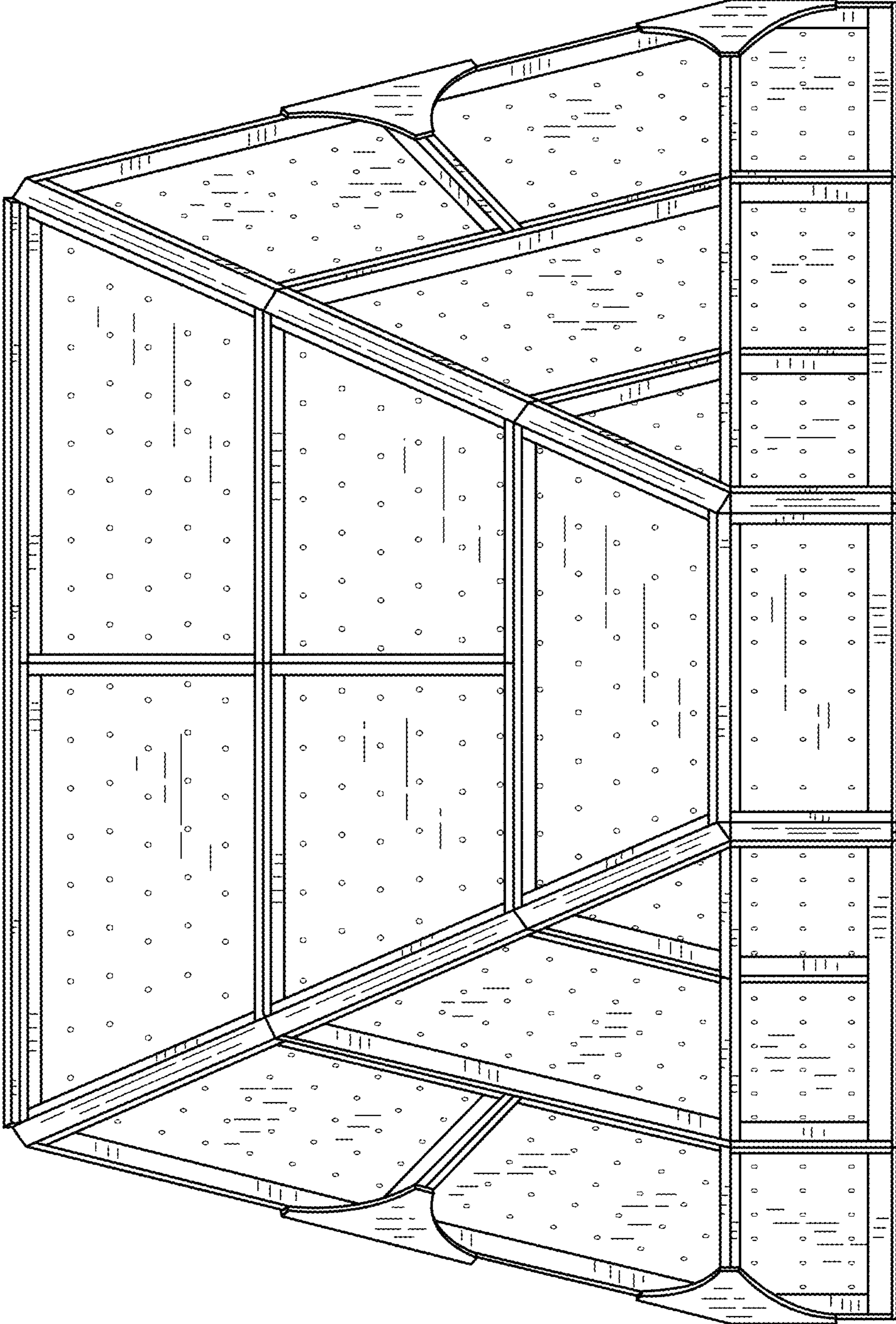

FIG.4

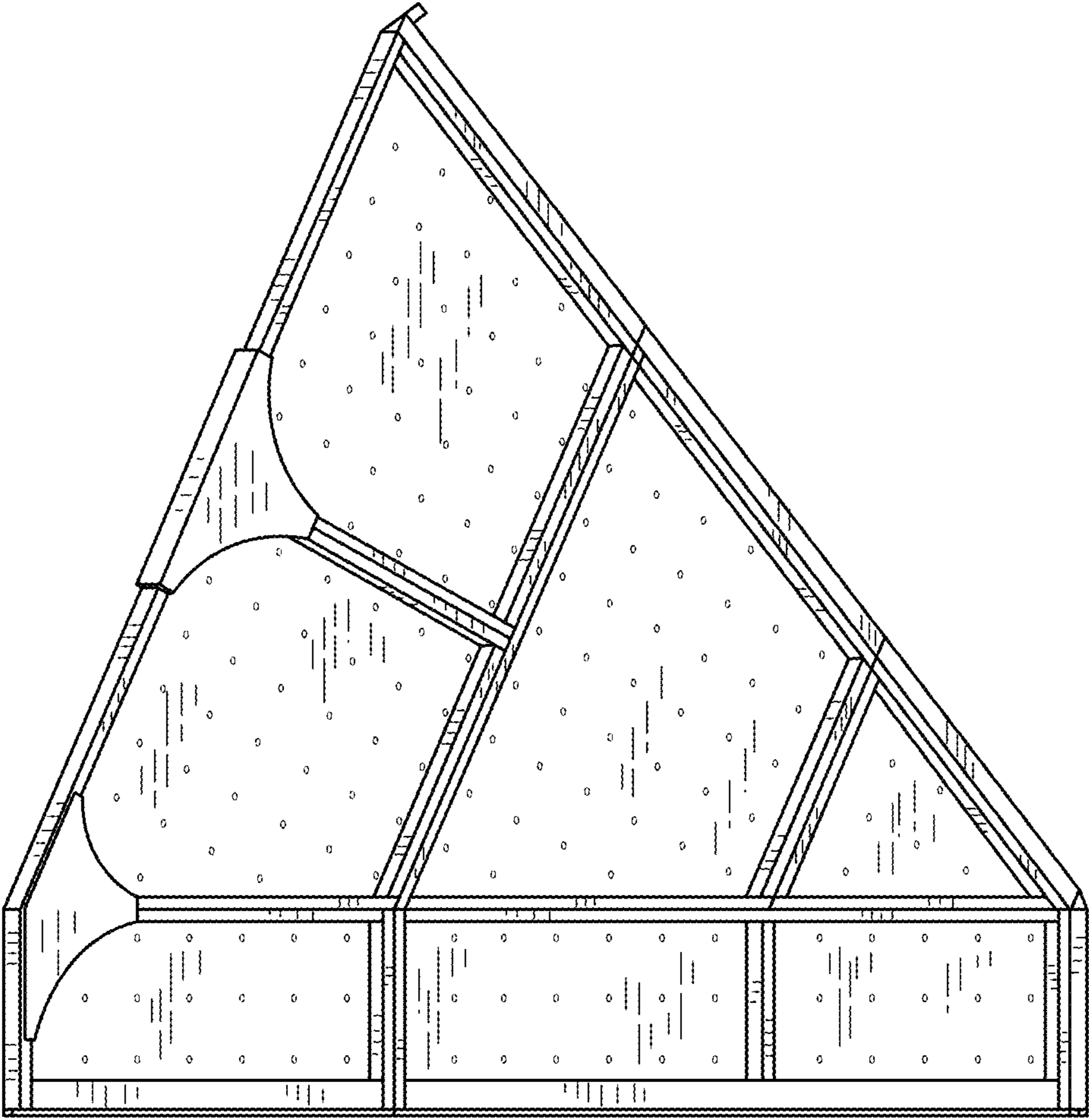

FIG.5

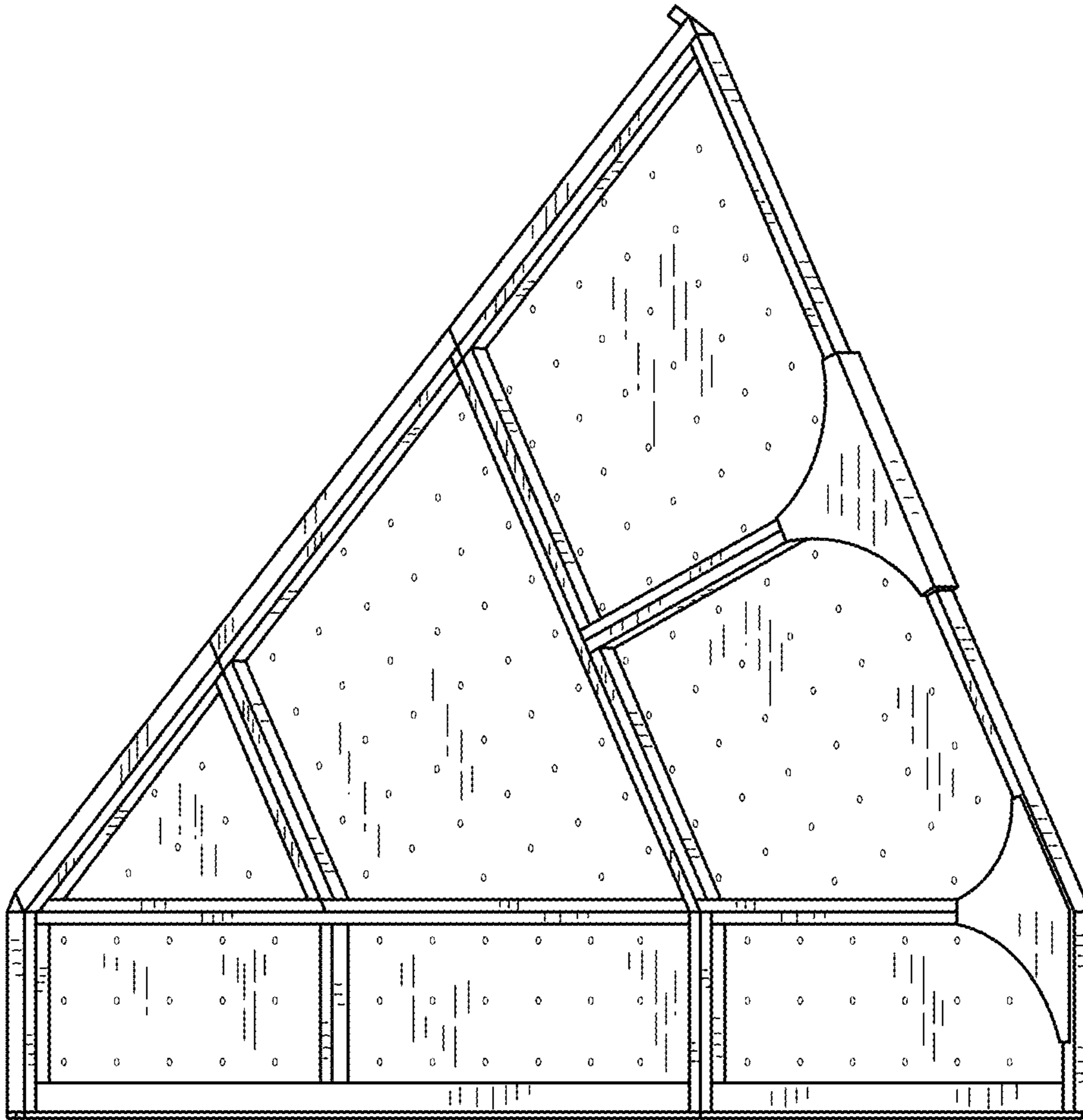

FIG.6

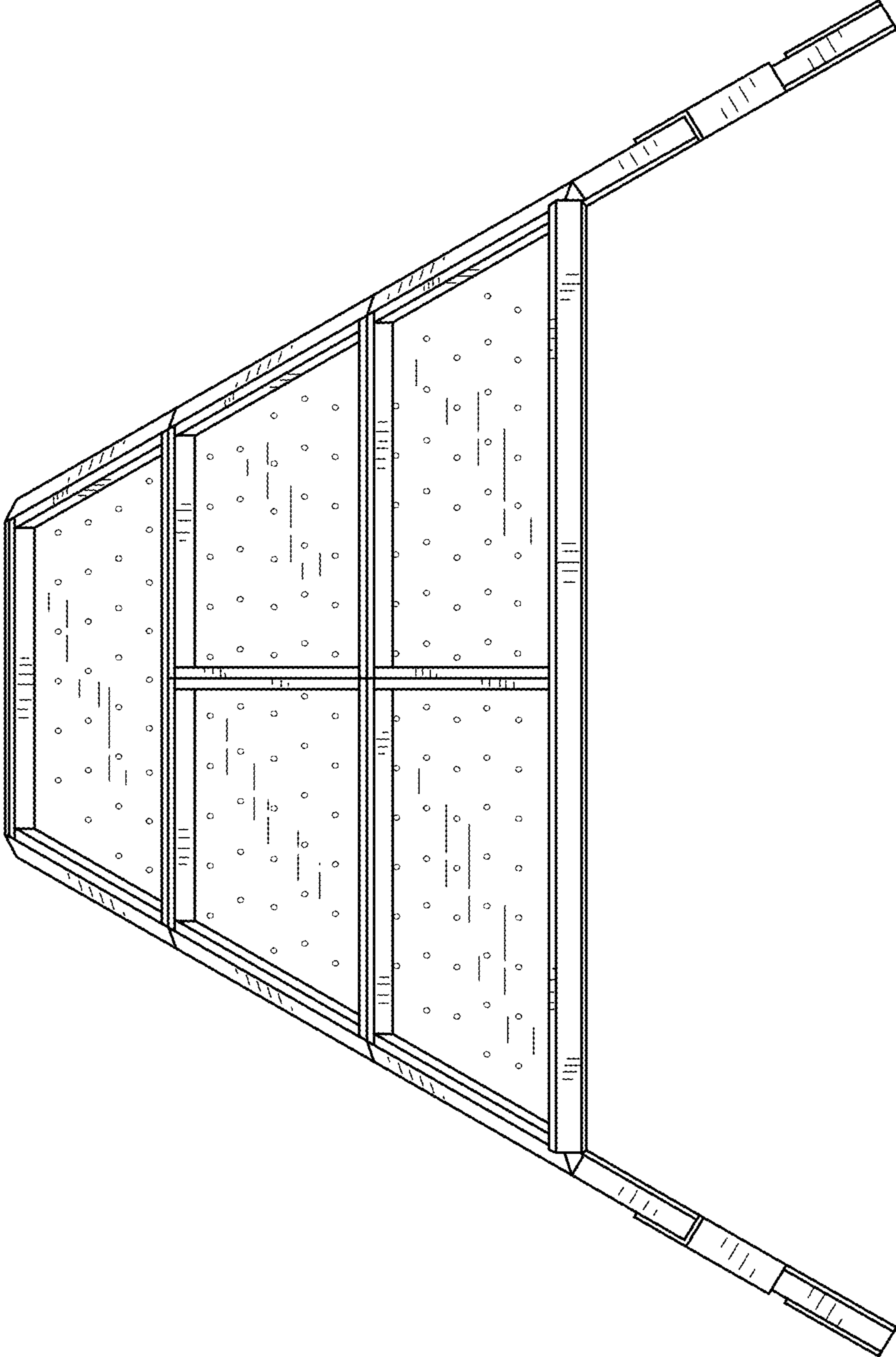

FIG.7

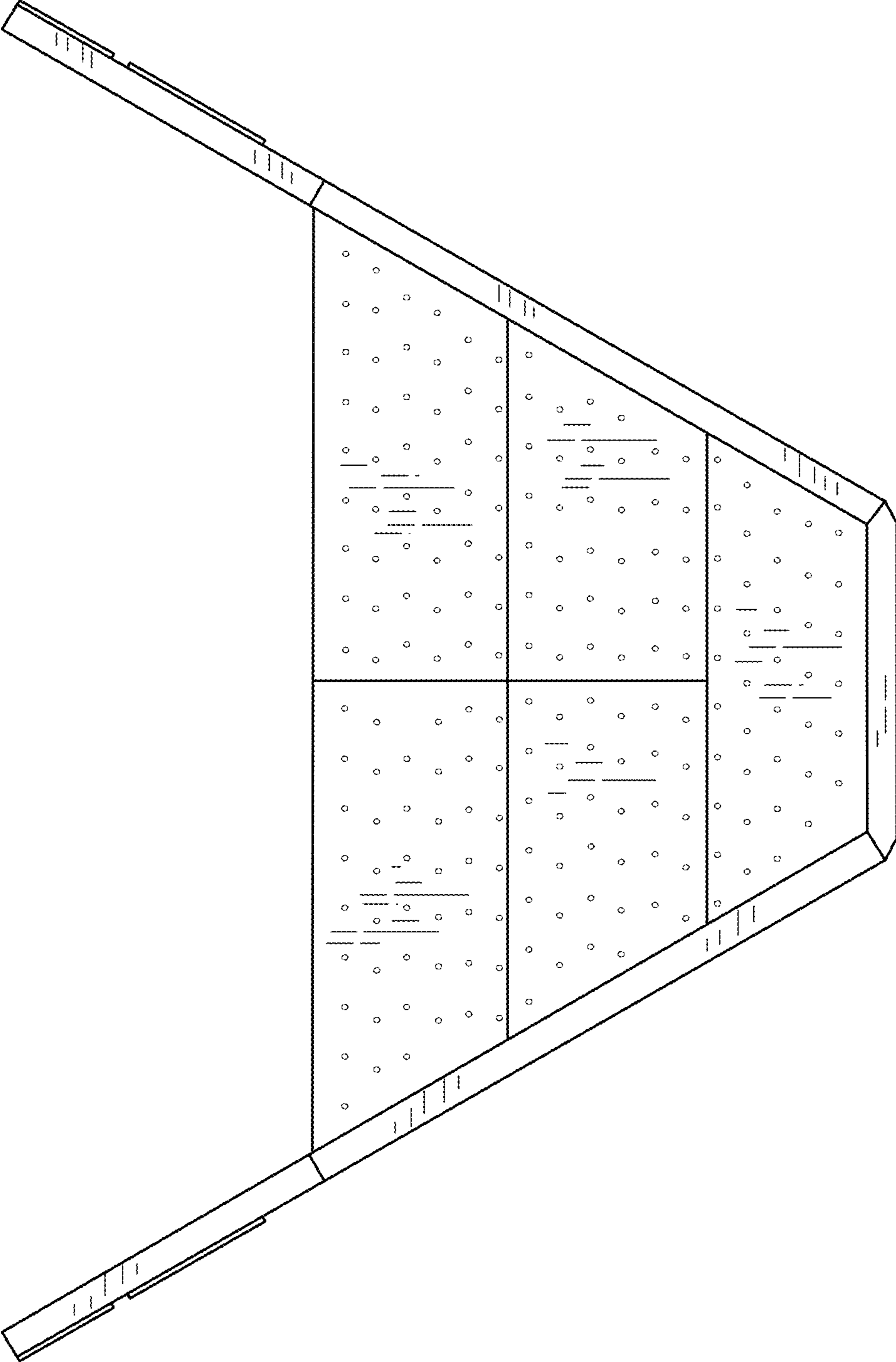

FIG.8

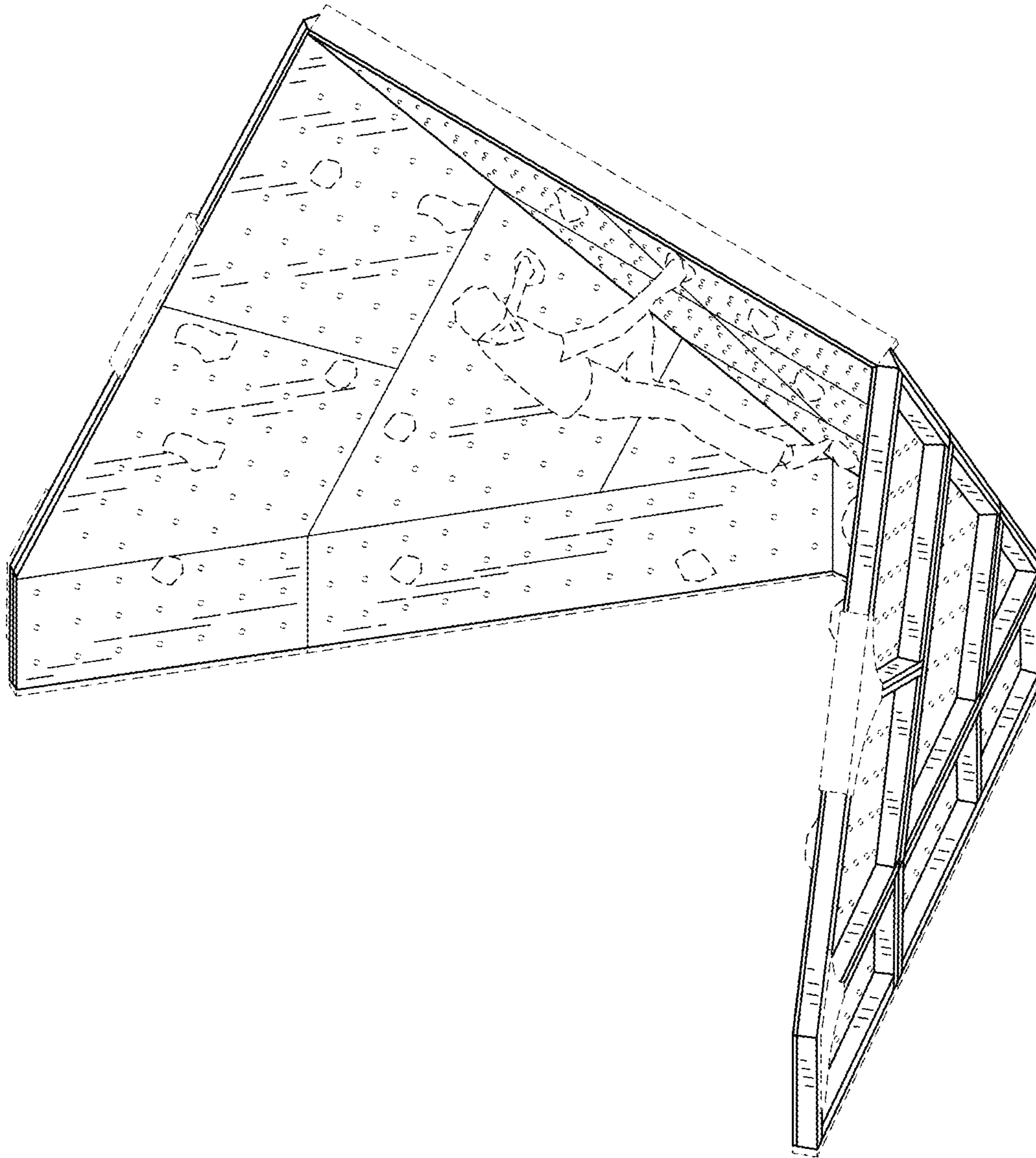

FIG.9

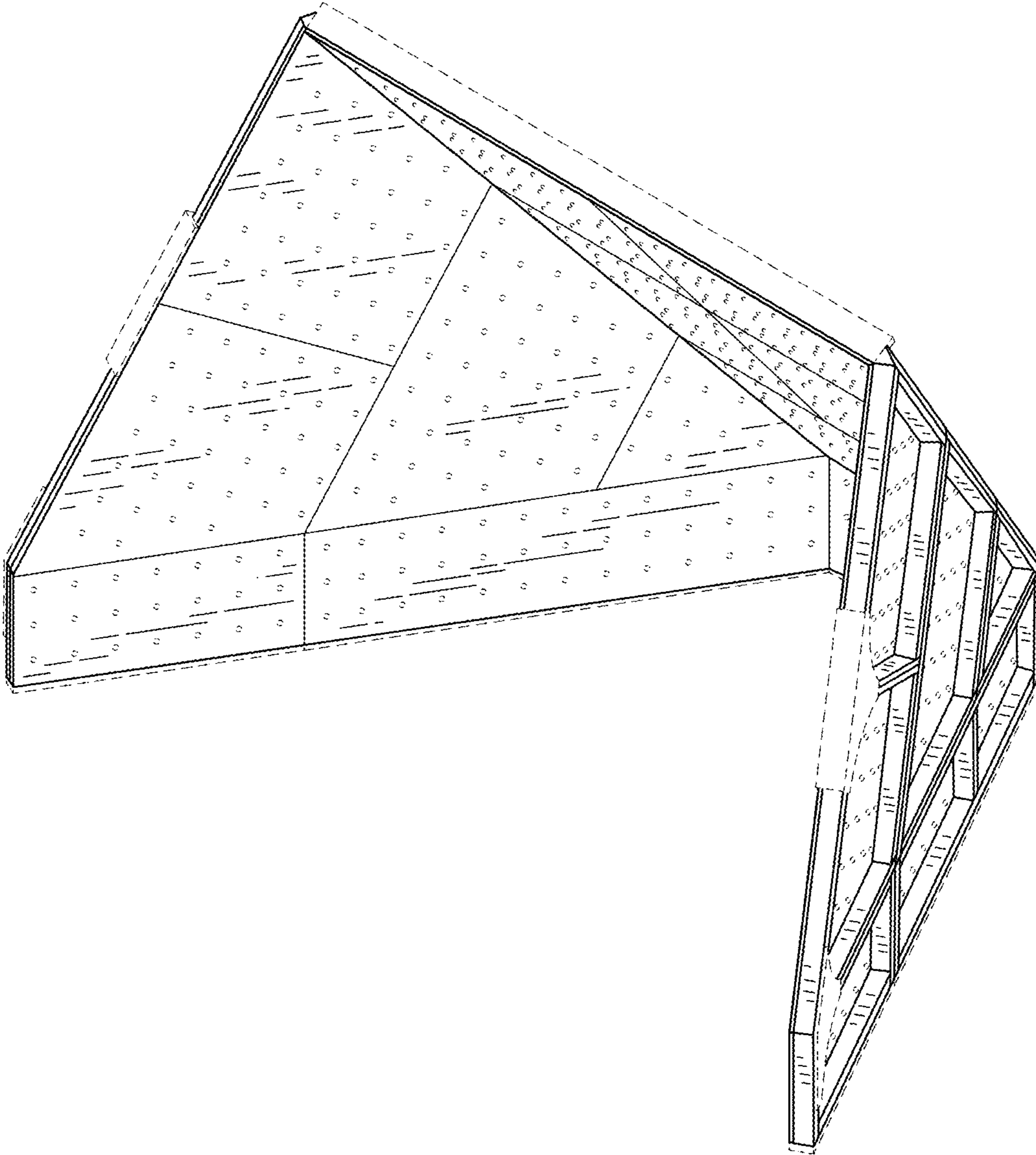

FIG.10

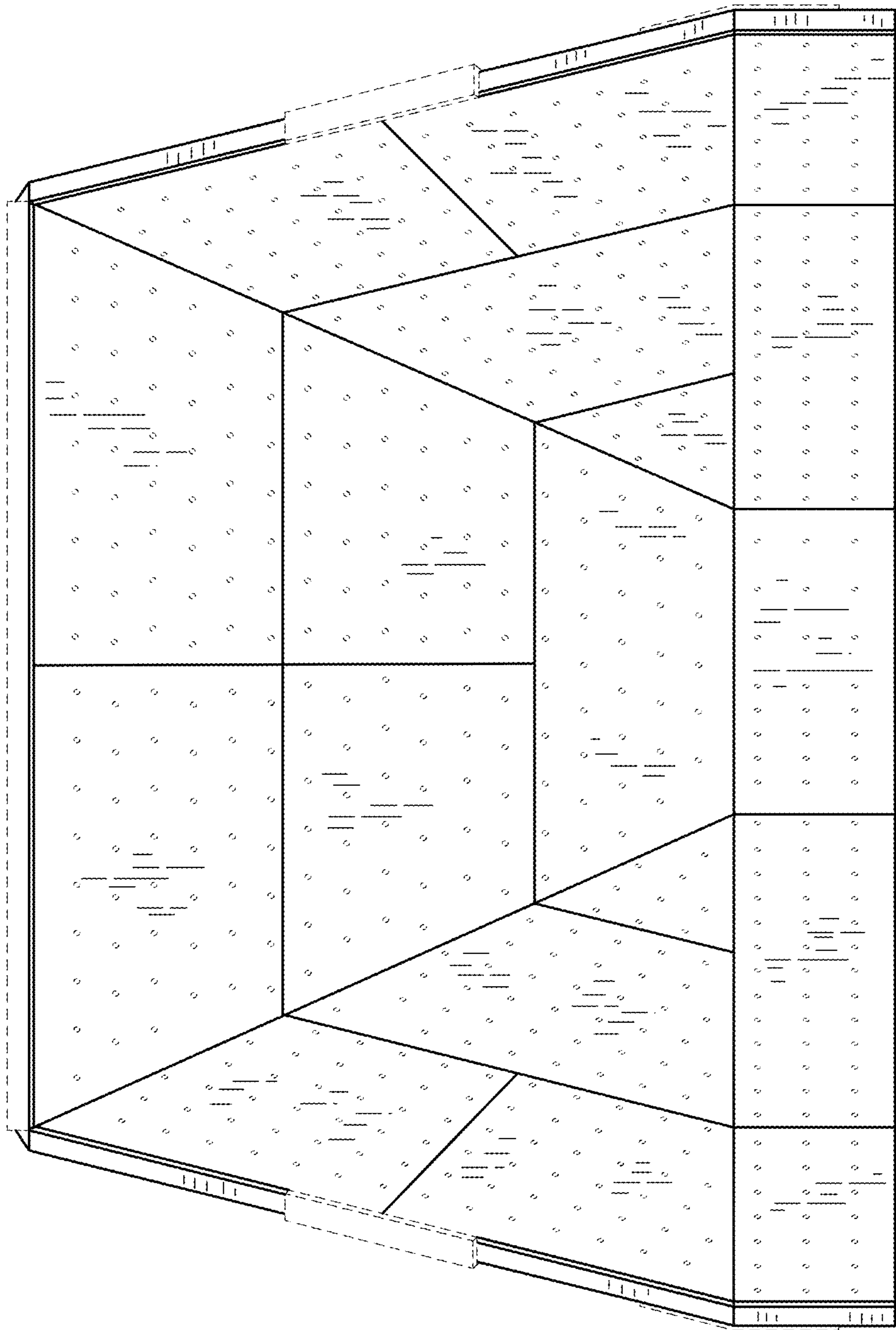

FIG.11

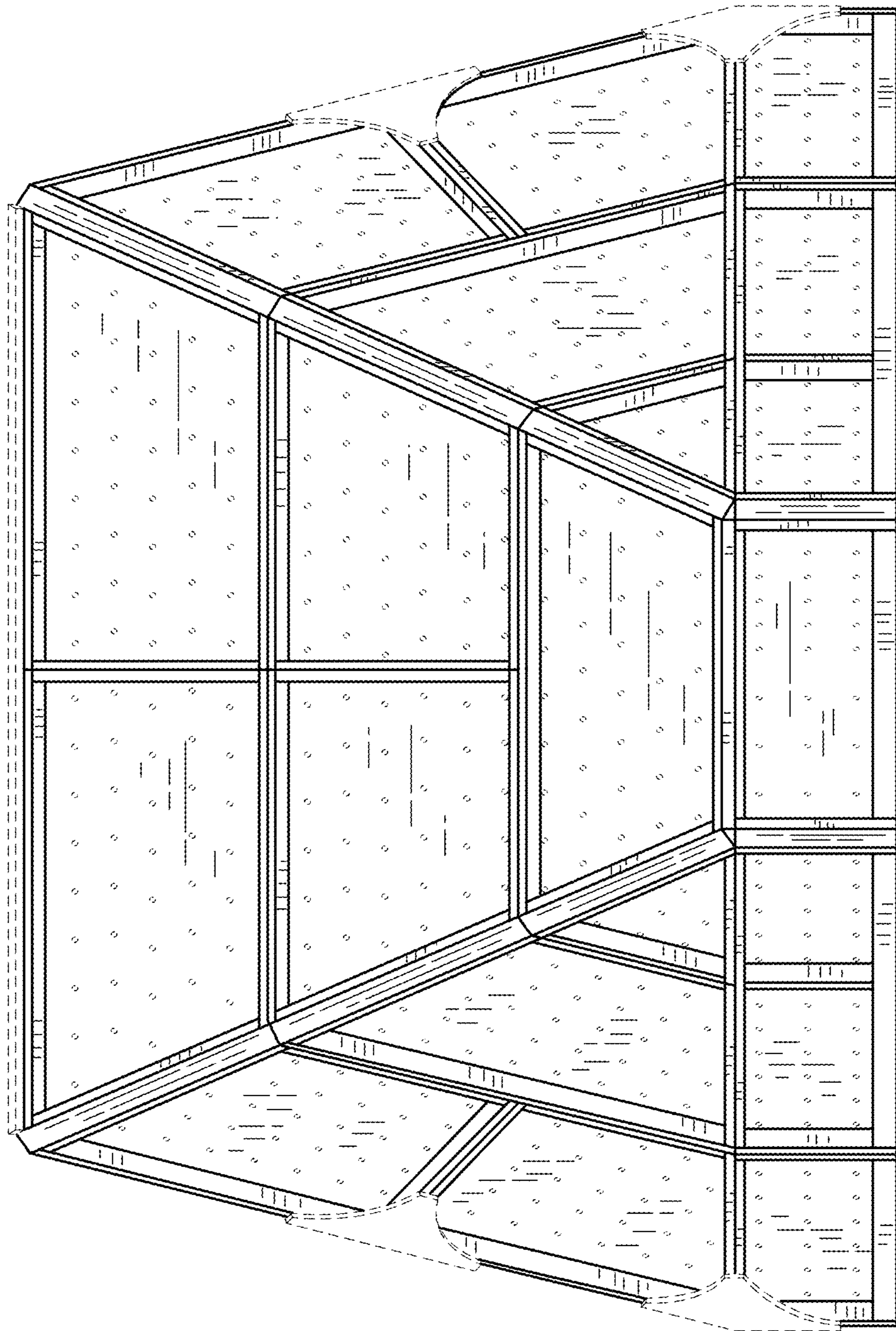

FIG.12

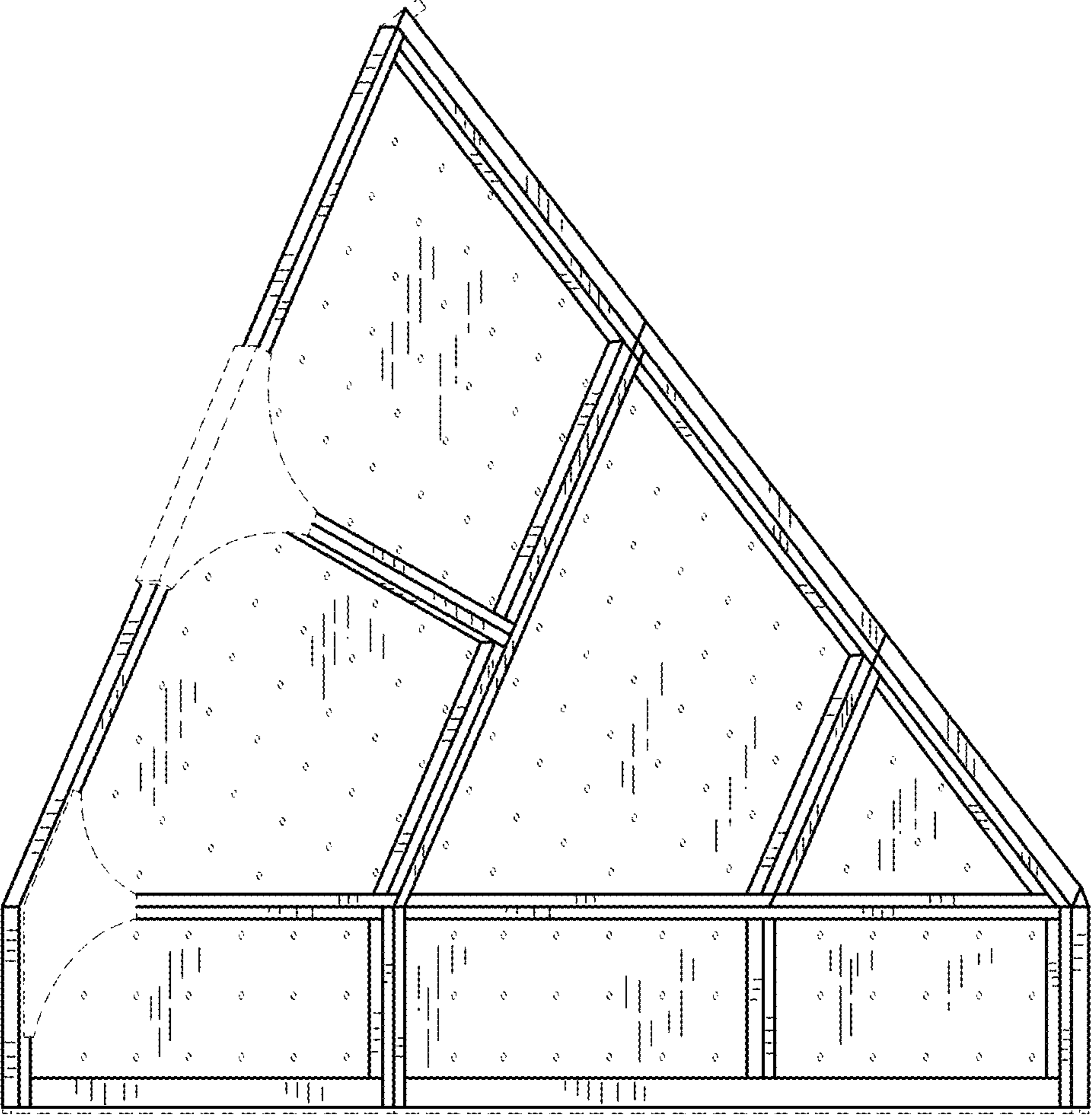

FIG.13

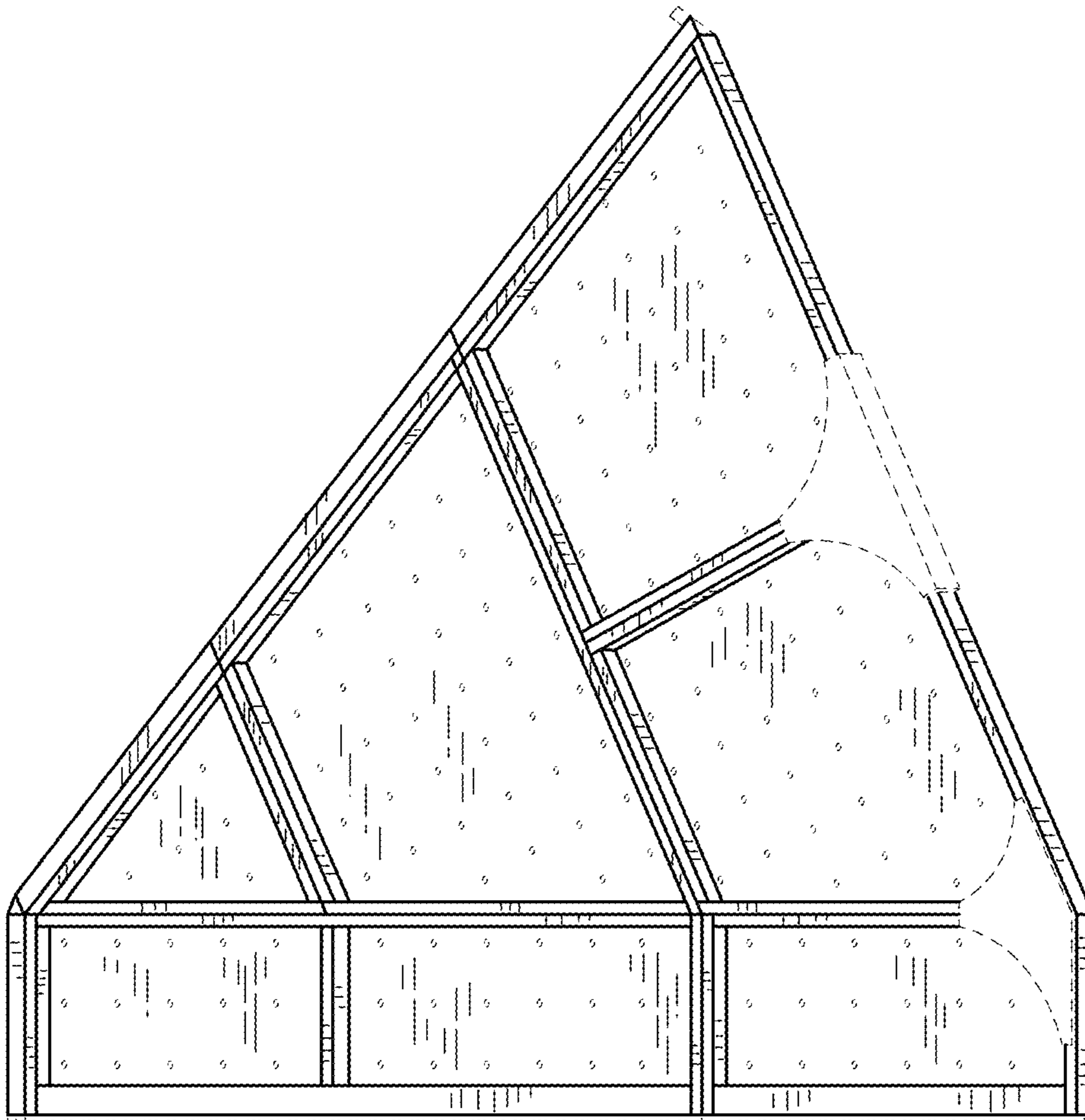

FIG.14

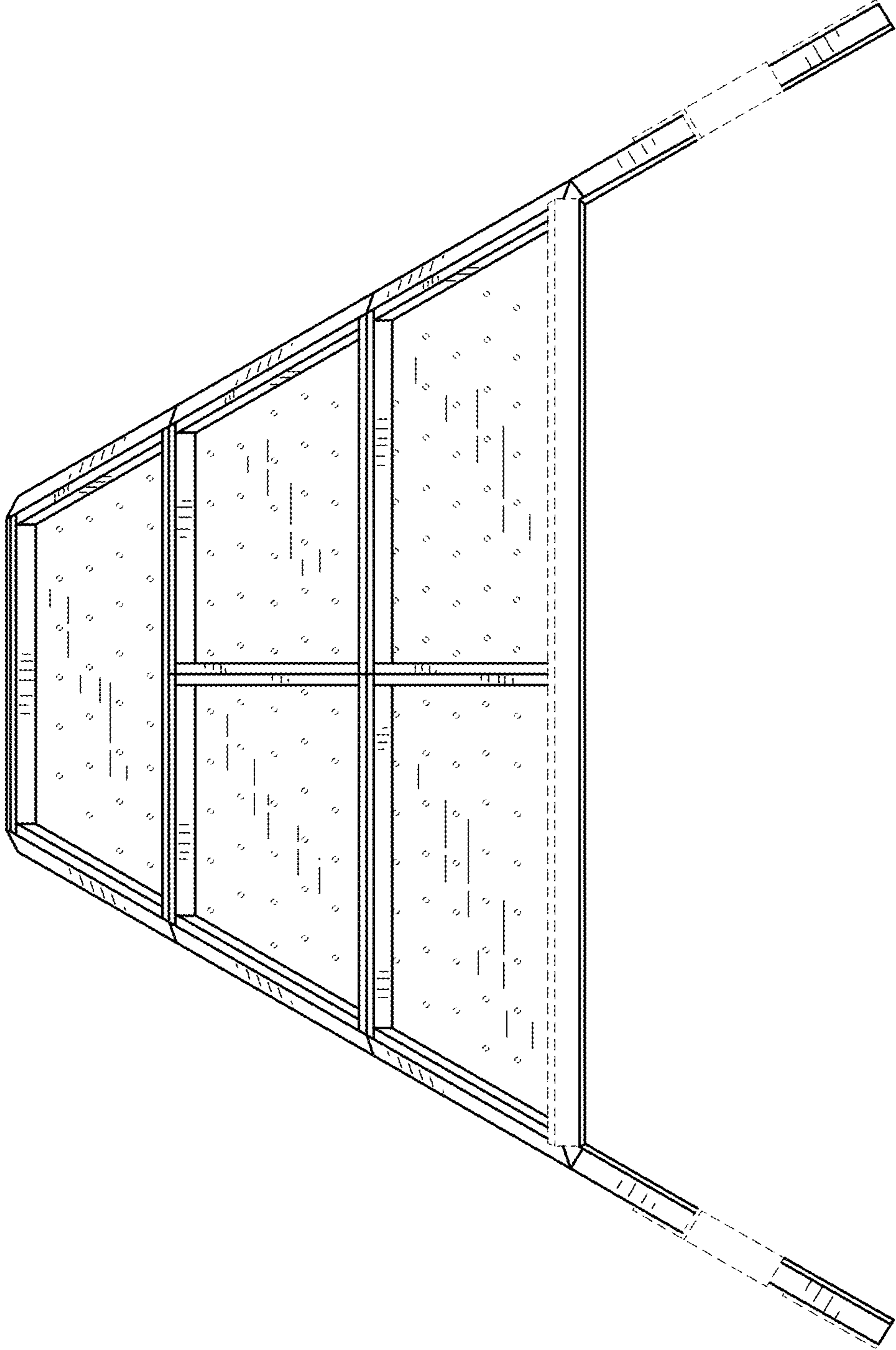

FIG.15

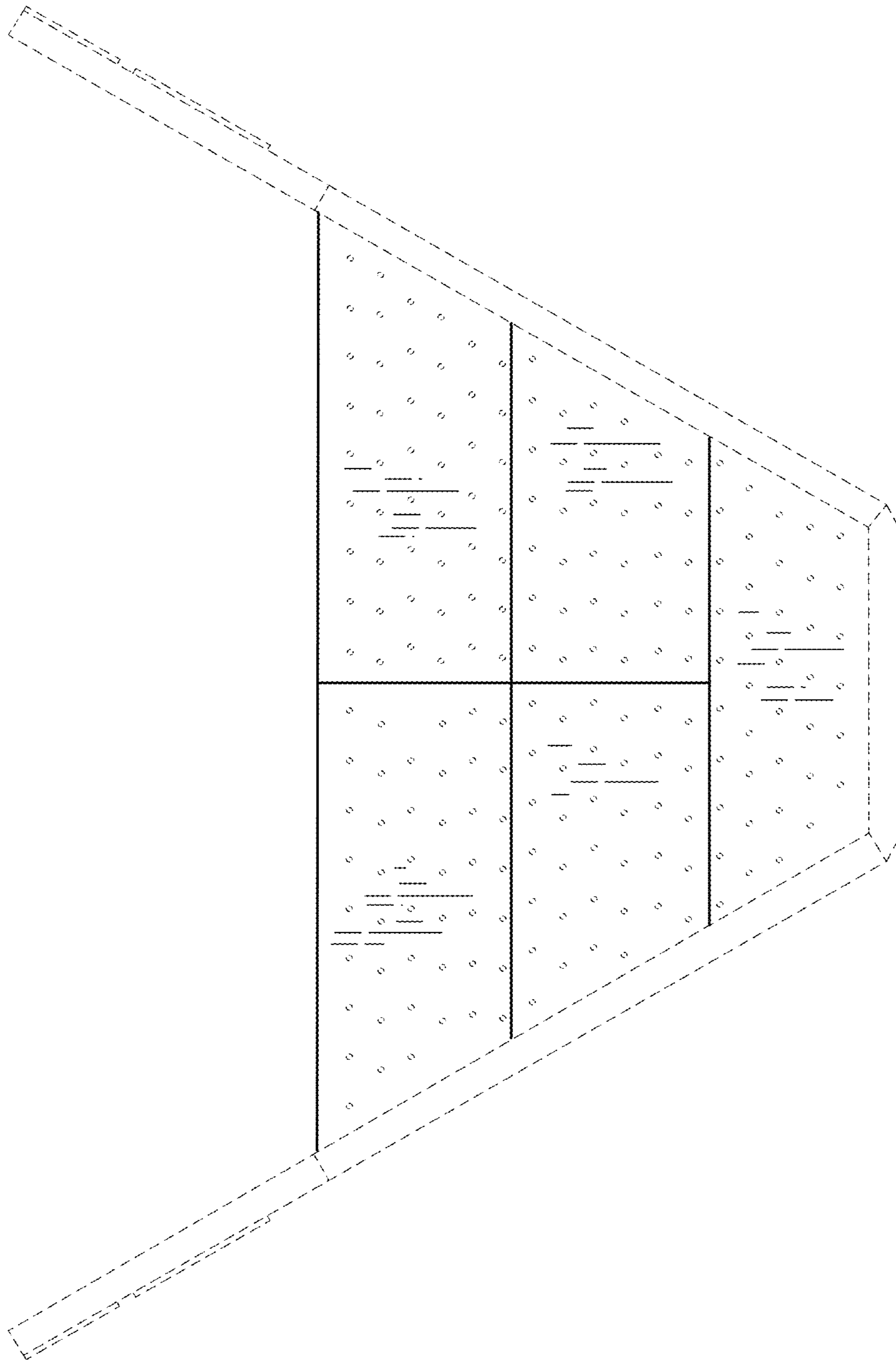

FIG.16

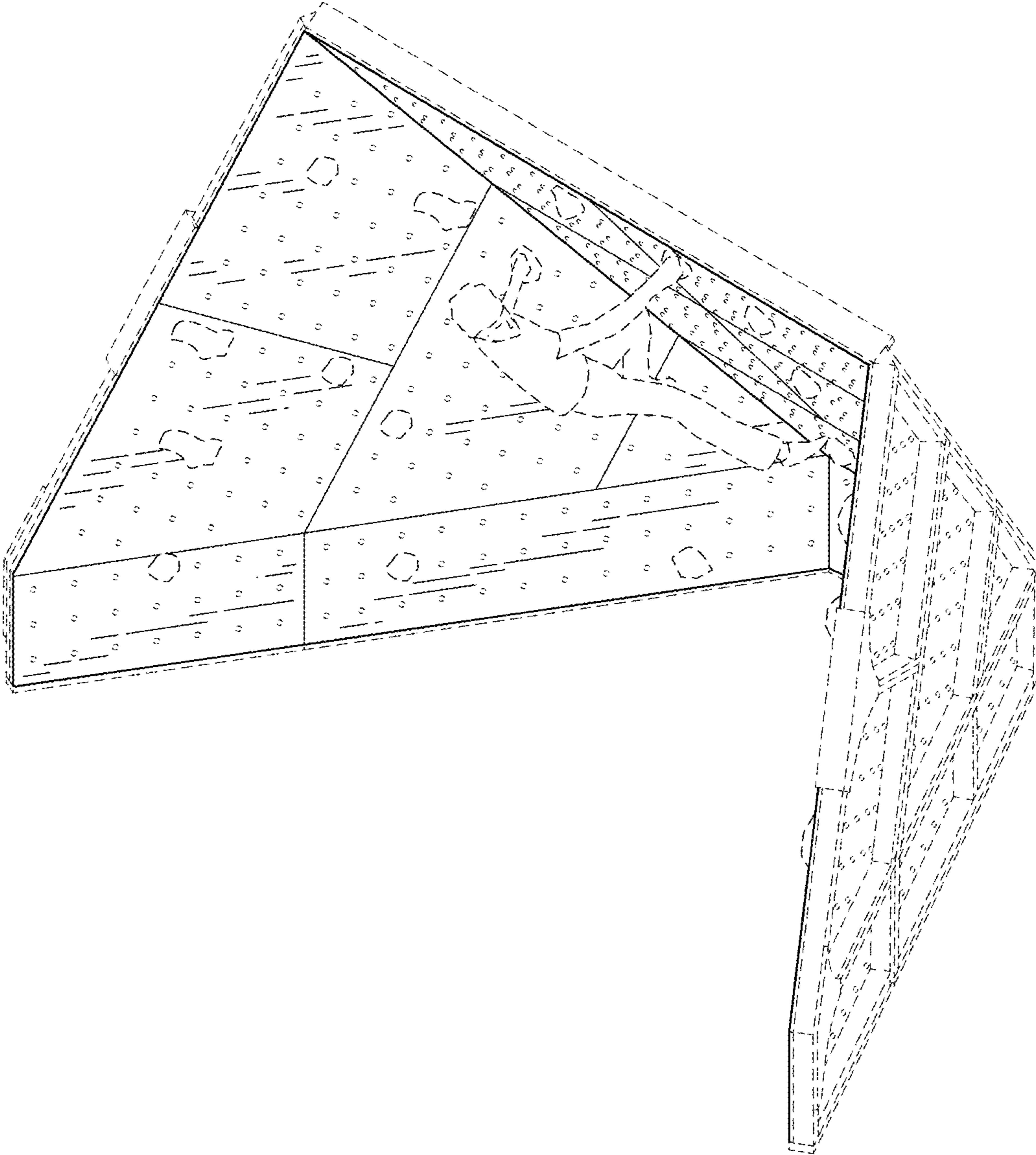

FIG.17

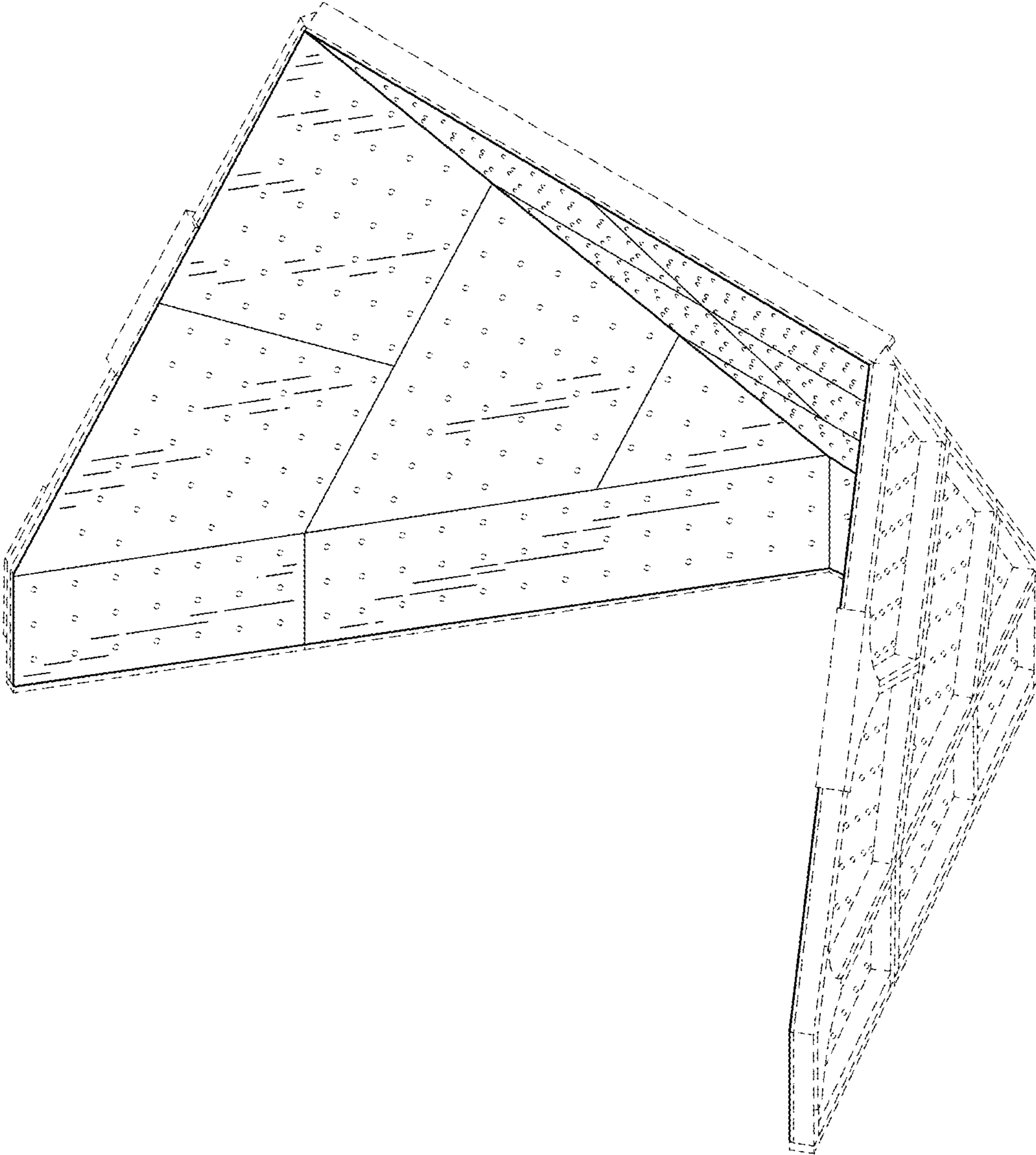

FIG.18

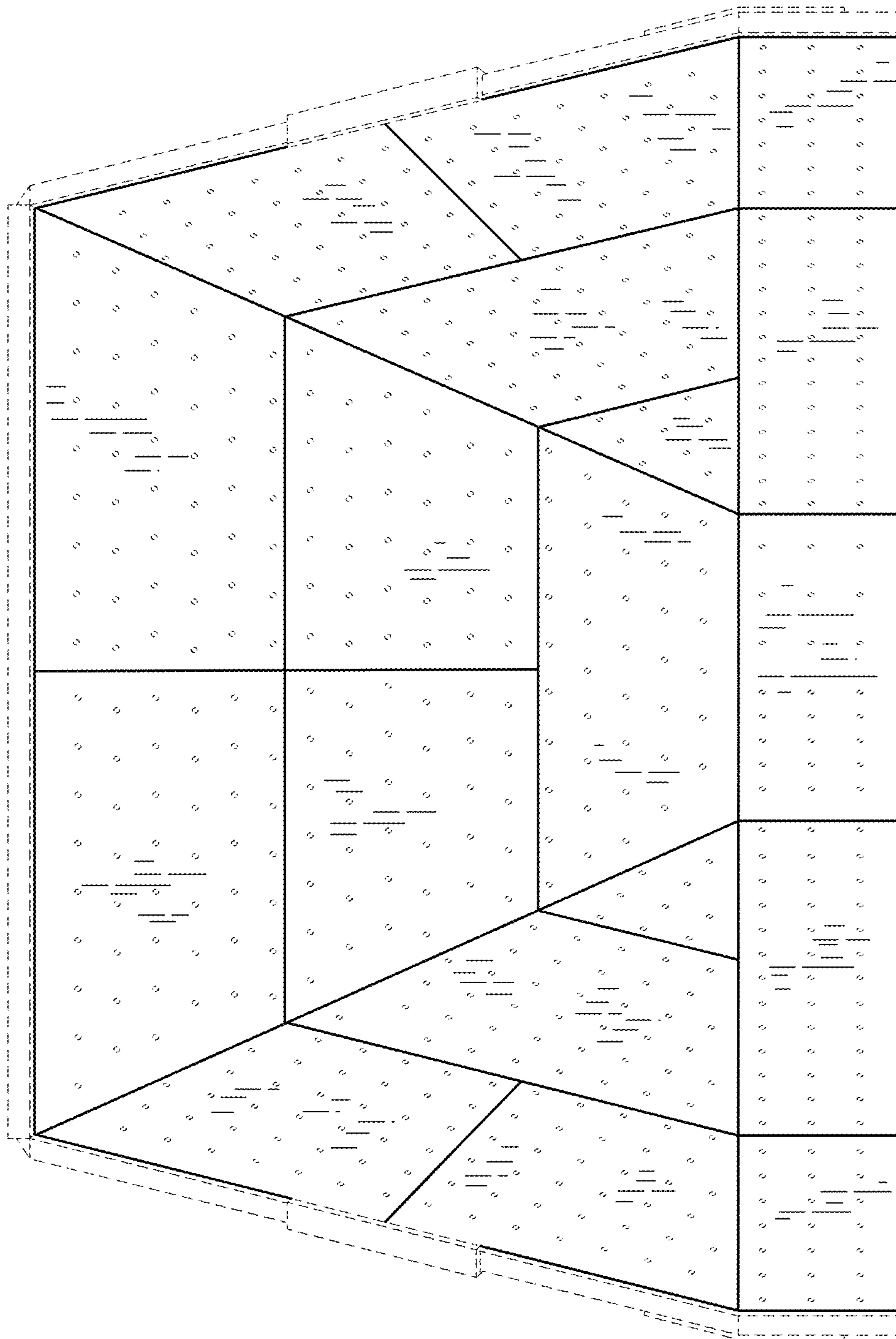

FIG.19

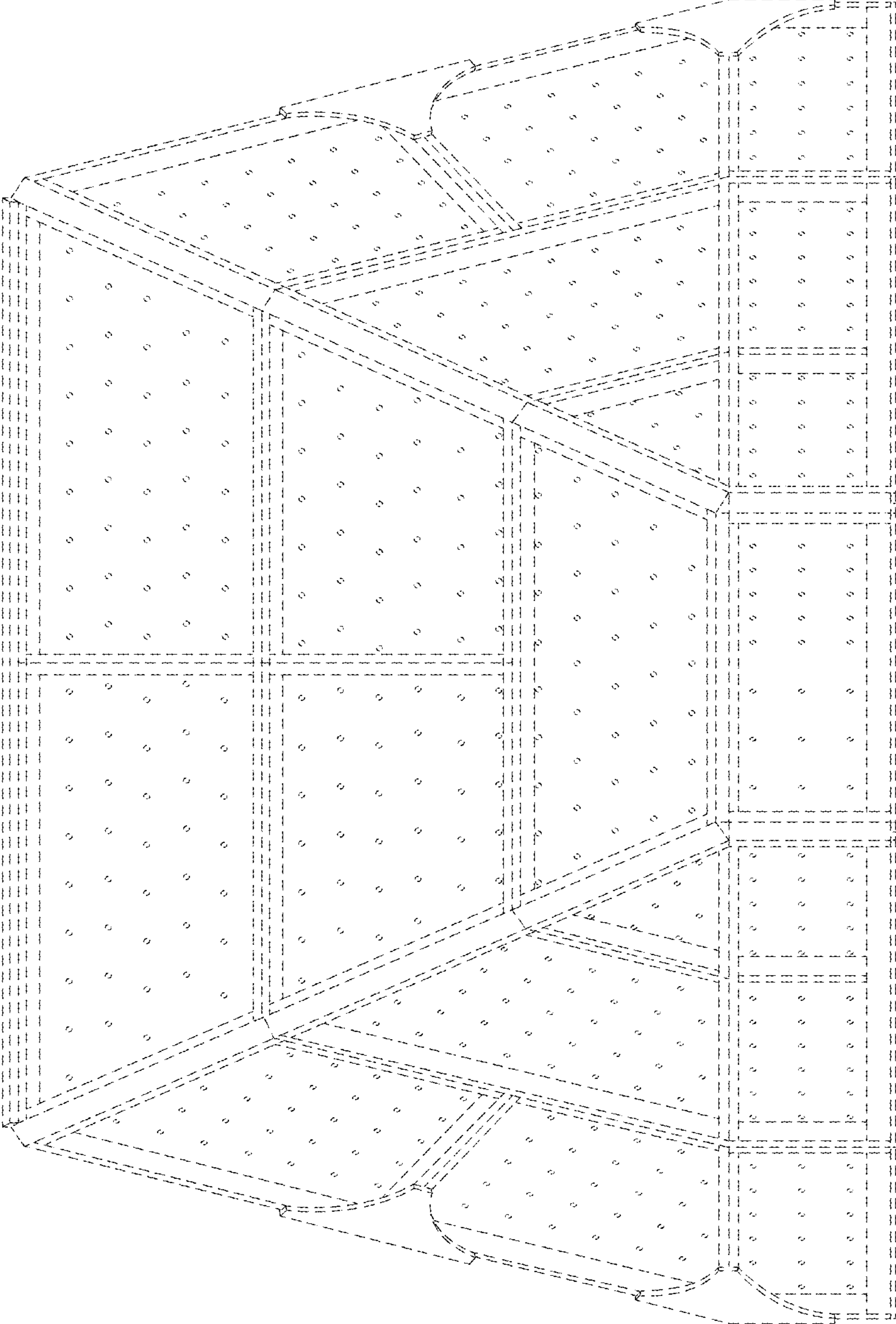

FIG.20

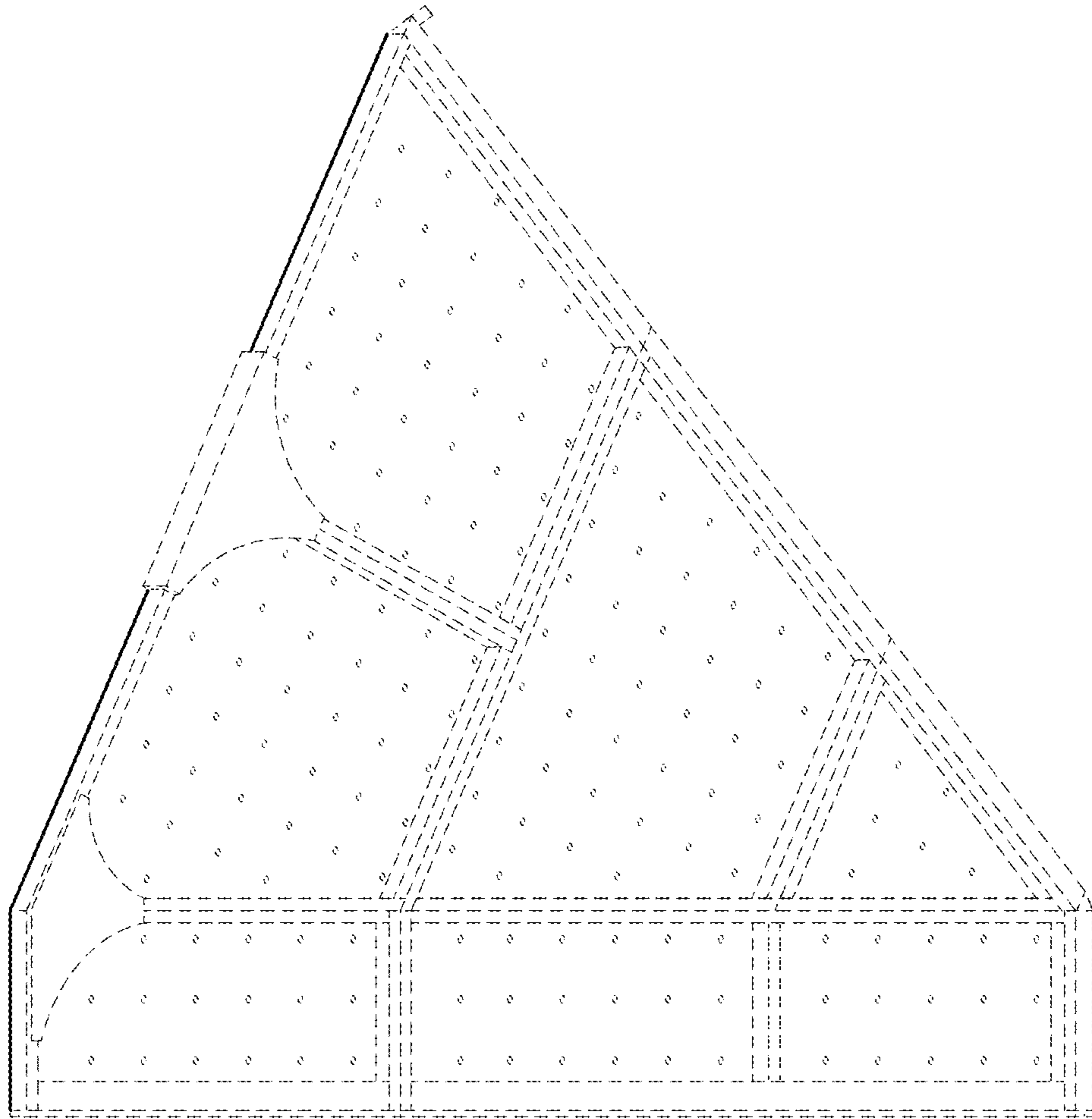

FIG.21

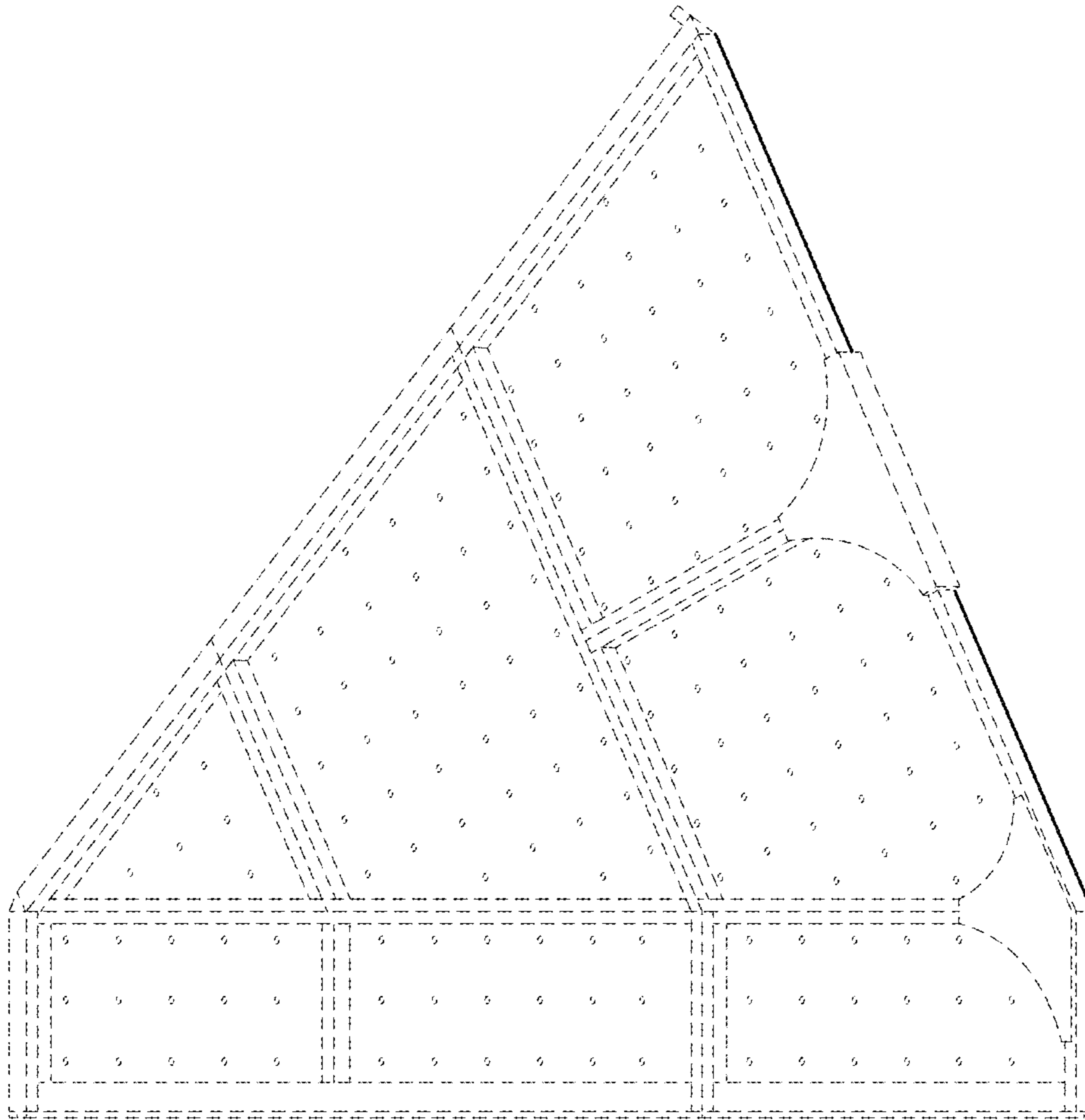

FIG.22

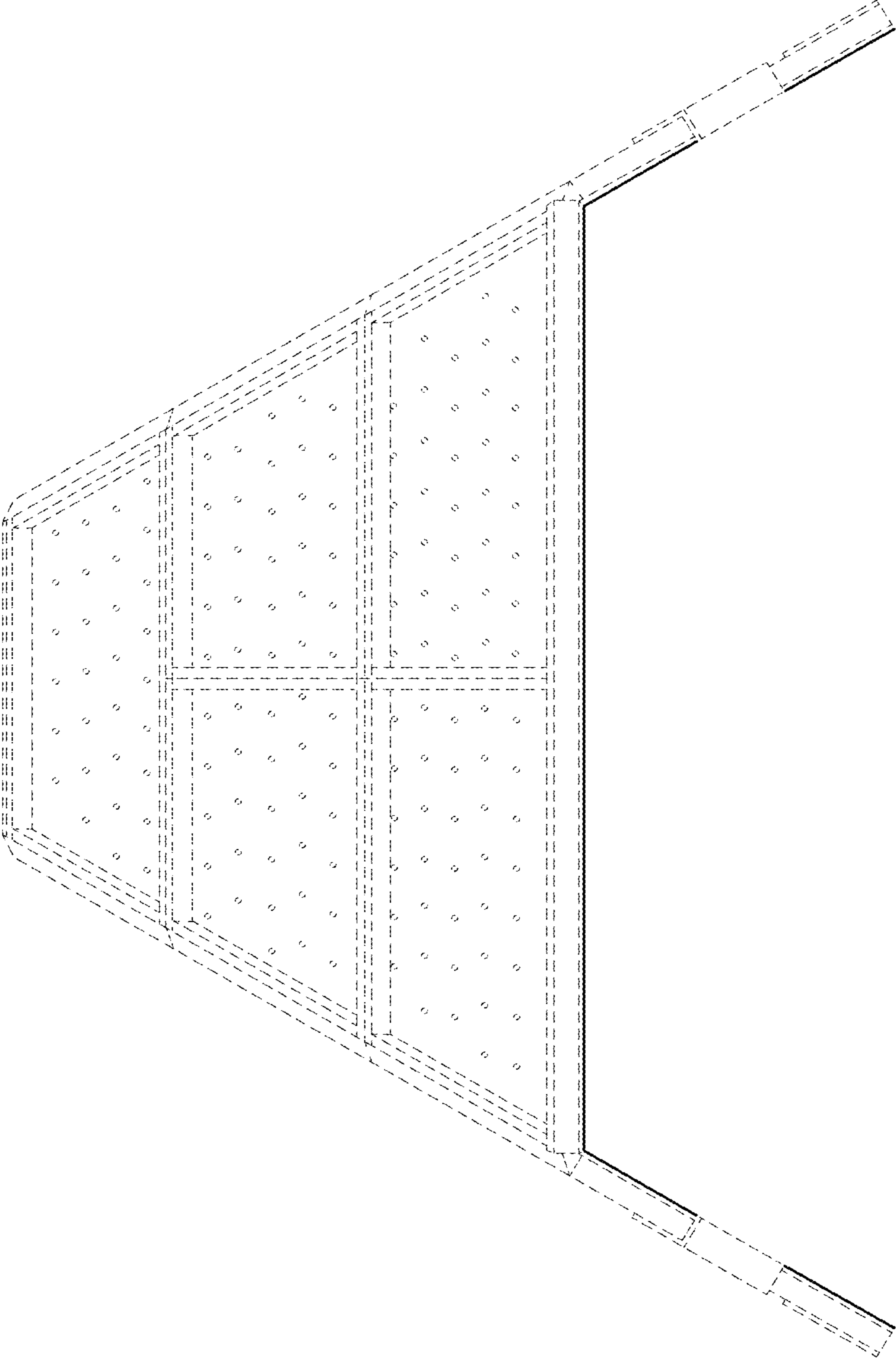

FIG.23

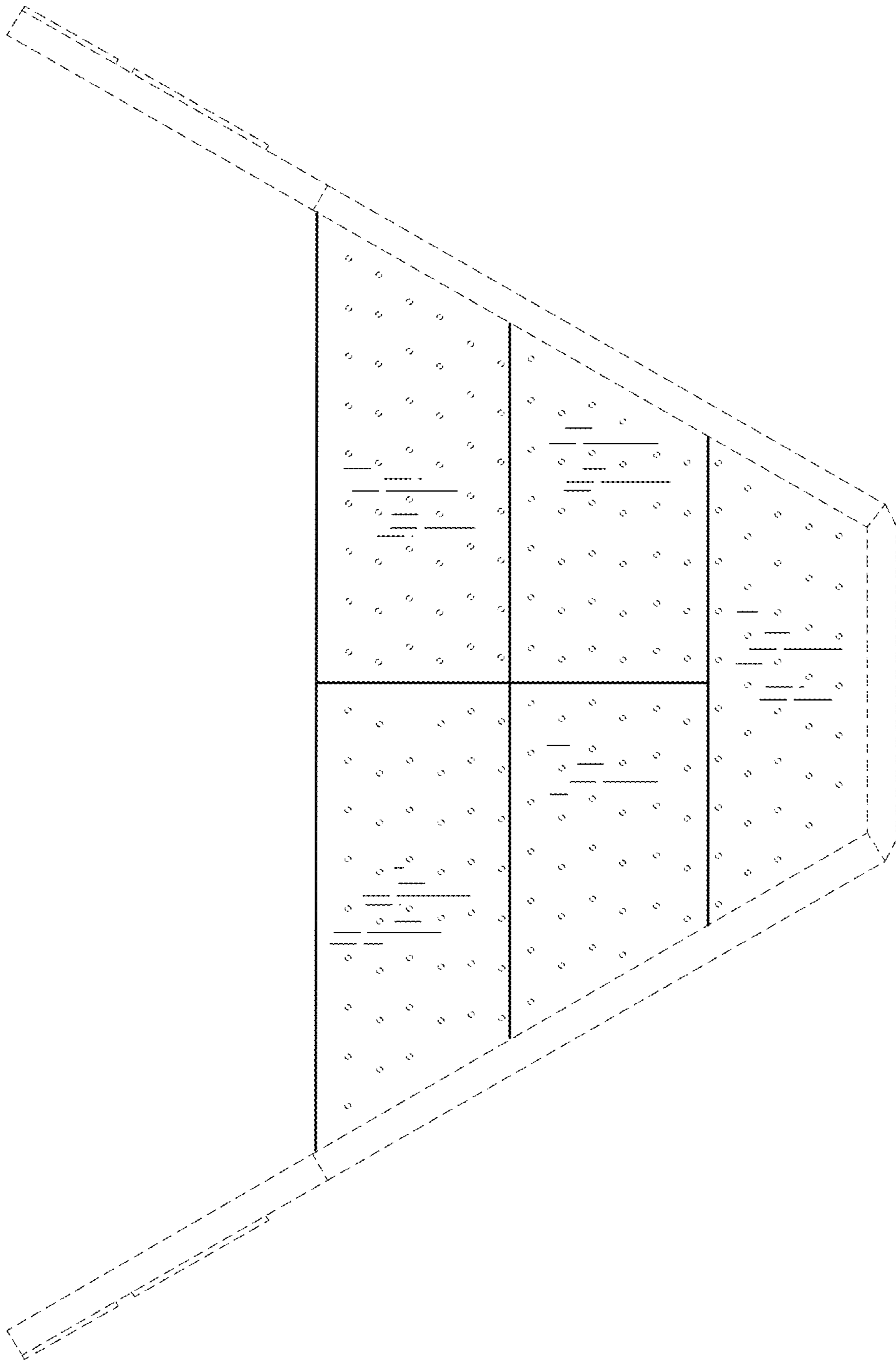

FIG.24

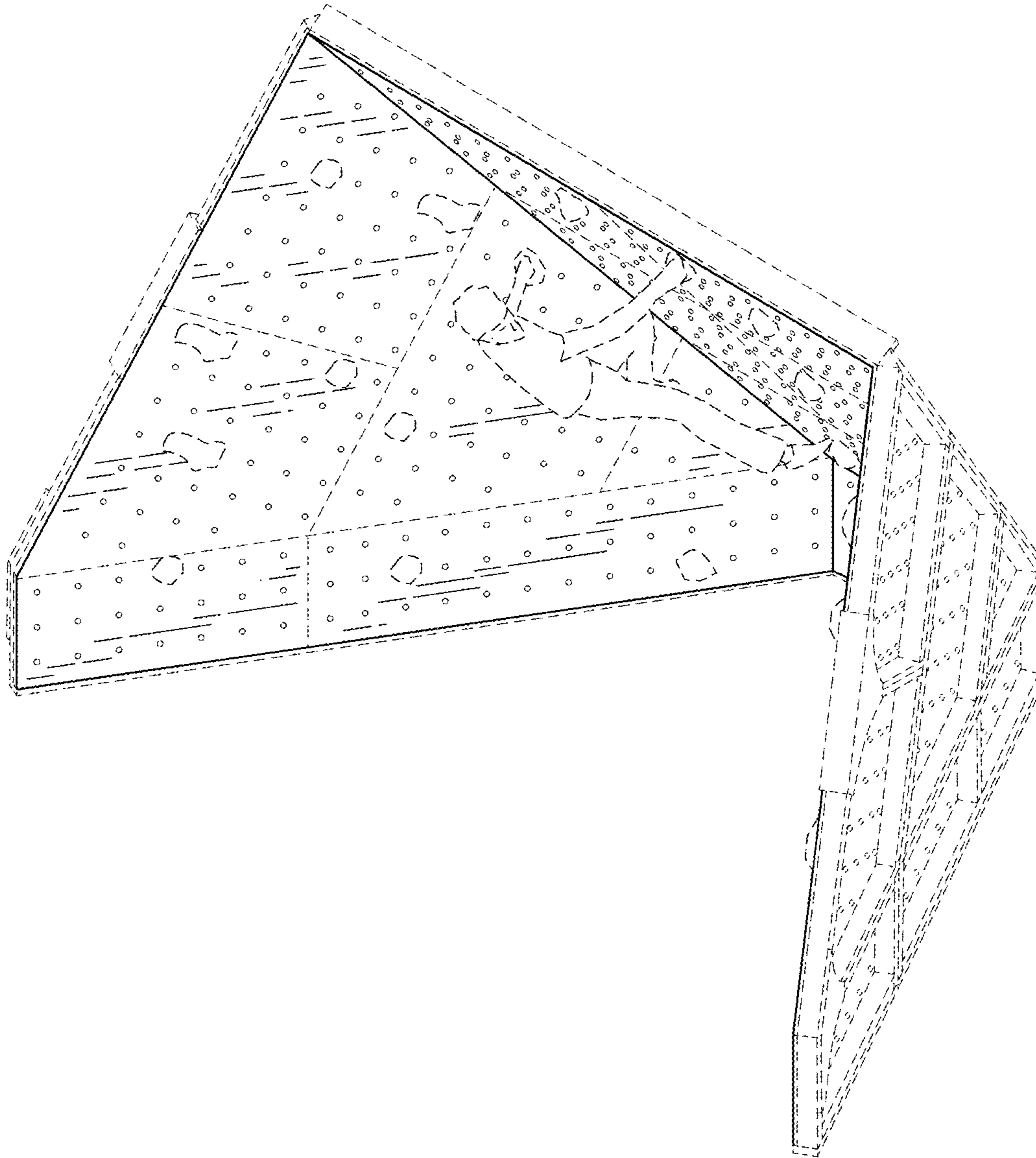

FIG.25

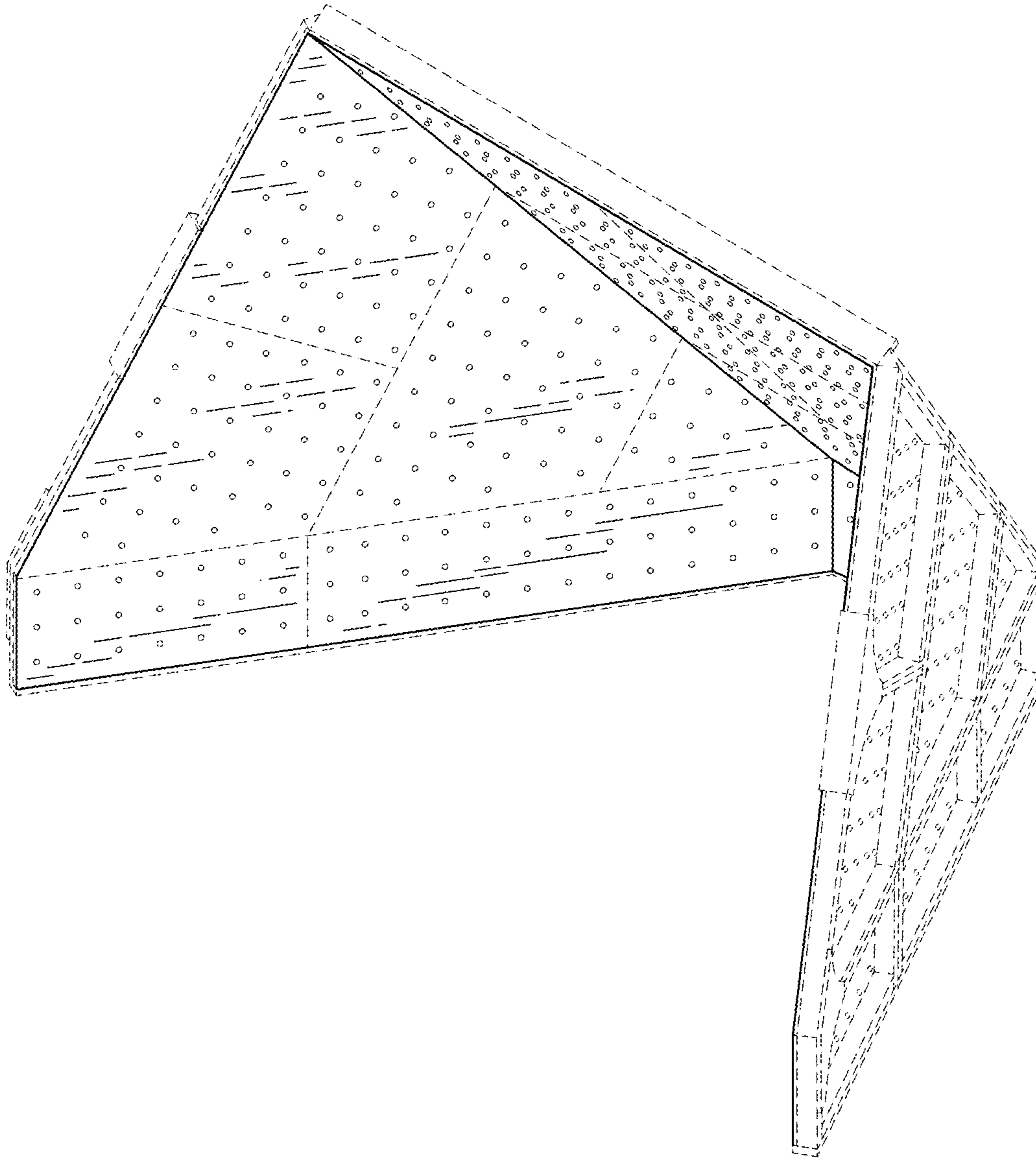

FIG.26

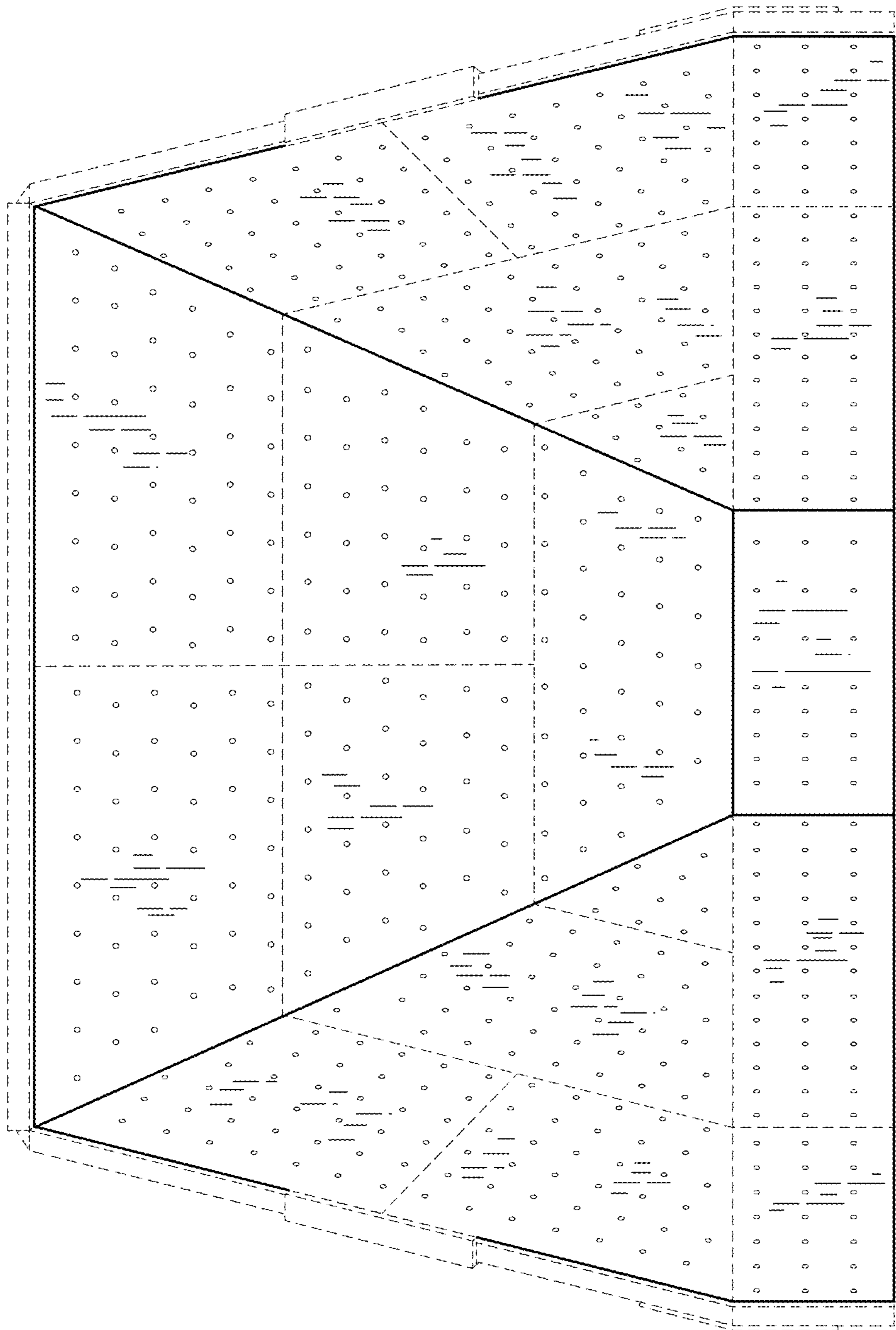

FIG.27

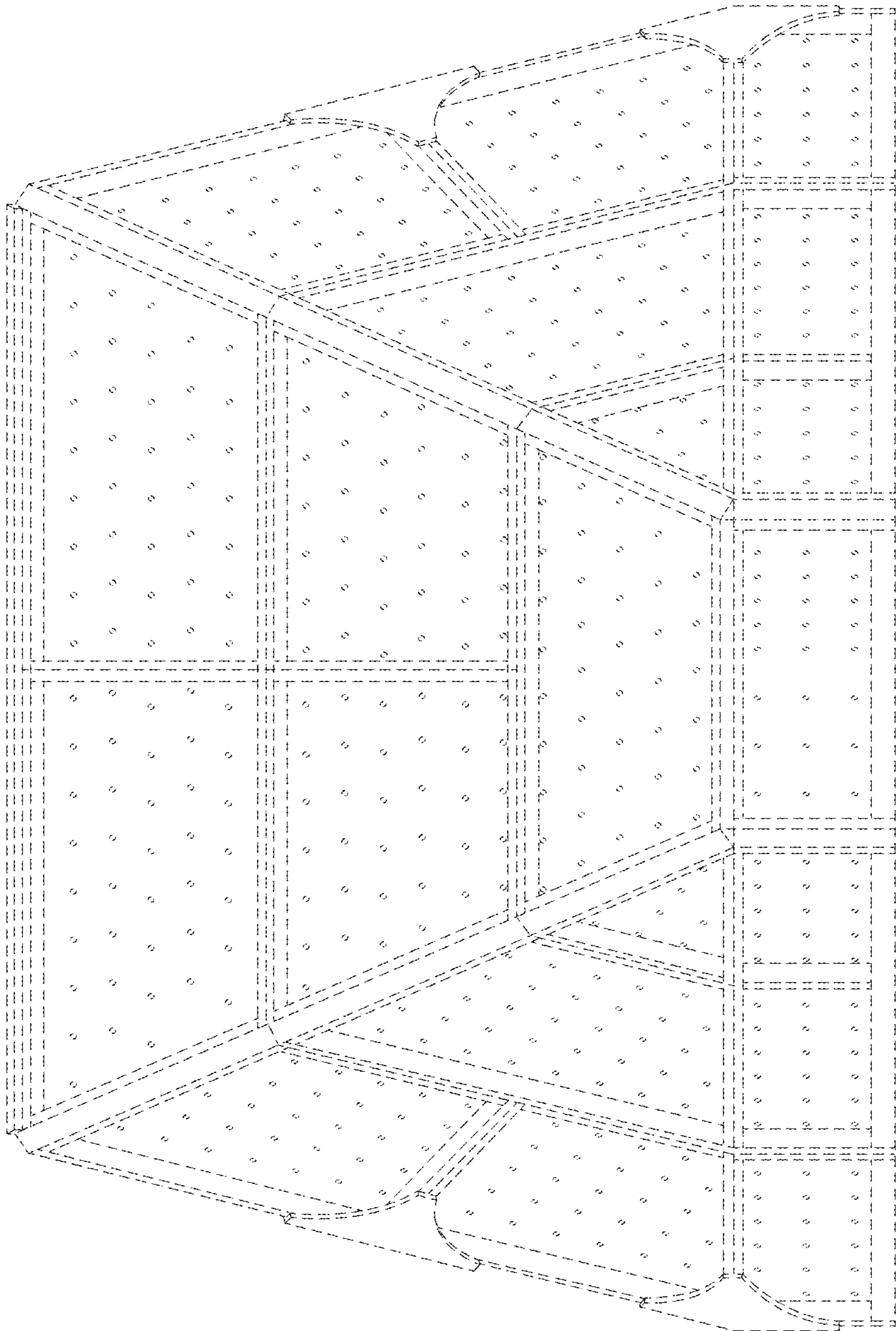

FIG.28

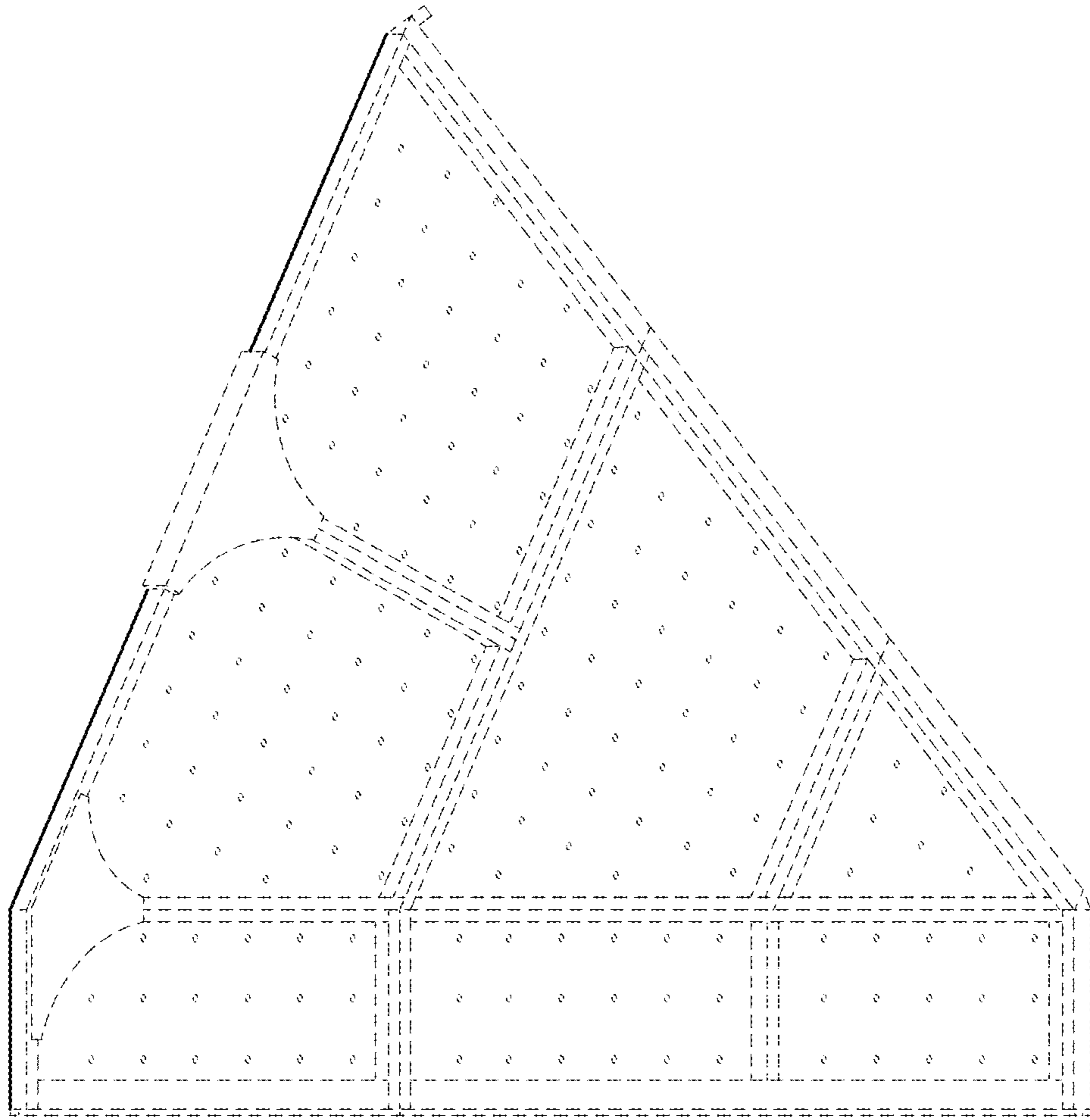

FIG.29

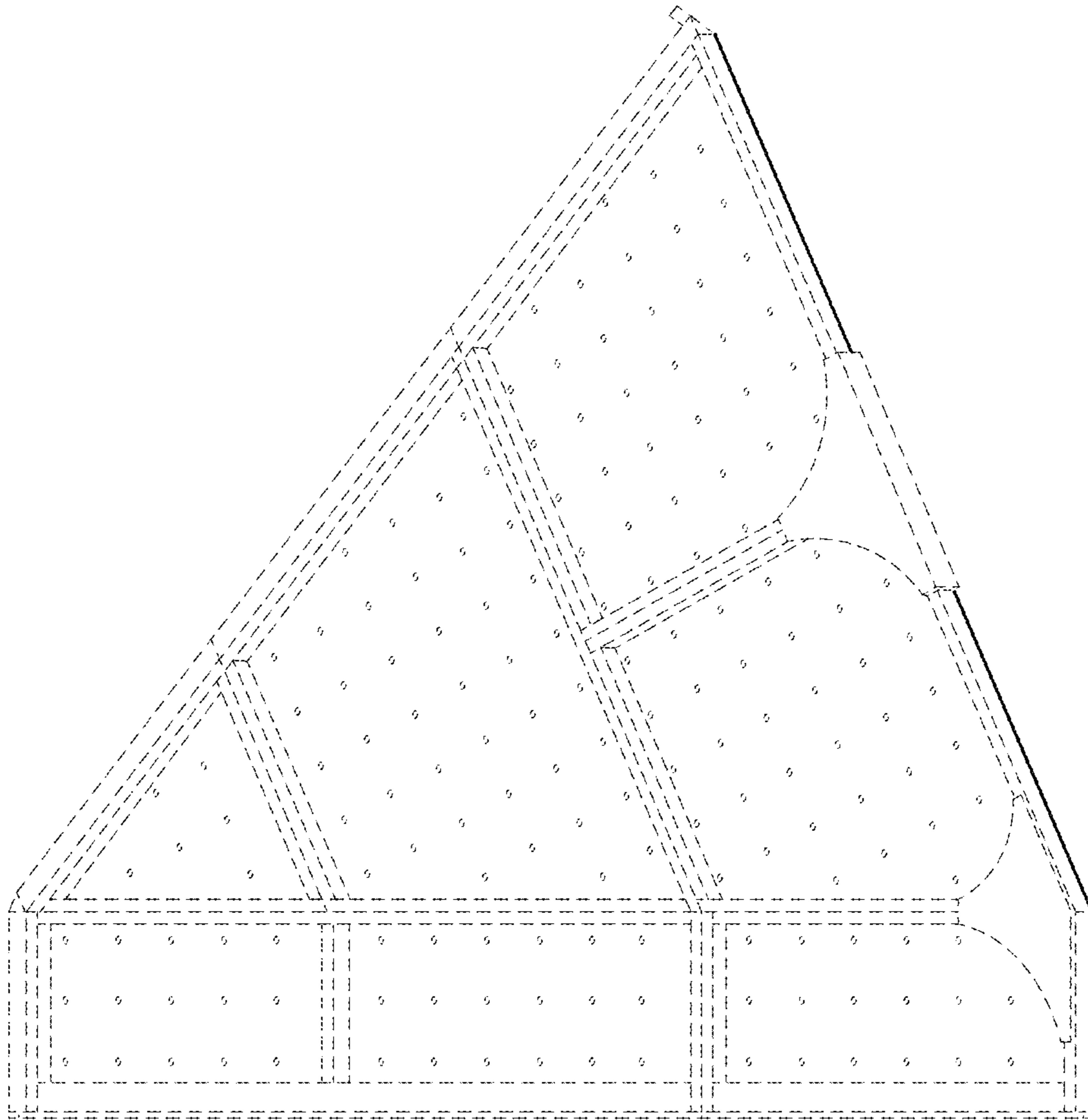

FIG.30

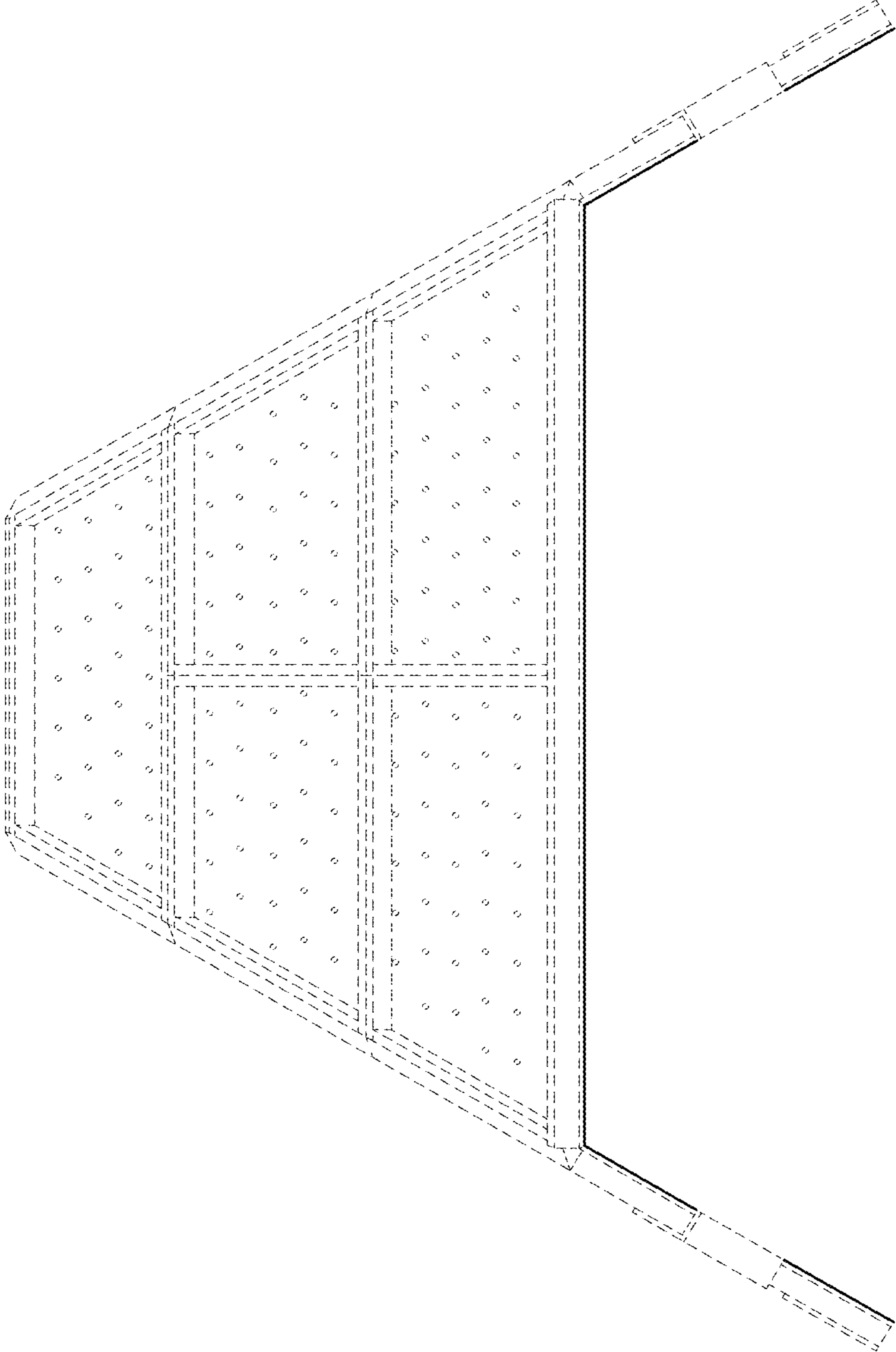

FIG.31

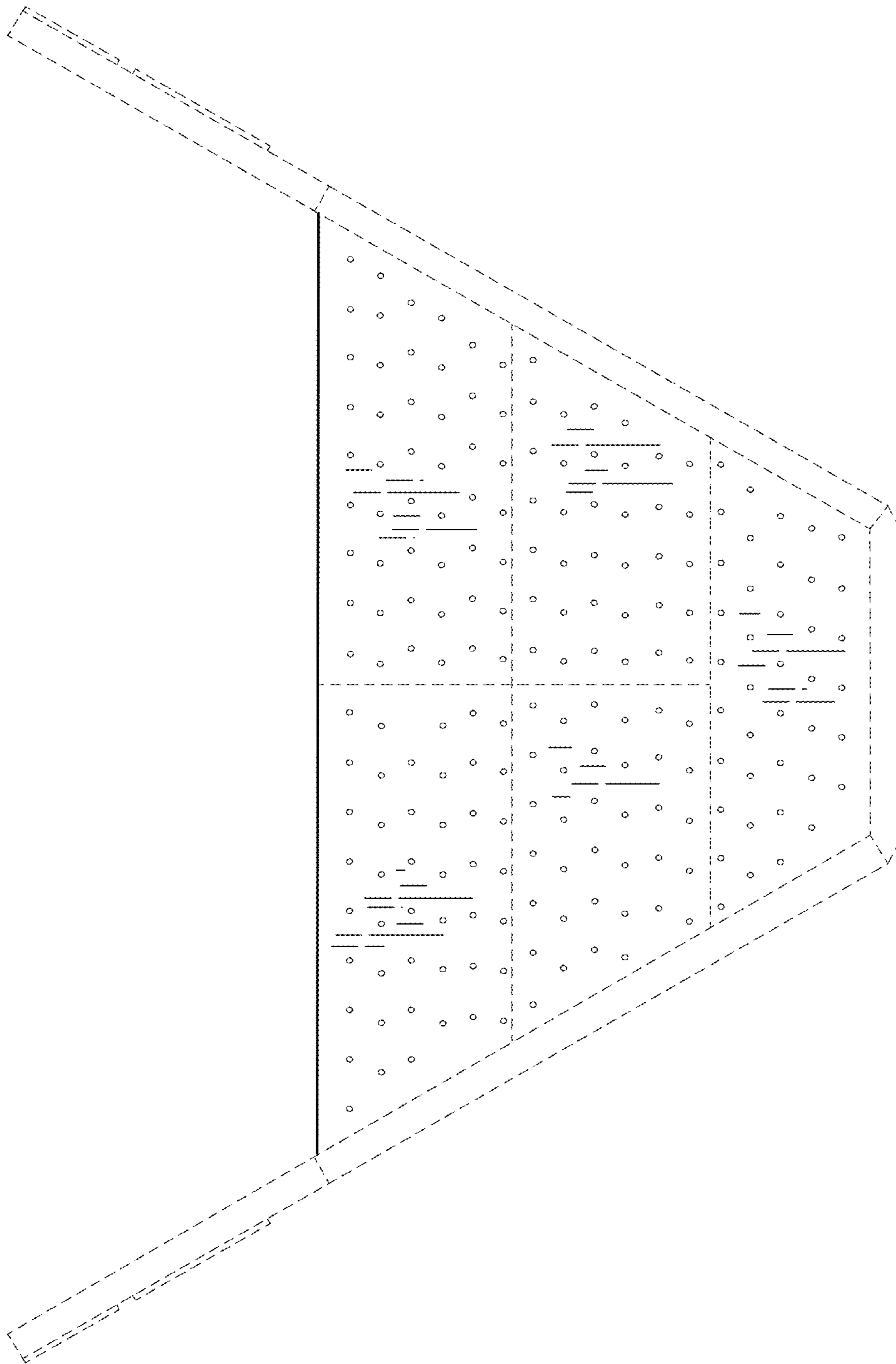

FIG.32

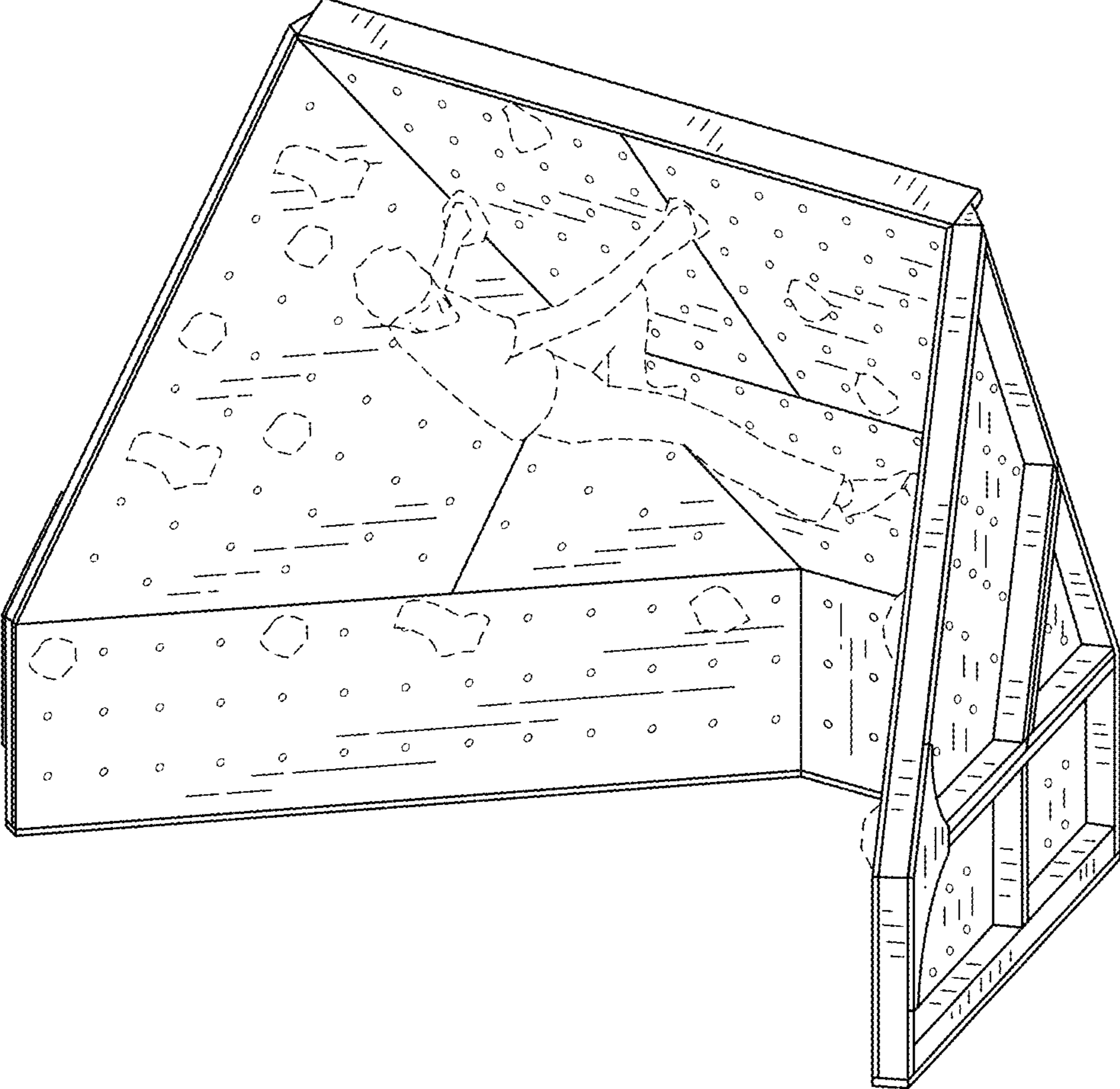

FIG.33

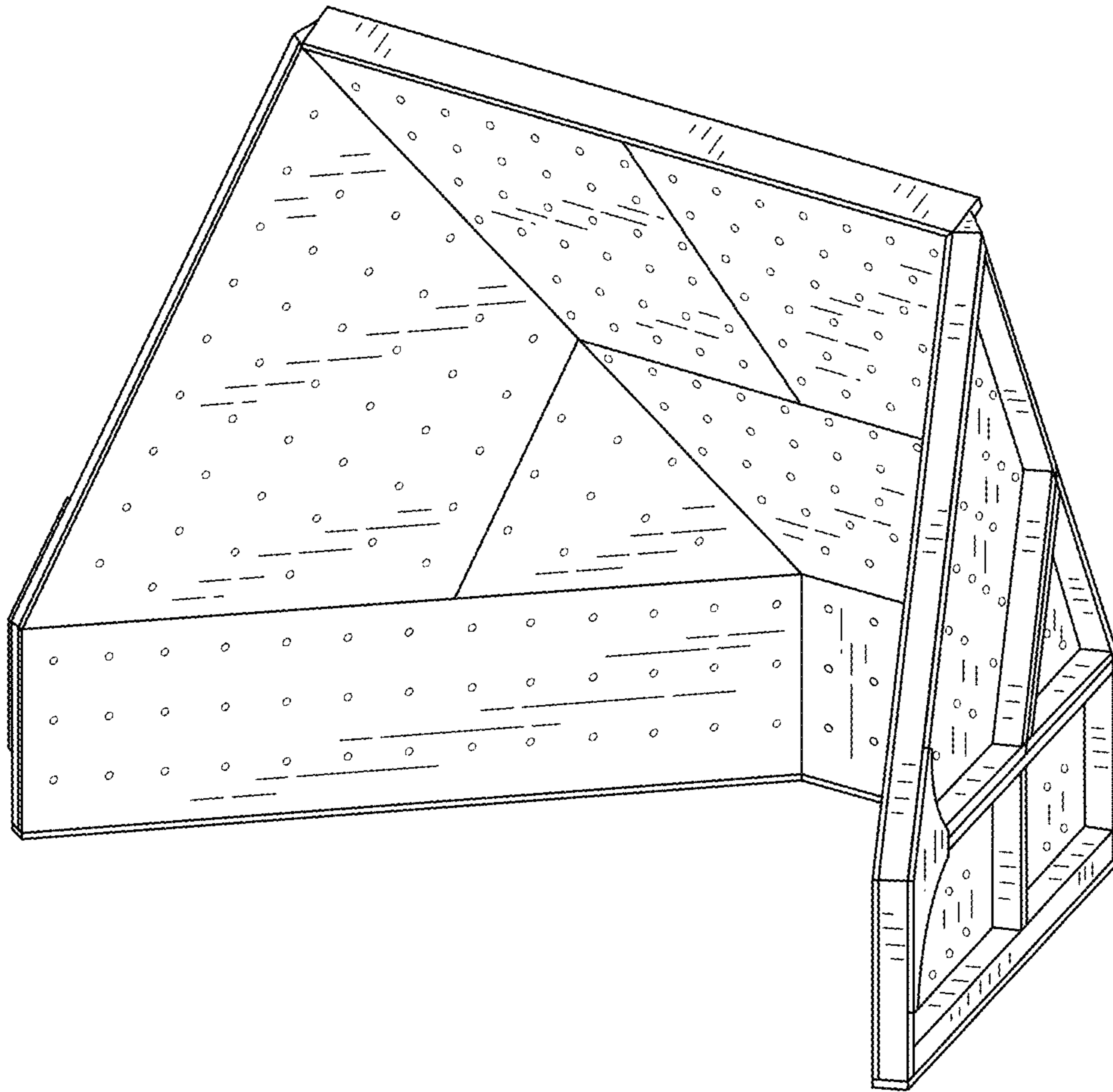

FIG.34

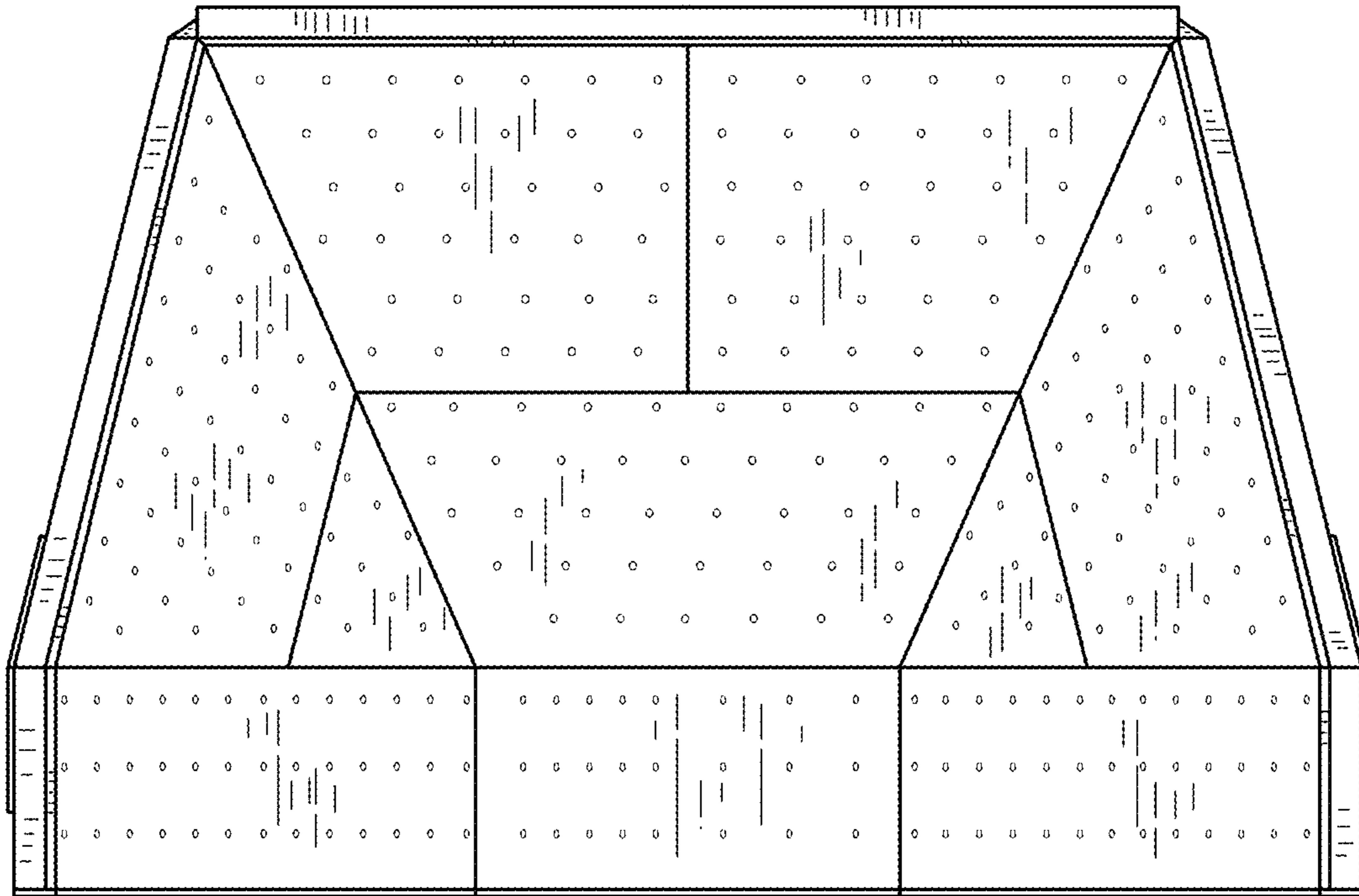

FIG.35

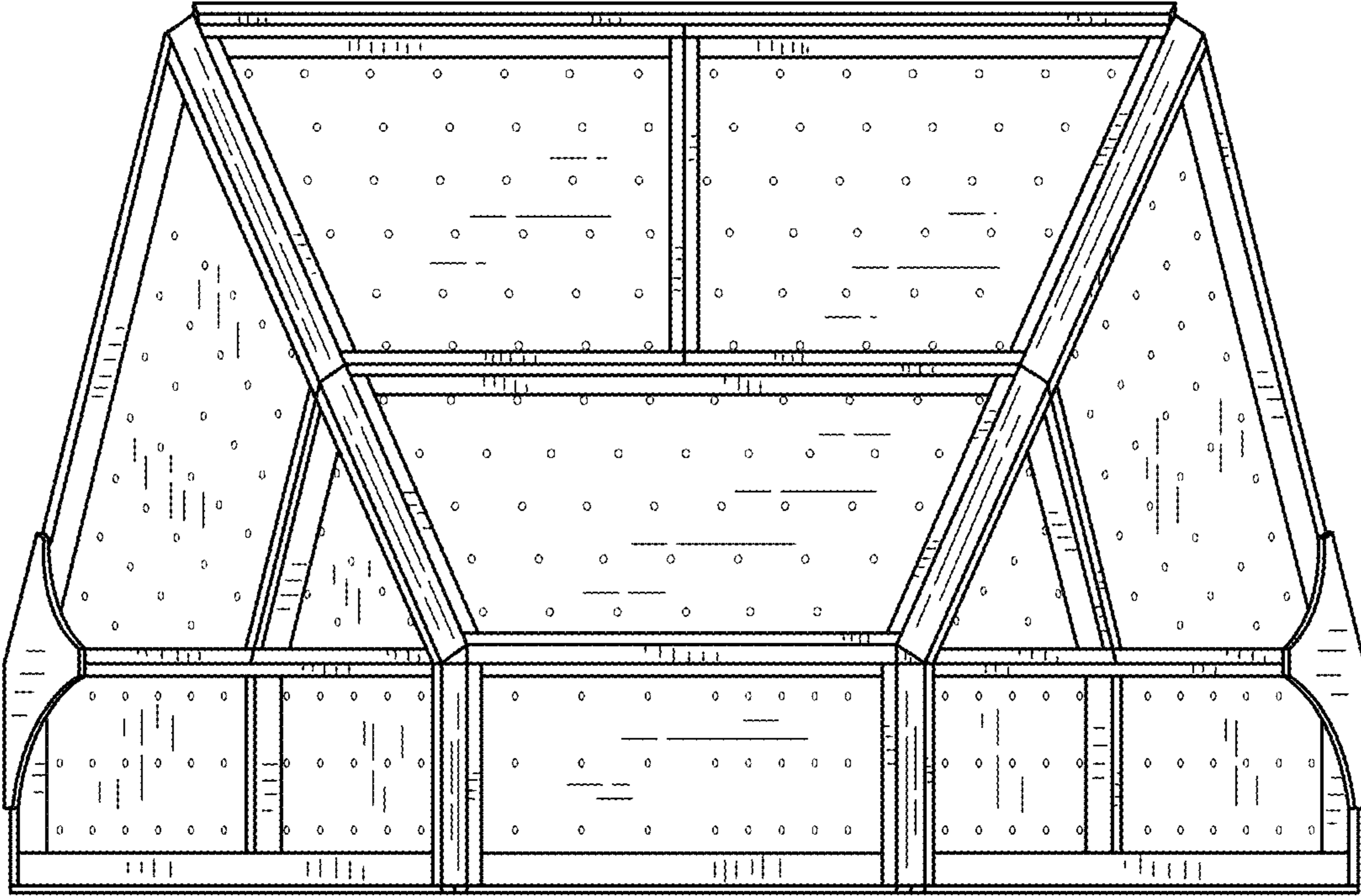

FIG.36

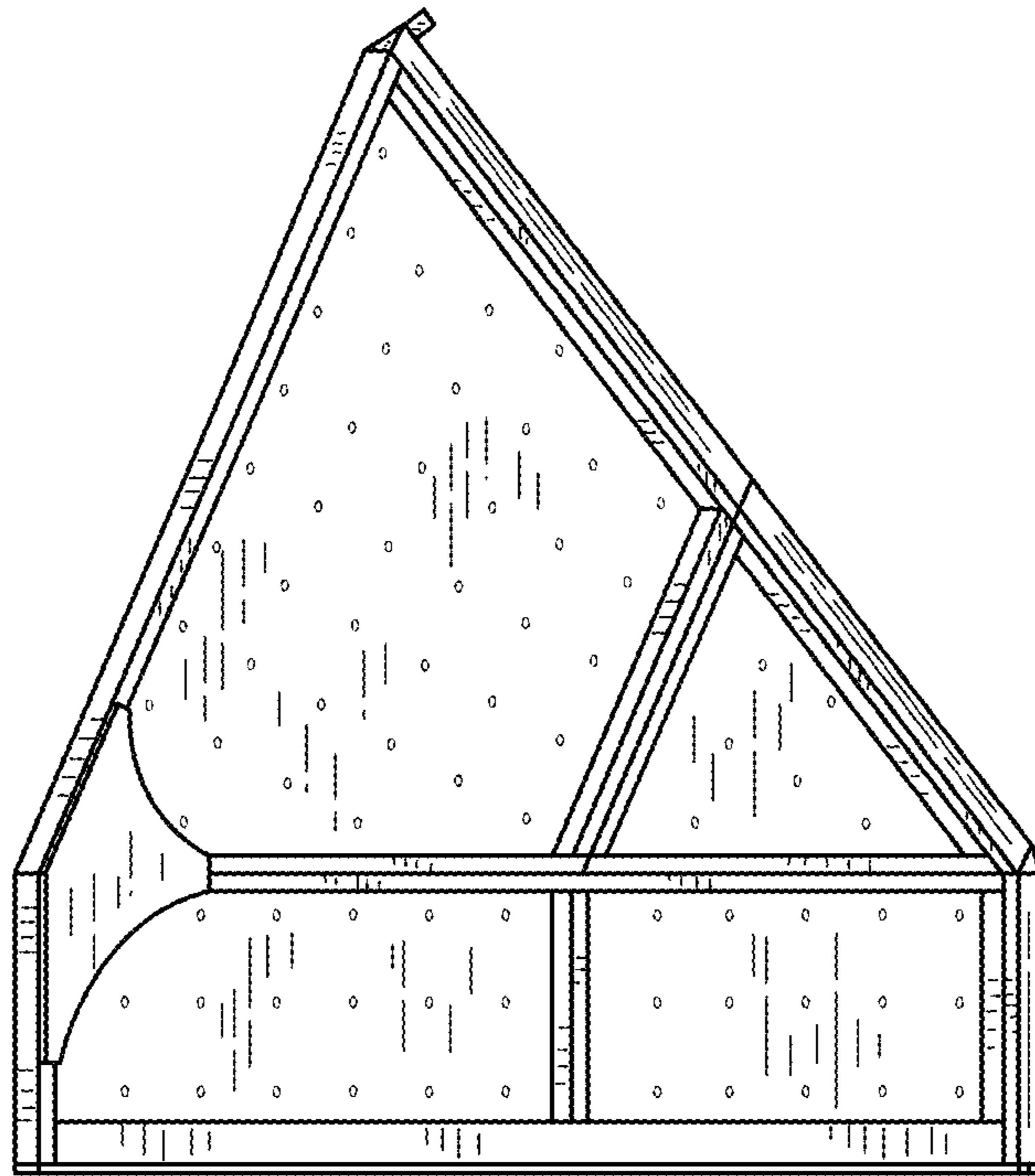

FIG.37

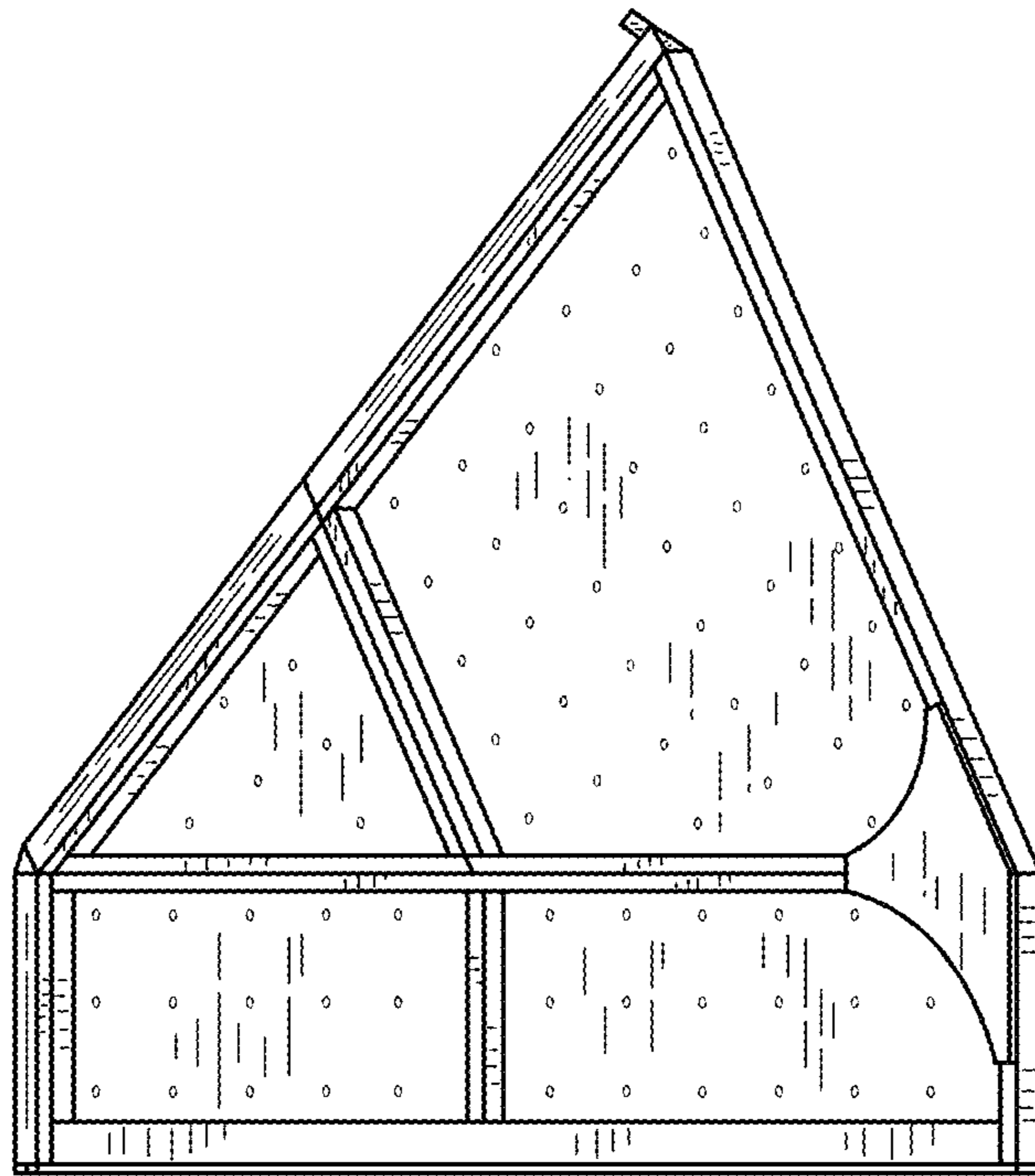

FIG.38

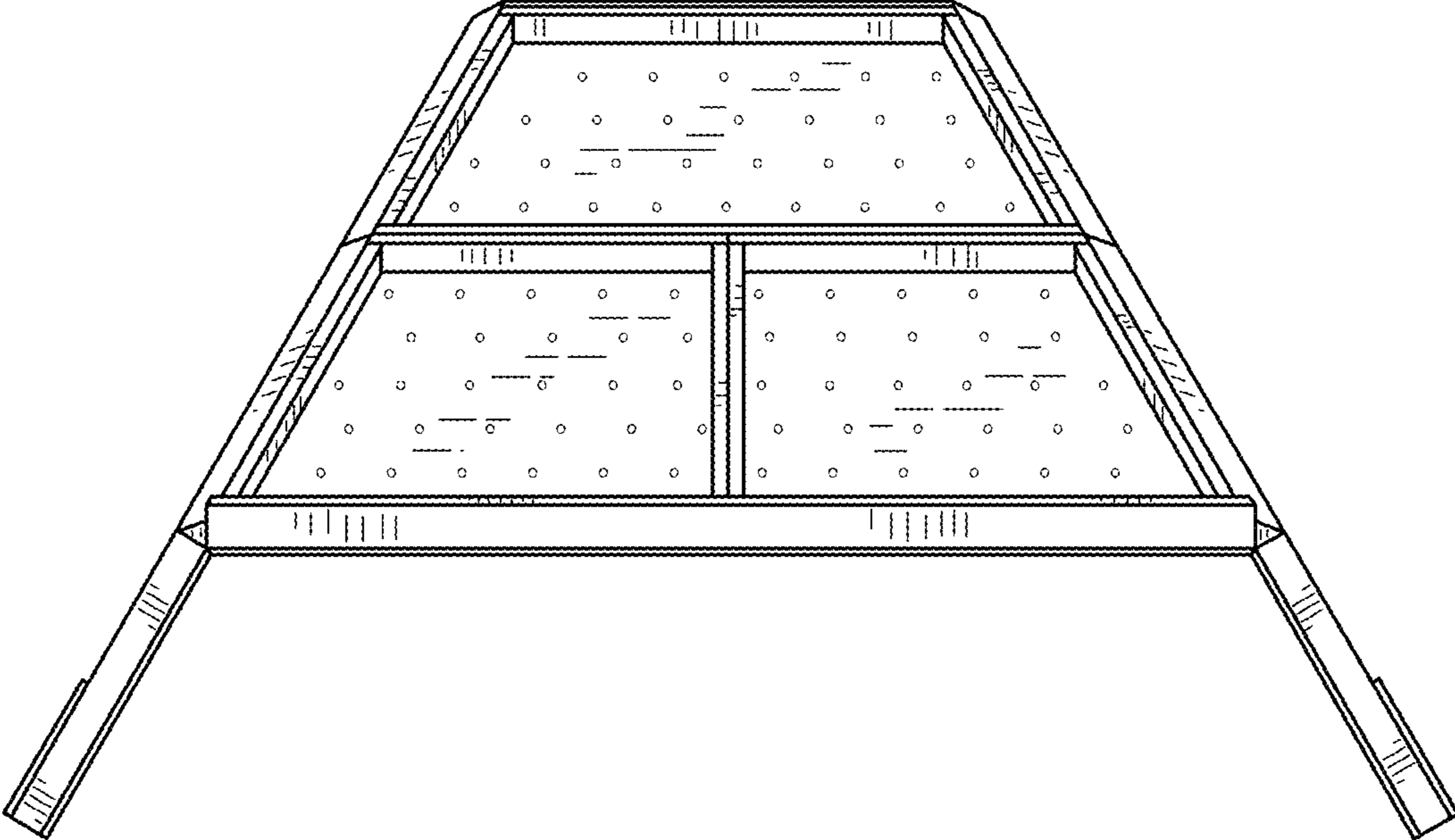

FIG.39

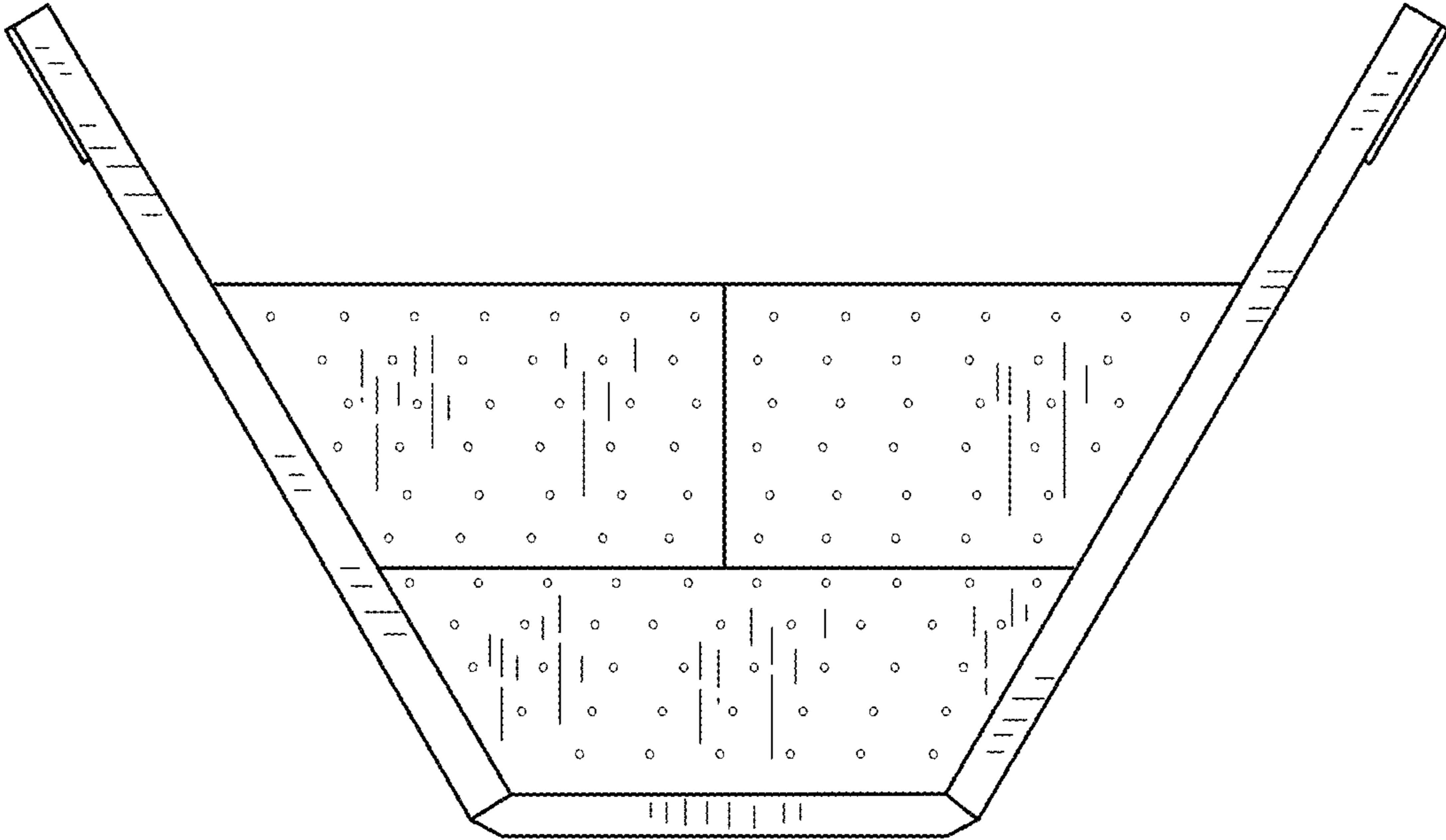

FIG.40

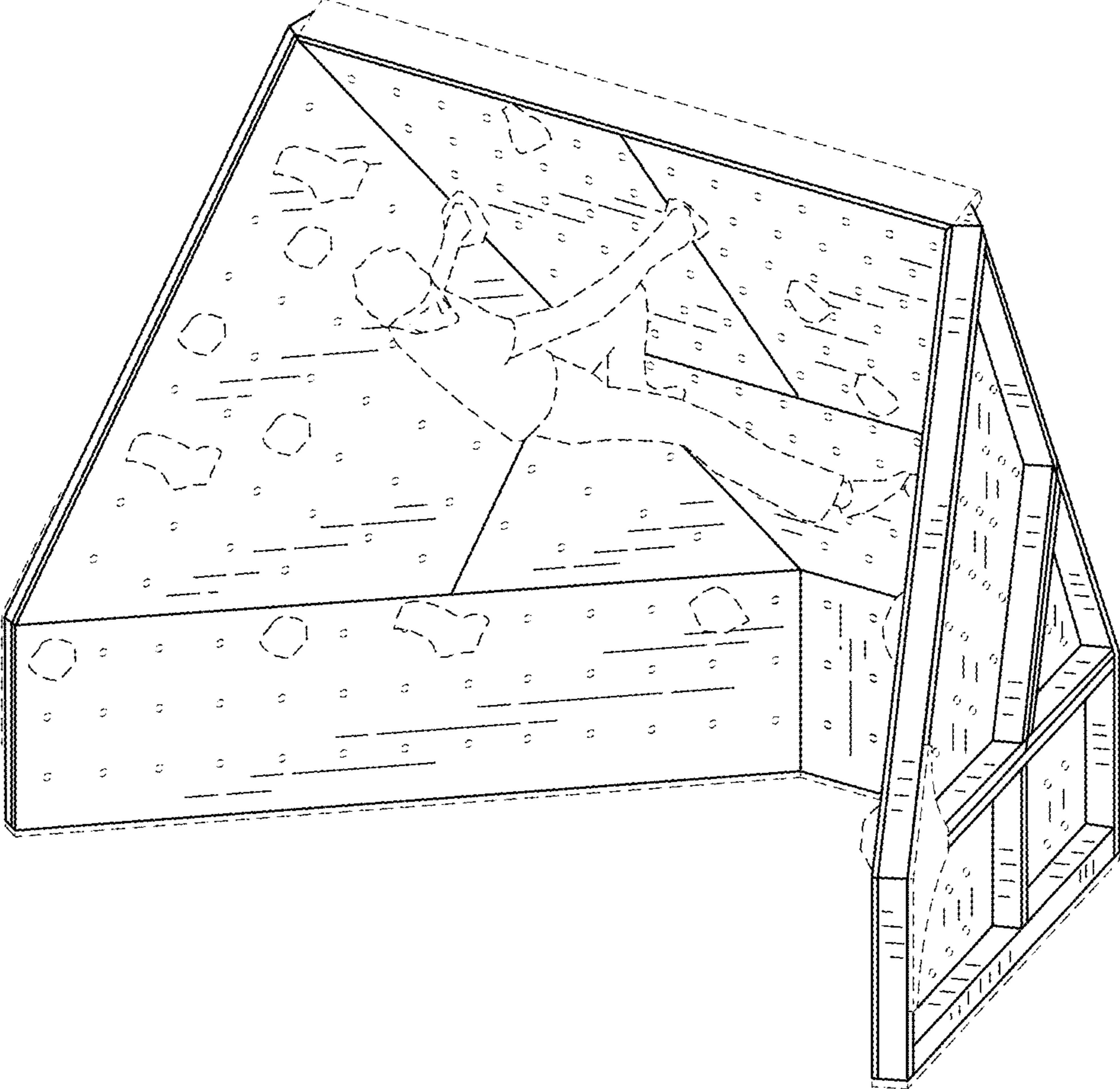

FIG.41

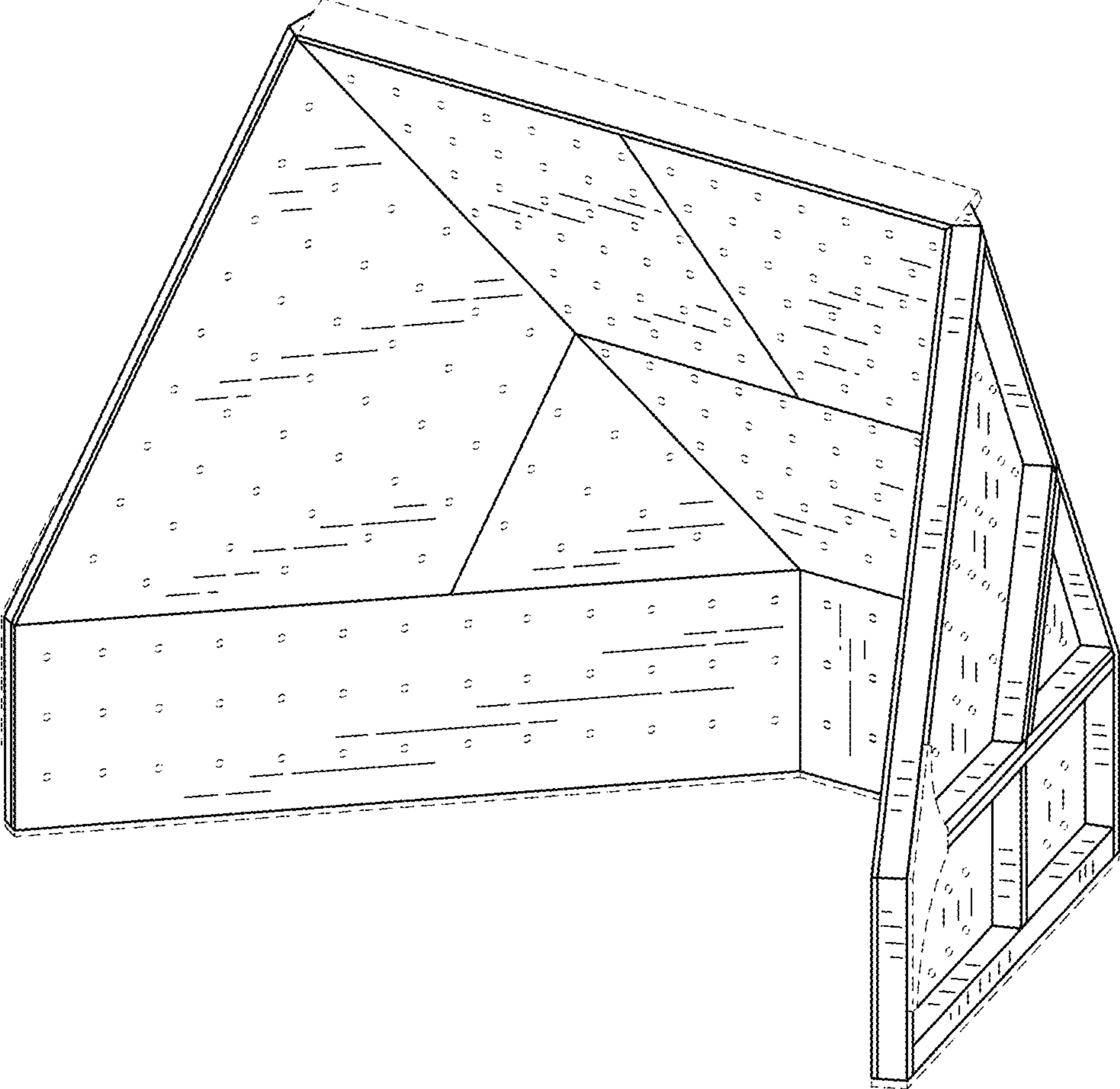

FIG.42

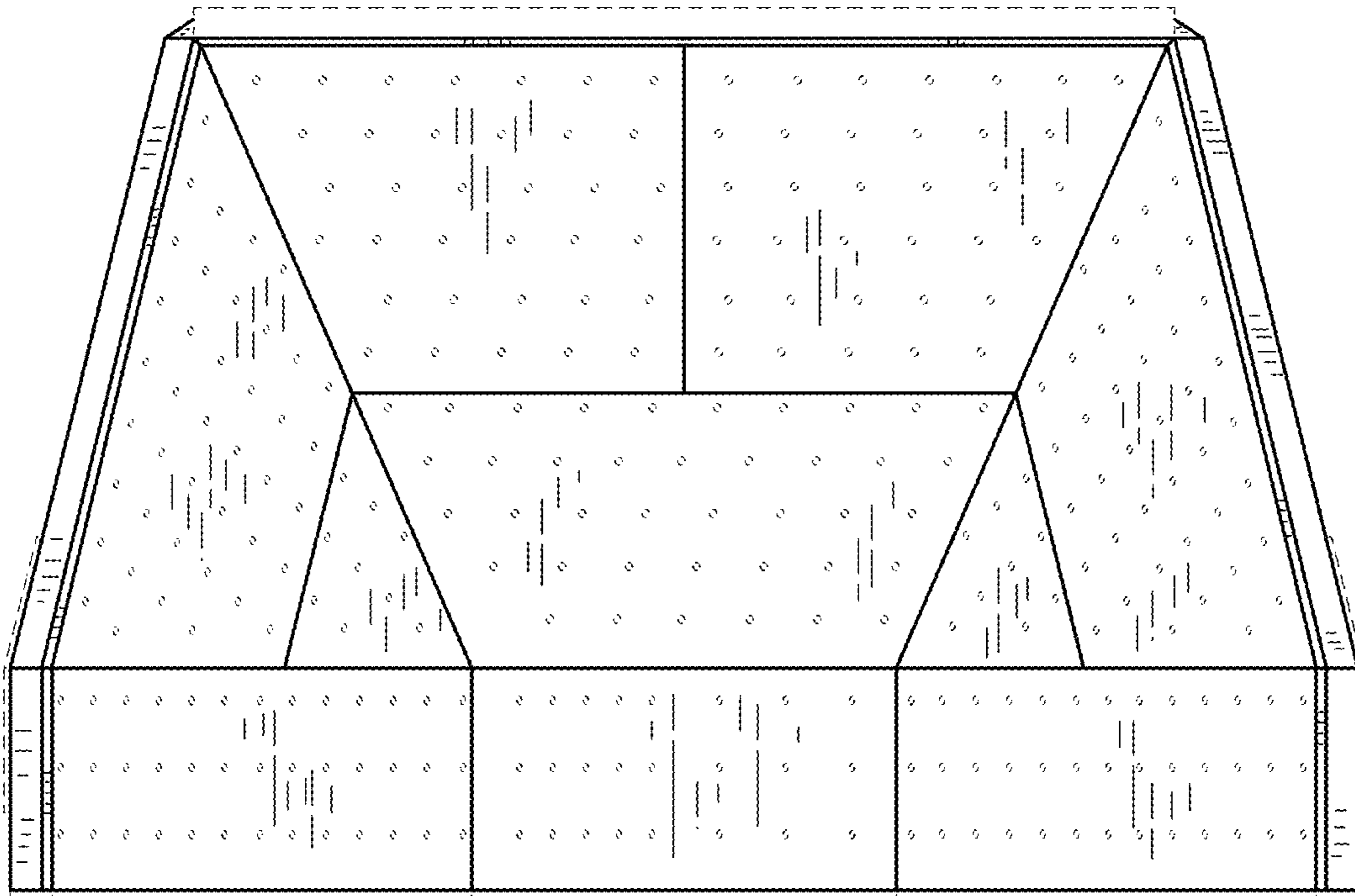

FIG.43

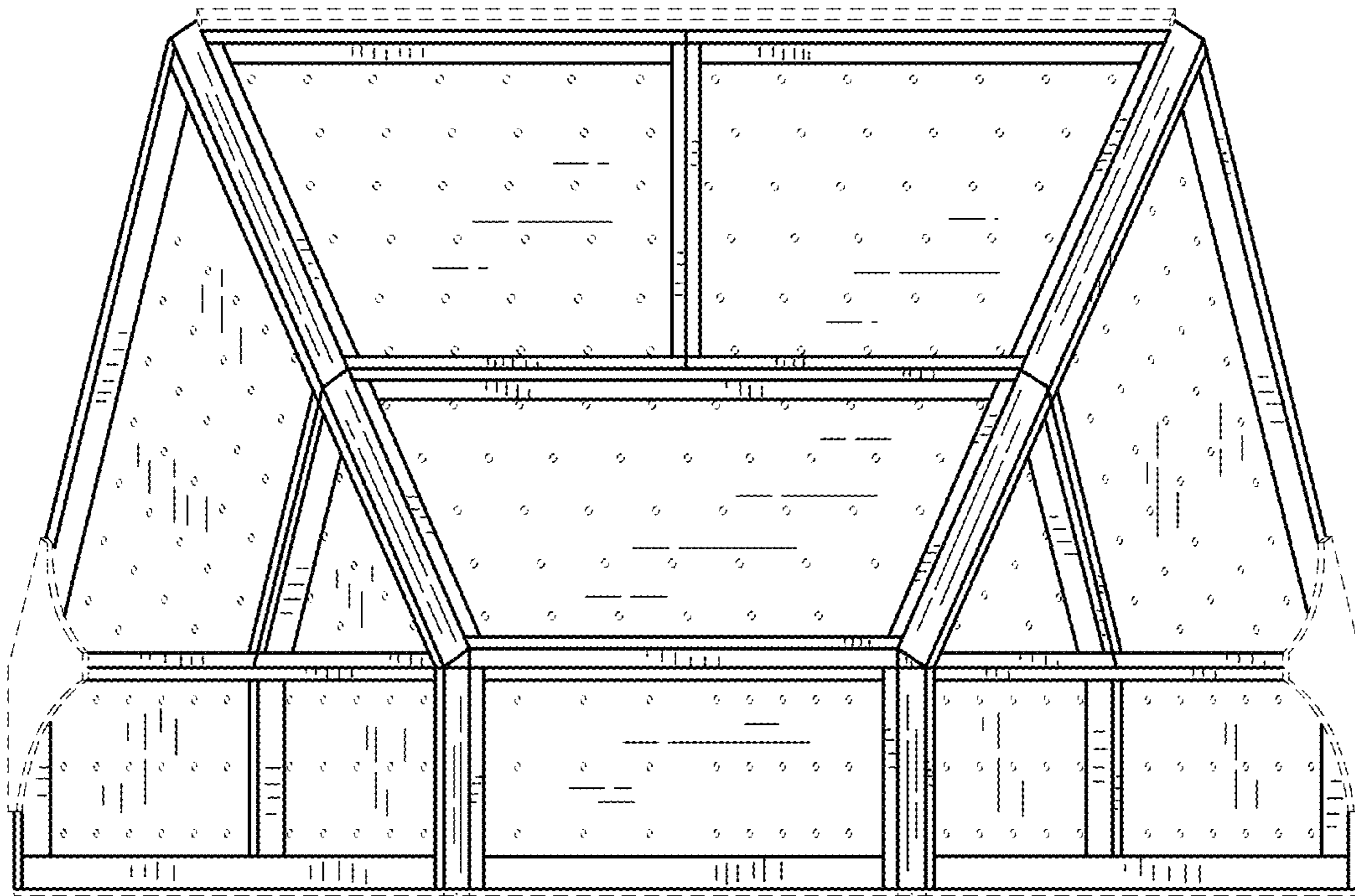

FIG.44

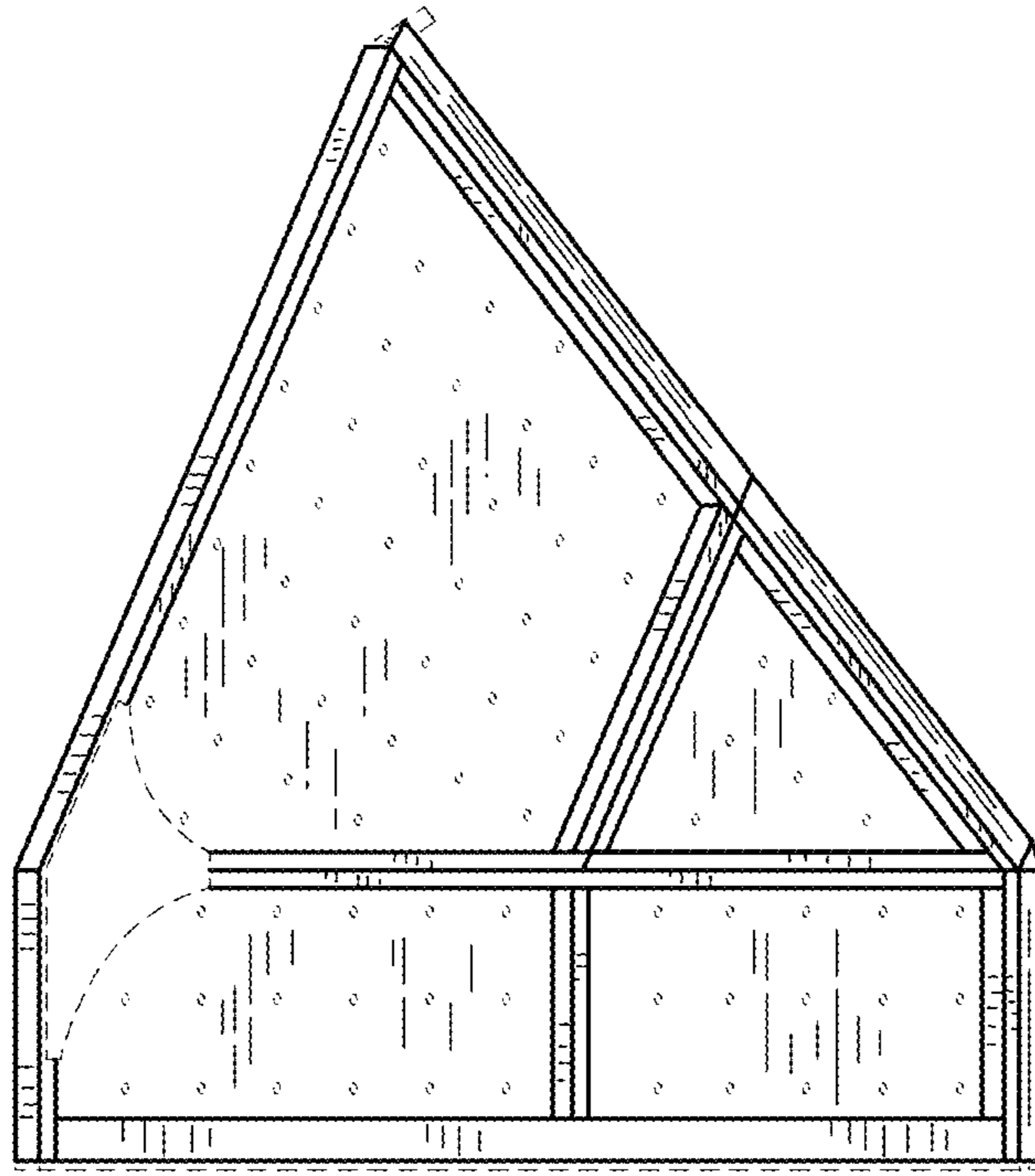

FIG.45

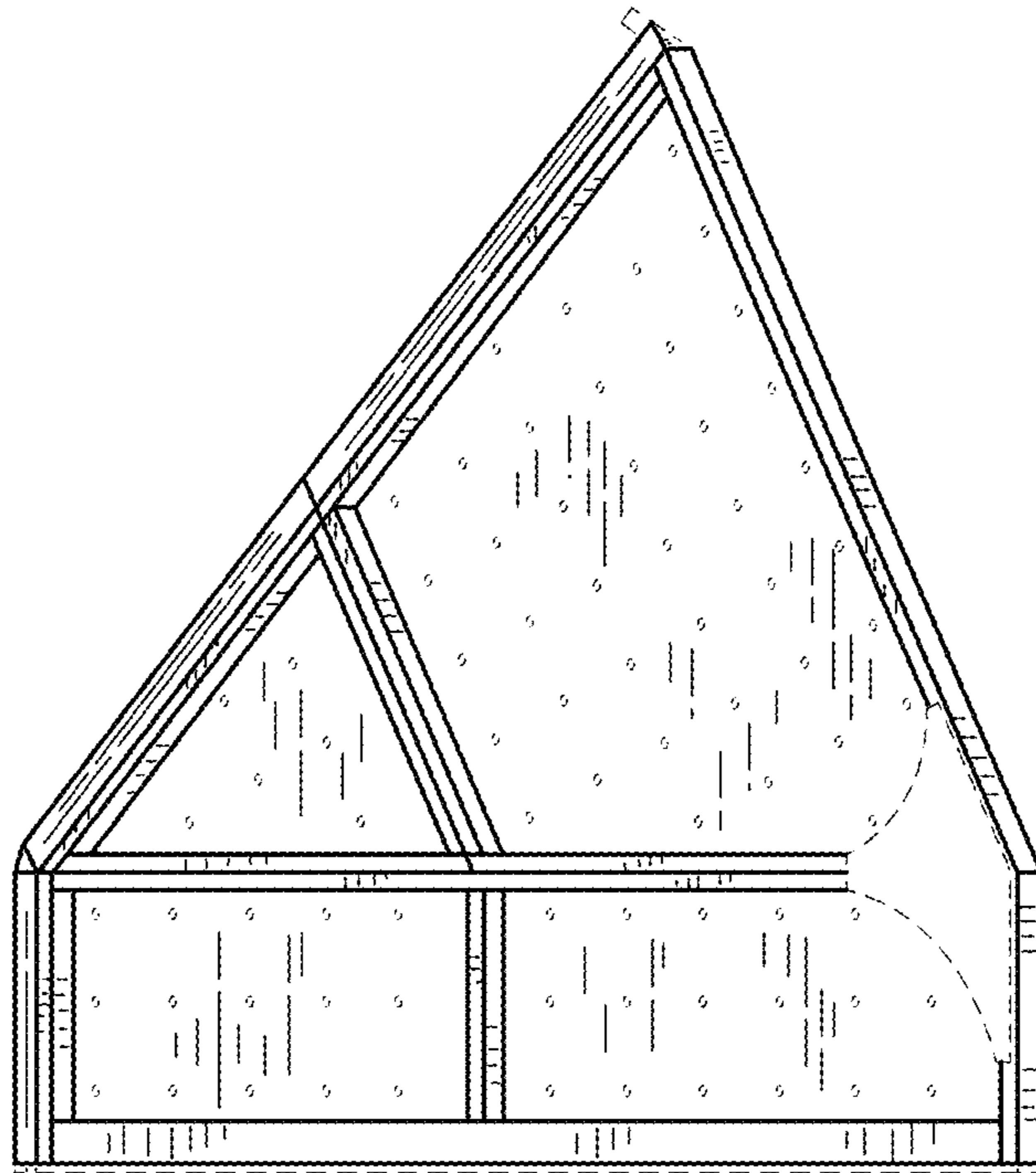

FIG.46

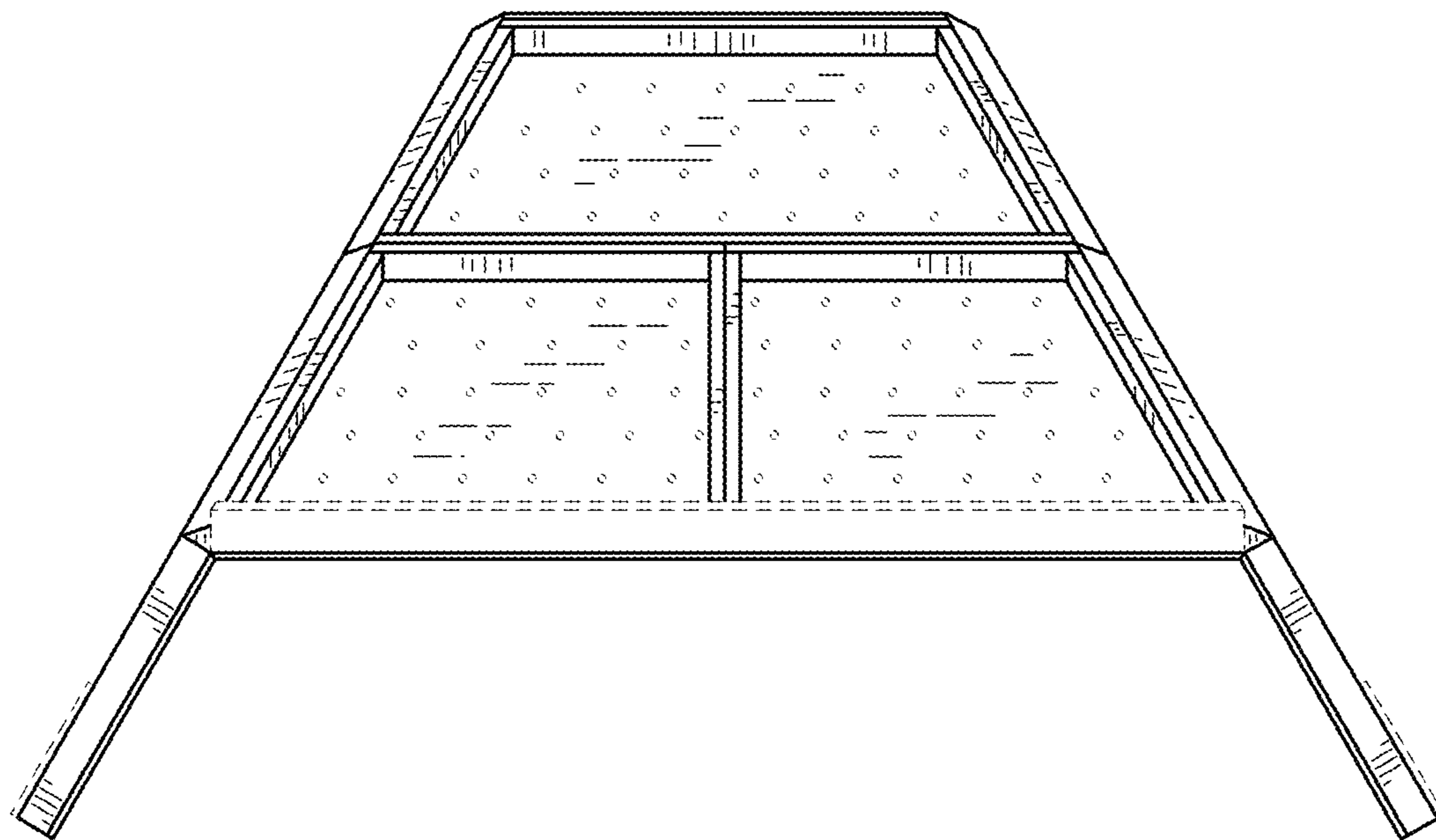

FIG.47

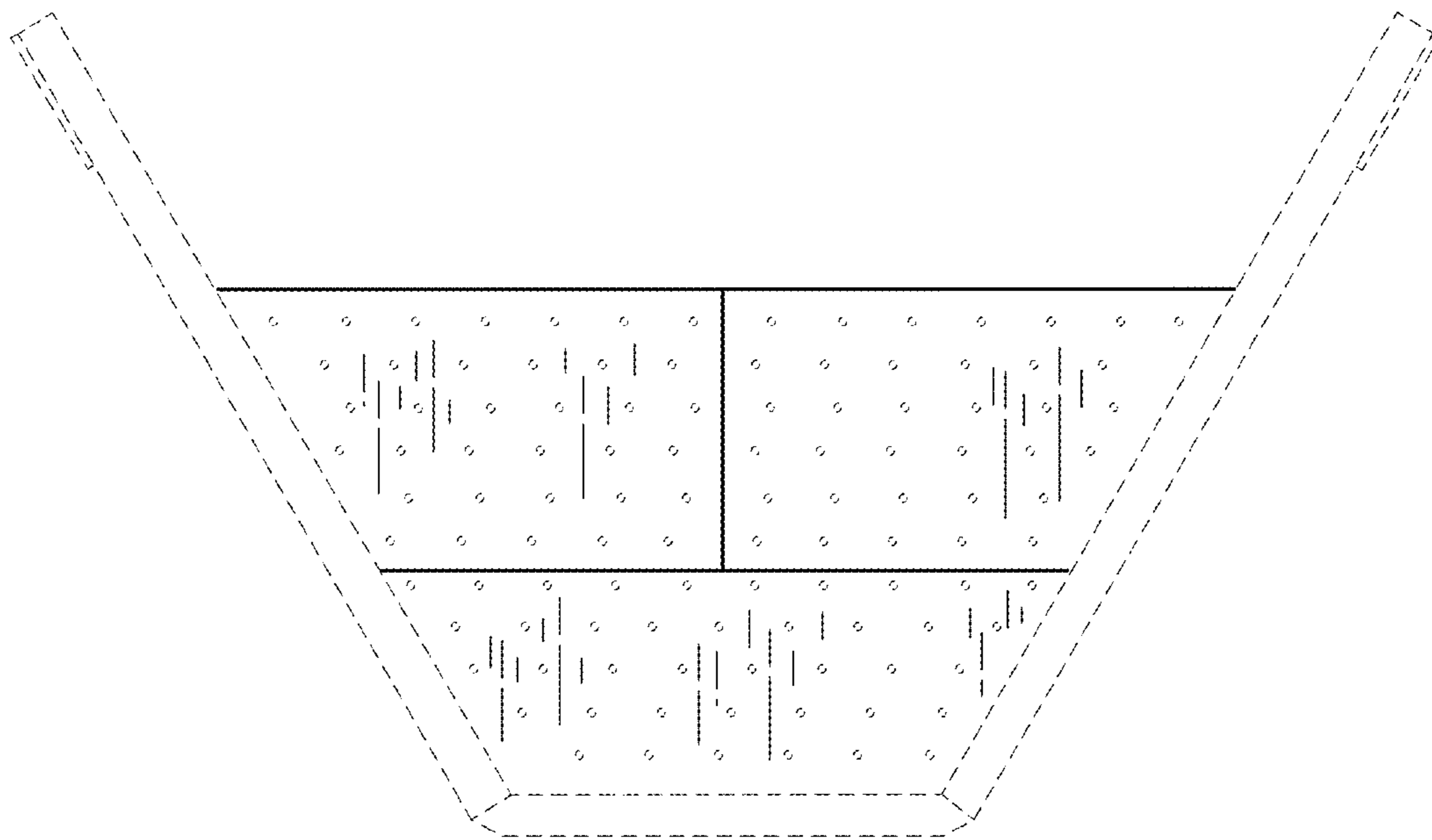

FIG.48

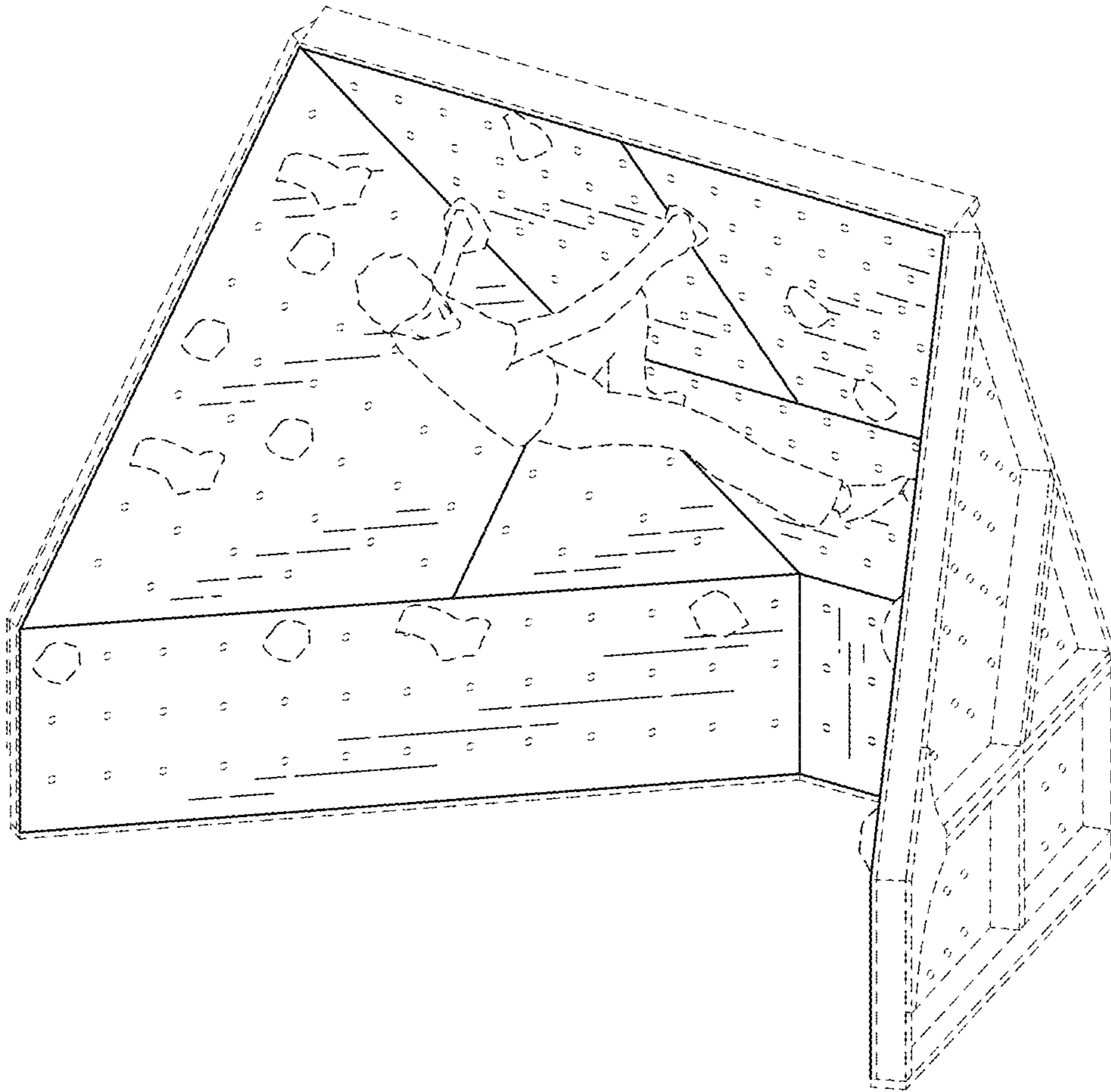

FIG.49

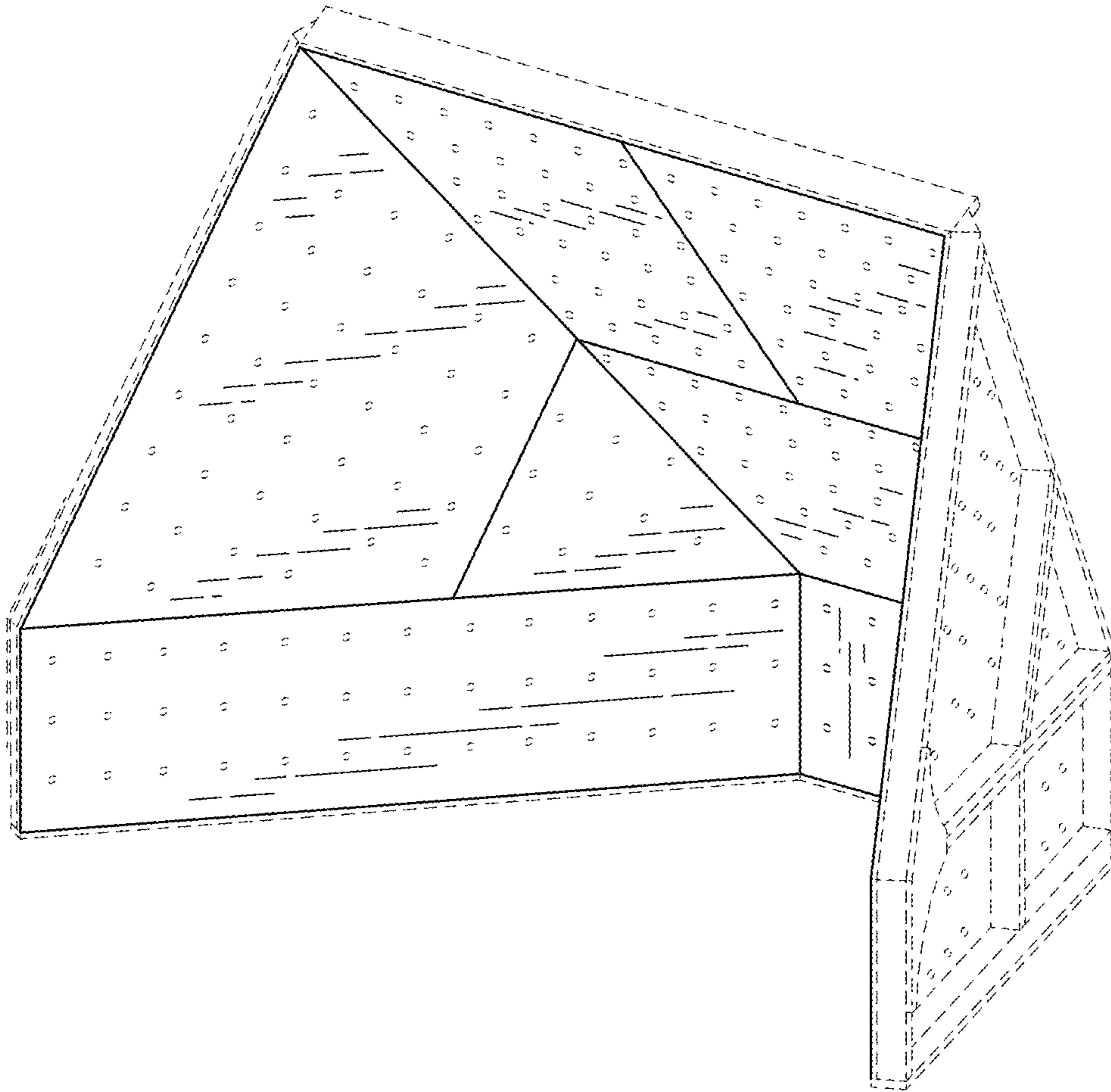

FIG.50

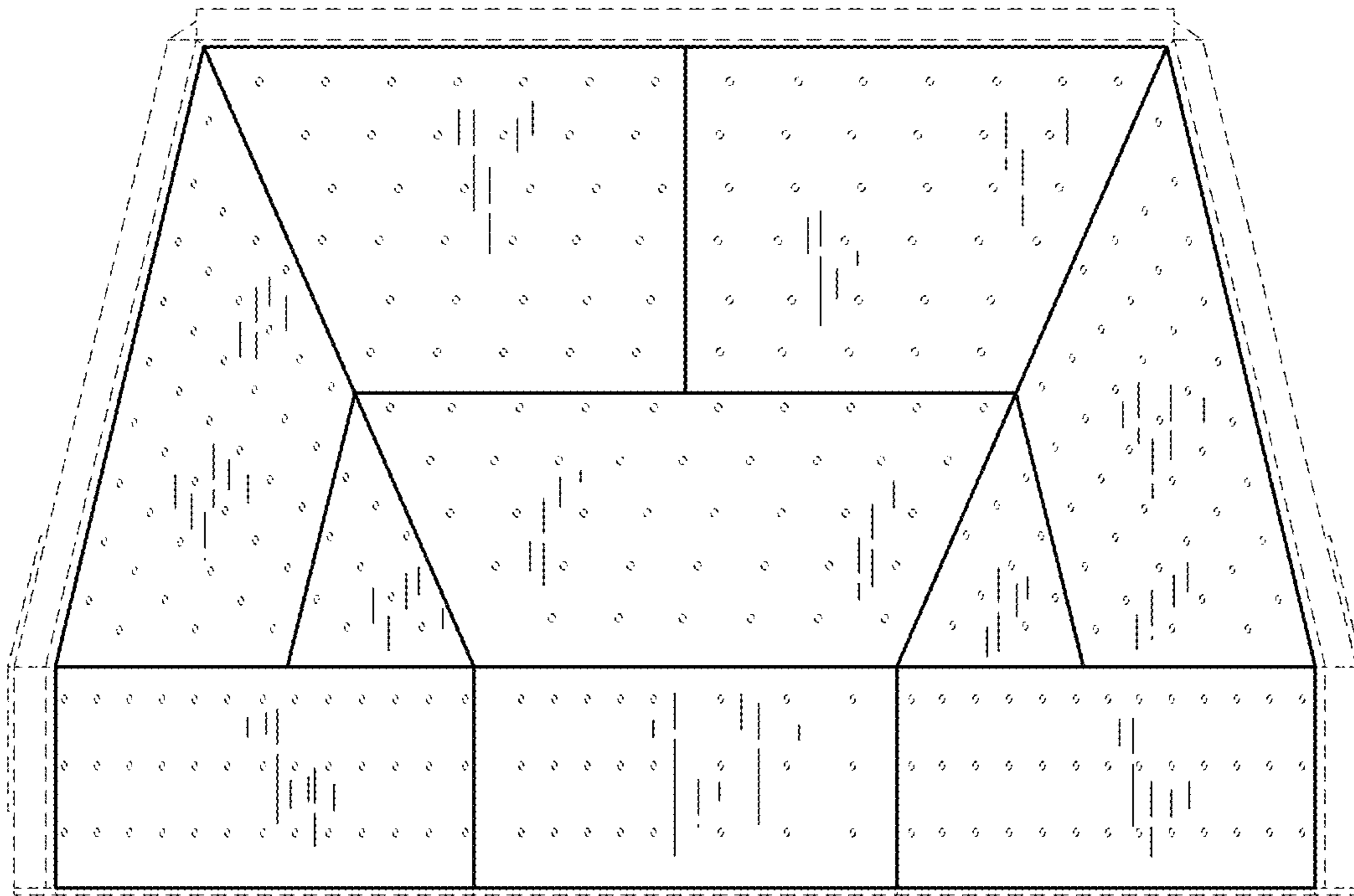

FIG.51

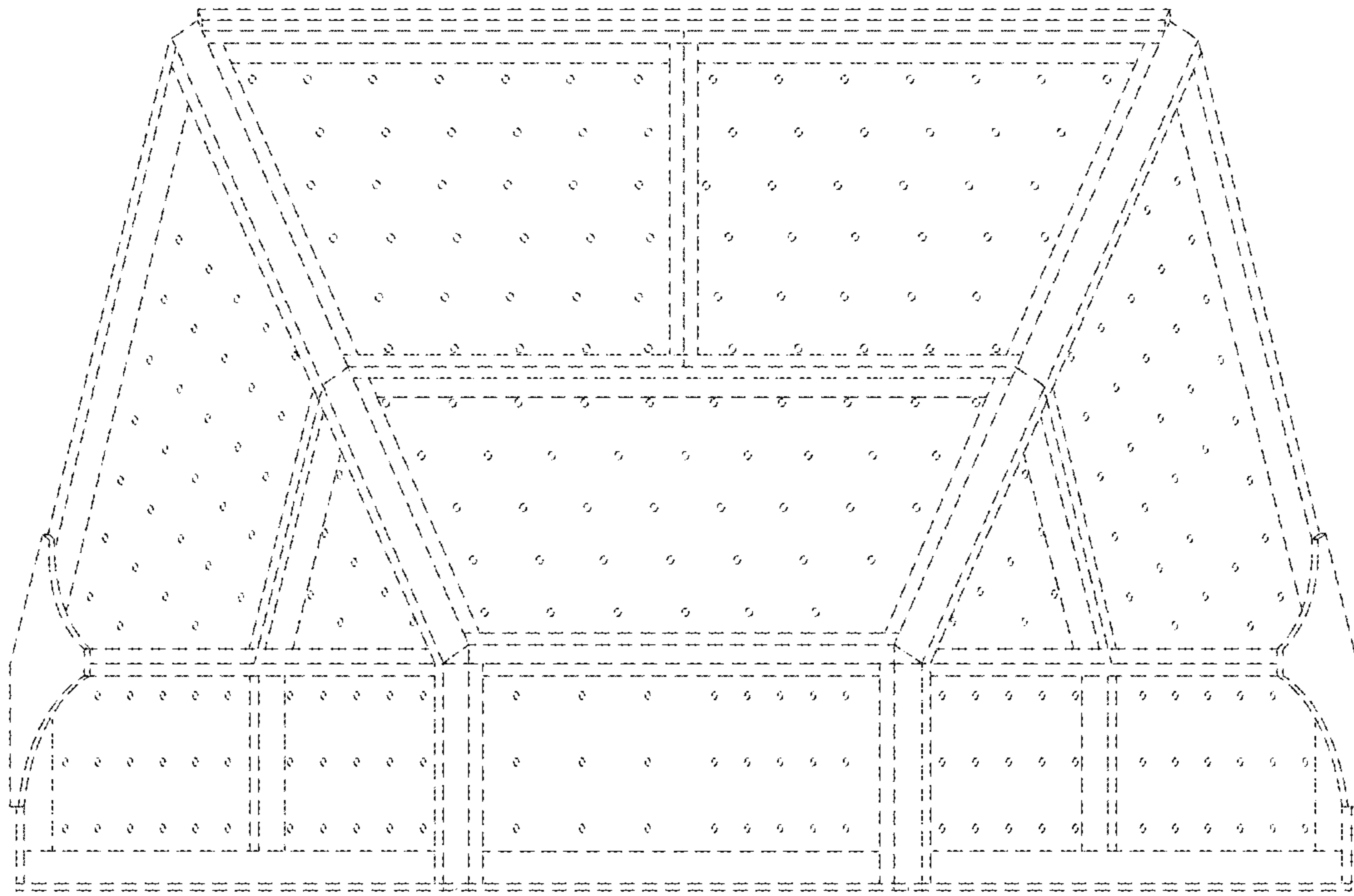

FIG.52

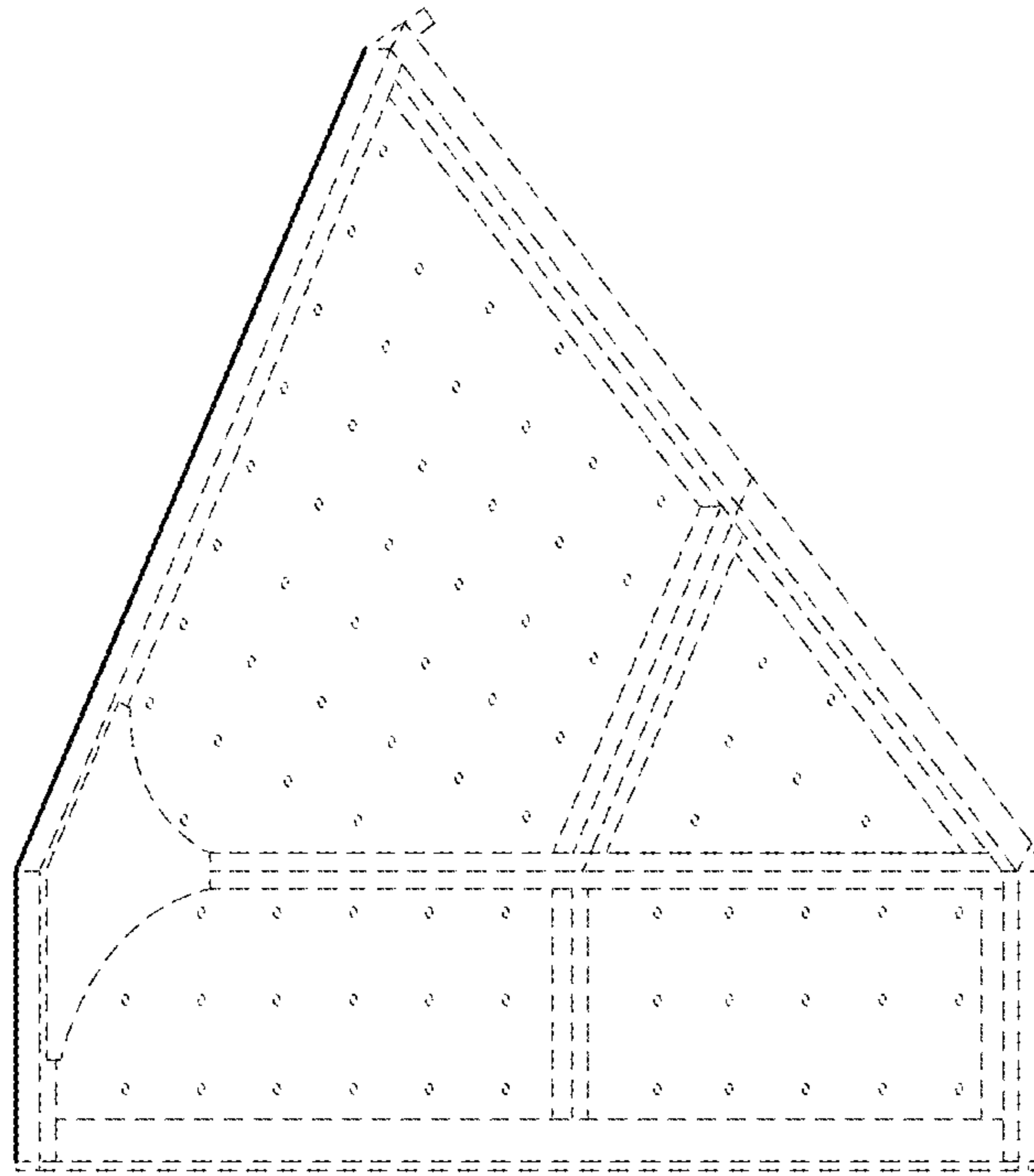

FIG.53

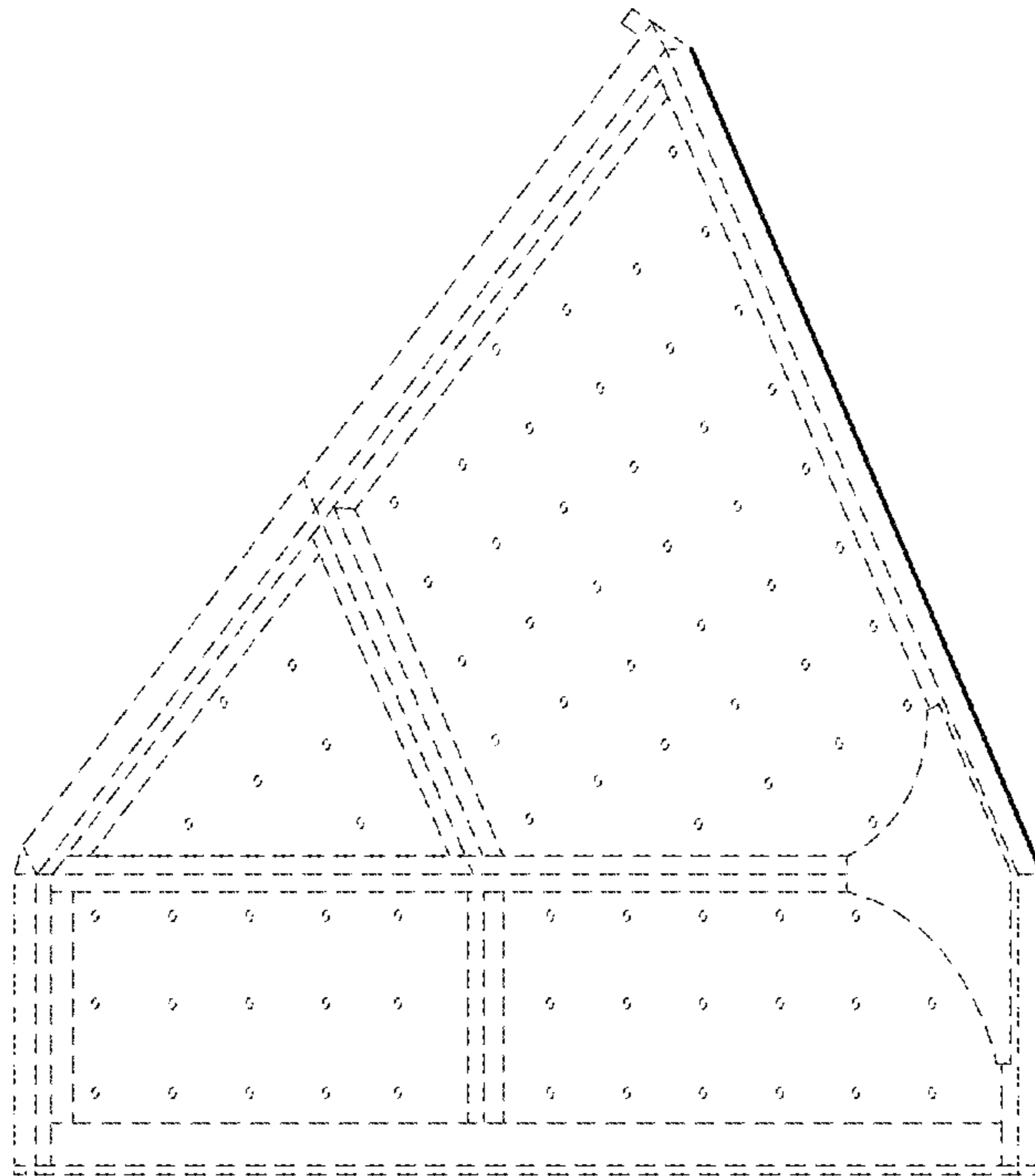

FIG.54

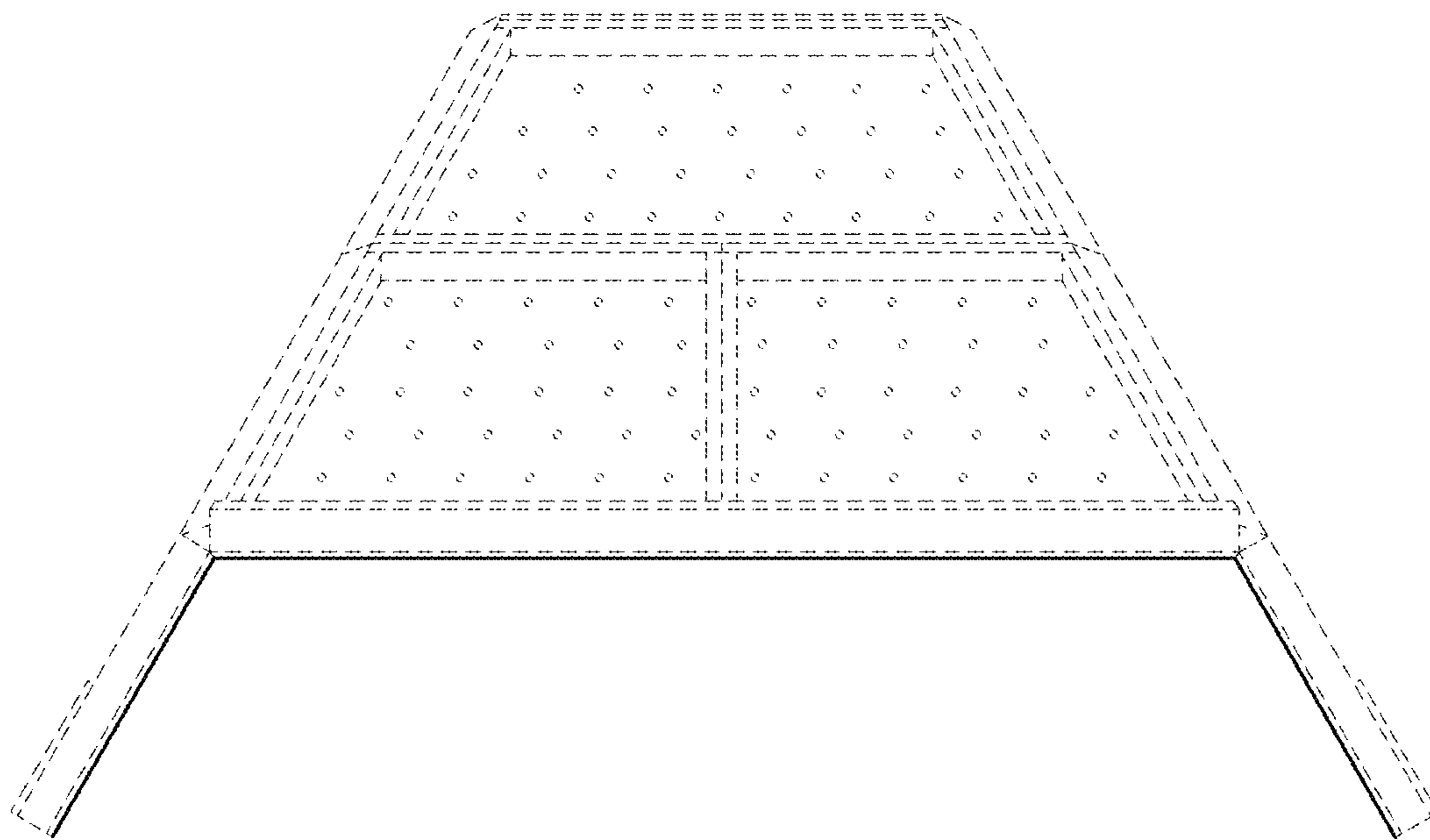

FIG.55

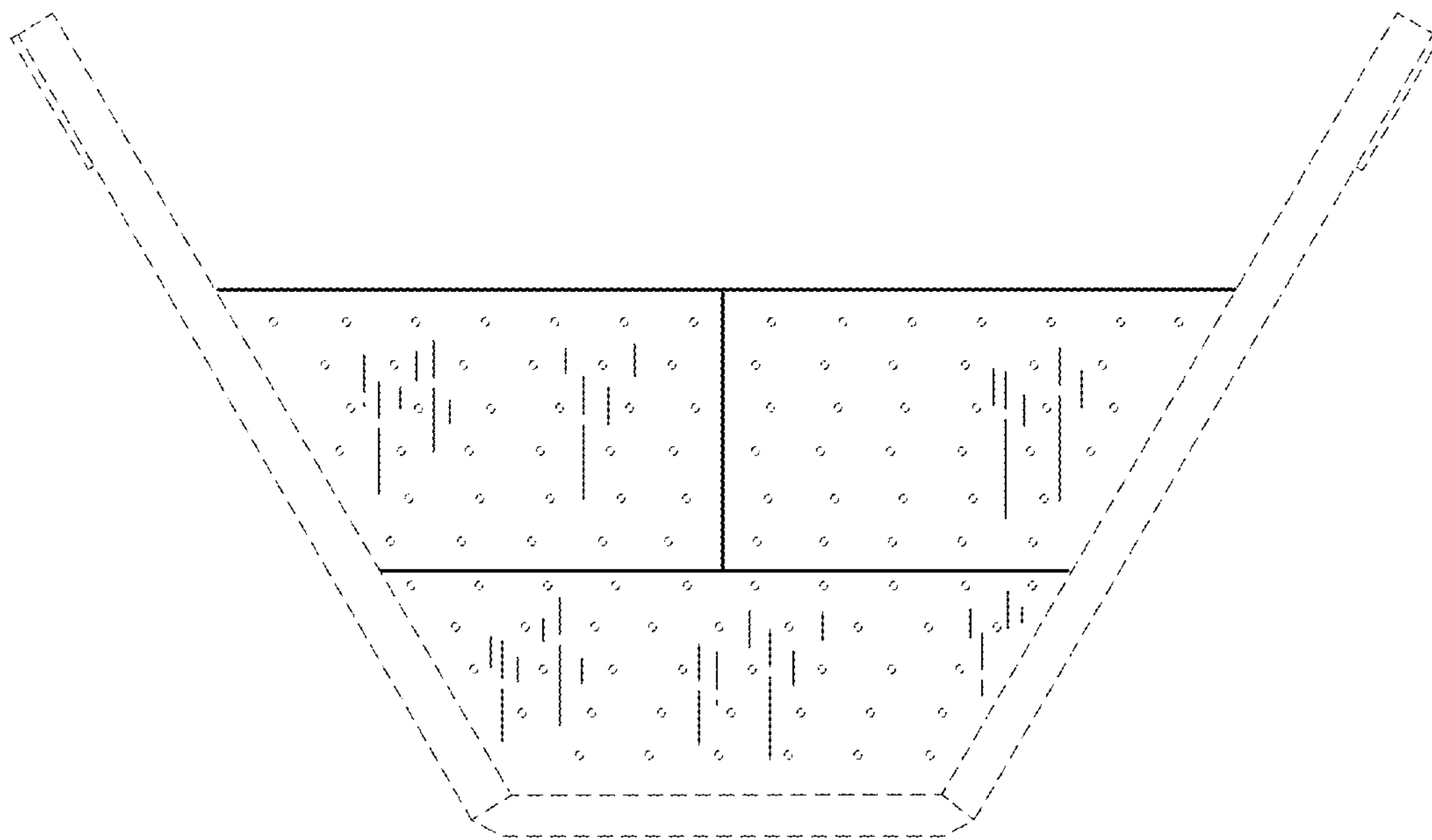

FIG. 56

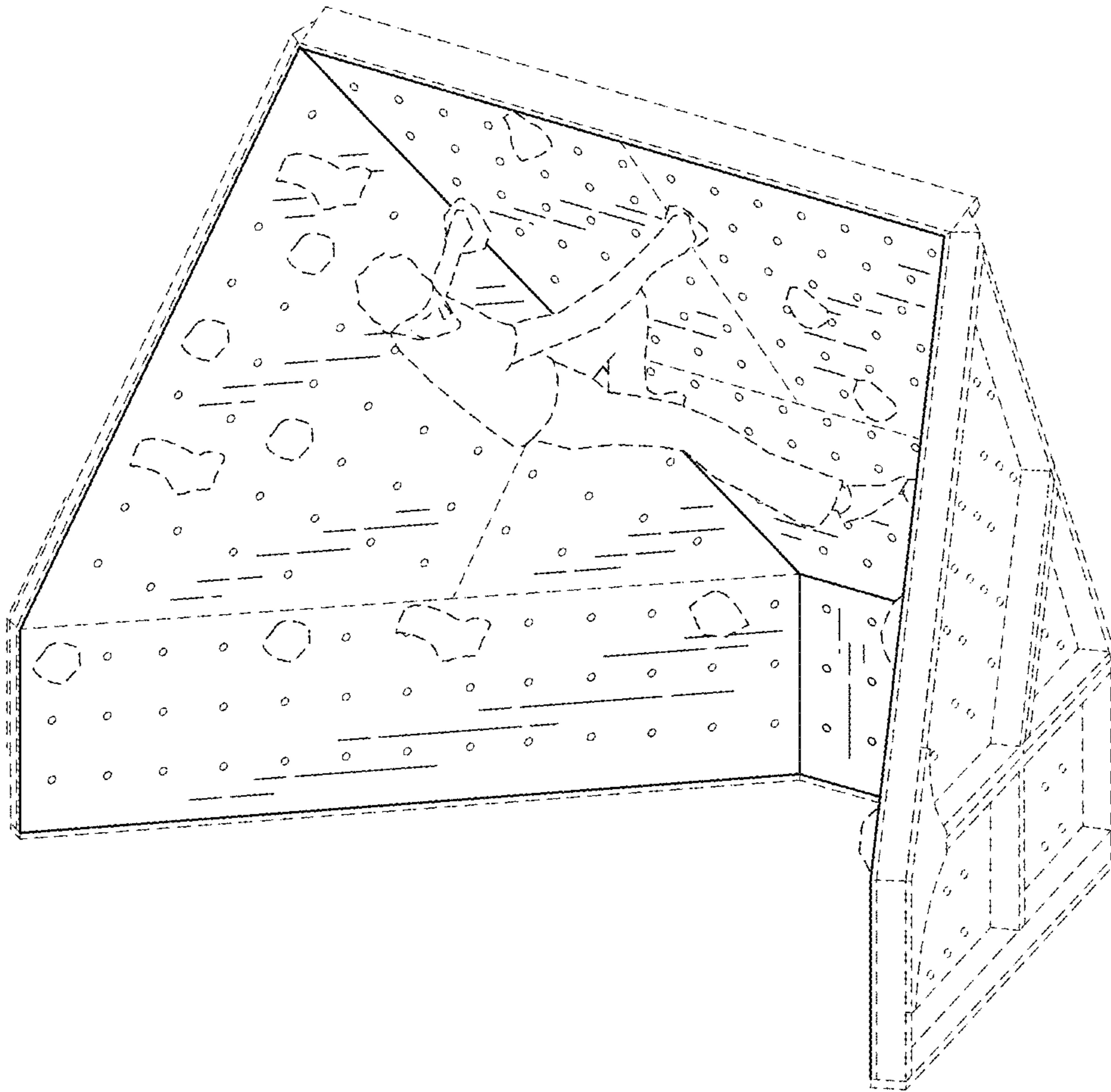

FIG.57

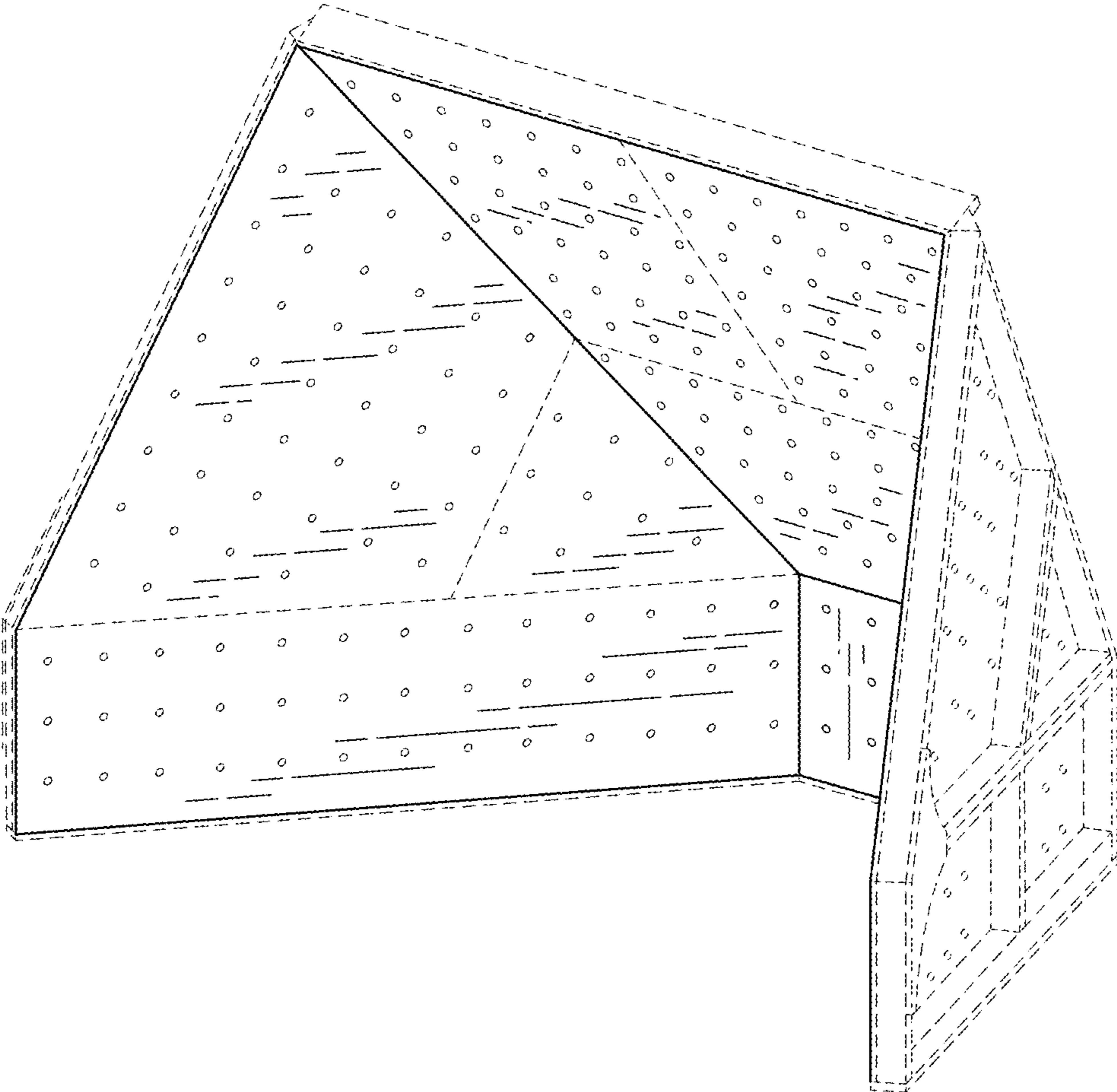

FIG.58

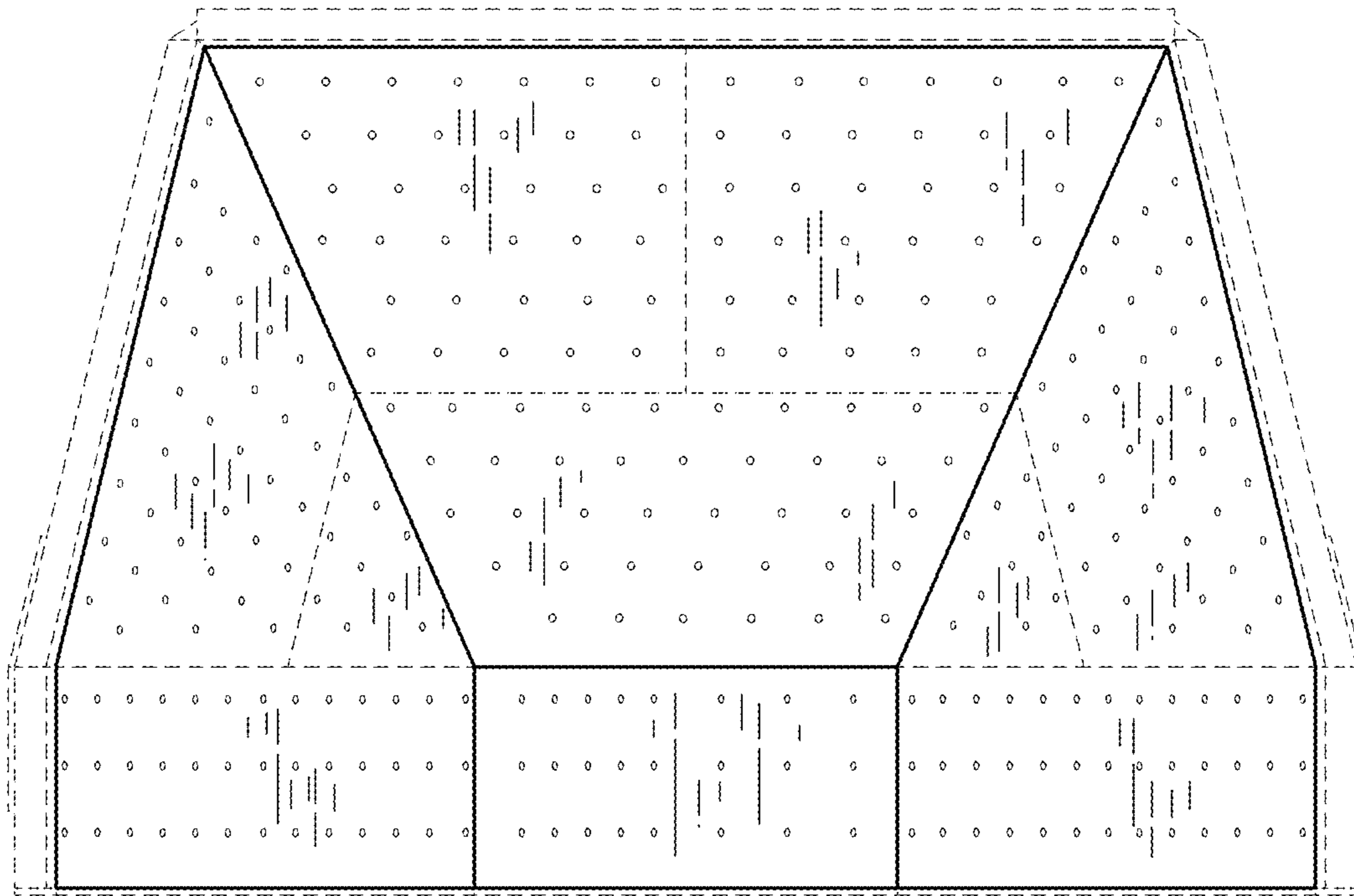

FIG.59

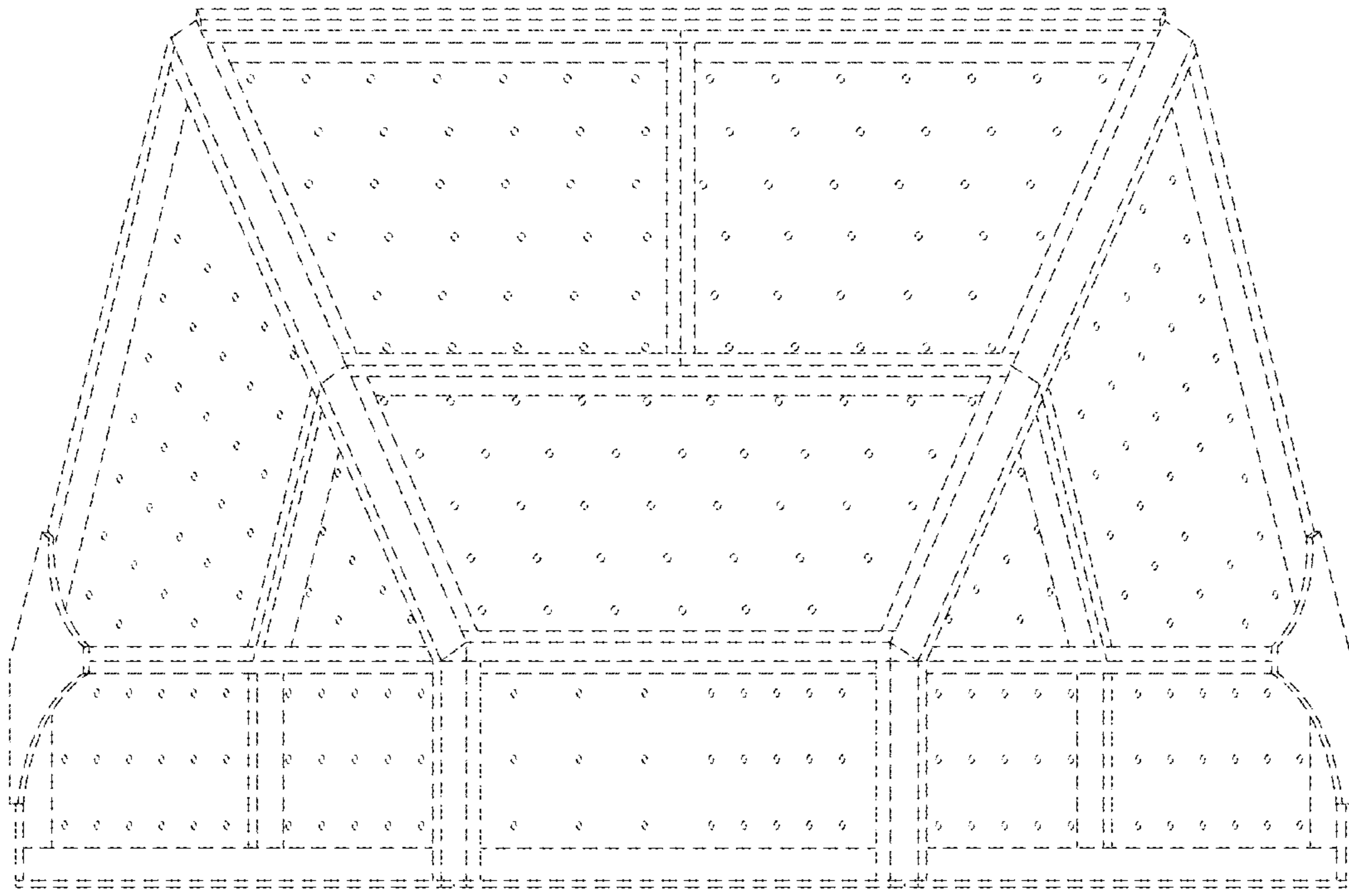

FIG.60

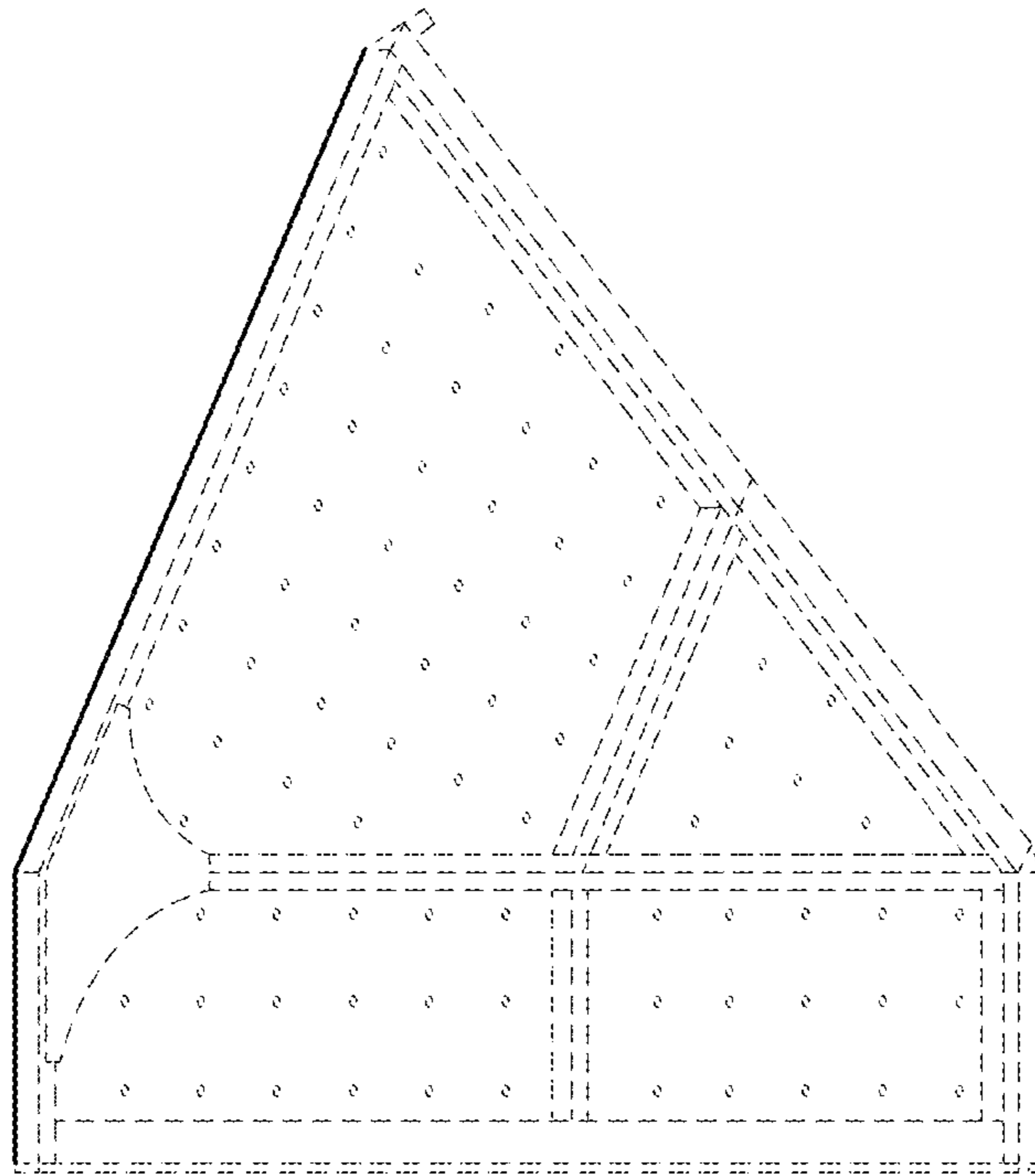

FIG.61

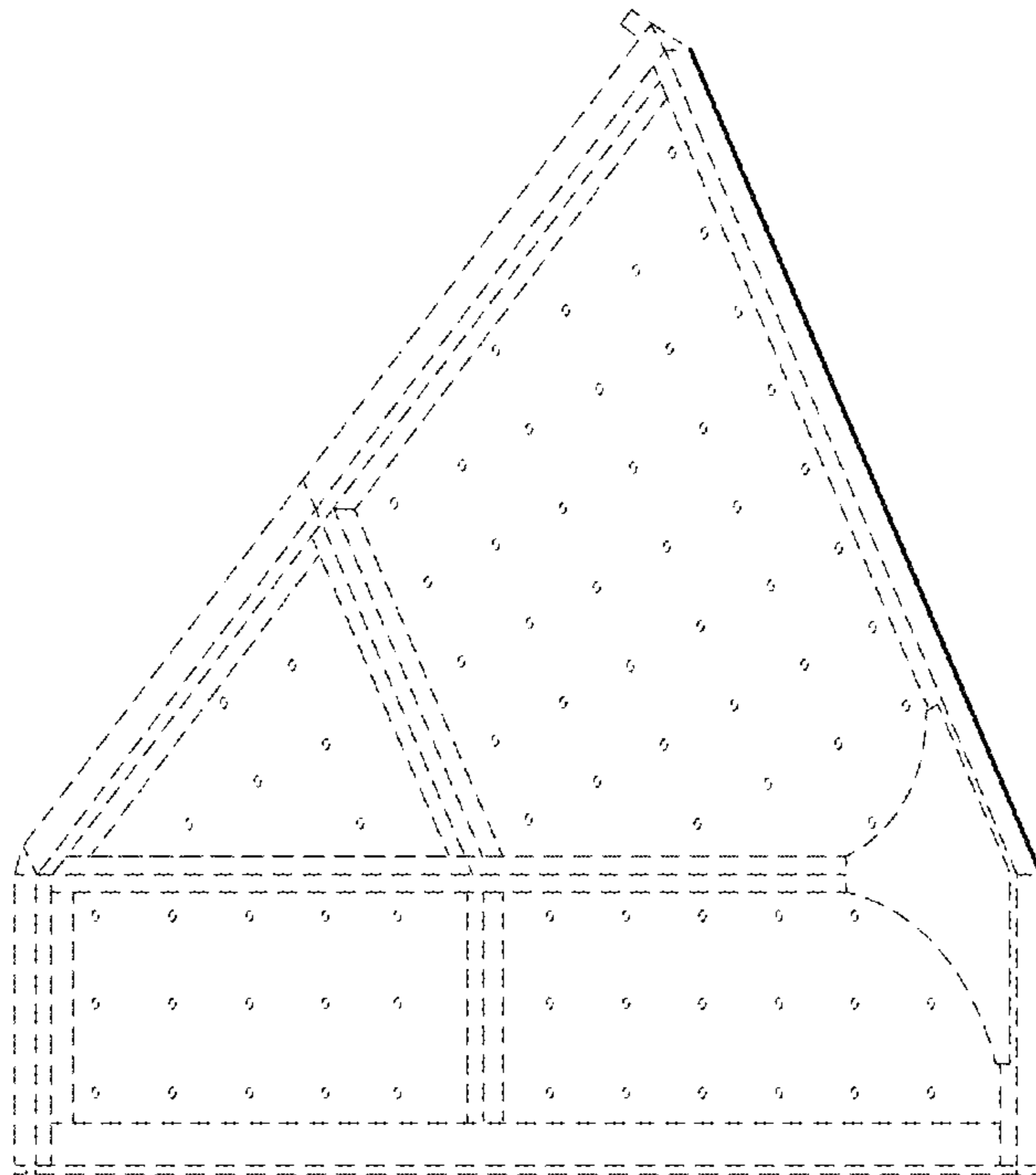

FIG.62

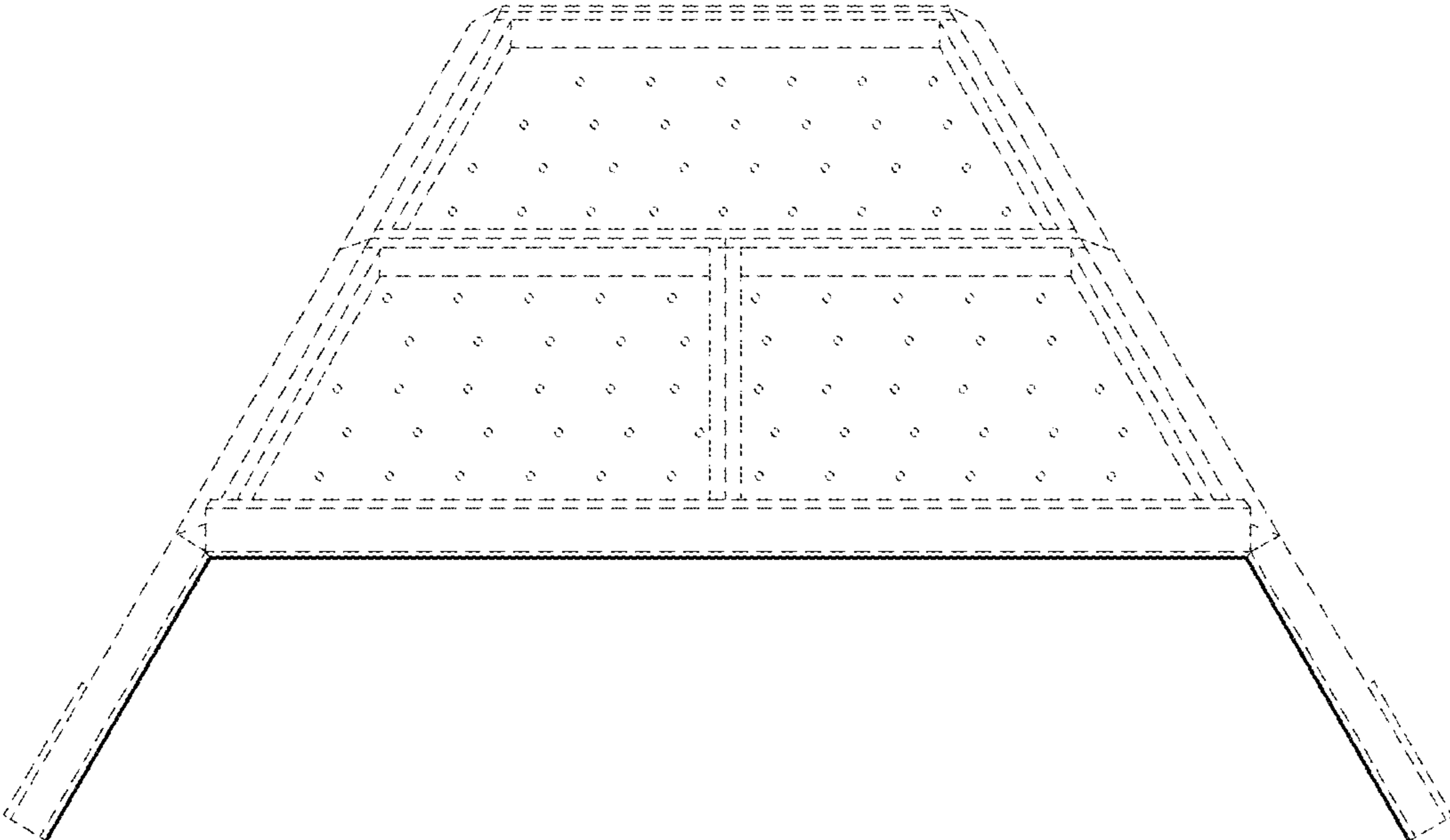

FIG.63

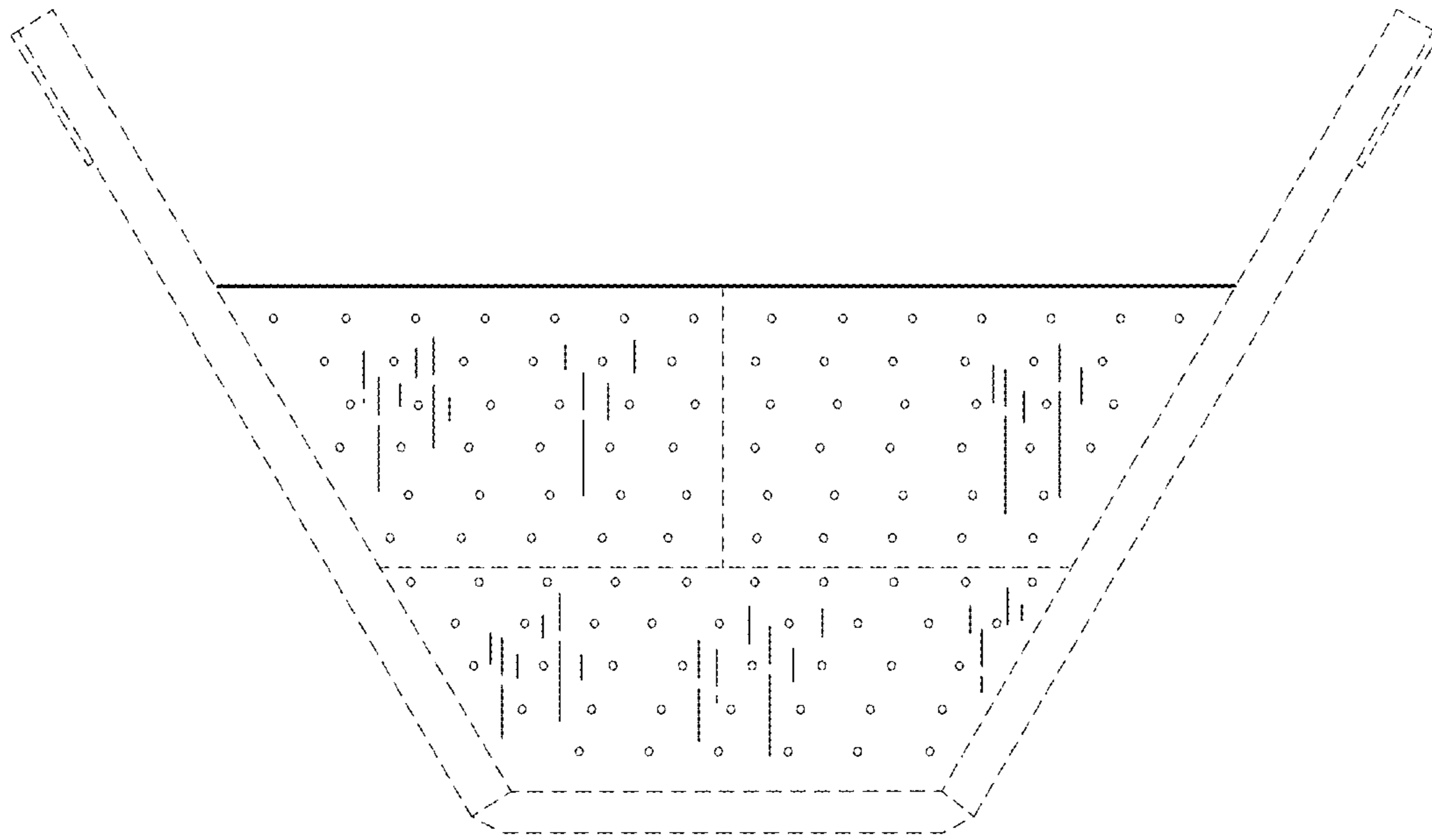

FIG.64