



US00D978981S

(12) **United States Design Patent** (10) **Patent No.:** **US D978,981 S**  
**Chen** (45) **Date of Patent:** **\*\* Feb. 21, 2023**

(54) **CONSTRUCTION TOY**

(71) Applicant: **Yingfan Chen**, Guangzhou (CN)

(72) Inventor: **Yingfan Chen**, Guangzhou (CN)

(\*\*) Term: **15 Years**

(21) Appl. No.: **29/769,856**

(22) Filed: **Feb. 8, 2021**

(51) **LOC (14) Cl.** ..... **21-01**

(52) **U.S. Cl.**  
USPC ..... **D21/496**; D11/117

(58) **Field of Classification Search**  
USPC ..... D21/484–505; D11/68, 117  
CPC ..... A63H 33/04; A63H 33/06; A63H 33/062;  
A63H 33/08; A63H 33/082; A63H  
33/084; A63H 33/086; A63H 33/088  
See application file for complete search history.

(56) **References Cited**

**U.S. PATENT DOCUMENTS**

D141,961 S *	8/1945	Katz	.....	D11/68
2,466,805 A *	4/1949	Griffin	.....	A63H 33/04 273/157 R
D223,313 S *	4/1972	White	.....	D3/903
3,673,909 A *	7/1972	Birnkrant	.....	G10D 13/08 84/404
D246,294 S *	11/1977	Hetherington	.....	D11/117
D309,639 S *	7/1990	Knudsen	.....	D11/118
D309,640 S *	7/1990	Knudsen	.....	D21/496
D371,401 S *	7/1996	Nielsen	.....	D21/496
D394,468 S *	5/1998	Leadbetter	.....	D21/496
D482,412 S *	11/2003	Manville	.....	D21/493
D482,736 S *	11/2003	Manville	.....	D21/484
D630,969 S *	1/2011	Mattis	.....	D11/117
9,238,179 B2 *	1/2016	Carpenter	.....	A63H 33/082
D774,709 S *	12/2016	Kellogg	.....	D30/160
D857,114 S *	8/2019	Fontaine	.....	D21/496
D930,172 S *	9/2021	Lowsky	.....	D24/195
2017/0144081 A1 *	5/2017	Jichi	.....	A63H 33/088

**OTHER PUBLICATIONS**

“Sorting My Collection Continues: I’ll just Leaf These Here.”  
Posted on ramblingbrick.com Aug. 16, 2017 [online], [site visited  
Oct. 7, 2022]. Available from Internet: <URL:https://ramblingbrick.  
com/2017/08/16/sorting-my-collection-continues-ill-just-leaf-these-  
here/> (Year: 2017).\*

Lego Xtra 40310 Botanical Accessories—Short Presentation, uploaded  
by AustrianBrickFan Aug. 12, 2018 [online], [site visited Oct. 7,  
2022]. Available from Internet: <URL:https://www.youtube.com/  
watch?v=PdPBzvBNA2Y> (Year: 2018).\*

Lego Plate 1x1 with 3 Plant Leaves (32607), available since 2018  
[online], [site visited Oct. 7, 2022]. Available from Internet:  
<URL:https://www.brickowl.com/catalog/lego-plate-1-x-1-with-3-  
plant-leaves-32607> (Year: 2018).\*

\* cited by examiner

*Primary Examiner* — Cynthia M. Chin

(74) *Attorney, Agent, or Firm* — Morgan, Lewis &  
Bockius LLP

(57) **CLAIM**

The ornamental design for a construction toy, as shown and  
described.

**DESCRIPTION**

FIG. 1 is a front, left and bottom perspective view of a  
construction toy showing my new design;  
FIG. 2 is a rear, left and top perspective view thereof;  
FIG. 3 is a front elevational view thereof;  
FIG. 4 is a rear elevational view thereof;  
FIG. 5 is a left side view thereof;  
FIG. 6 is a right side view thereof;  
FIG. 7 is a top plan view thereof;  
FIG. 8 is a bottom plan view thereof; and,  
FIG. 9 is a sectional view thereof, taken in the direction of  
**9-9** in FIG. 3.

The broken lines in the drawings illustrate the portions of the  
construction toy that form no part of the claim.

**1 Claim, 9 Drawing Sheets**

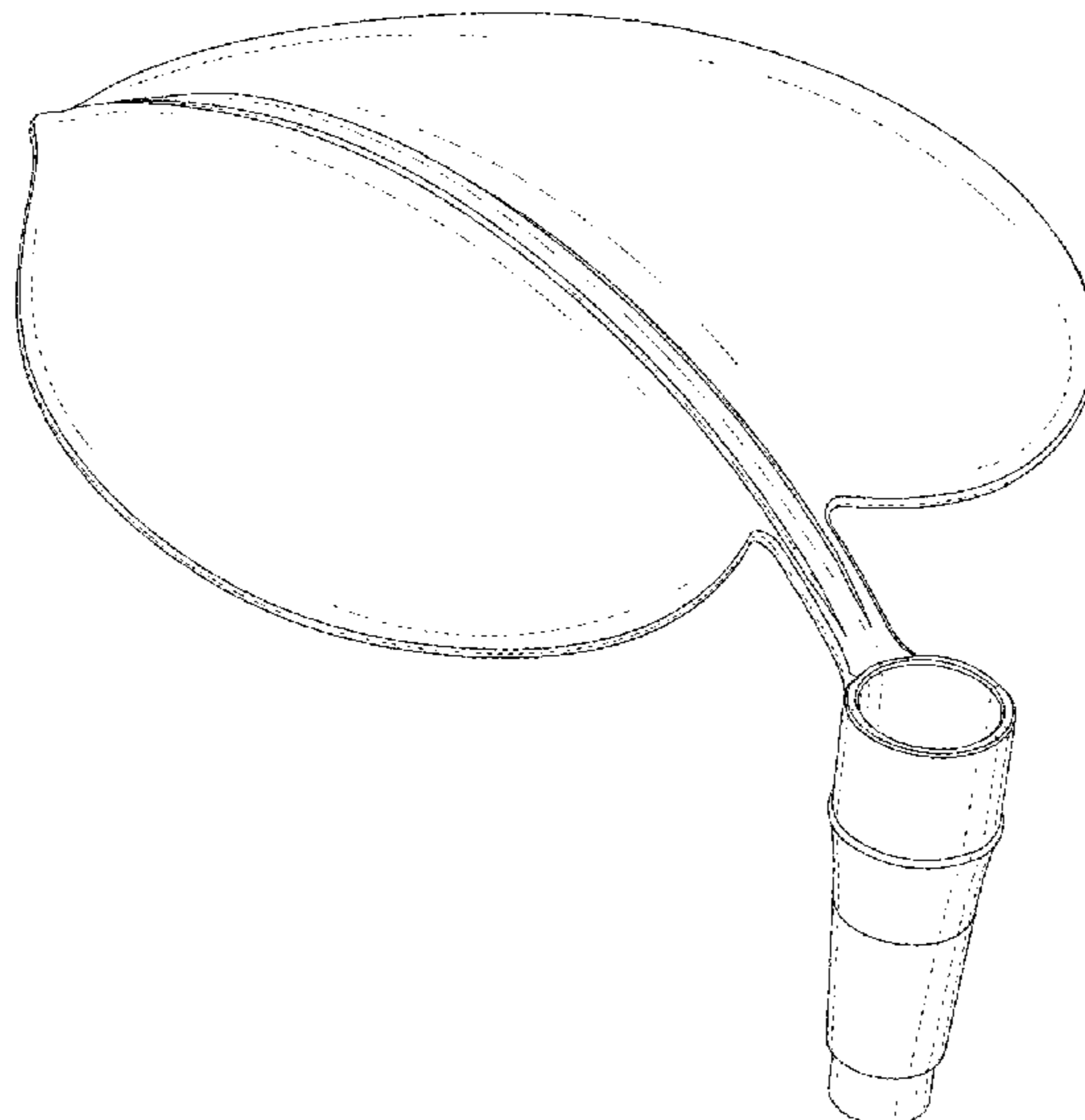

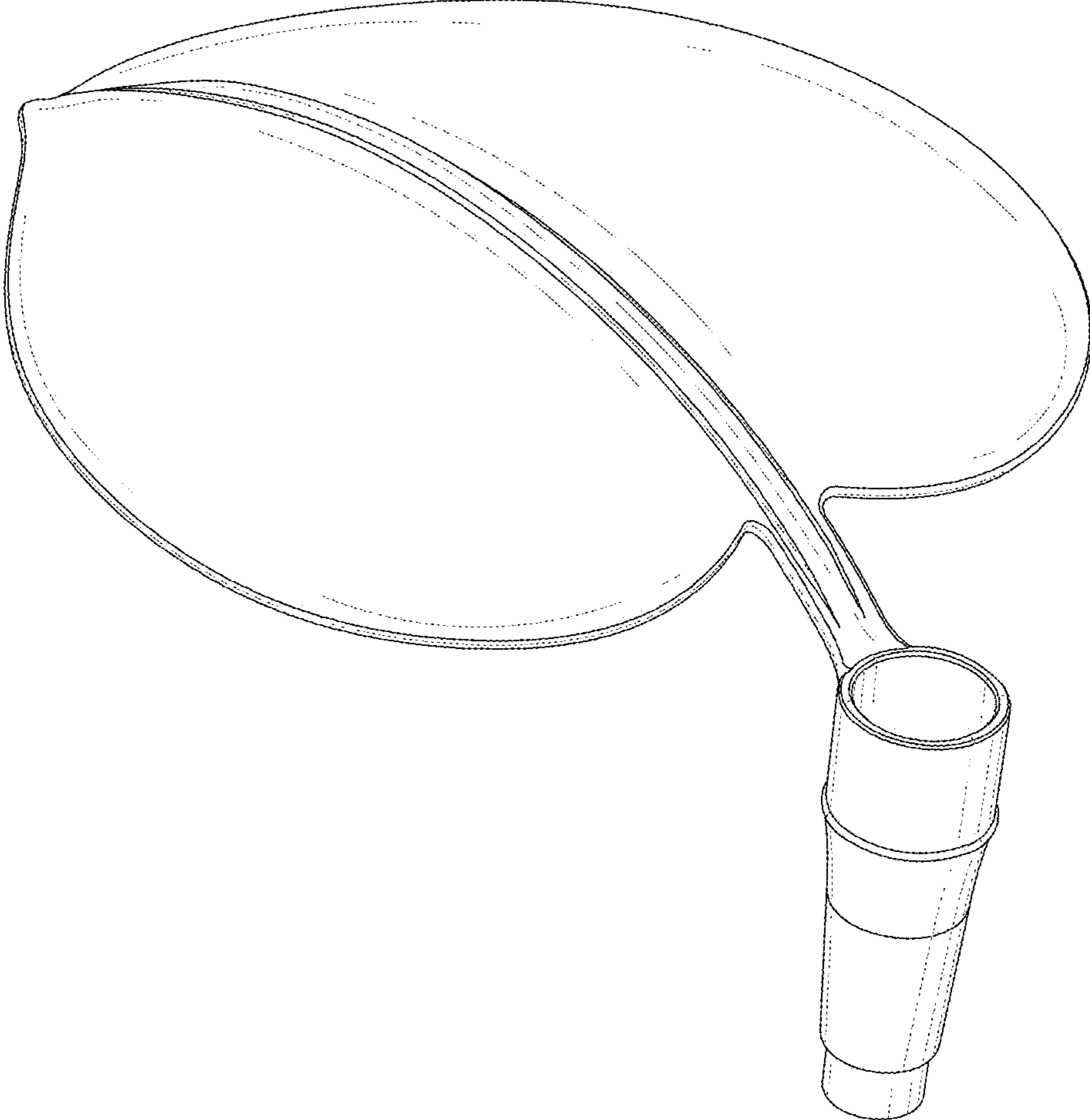

Fig. 1

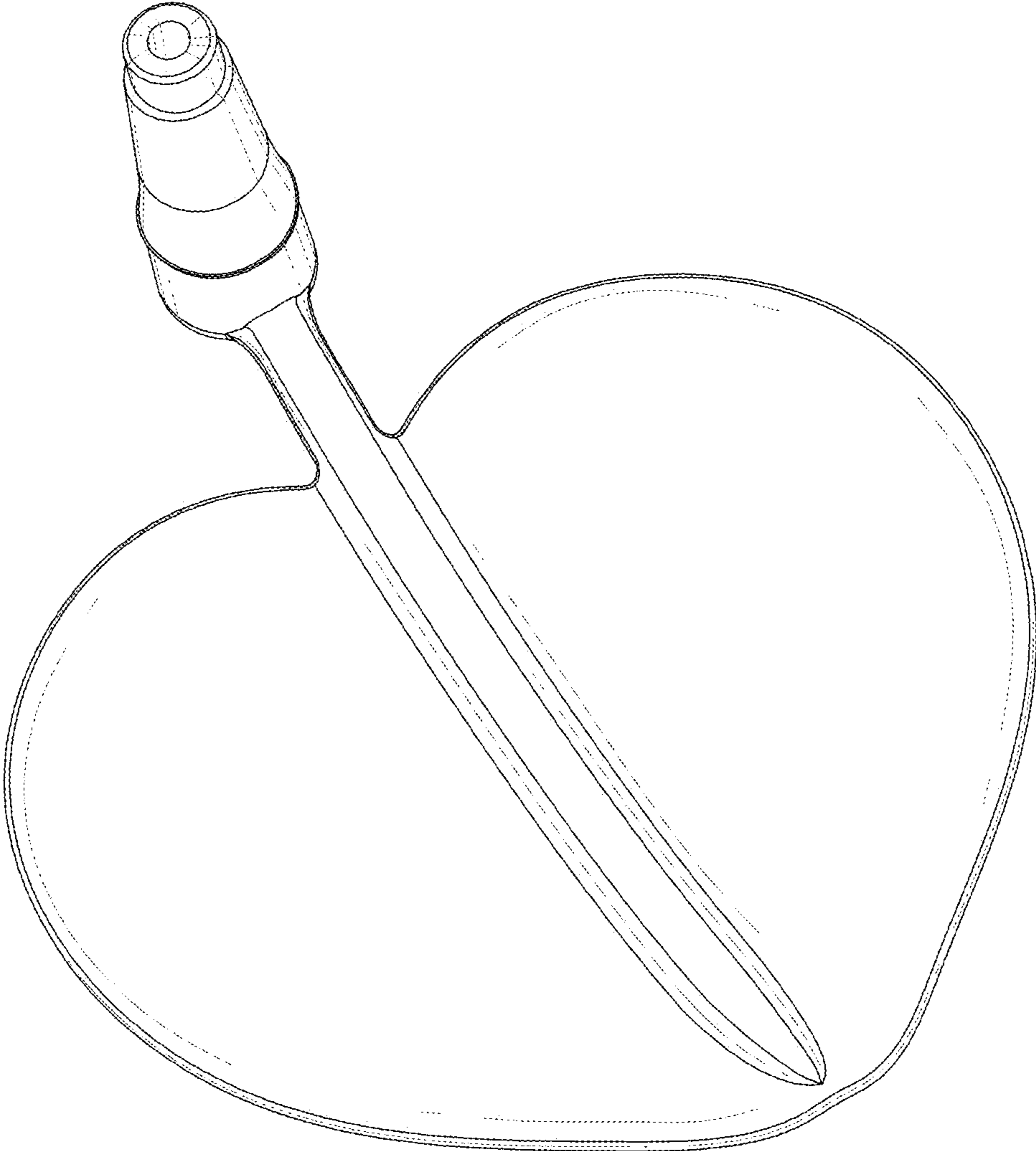

Fig.2

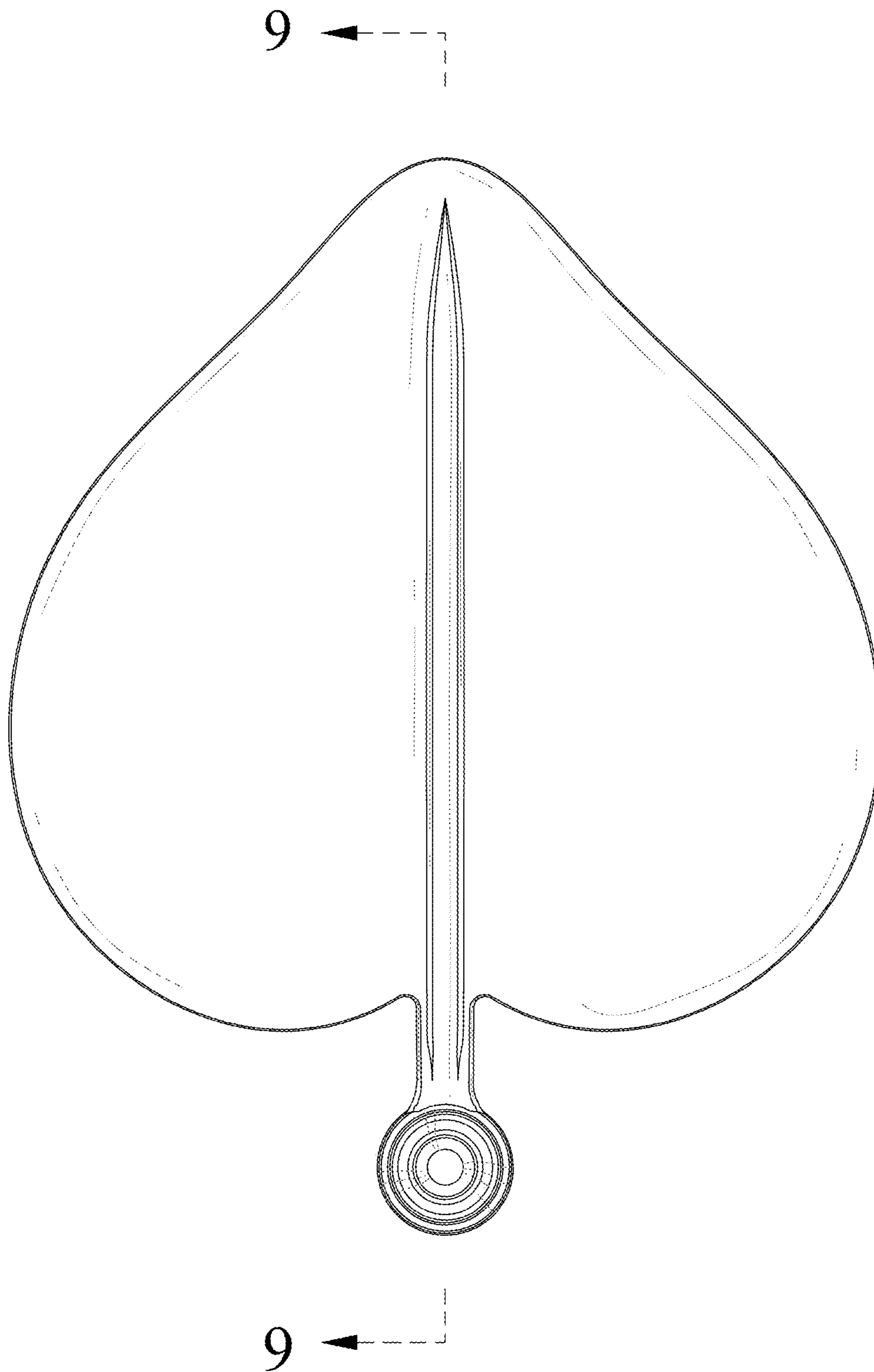

Fig.3

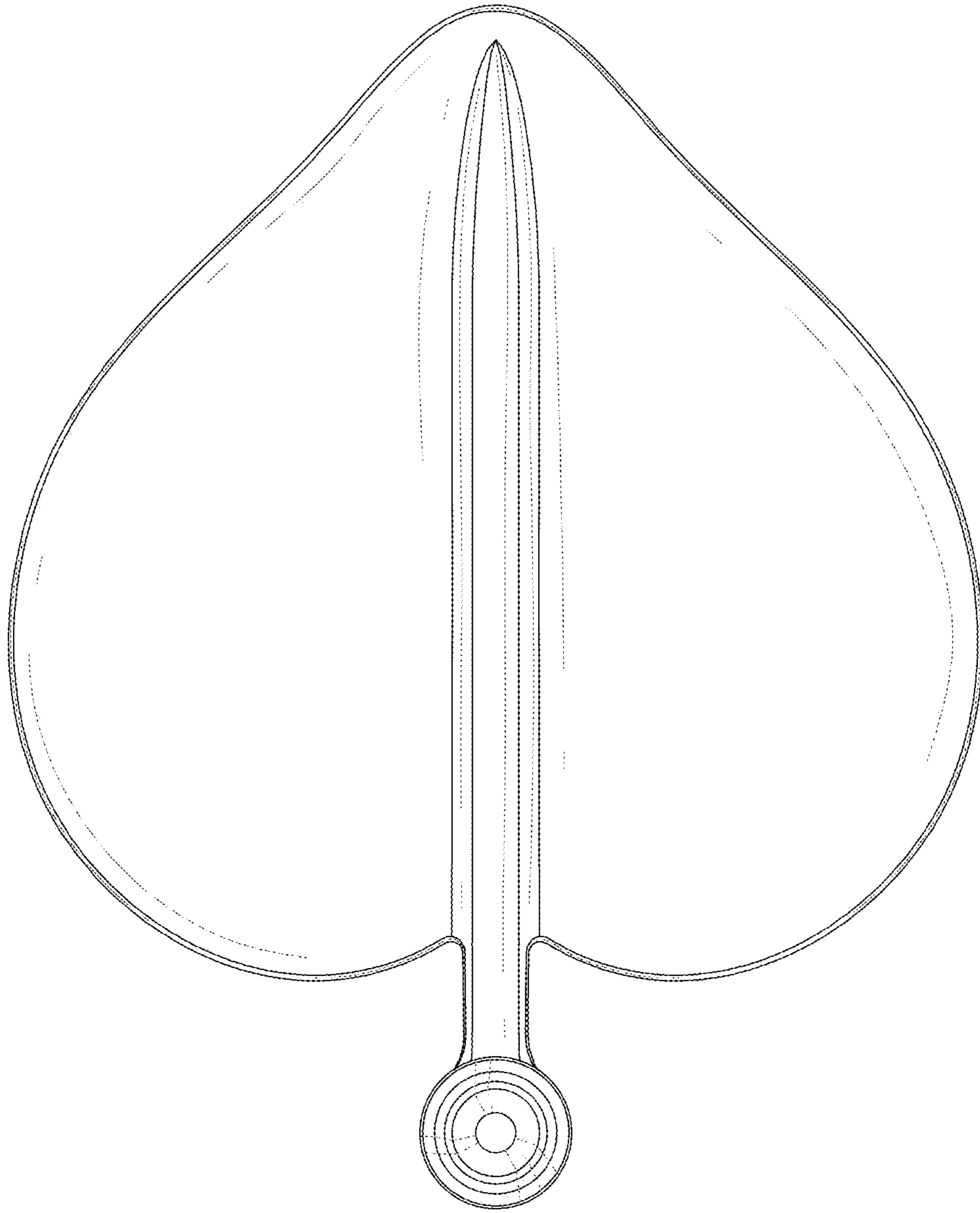

Fig. 4



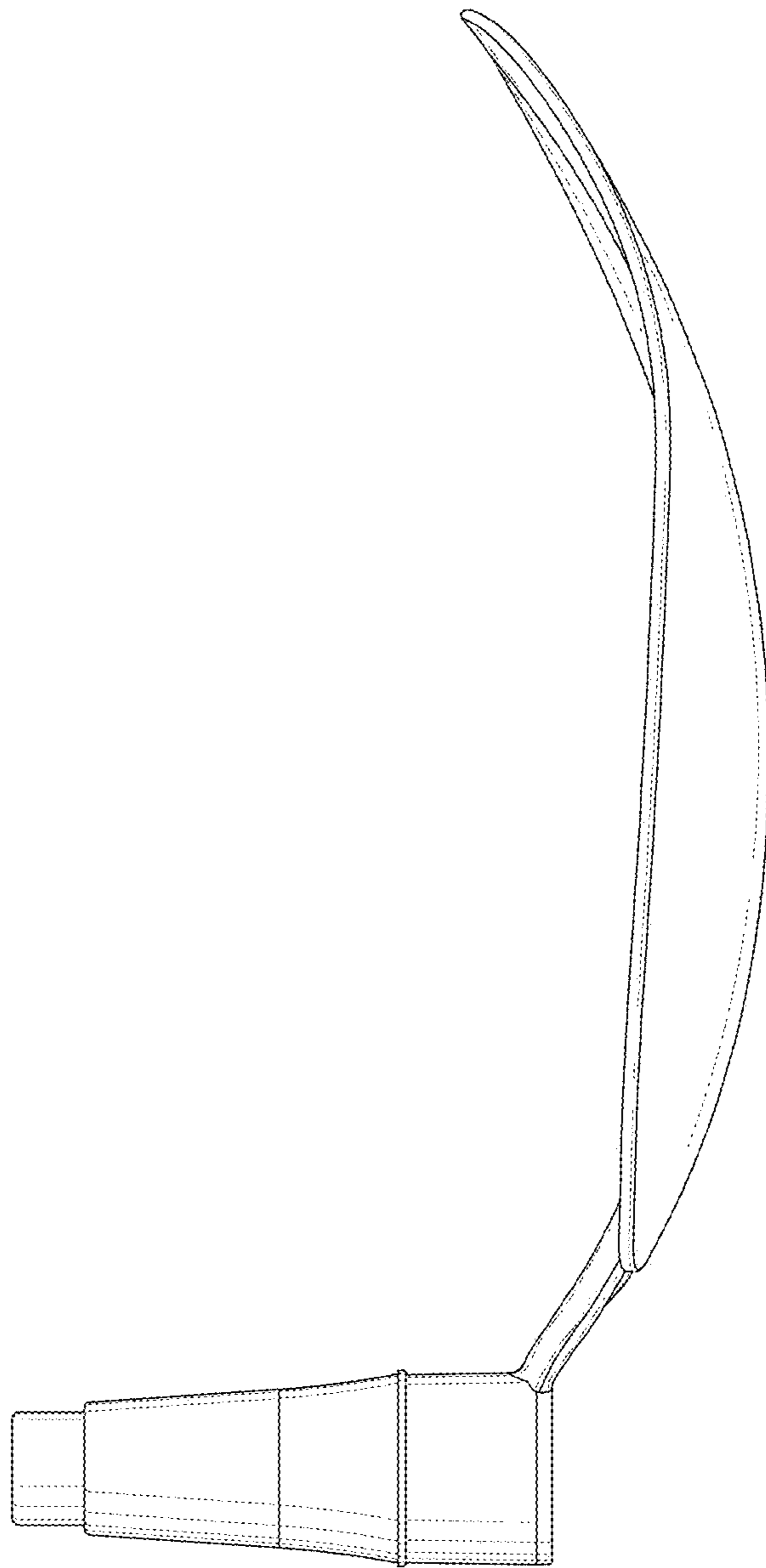

Fig. 5

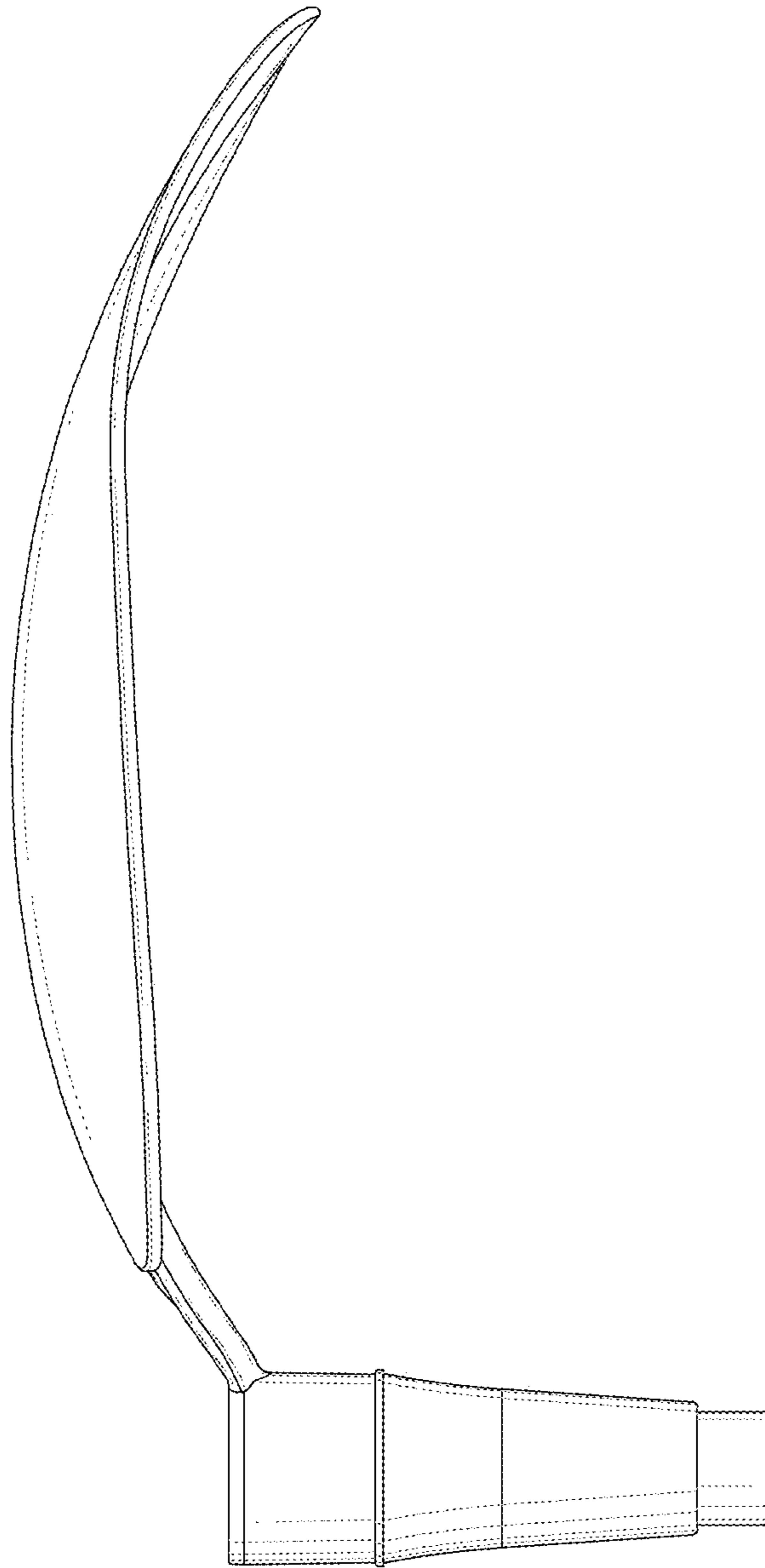

Fig. 6

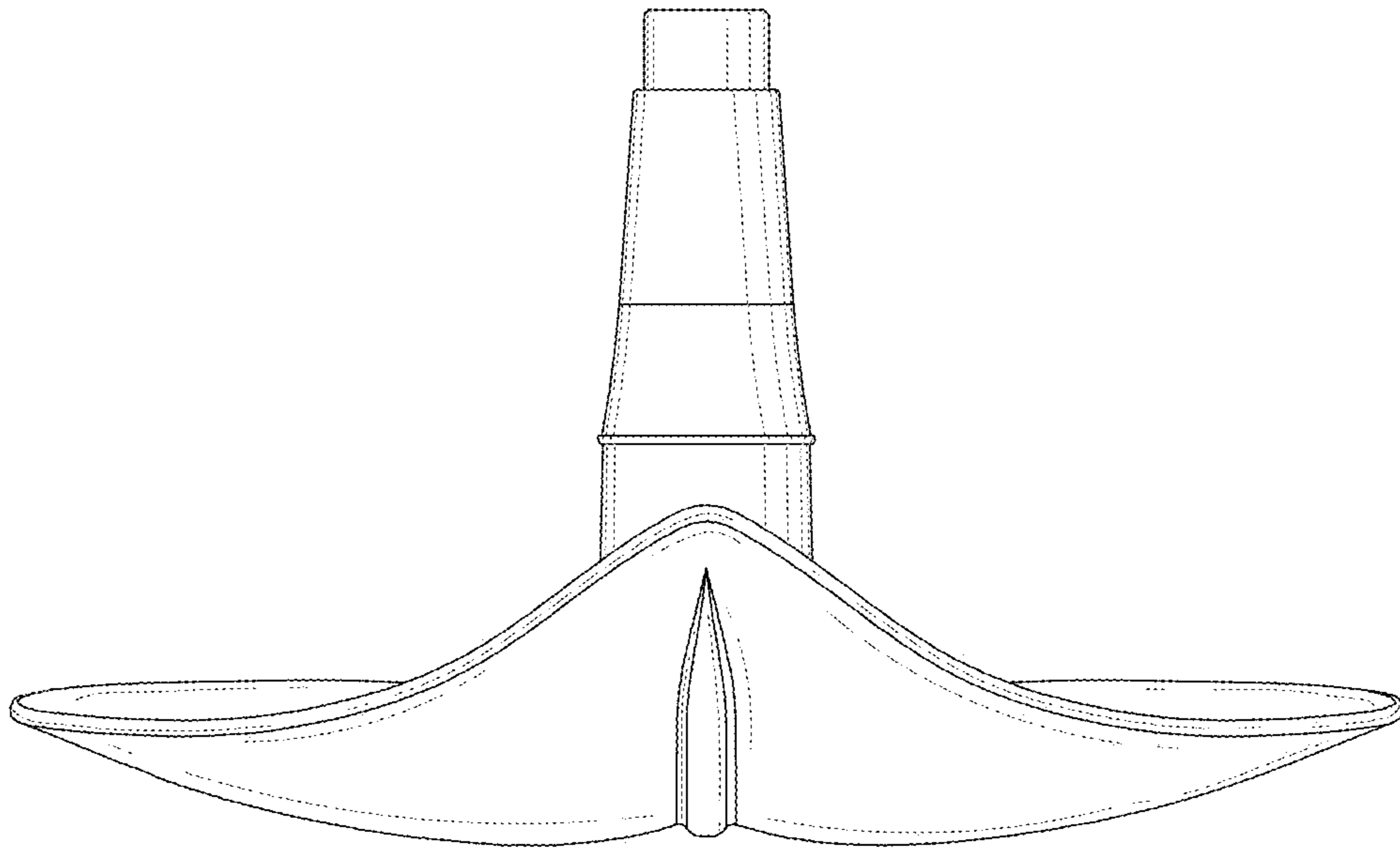

Fig. 7



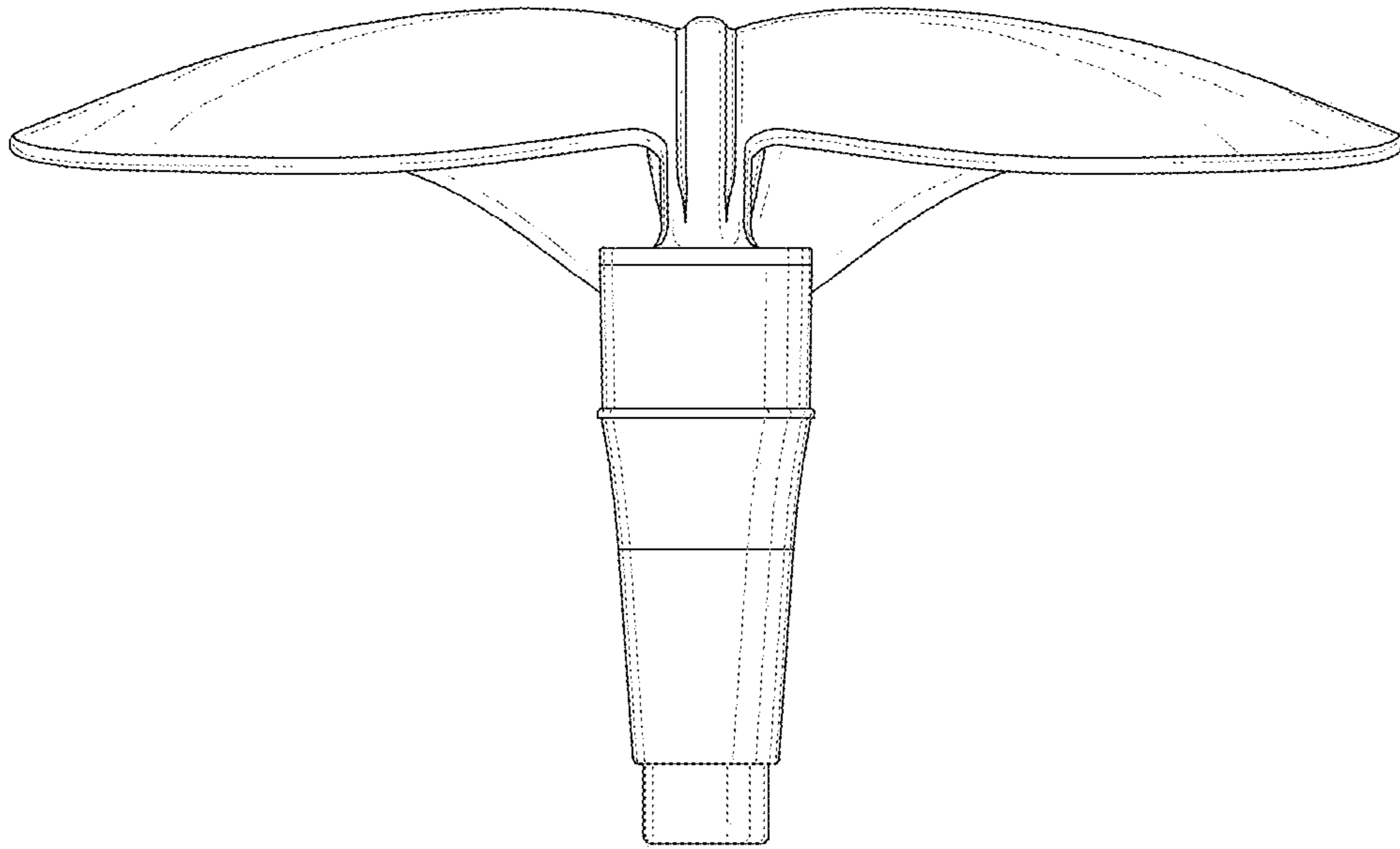

Fig. 8

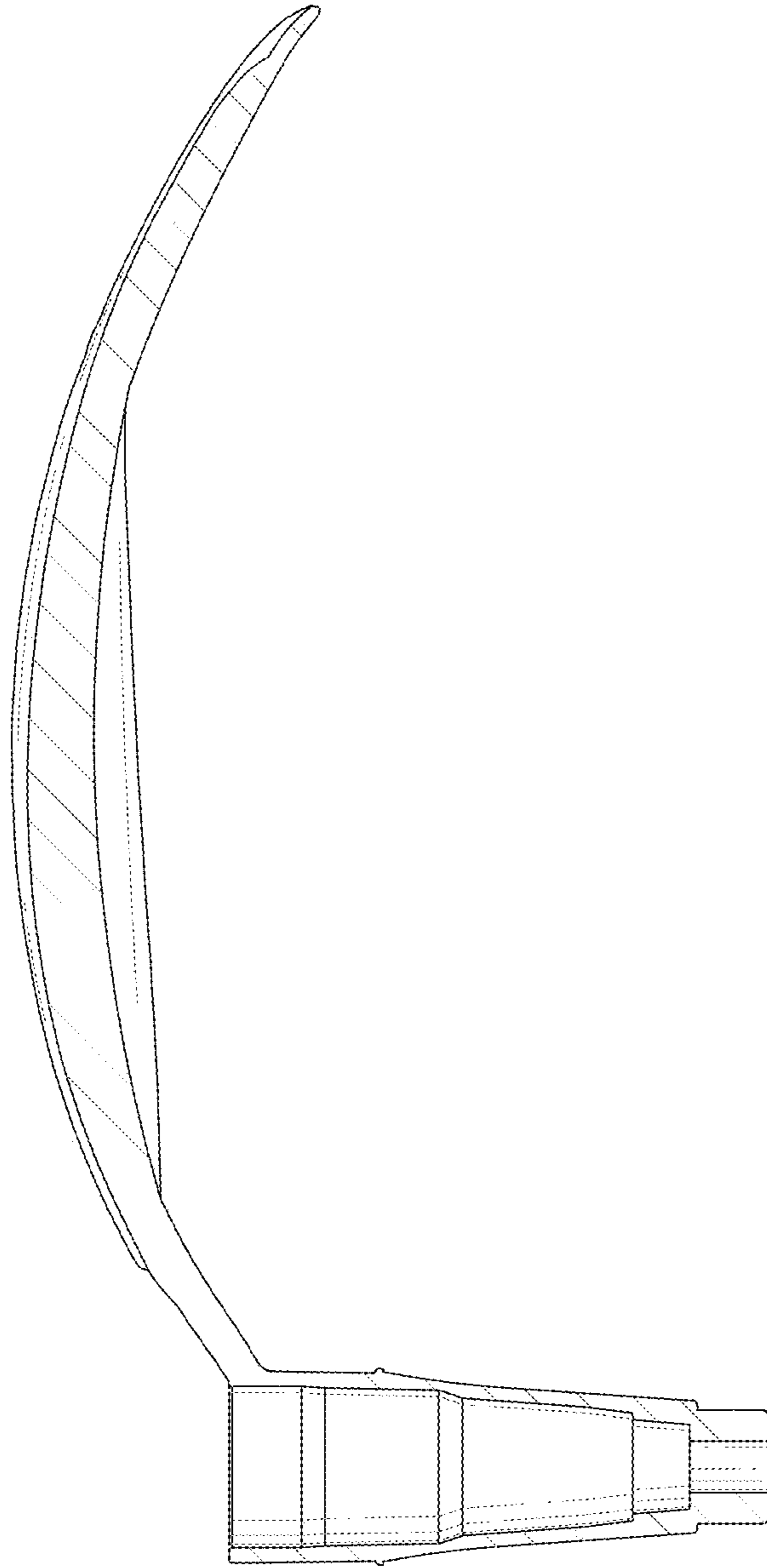

Fig.9