



US00D978971S

(12) **United States Design Patent**
Yuan

(10) **Patent No.:** **US D978,971 S**
(45) **Date of Patent:** **** Feb. 21, 2023**

(54) **GAME CONTROLLER**

(71) Applicant: **Huihui Yuan**, Loudi (CN)

(72) Inventor: **Huihui Yuan**, Loudi (CN)

(**) Term: **15 Years**

(21) Appl. No.: **29/861,286**

(22) Filed: **Nov. 29, 2022**

(51) **LOC (14) Cl.** **21-01**

(52) **U.S. Cl.**
USPC **D21/333**

(58) **Field of Classification Search**
USPC D21/324–329, 330, 332, 333, 566;
D14/125–126, 127–137, 138, 168,
D14/217–218, 248, 315–318, 322, 326,
D14/334–336, 339, 340–347, 356,
D14/387–389, 399–401, 405–410,
D14/412–416, 421–430, 443, 449–450,
D14/454, 474, 483, 496; D6/300, 310,
D6/314, 320, 332, 553, 657; D10/50, 65,
D10/104.1; D18/6, 7; D19/26, 59–60
CPC A63F 9/00; A63F 9/24; A63F 11/00; A63F
13/02; A63F 13/06; A63F 13/24; A63F
13/98; H04M 1/0202; H04M 1/0266;
H04M 1/725

See application file for complete search history.

(56) **References Cited**

U.S. PATENT DOCUMENTS

D424,047 S * 5/2000 Chan D14/401
D442,960 S * 5/2001 Brulotte D14/415
D464,968 S * 10/2002 Wahlgren D14/415
D715,296 S * 10/2014 Huang D14/401

D745,607 S * 12/2015 Jones D14/401
D816,083 S * 4/2018 Wu D14/401
D875,179 S * 2/2020 Wang D21/333
D887,411 S * 6/2020 Li D14/401
D890,263 S * 7/2020 Tong D21/333
D923,097 S 6/2021 Zhao
D923,100 S * 6/2021 Zhou D21/333
D947,947 S * 4/2022 Luo D21/333
D954,838 S 6/2022 Kobayashi et al.
D961,682 S * 8/2022 Jiang D14/401
D963,650 S * 9/2022 Qin D14/401
D964,463 S 9/2022 Luo
D965,065 S 9/2022 Guo

* cited by examiner

Primary Examiner — Katie Jane Stofko

(74) *Attorney, Agent, or Firm* — Daniel M. Cohn;
Howard M. Cohn

(57) **CLAIM**

The ornamental design for a game controller, as shown and described.

DESCRIPTION

FIG. 1 is a front and top perspective view of a game controller showing my new design;
FIG. 2 is a rear, bottom and left side perspective view thereof;
FIG. 3 is a front elevational view thereof;
FIG. 4 is a rear elevational view thereof;
FIG. 5 is a left side elevational view thereof;
FIG. 6 is a right side elevational view thereof;
FIG. 7 is a top plan view thereof; and,
FIG. 8 is a bottom plan view thereof.

The broken lines in the drawings depict portions of the game controller that form no part of the claimed design.

1 Claim, 8 Drawing Sheets

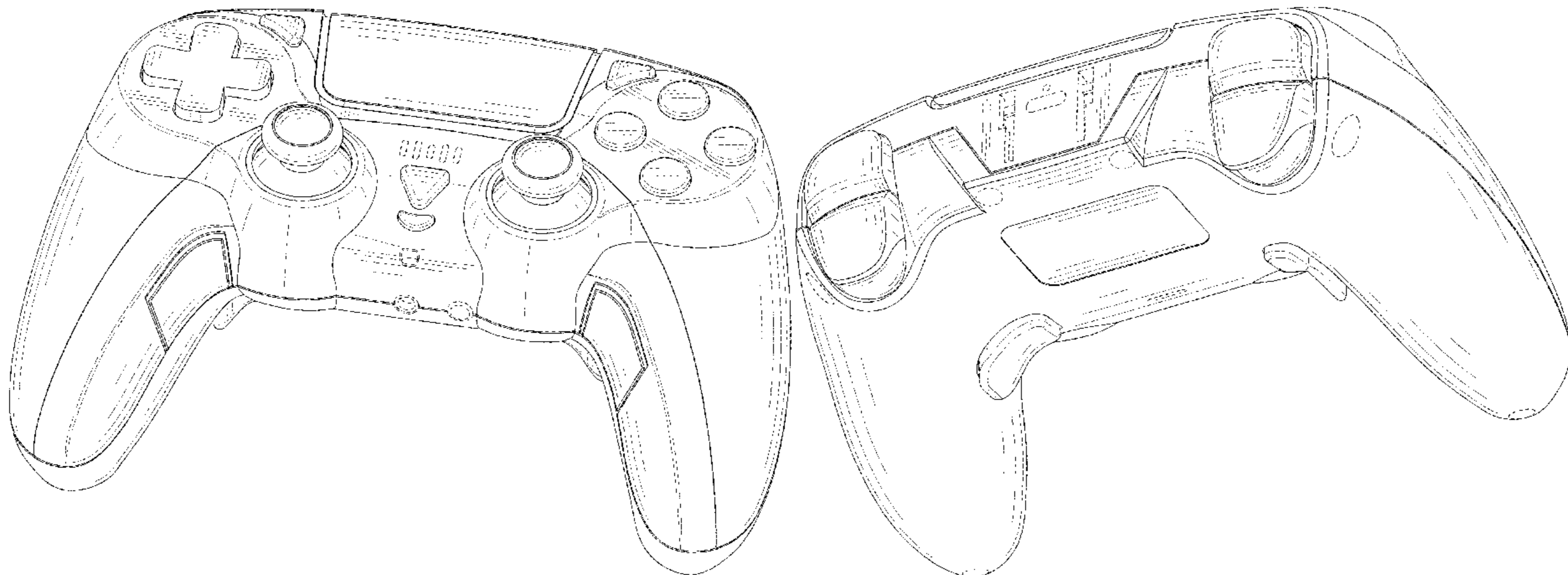

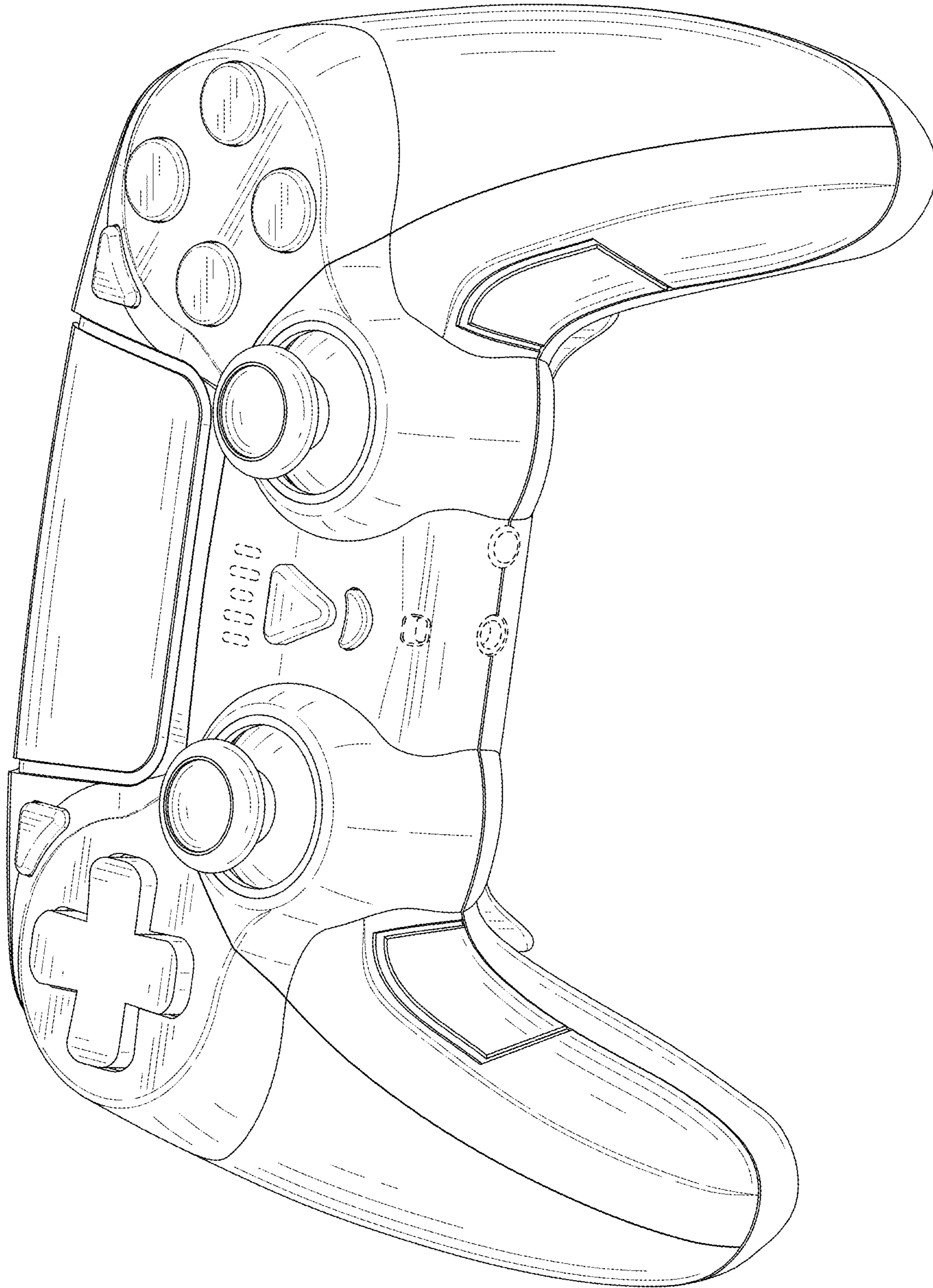

FIG. 1

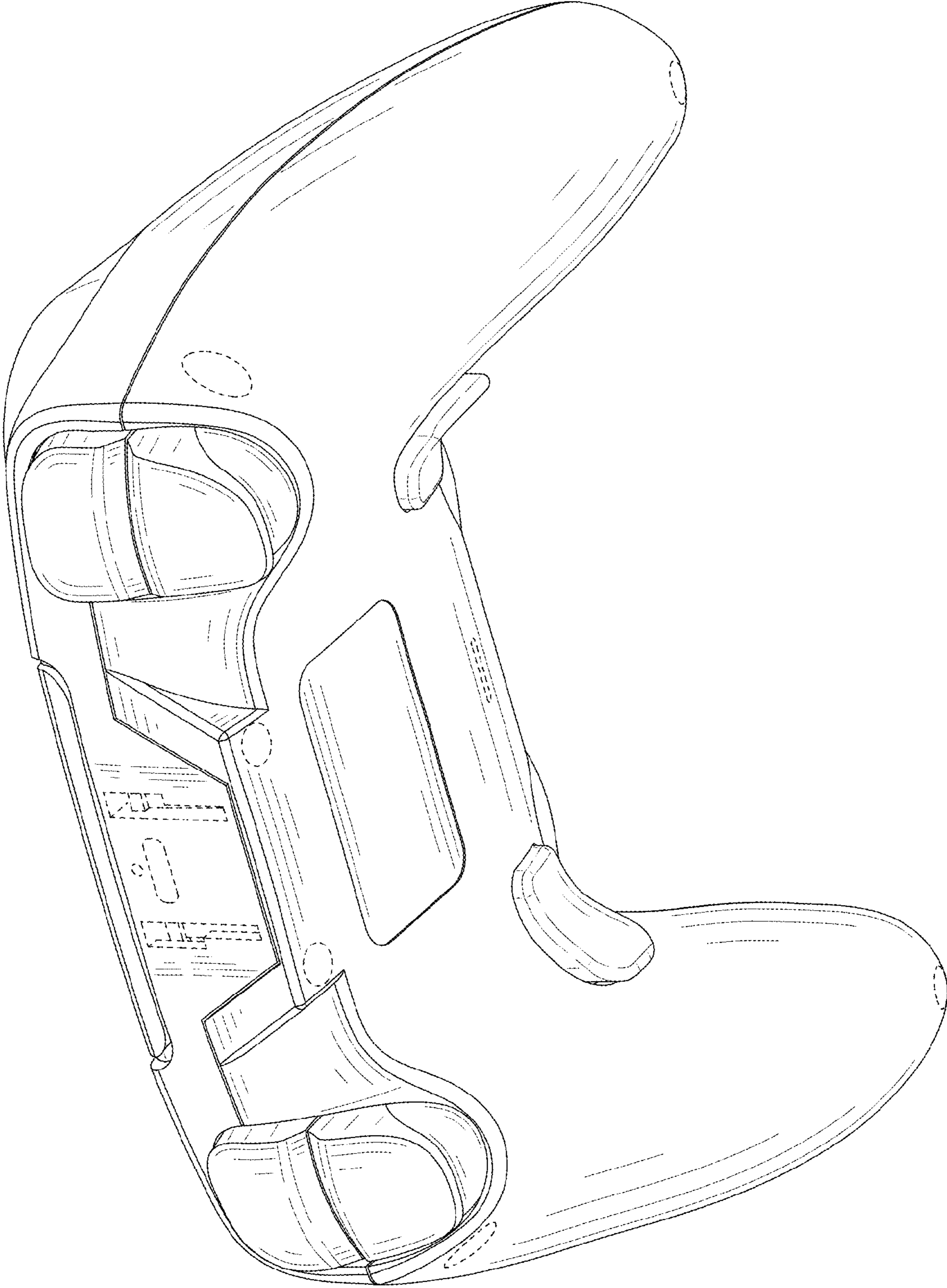

FIG. 2

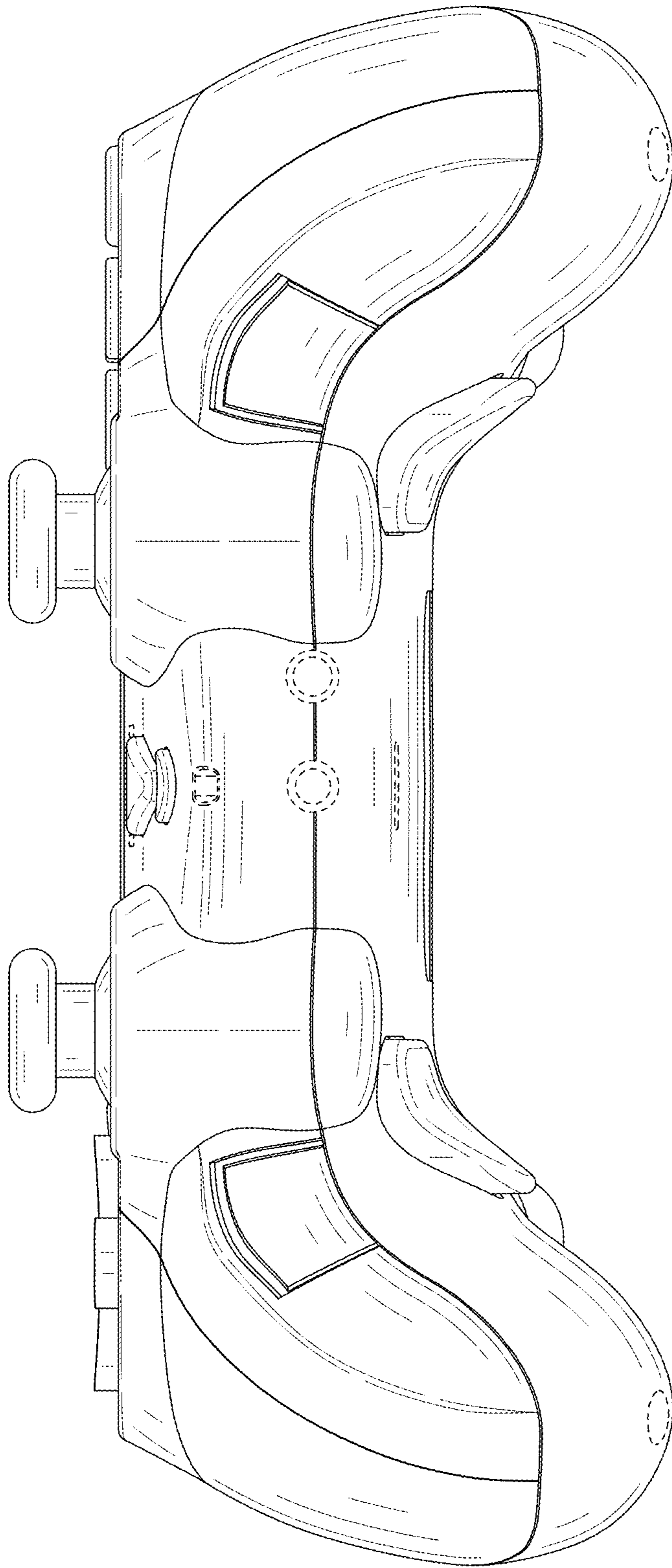

FIG. 3

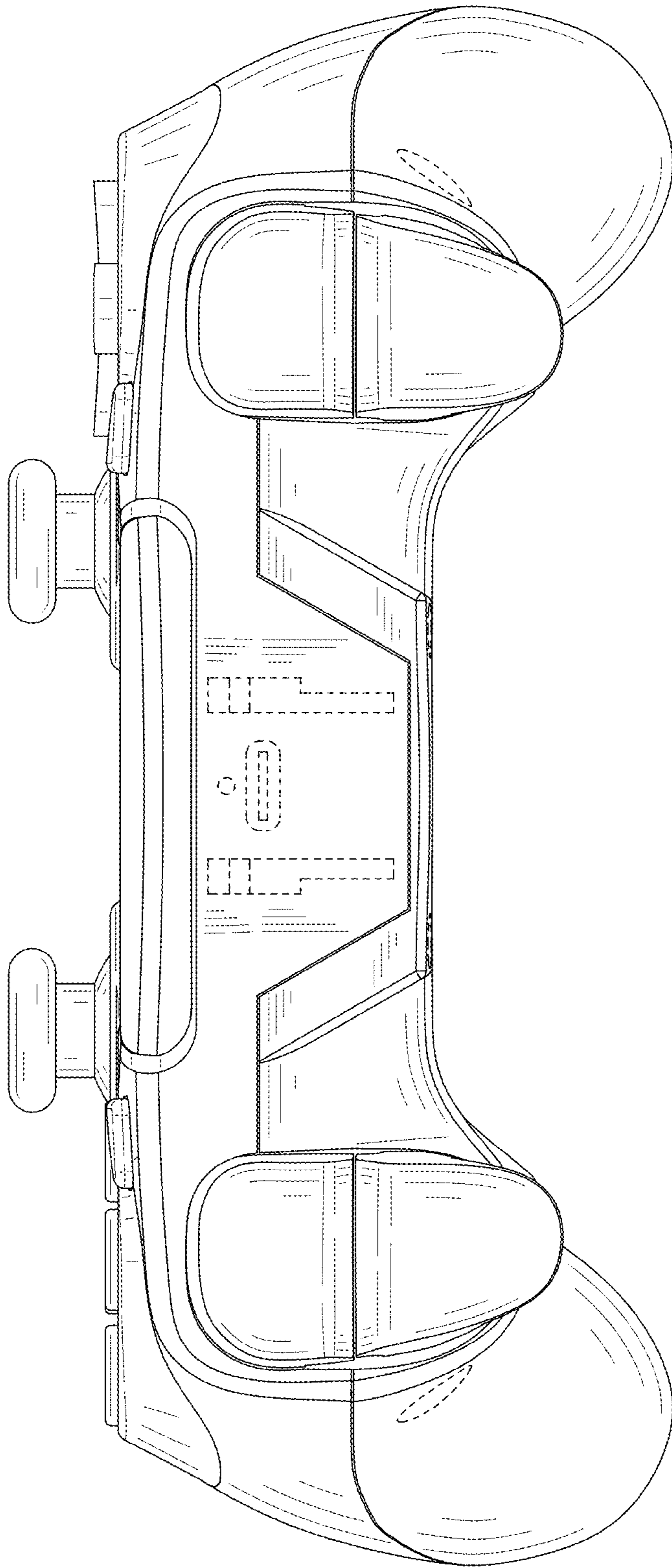

FIG. 4

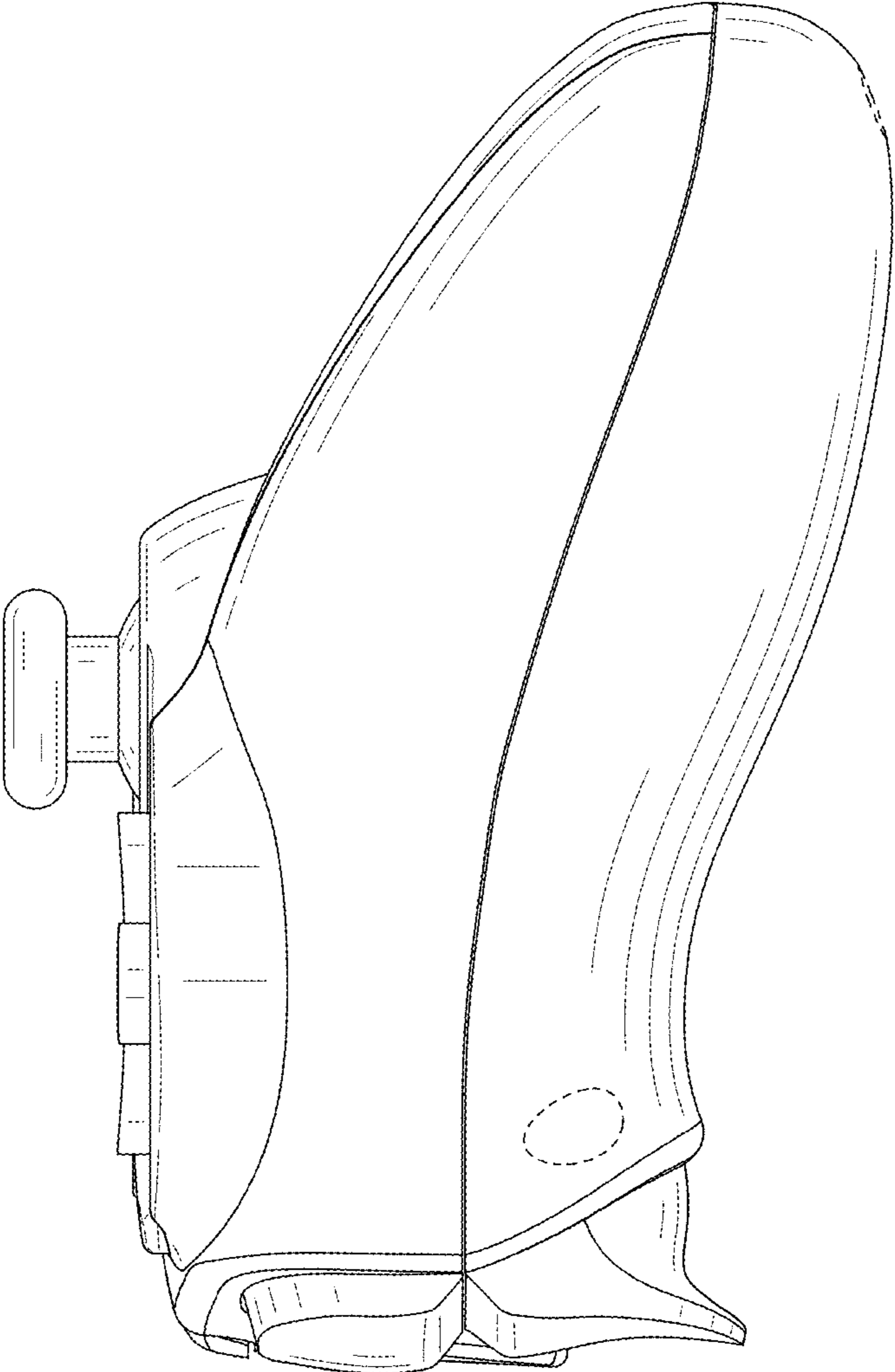

FIG. 5

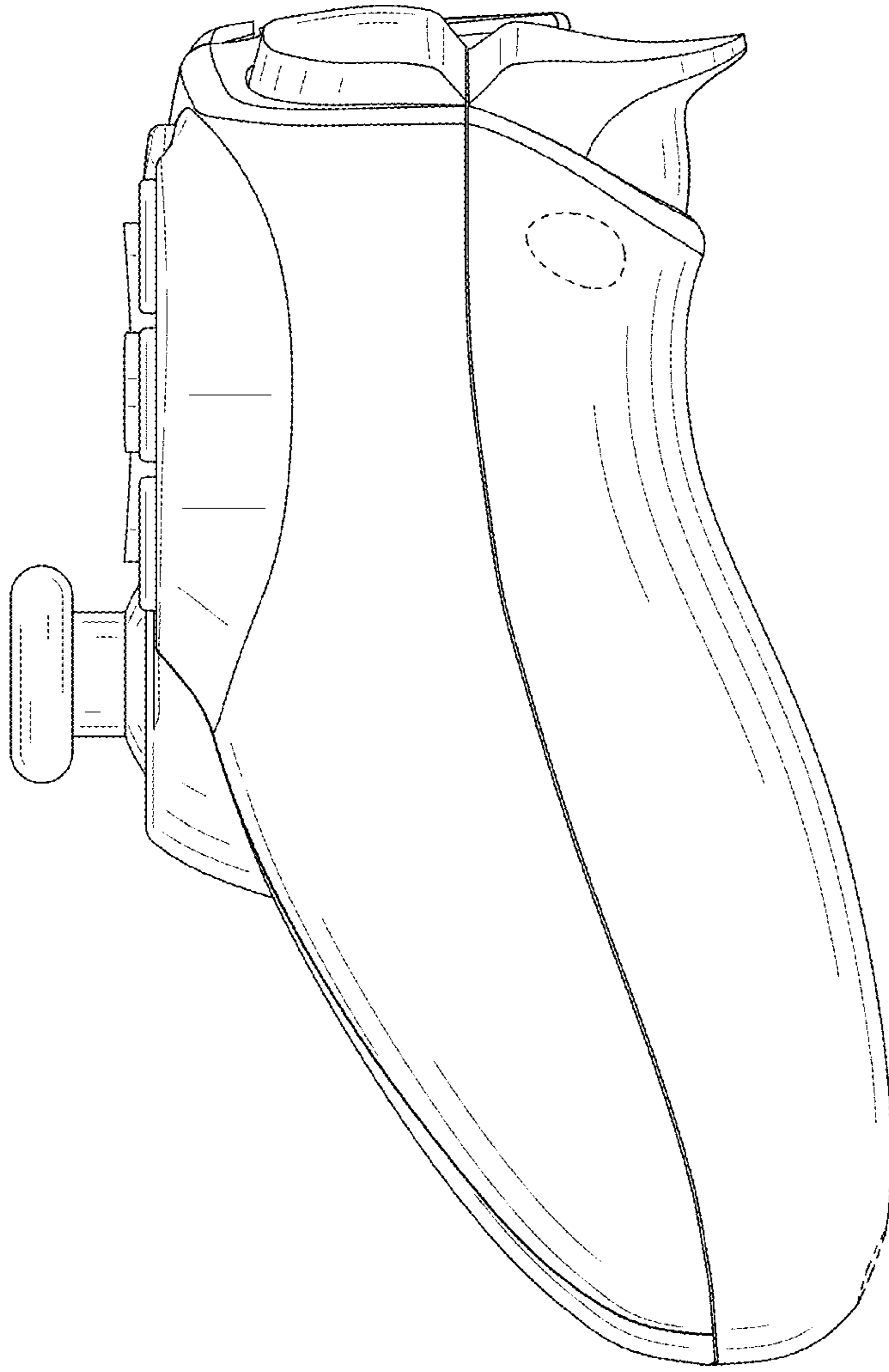

FIG. 6

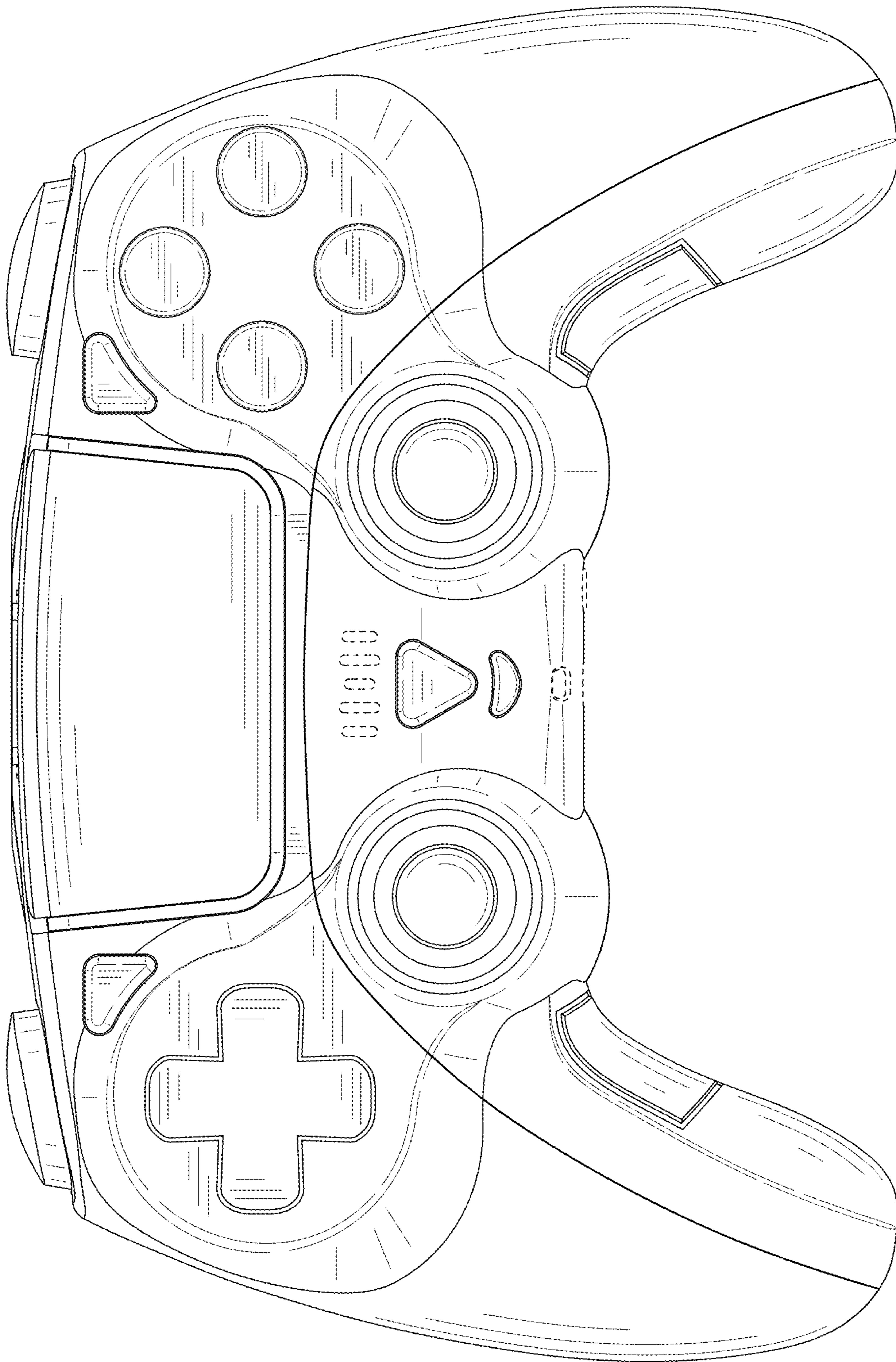

FIG. 7

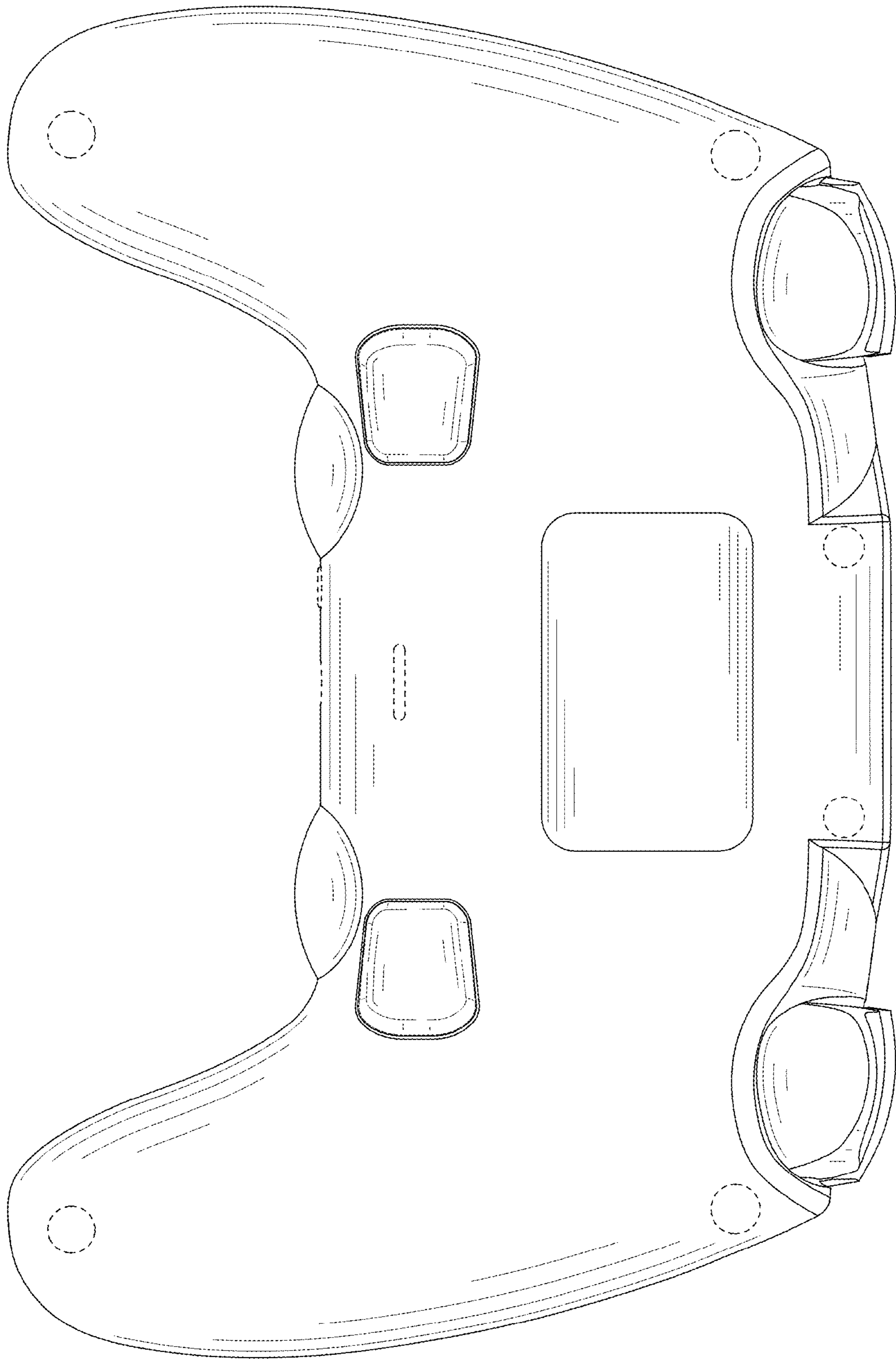

FIG. 8