



US00D978840S

(12) **United States Design Patent**
Blair

(10) **Patent No.:** **US D978,840 S**

(45) **Date of Patent:** **** Feb. 21, 2023**

- (54) **WIRELESS CONTROLLER**
- (71) Applicant: **Sportrax Technology Limited**, London (GB)
- (72) Inventor: **Paul Blair**, London (GB)
- (73) Assignee: **Sportrax Technology Limited**, London (GB)
- (**) Term: **15 Years**
- (21) Appl. No.: **29/762,168**
- (22) Filed: **Dec. 15, 2020**

D844,600 S *	4/2019	Choi	D14/344
D853,261 S *	7/2019	Elangovan	G06F 3/017
				D10/104.1
D873,800 S *	1/2020	Channey	D14/218
10,691,180 B2 *	6/2020	Choi	G06F 3/0346
2006/0164383 A1	7/2006	Machin et al.		
2019/0155385 A1 *	5/2019	Lim	G06F 3/033

FOREIGN PATENT DOCUMENTS

CN	307119134	*	2/2022
KR	300767365.0000	*	10/2014

OTHER PUBLICATIONS

Wearable, first available May 9, 2022 [online], [retrieved Jun. 15, 2022]. Available from the Internet, URL:<<https://www.wearable.com/fashion/best-smart-rings-1340>>. (Year: 2022).*

(Continued)

Primary Examiner — Dana K Weiland
Assistant Examiner — Russell Carnell Smith, Jr.

Related U.S. Application Data

- (63) Continuation-in-part of application No. 29/749,871, filed on Sep. 9, 2020.
- (51) **LOC (14) Cl.** **14-03**
- (52) **U.S. Cl.**
USPC **D14/218**
- (58) **Field of Classification Search**
USPC D11/26, 29, 34, 37, 38, 1; D14/156, 218, D14/430; D21/333
CPC G08B 21/02; G08B 25/009; G08B 25/016
See application file for complete search history.

(57) **CLAIM**

The ornamental design for a wireless controller, as shown and described.

DESCRIPTION

FIG. 1 is a front-top-right perspective view of a wireless controller showing my new design;
FIG. 2 is a front-bottom-left perspective view thereof;
FIG. 3 is a front elevational view thereof;
FIG. 4 is a rear elevational view thereof;
FIG. 5 is a top plan view thereof;
FIG. 6 is a bottom view thereof;
FIG. 7 is a right-side elevational view thereof; and,
FIG. 8 is a left-side elevational view thereof.
The broken lines shown in FIG. 2 depict portions of the wireless controller that form no part of the claimed design.

1 Claim, 8 Drawing Sheets

(56) **References Cited**

U.S. PATENT DOCUMENTS

5,832,296 A *	11/1998	Wang	G06F 21/35
				340/539.22
6,297,808 B1 *	10/2001	Yang	G06F 3/041
				345/167
D547,304 S *	7/2007	Francz	D14/218
8,570,273 B1 *	10/2013	Smith	G06F 3/03547
				345/161
D706,438 S *	6/2014	Hahr	D24/215
D750,521 S *	3/2016	Poesel	D10/104.1
D844,599 S *	4/2019	Stipancik	D14/344

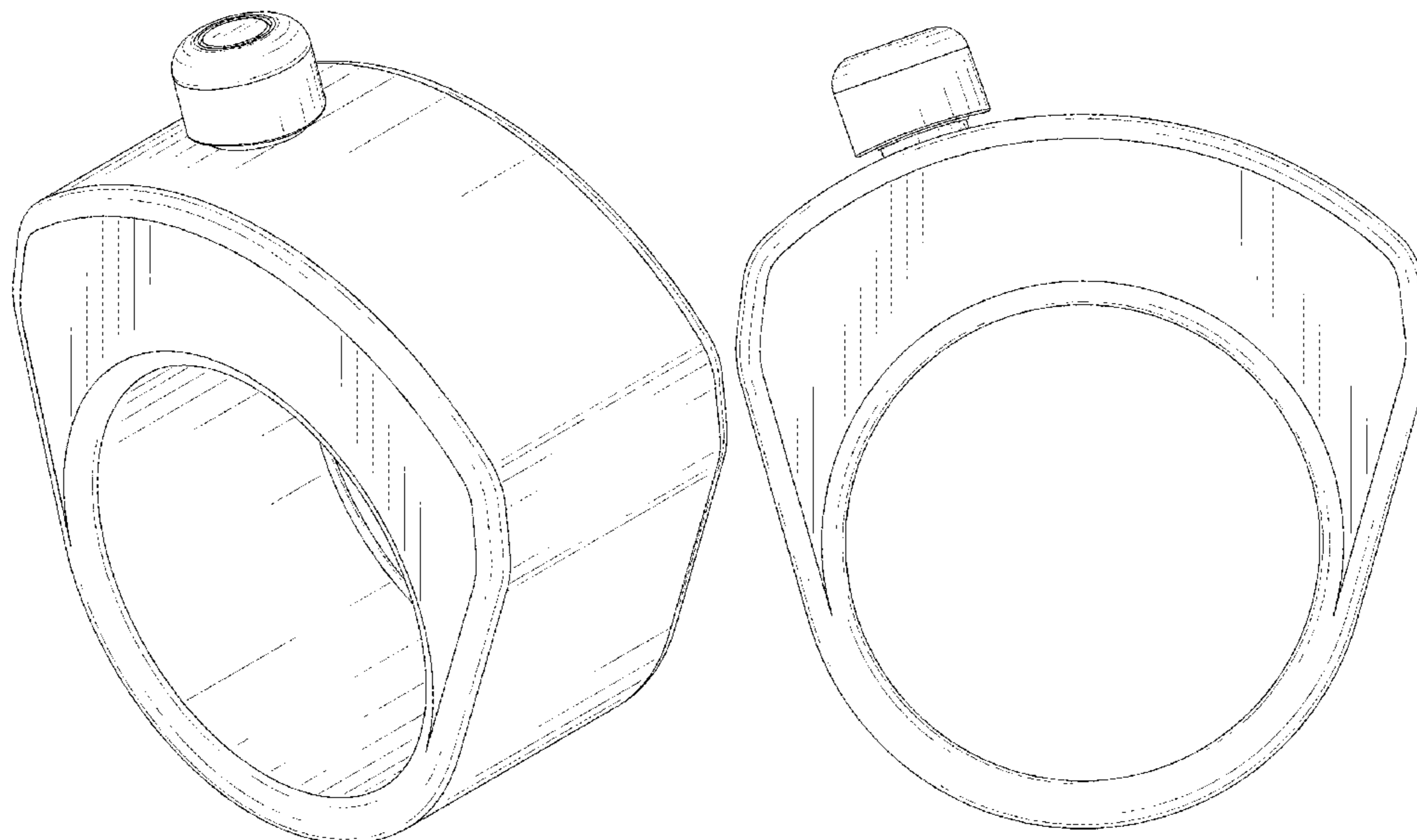

(56)

References Cited

OTHER PUBLICATIONS

ArcX Sport, first available Apr. 21, 2021 [online], [retrieved Jun. 15, 2022]. Available from the Internet, URL:<<https://www.geeky-gadgets.com/fitness-smart-ring-21-04-2021/>>. (Year: 2021).*

* cited by examiner

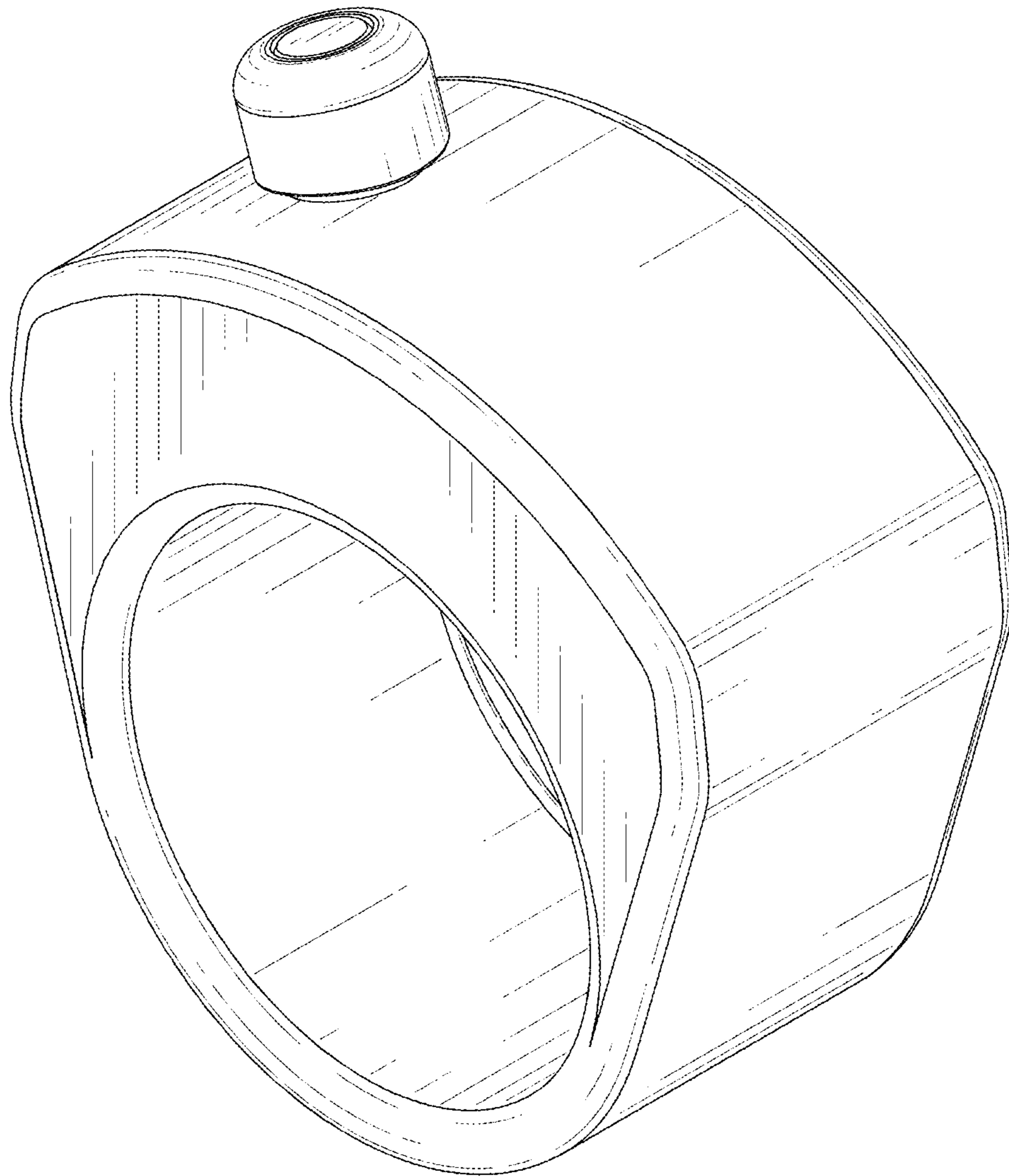

FIG .1

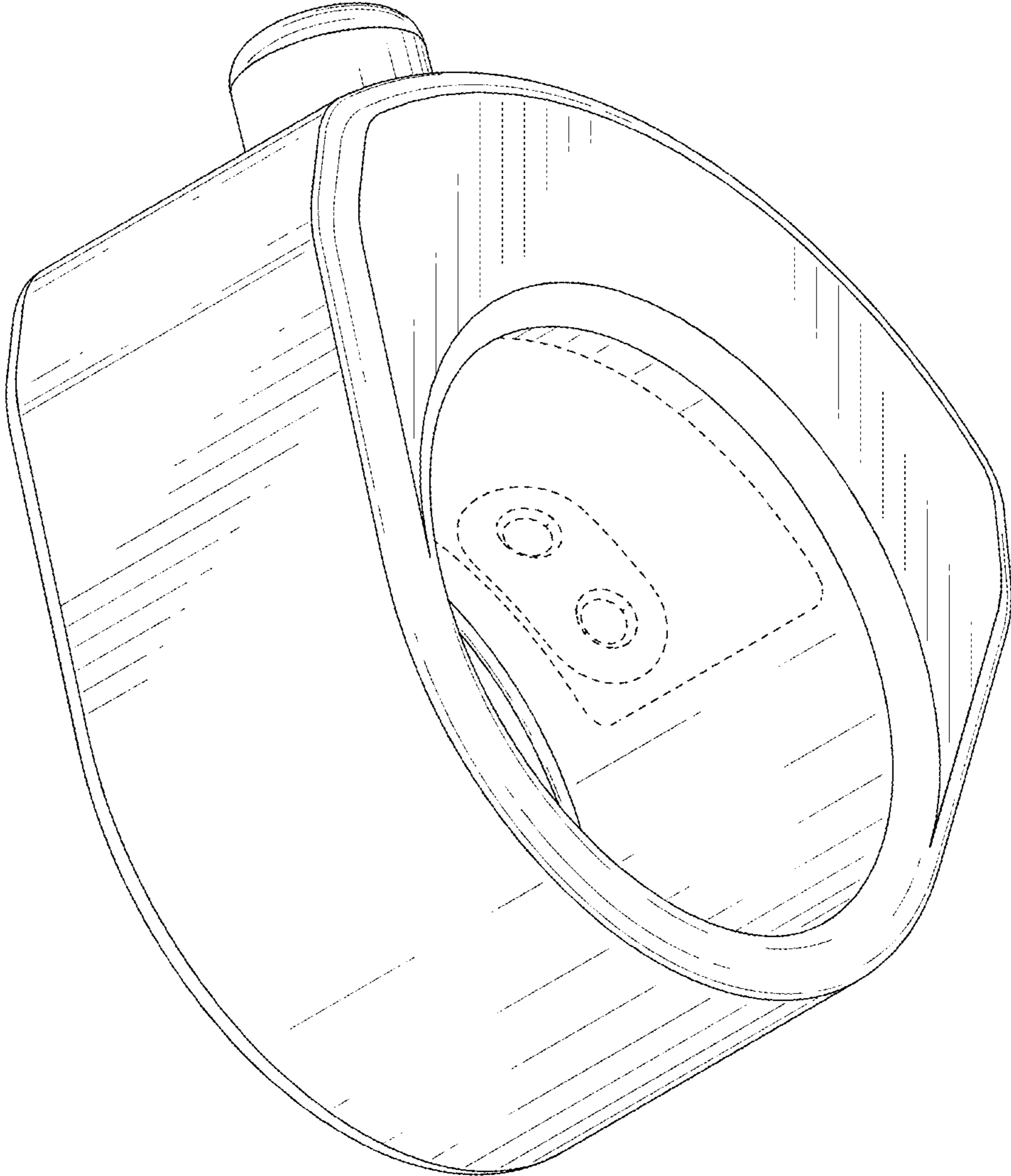

FIG .2

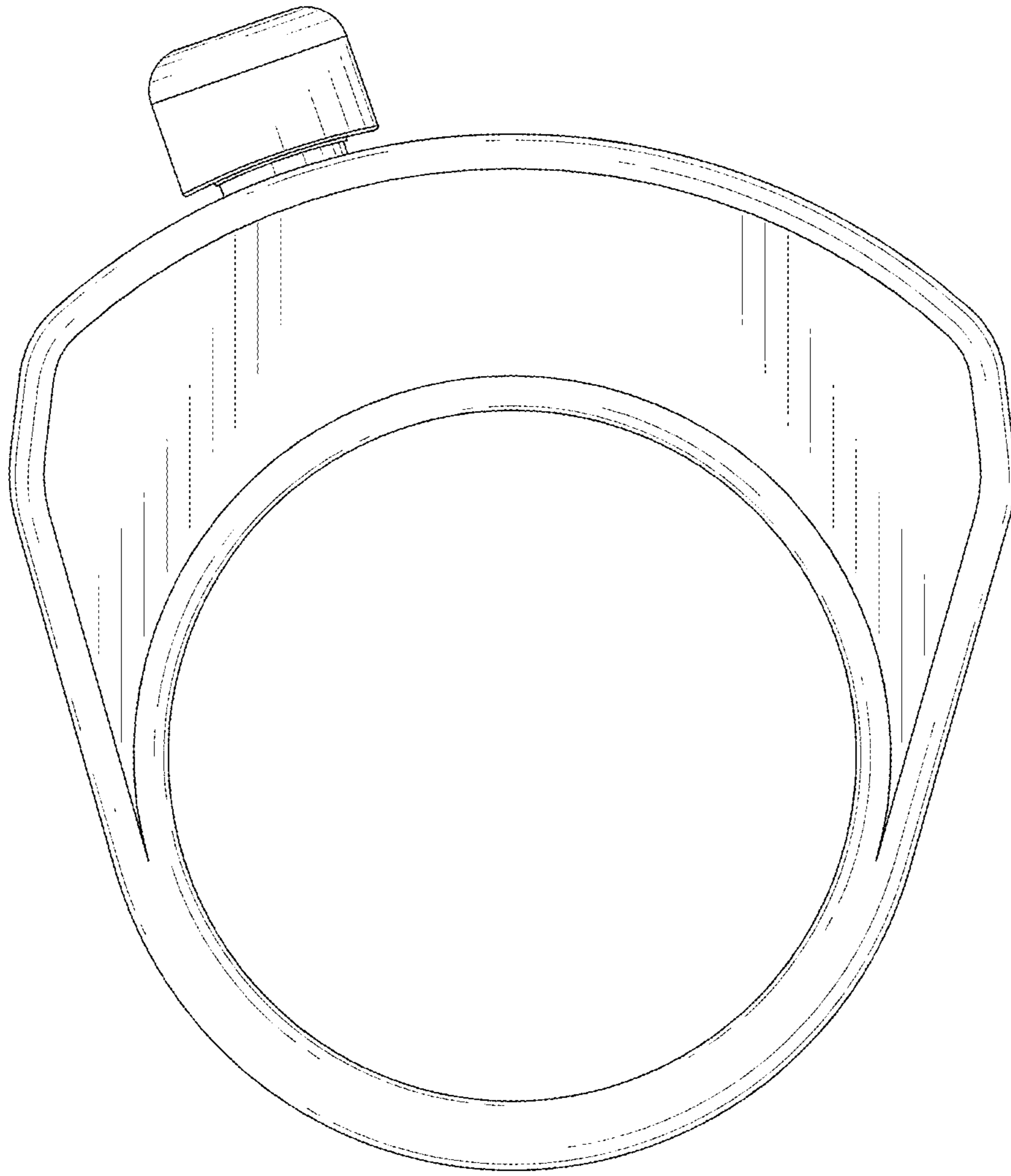

FIG .3

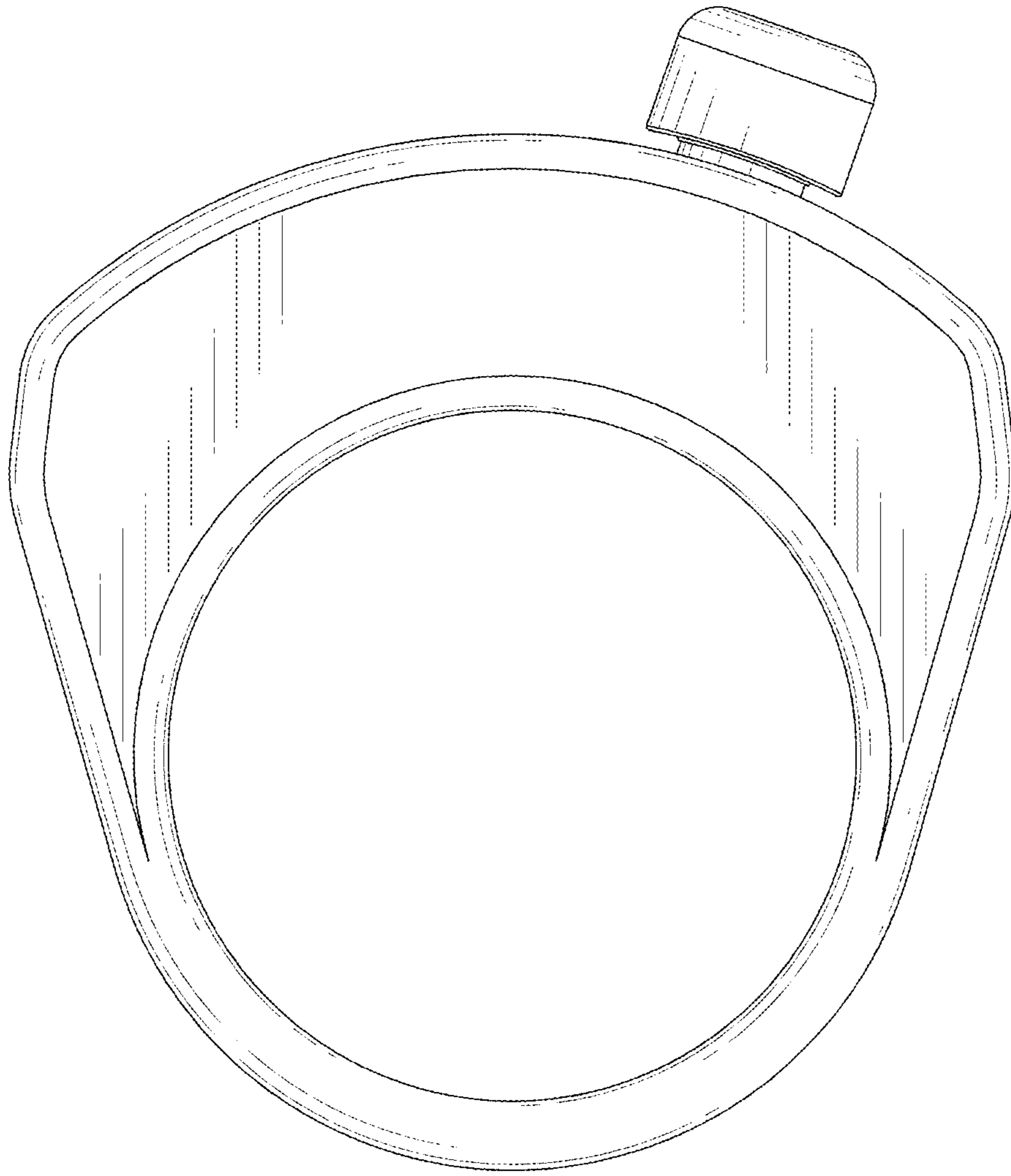

FIG .4

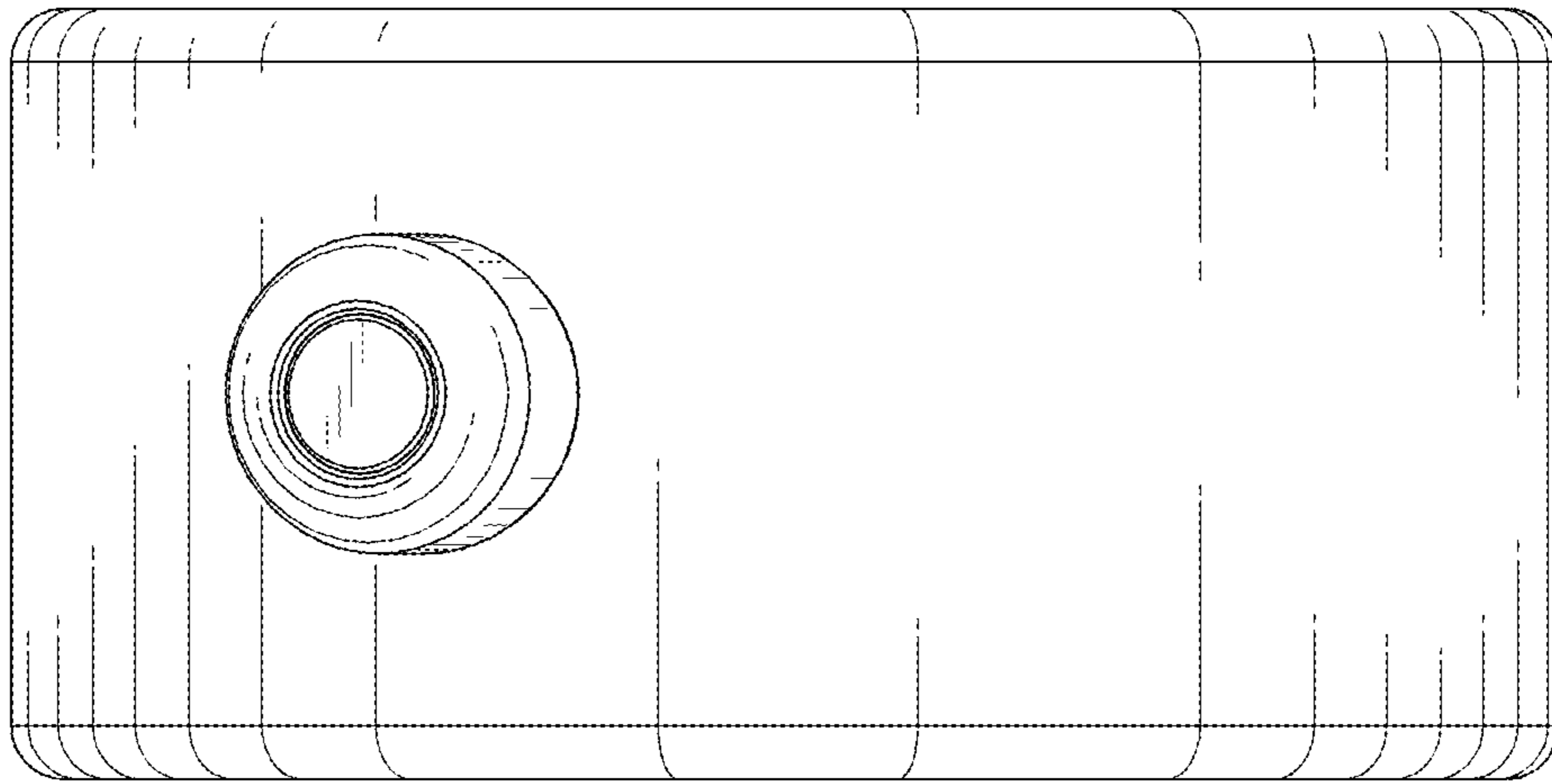

FIG .5

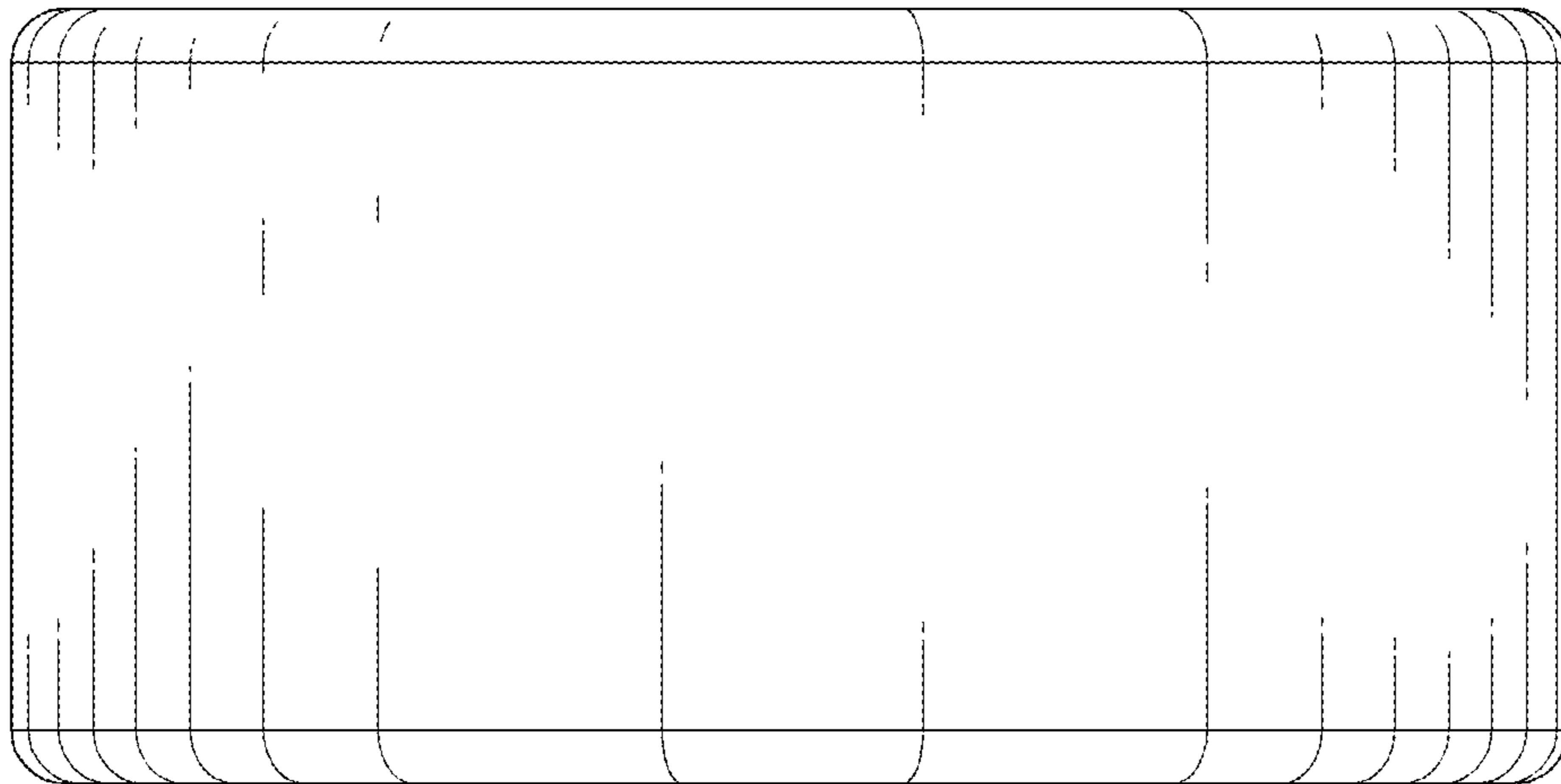

FIG .6

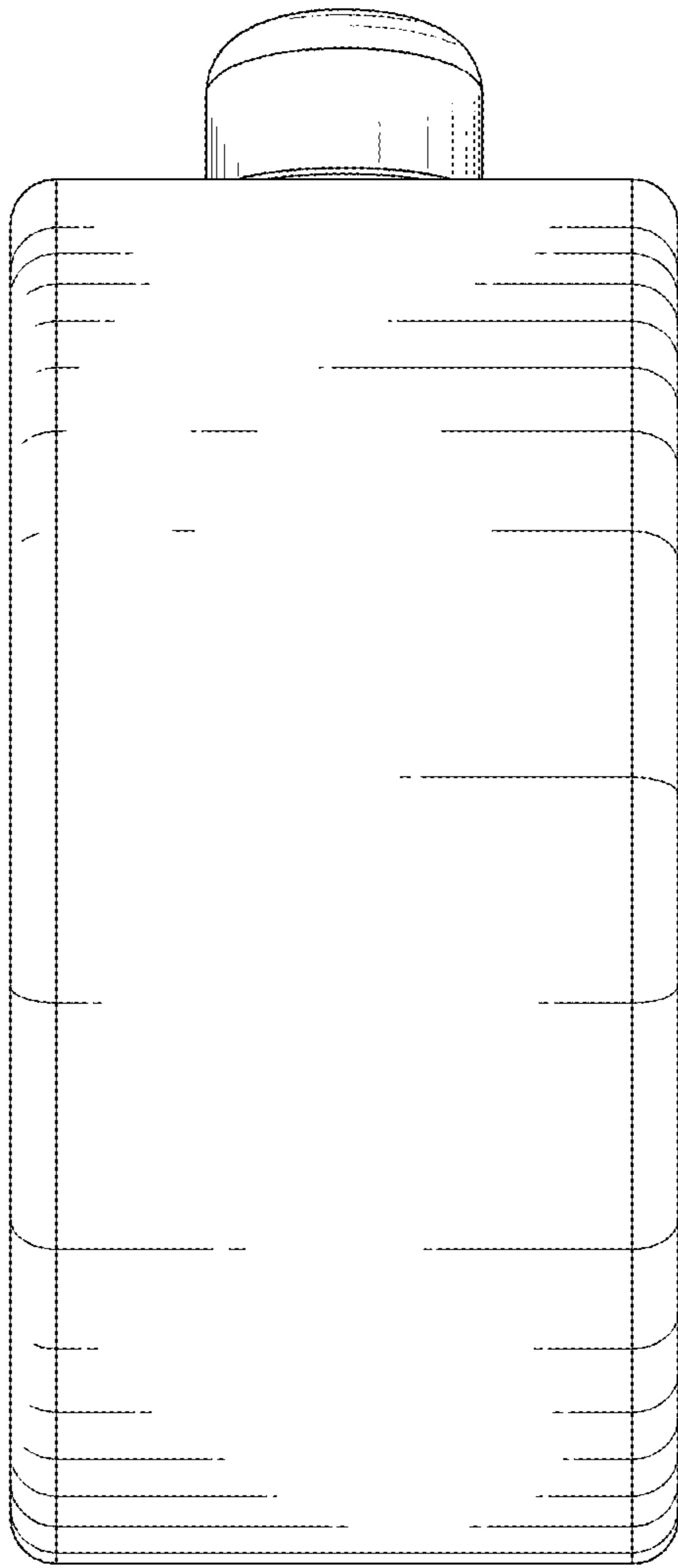

FIG .7

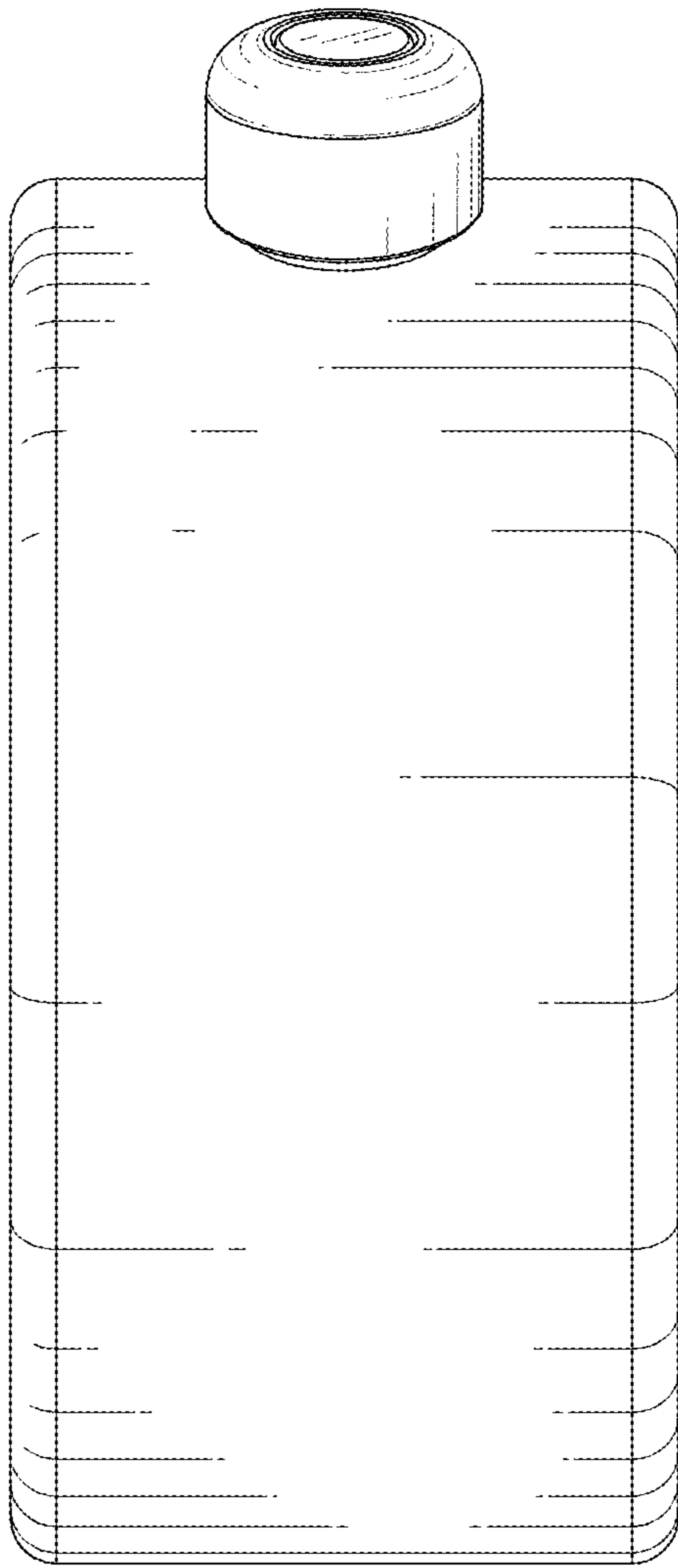

FIG .8