

US00D978700S

(12) **United States Design Patent** (10) **Patent No.:** **US D978,700 S**
Ogura et al. (45) **Date of Patent:** **** *Feb. 21, 2023**

(54) **OPERATING PANEL FOR ELEVATOR**
(71) Applicant: **Mitsubishi Electric Corporation,**
Tokyo (JP)
(72) Inventors: **Toshihisa Ogura,** Tokyo (JP);
Yoshinori Saikawa, Tokyo (JP)
(73) Assignee: **Mitsubishi Electric Corporation,**
Tokyo (JP)
(*) Notice: This patent is subject to a terminal dis-
claimer.
(**) Term: **15 Years**

D438,237 S * 2/2001 Chu D18/7
D483,796 S * 12/2003 Hsu D18/7
D596,977 S * 7/2009 Ogura D10/108
D674,352 S * 1/2013 Saikawa D13/164
D679,210 S * 4/2013 Saikawa D13/164
D681,493 S * 5/2013 Saikawa D13/164
D696,601 S 12/2013 Saikawa et al.
D696,602 S * 12/2013 Saikawa D13/164
D698,274 S * 1/2014 Saikawa D13/164
D698,686 S * 2/2014 Saikawa D13/164
D699,617 S * 2/2014 Saikawa D13/164
D700,533 S * 3/2014 Saikawa D13/168
D705,687 S * 5/2014 Saikawa D13/164
D705,688 S * 5/2014 Saikawa D13/164
D705,689 S * 5/2014 Saikawa D13/164
D705,723 S * 5/2014 Saikawa D13/164

(Continued)

(21) Appl. No.: **29/753,312**
(22) Filed: **Sep. 30, 2020**
(30) **Foreign Application Priority Data**

Apr. 6, 2020 (JP) 2020-007215 D

(51) **LOC (14) Cl.** **10-05**
(52) **U.S. Cl.**
USPC **D10/108**

(58) **Field of Classification Search**
USPC D10/106.95, 108, 118.2; D13/162, 162.1,
D13/164, 170, 171, 174, 175, 177;
D14/371, 383, 388, 389, 390, 396, 397,
D14/398, 399; D18/6, 7
CPC .. B66B 1/00; B66B 1/466; B66B 3/00; B66B
3/02; B66B 5/00; B66B 7/00; B66B
13/00; B66B 13/30; B66B 13/306; B66B
25/00; B66B 2201/00
See application file for complete search history.

(56) **References Cited**
U.S. PATENT DOCUMENTS

D232,943 S * 9/1974 Nagaokakyo D18/7
D401,268 S * 11/1998 Carels D18/7
D418,820 S * 1/2000 Shintani D13/164

FOREIGN PATENT DOCUMENTS

JP 1434913 S 3/2012

Primary Examiner — Joseph Kukella
Assistant Examiner — Heather A Wencil

(74) *Attorney, Agent, or Firm* — Studebaker & Brackett
PC

(57) **CLAIM**

The ornamental design for an operating panel for elevator, as
shown and described.

DESCRIPTION

FIG. 1 is a perspective view of an operating panel for
elevator, showing our new design;
FIG. 2 is a front view thereof;
FIG. 3 is a rear view thereof;
FIG. 4 is a right side view thereof;
FIG. 5 is a top view thereof;
FIG. 6 is a bottom view thereof;
FIG. 7 is an enlarged cross-sectional view thereof; taken
along line 7-7 of FIG. 2, with the internal system omitted;
and,
FIG. 8 is a reference view showing the state in use.

1 Claim, 8 Drawing Sheets

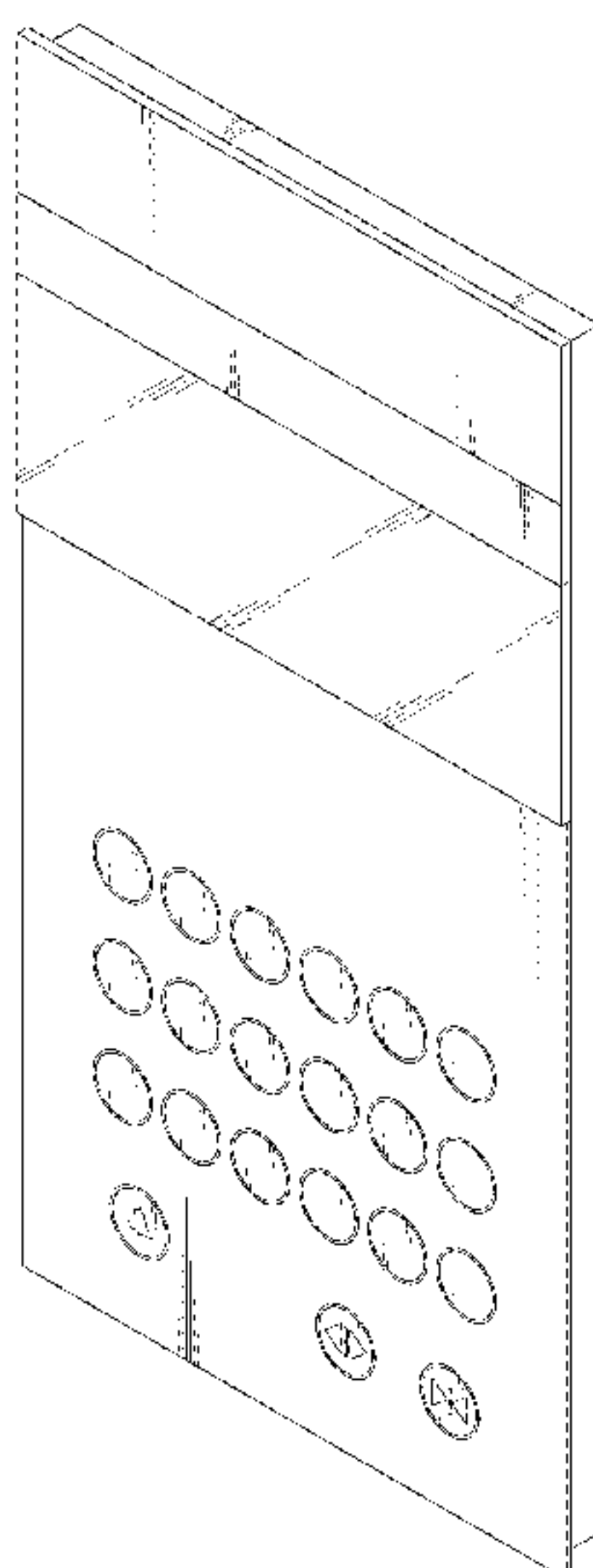

(56)

References Cited

U.S. PATENT DOCUMENTS

D803,815 S * 11/2017 Maier D14/218
D844,613 S * 4/2019 Laurans D14/399

* cited by examiner

Fig. 1

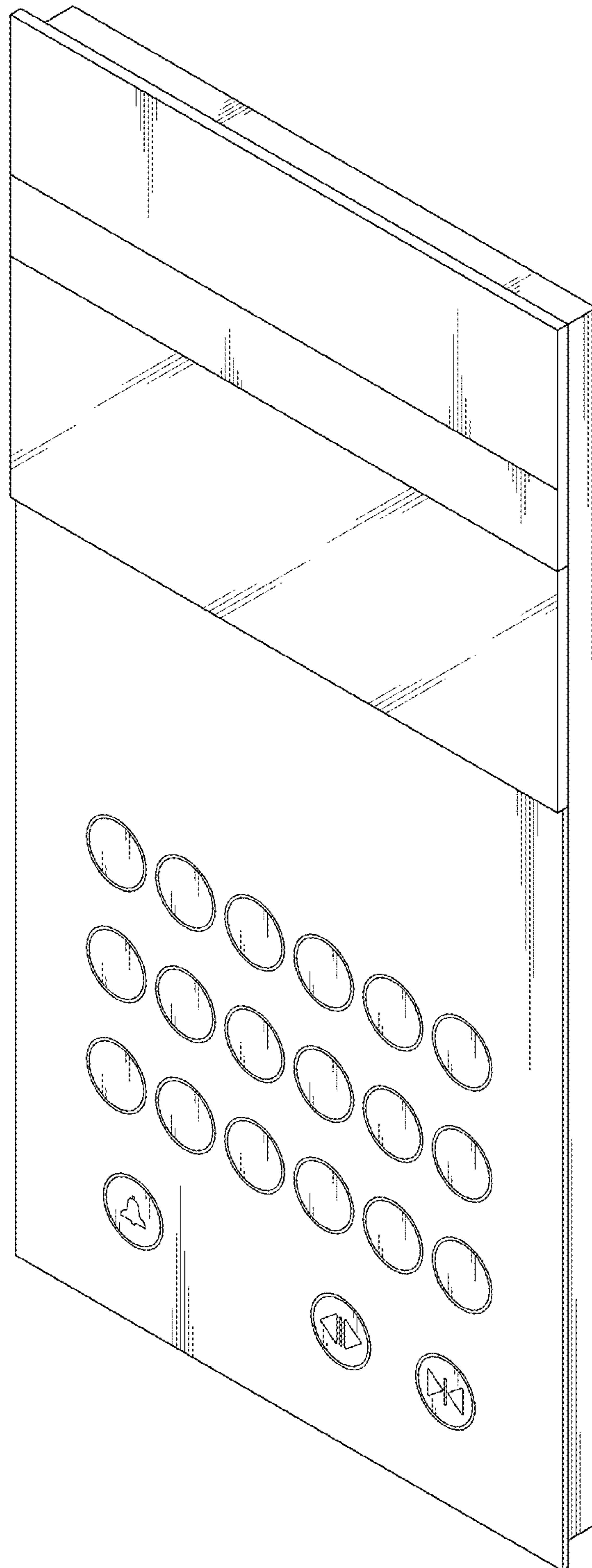

Fig.2

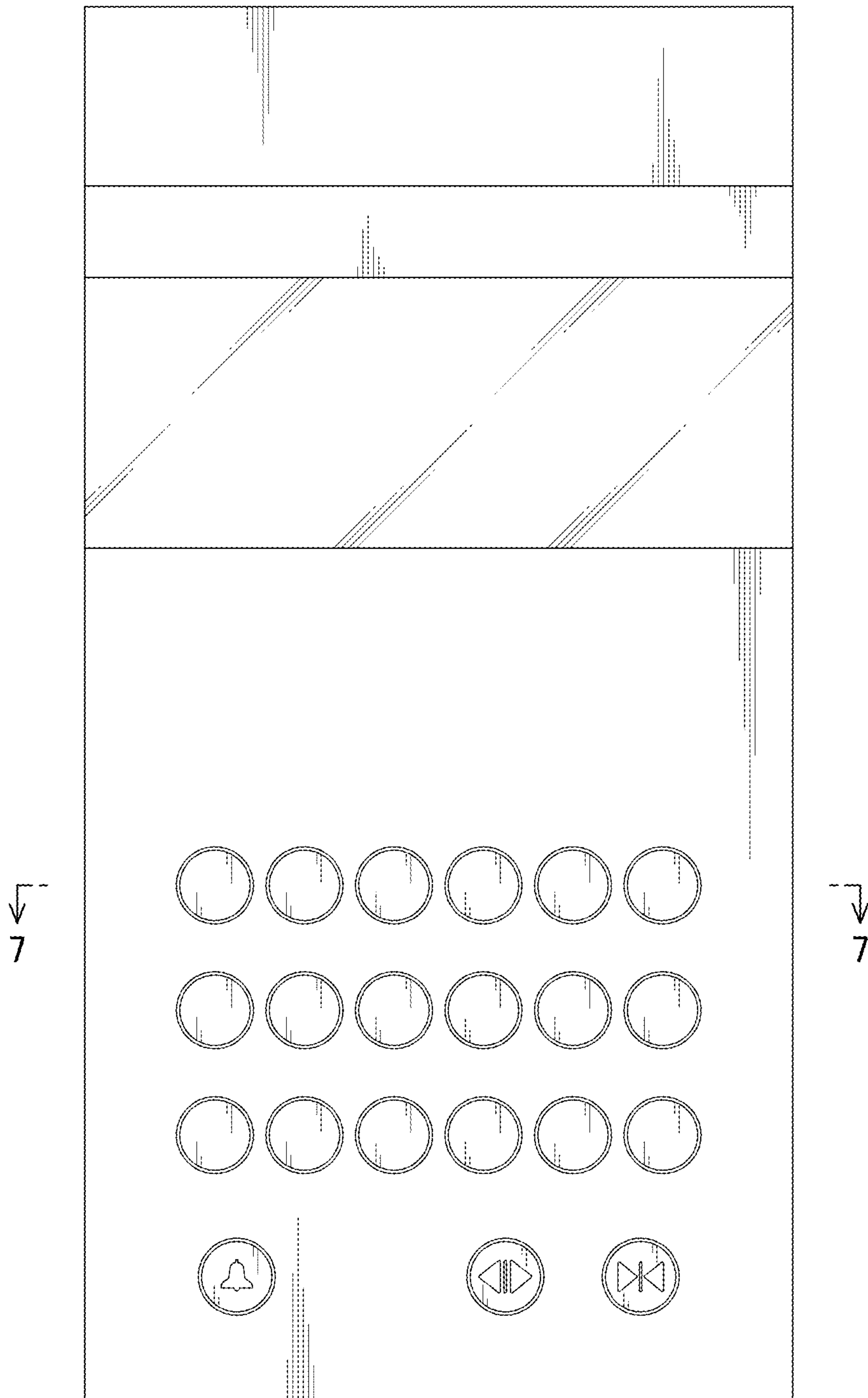

Fig.3

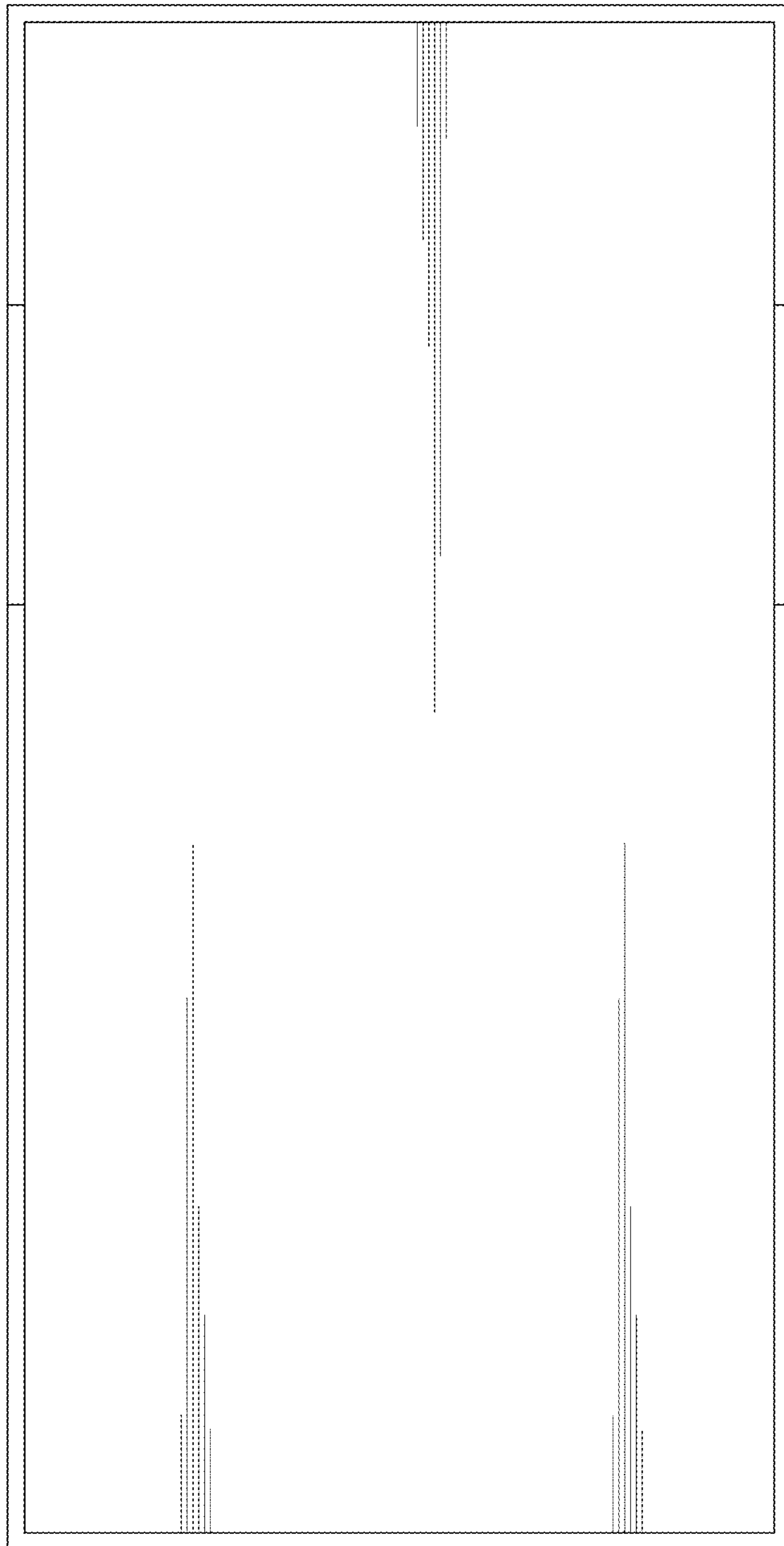

Fig.4



Fig.5

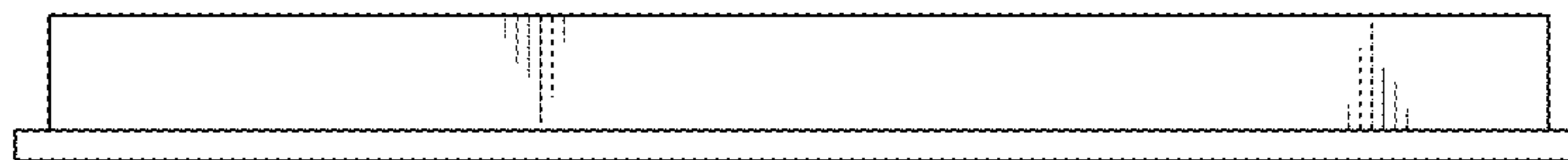

Fig.6

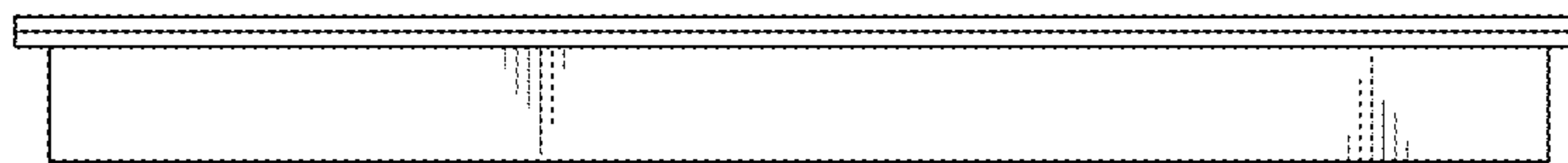

Fig.7

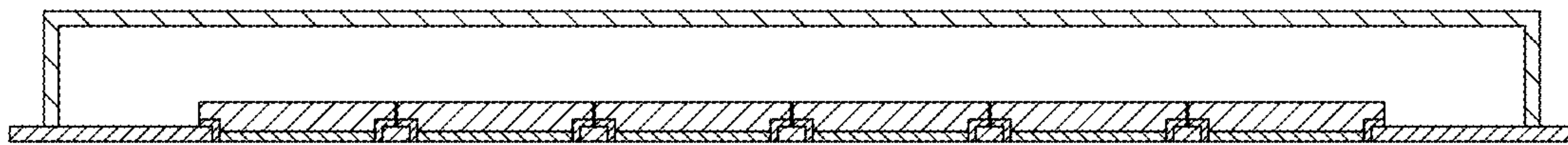

Fig.8

