

US00D978674S

(12) **United States Design Patent** (10) **Patent No.:** **US D978,674 S**
Camilleri et al. (45) **Date of Patent:** **** Feb. 21, 2023**

(54) **CONTAINER**

(71) Applicant: **Société des Produits Nestlé S.A.,**
Vevey (CH)

(72) Inventors: **Nicole Camilleri**, Arlington, VA (US);
Ana Defendini, Arlington, VA (US);
Stephen Nowicki, Arlington, VA (US);
Christina Pacala, Arlington, VA (US);
Jason C. Billig, Thornwood, NY (US);
Daniel T. Kim, Washington Township,
NJ (US); **Stuart M. Leslie**, Larchmont,
NY (US); **Martin Geithmann**, Holland,
OH (US)

D602,783 S * 10/2009 Lepoitevin D9/557
D632,182 S * 2/2011 Russell D9/569
D734,672 S * 7/2015 Laupie D9/557
D810,575 S * 2/2018 Jovanovic D9/551
D848,271 S * 5/2019 Galvin D9/542
D900,618 S * 11/2020 Chen D9/570
D904,890 S * 12/2020 Da Barp D9/557
D911,177 S * 2/2021 Da Barp D9/502
D917,294 S * 4/2021 Alima D9/540
D932,301 S * 10/2021 Takaddus D9/516
D932,905 S * 10/2021 Klok D9/557
D944,091 S * 2/2022 Deflorian D9/557

(73) Assignee: **SOCIÉTÉ DES PRODUITS NESTLÉ**
S.A., Vevey (CH)

(**) Term: **15 Years**

(21) Appl. No.: **29/766,331**

(22) Filed: **Jan. 14, 2021**

(51) **LOC (14) Cl.** **09-01**

(52) **U.S. Cl.**

USPC **D9/552; D9/556**

(58) **Field of Classification Search**

USPC D9/434-435, 439, 447, 449, 450, 452,
D9/453, 454, 516, 523-524, 528-531,
D9/541-544, 549-551, 558-560, 563,
D9/565-566, 571-575, 682, 686, 687,
D9/693-694, 715, 719, 556, 552;
D7/300, 300.1, 316, 317, 598; D23/211,
D23/225

CPC ... B65D 1/00; B65D 1/02; B65D 1/12; B65D
1/18; B65D 1/20; B65D 1/0223; B65D
23/00; B65D 21/0237; B65D 2501/0009;
B65D 2501/0081

See application file for complete search history.

(56) **References Cited**

U.S. PATENT DOCUMENTS

D466,023 S * 11/2002 Eickmeier D9/556
D556,581 S * 12/2007 Yamada D9/557

OTHER PUBLICATIONS

Nesquik Syrup 22 Oz Chocolate. Online, published date unknown.
Retrieved on Jul. 7, 2022 from URL: <https://www.walmart.com/ip/Nesquik-Syrup-22-Oz-Chocolate-1-count-only/152789104>.*

* cited by examiner

Primary Examiner — Omeed Agilee

(74) *Attorney, Agent, or Firm* — Finnegan, Henderson,
Farabow, Garrett & Dunner, LLP

(57) **CLAIM**

The ornamental design for a container, as shown and described.

DESCRIPTION

FIG. 1 is a top, rear, right side perspective view of a first embodiment of a container, showing our new design;
FIG. 2 is a front elevation view thereof;
FIG. 3 is a rear elevation view thereof;
FIG. 4 is a right side view thereof;
FIG. 5 is a left side view thereof;
FIG. 6 is a top plan view thereof; and,
FIG. 7 is a bottom plan view thereof.
The dash-dash broken lines shown illustrate portions of the container that form no part of the claimed design.

1 Claim, 7 Drawing Sheets

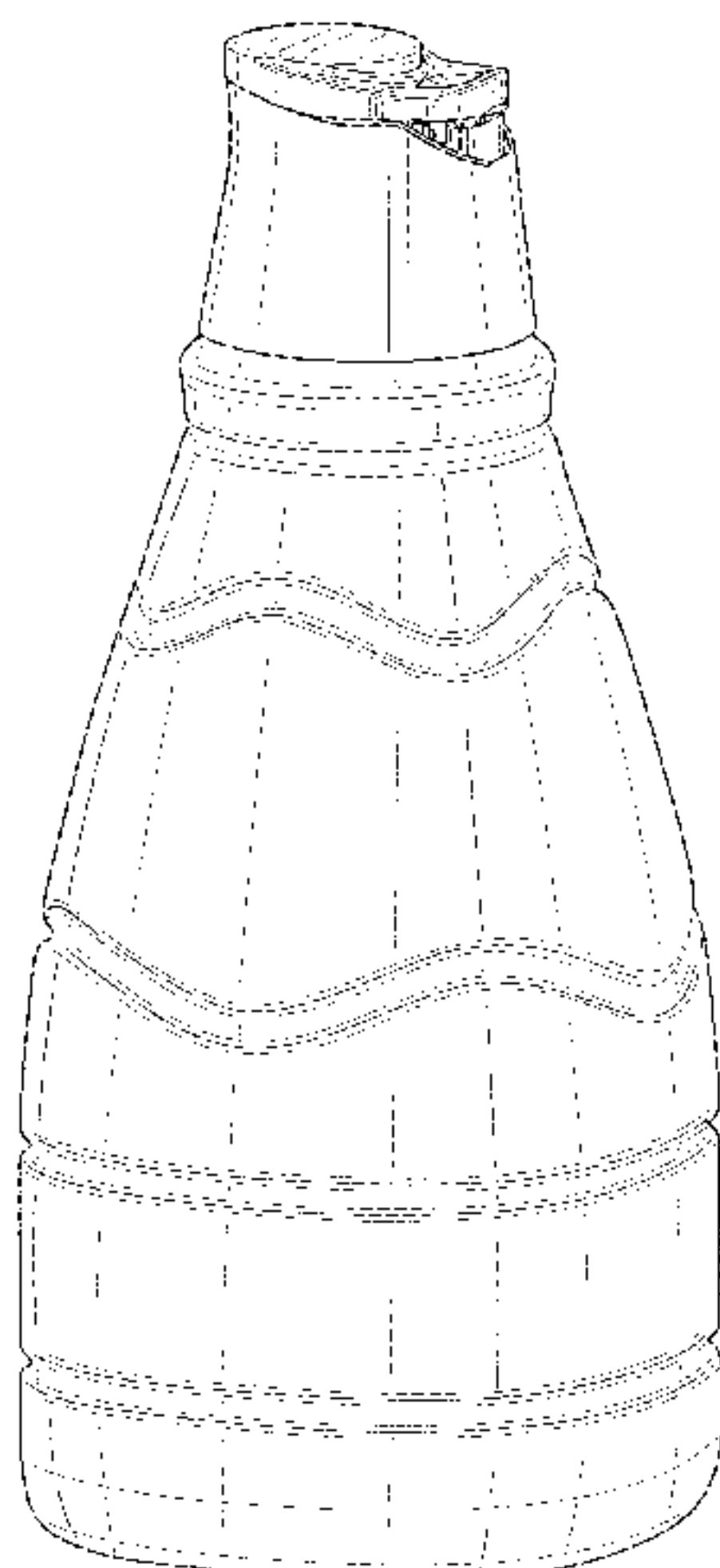

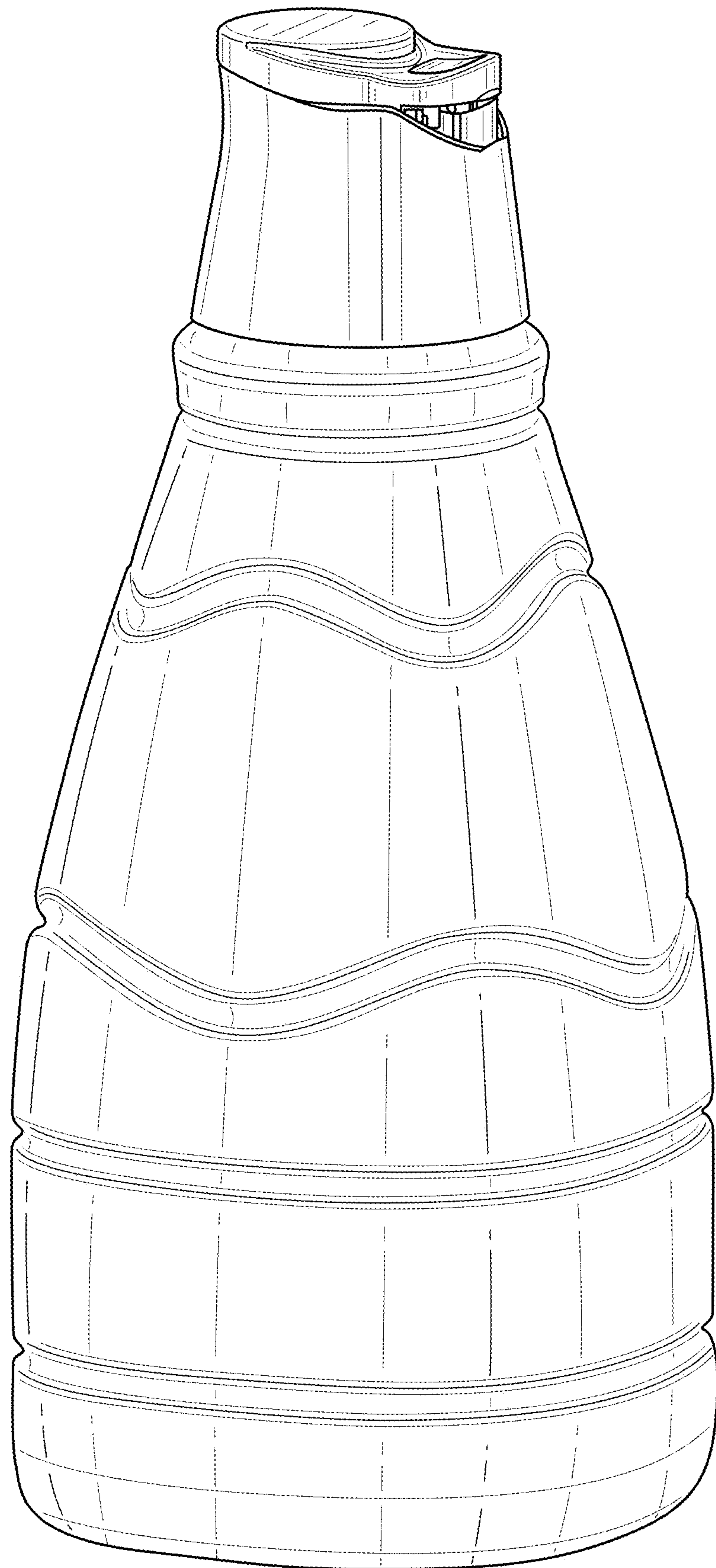

FIG. 1

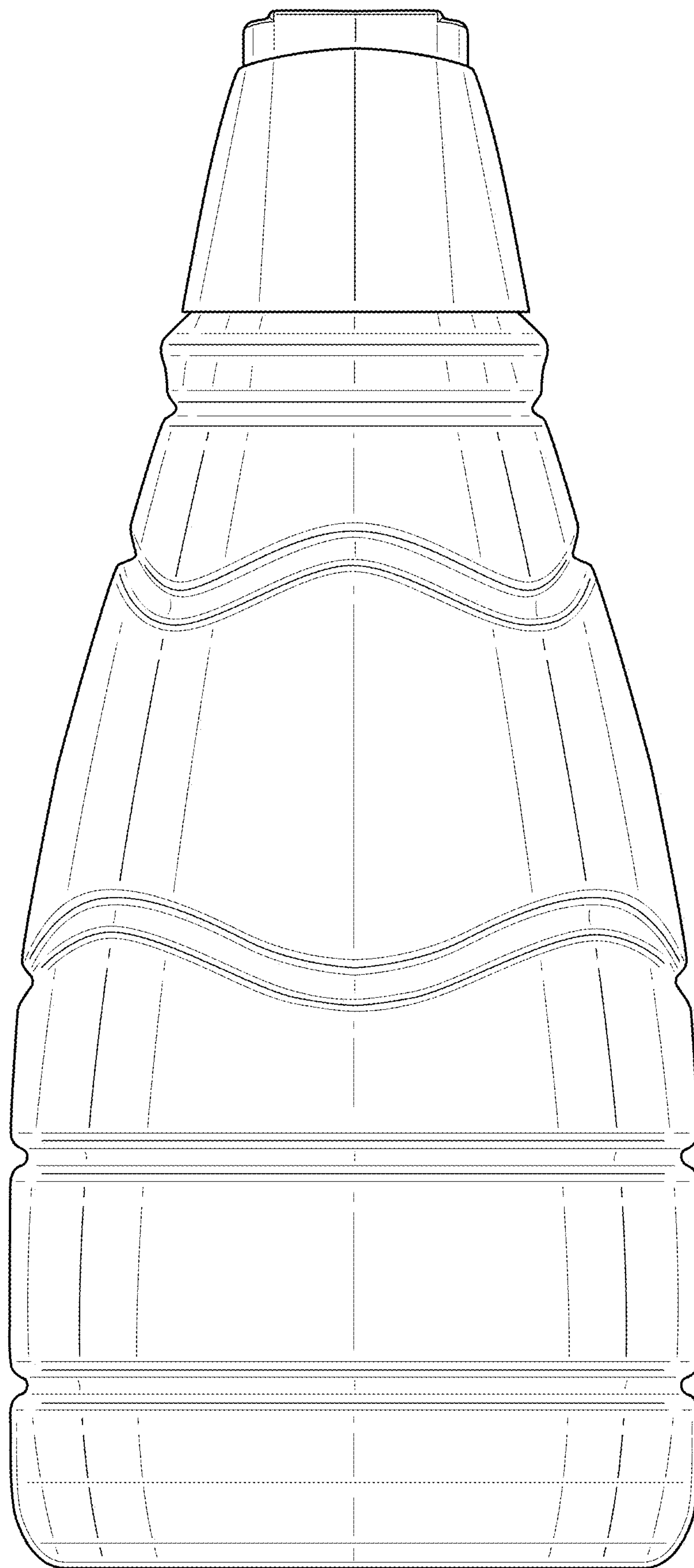

FIG. 2

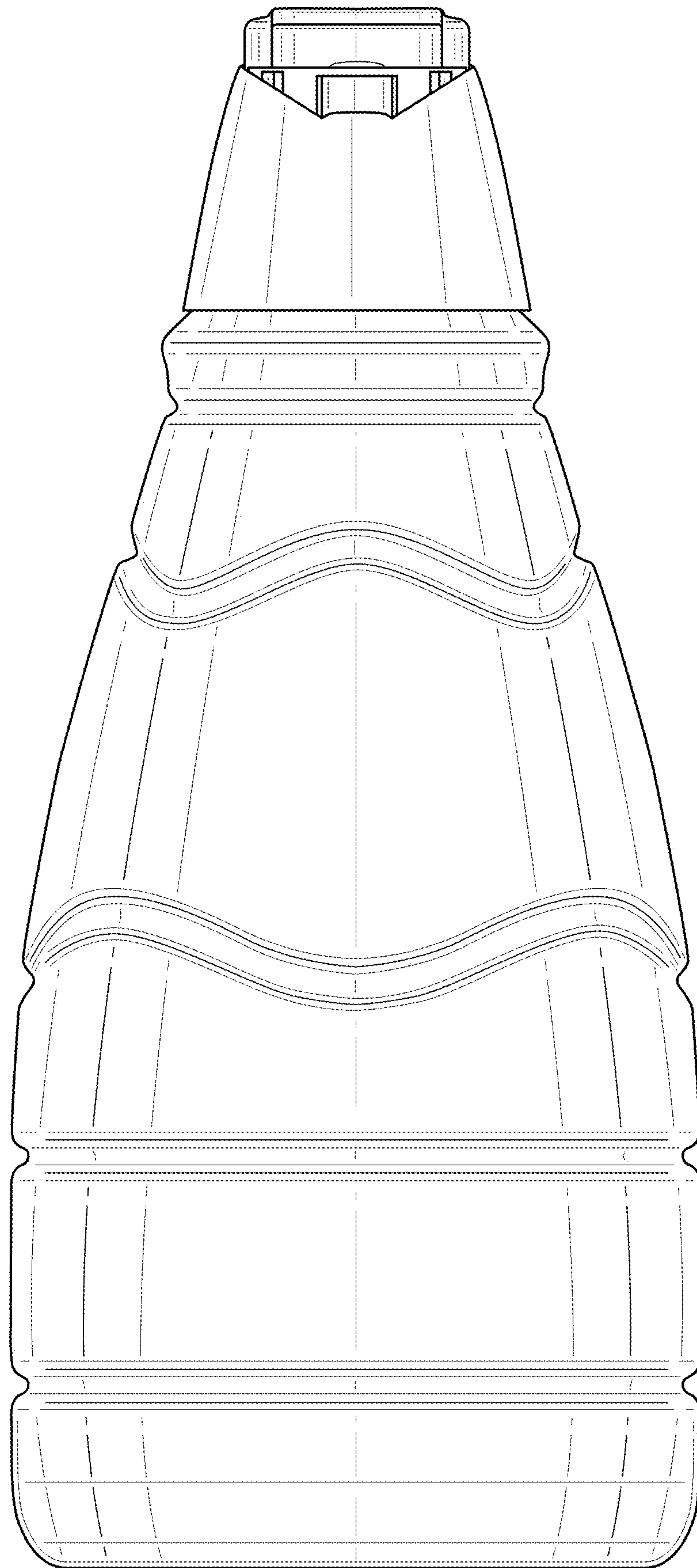

FIG. 3

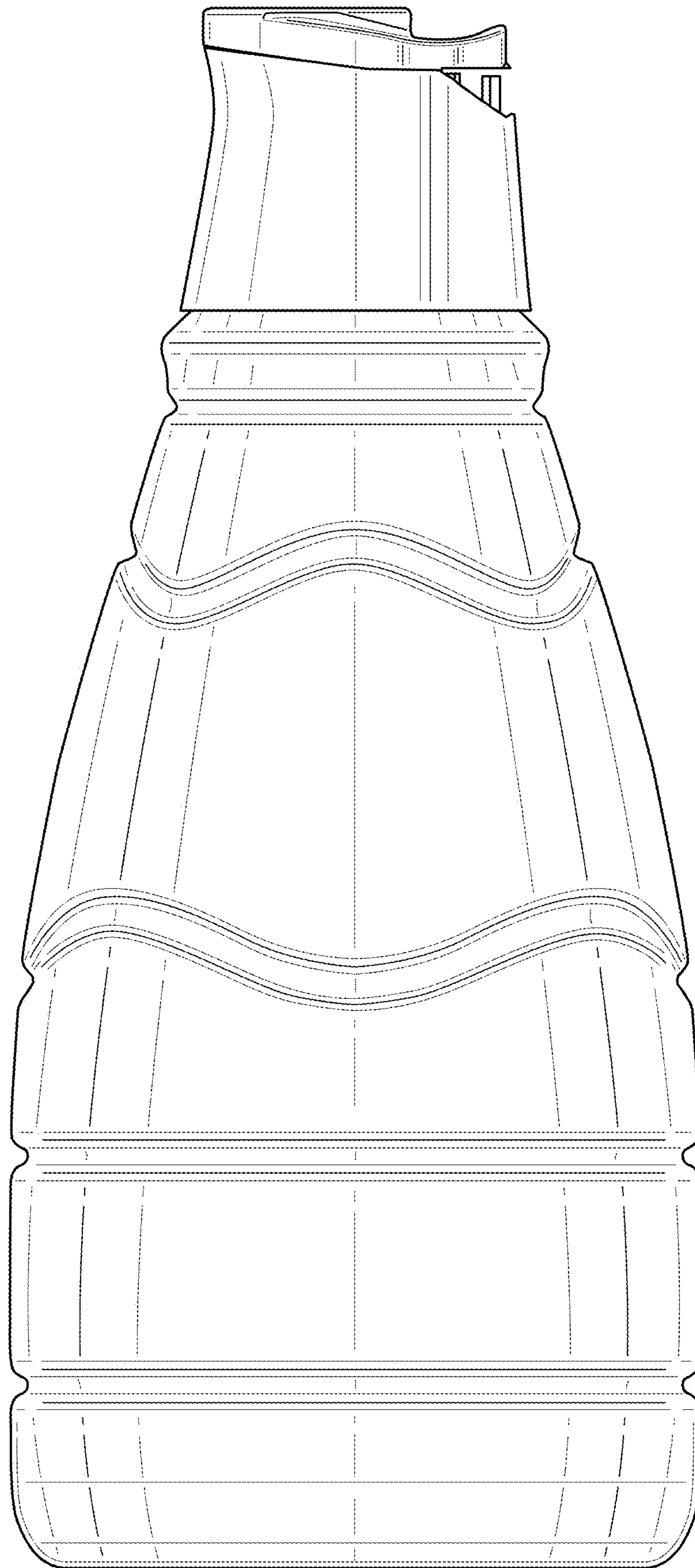

FIG. 4

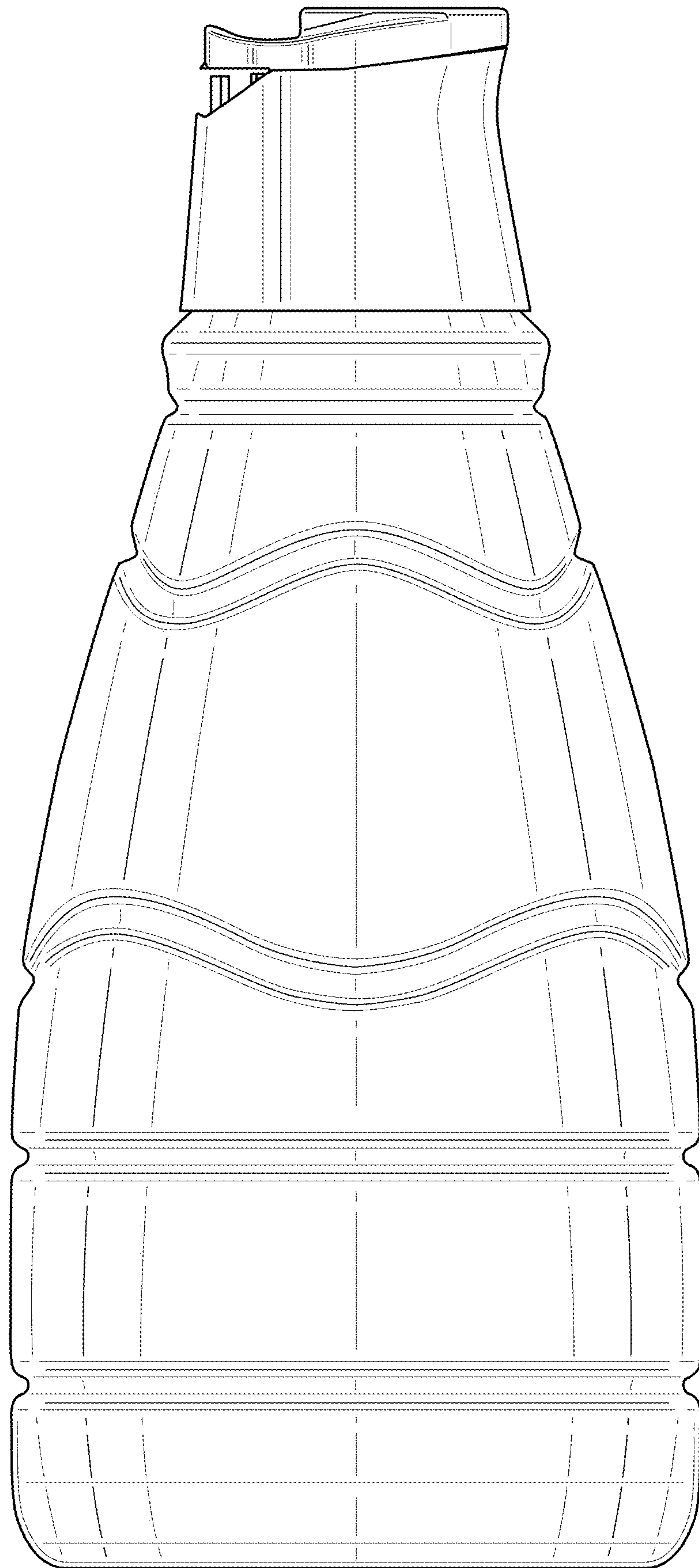

FIG. 5

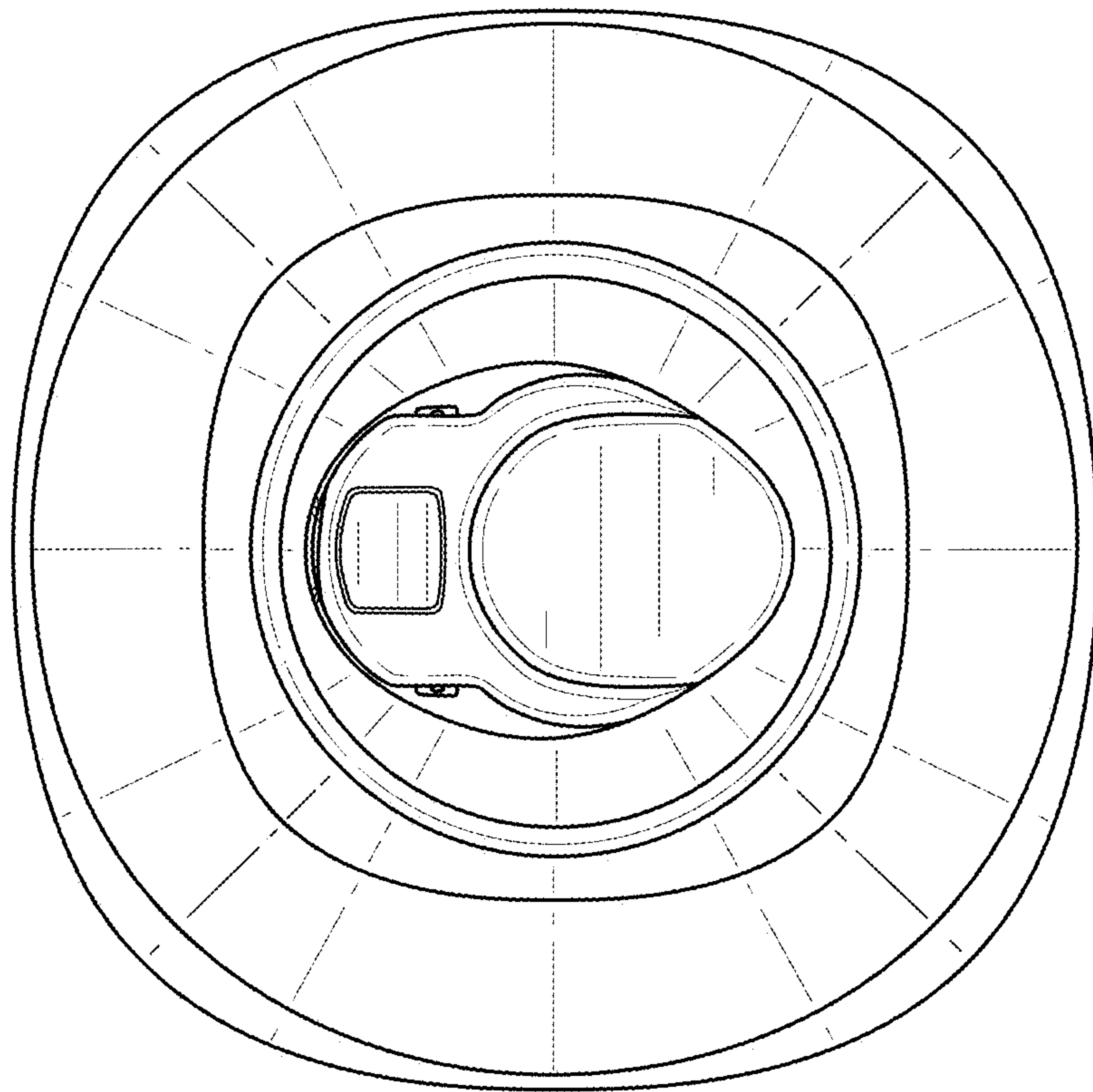

FIG. 6

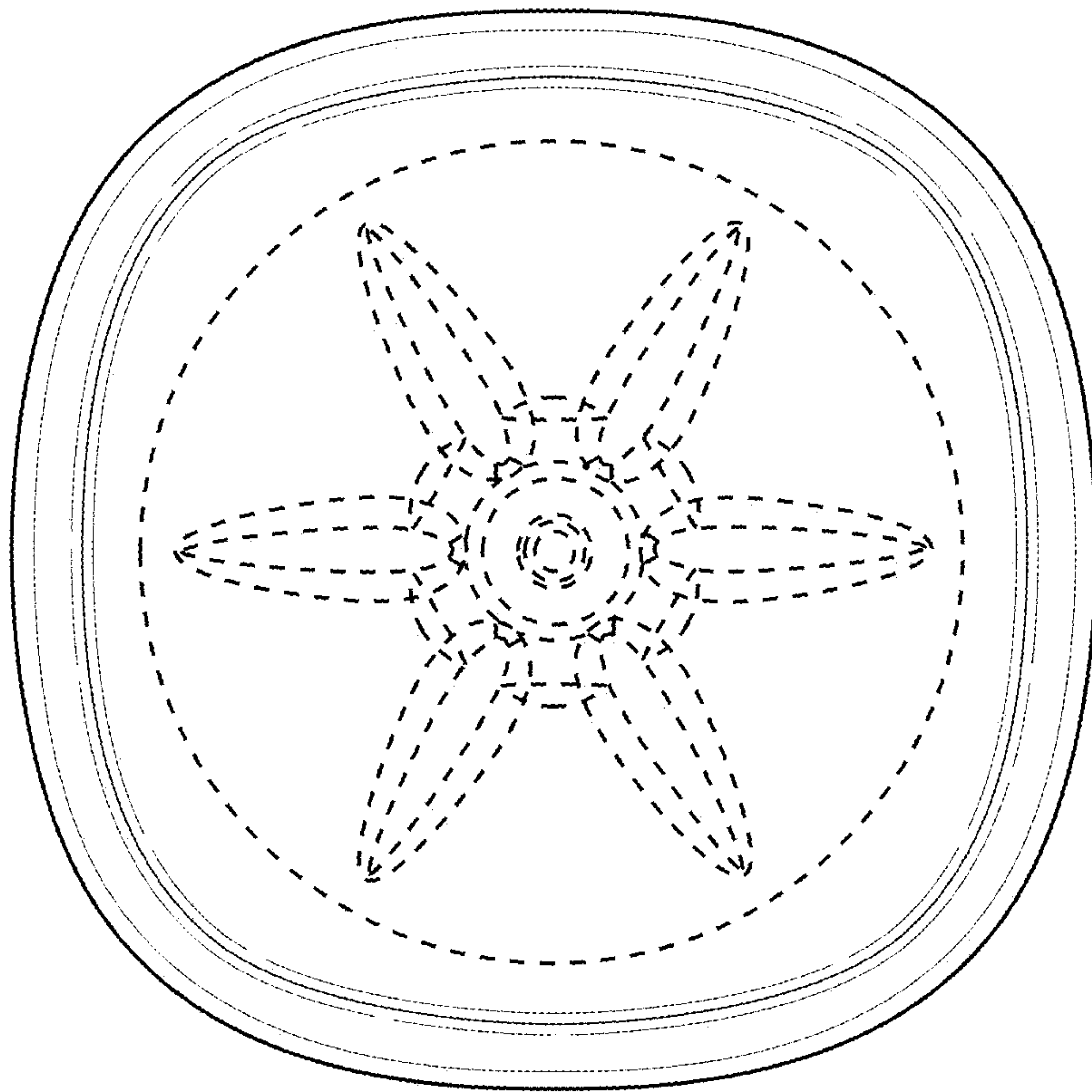

FIG. 7