



US00D978647S

(12) **United States Design Patent**  
**Pech et al.**

(10) **Patent No.:** **US D978,647 S**

(45) **Date of Patent:** **\*\* Feb. 21, 2023**

(54) **PLIERS**

(71) Applicant: **KNIPEX-Werk C. Gustav Putsch KG**,  
Wuppertal (DE)

(72) Inventors: **Martin Pech**, Wuppertal (DE); **Filip Marovic**, Wuppertal (DE); **Jan Schleiminger**, Solingen (DE)

(73) Assignee: **KNIPEX-Werk C. Gustav Putsch KG**,  
Wuppertal (DE)

(\*\*) Term: **15 Years**

(21) Appl. No.: **29/746,342**

(22) Filed: **Aug. 13, 2020**

(30) **Foreign Application Priority Data**

Feb. 14, 2020 (EM) ..... 007695432  
Feb. 25, 2020 (EM) ..... 007715396

(51) **LOC (14) Cl.** ..... **08-05**

(52) **U.S. Cl.**  
USPC ..... **D8/52**

(58) **Field of Classification Search**  
USPC ..... D8/34, 55, 51, 52, 21-26, 75, 105-107;  
D24/107  
CPC ..... B25B 7/02; B25B 25/005; B25B 7/123;  
F15L 33/03; H02G 1/12; H02G 1/1204;  
B25F 1/003; B26B 13/16  
See application file for complete search history.

(56) **References Cited**

**U.S. PATENT DOCUMENTS**

D297,802 S \* 9/1988 Himbert ..... D8/52  
D348,190 S \* 6/1994 Warheit ..... D8/52  
D370,161 S \* 5/1996 Snyder ..... D8/52  
D398,497 S \* 9/1998 Gomas ..... D8/52  
D610,417 S \* 2/2010 Robinson ..... D8/52  
D679,158 S \* 4/2013 Schleiminger ..... D8/52  
D744,306 S \* 12/2015 Peirce ..... D8/52

D775,914 S \* 1/2017 Robinson ..... D8/52  
D803,021 S \* 11/2017 Wu ..... D8/52  
D850,228 S \* 6/2019 Moyer ..... D8/52  
D893,969 S \* 8/2020 Herrmann ..... D8/52  
11,247,308 B2 \* 2/2022 Blumenthal ..... B25B 23/00  
D951,731 S \* 5/2022 Blumenthal ..... D8/52

(Continued)

**FOREIGN PATENT DOCUMENTS**

CN 307147293 \* 3/2022  
EM 007695432-0010 \* 4/2022

**OTHER PUBLICATIONS**

Plier Wrench: Flat, Push Button, 3<sup>3</sup>/<sub>8</sub> in Max Jaw Opening, 16 in Overall Lg, 25 Jaw Positions, Google.com, [online], [site visited Jun. 2, 2022], Available from internet URL: [https://www.grainger.com/product/35HU02?ef\\_id=EA1a1QobChM1g5LR-vyO-AIVMPjBx2w3wTTEAQYCiABEgLphvD\\_BwE:G:s&s\\_kwid](https://www.grainger.com/product/35HU02?ef_id=EA1a1QobChM1g5LR-vyO-AIVMPjBx2w3wTTEAQYCiABEgLphvD_BwE:G:s&s_kwid) (Year: NA).\*

(Continued)

*Primary Examiner* — Michael A. Pratt  
(74) *Attorney, Agent, or Firm* — Collard & Roe, P.C.

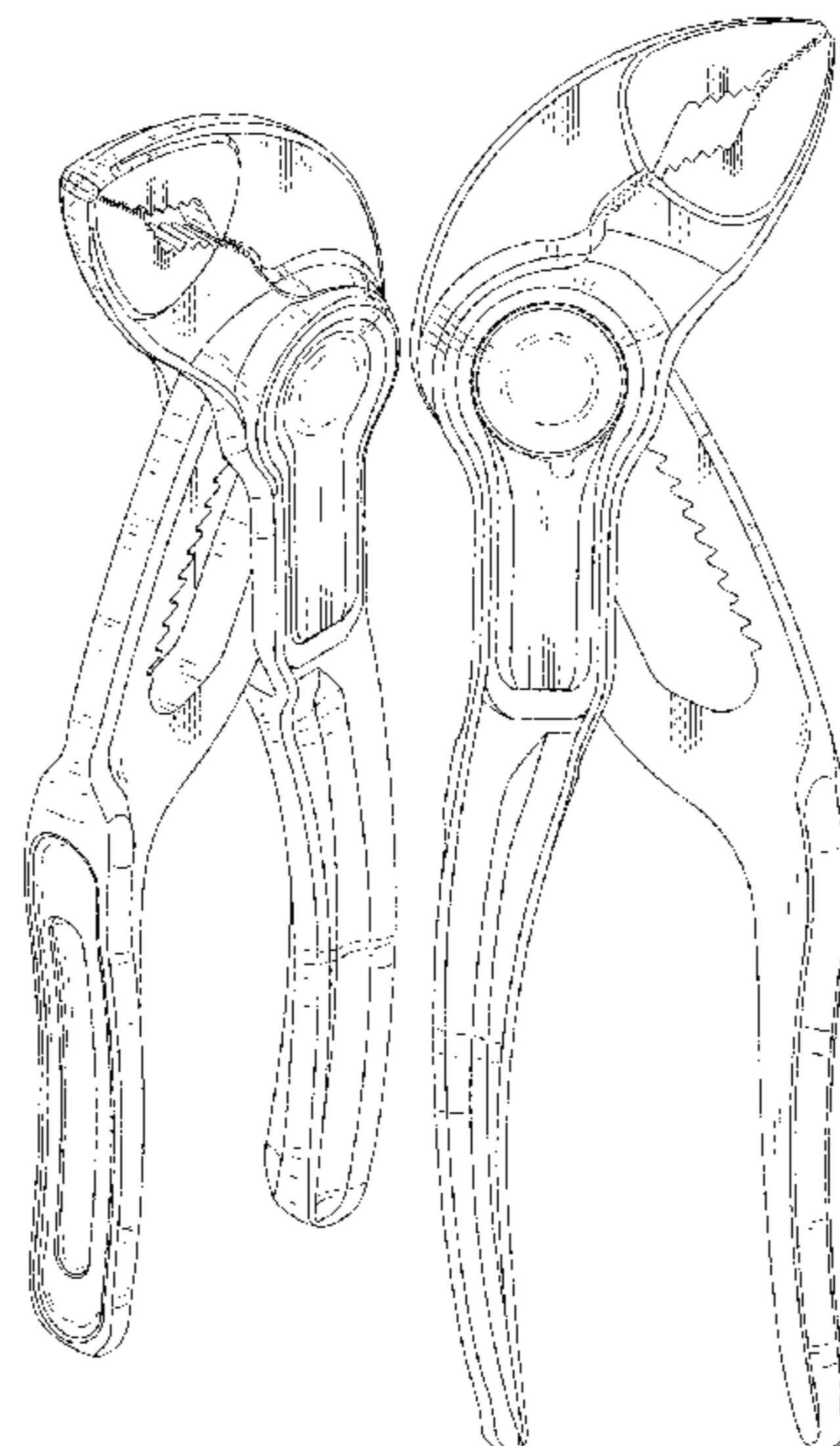
(57) **CLAIM**

The ornamental design for pliers, as shown and described.

**DESCRIPTION**

FIG. 1 is a right side, top and front perspective view of pliers, showing our new design;  
FIG. 2 is a right-side view thereof;  
FIG. 3 is a front view thereof;  
FIG. 4 is a left side view thereof;  
FIG. 5 is a rear view thereof;  
FIG. 6 is a top view thereof;  
FIG. 7 is a bottom view thereof;  
FIG. 8 is a cross-sectional view along lines 8-8 of FIG. 1; and,  
FIG. 9 is a cross-sectional view along lines 9-9 of FIG. 1.

**1 Claim, 9 Drawing Sheets**



(56)

**References Cited**

U.S. PATENT DOCUMENTS

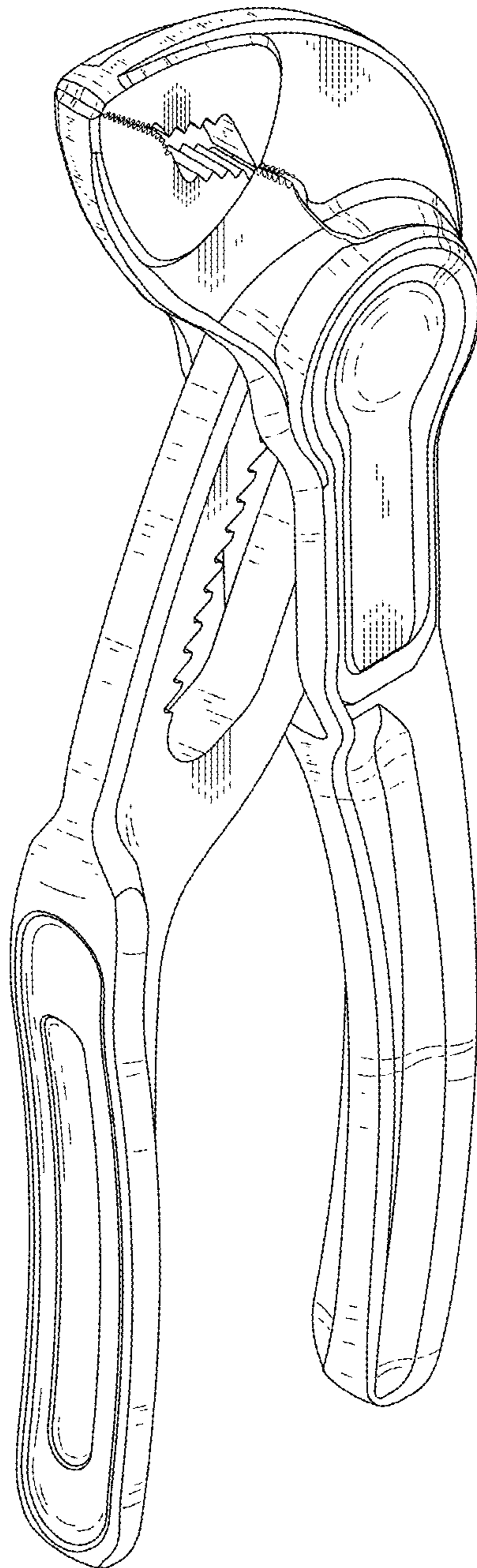
2008/0173143 A1\* 7/2008 Wu ..... B25B 7/123  
81/300  
2008/0196561 A1\* 8/2008 Wu ..... B25B 7/123  
81/329  
2015/0000477 A1\* 1/2015 Wu ..... B25B 7/123  
81/379  
2017/0246731 A1\* 8/2017 Wu ..... B25B 7/123  
2020/0331123 A1\* 10/2020 Wu ..... B25B 7/123

OTHER PUBLICATIONS

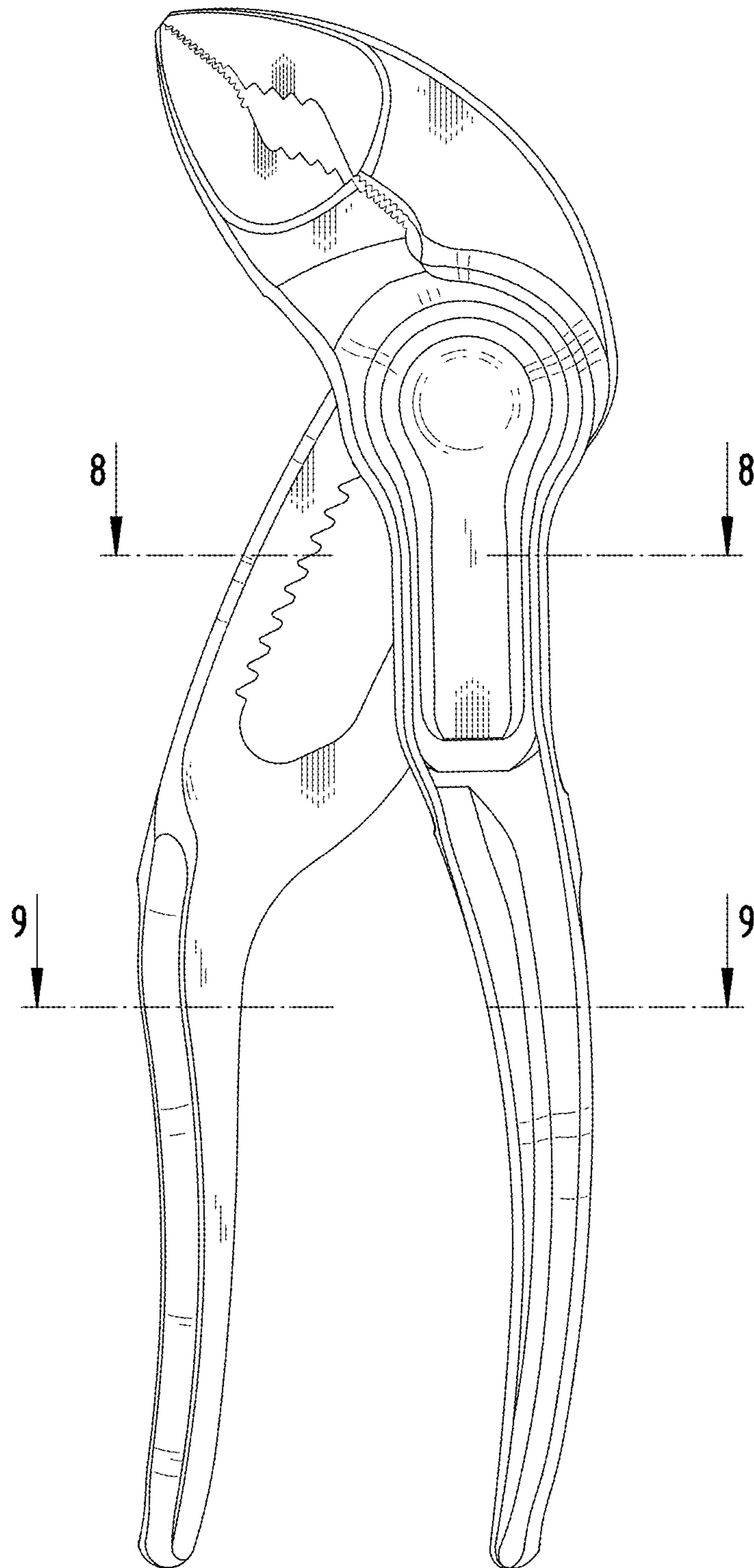
Tongue and Groove Plier: Flat,Groove Joint, 7/8 in Max Jaw  
Opening, , Google.com, [online], [site visited Jun. 2, 2022], Avail-  
able from internet URL: [https://www.grainger.com/product/4CR39?](https://www.grainger.com/product/4CR39?ef_id=EA1a1QobChM1vo385oOP-AIVg7CGCh0O1AglEAQYAyABEgKUJfD_BwE:G:s&s_kwcid)  
ef\_id=EA1a1QobChM1vo385oOP-  
AIVg7CGCh0O1AglEAQYAyABEgKUJfD\_BwE:G:s&s\_kwcid (Year:  
NA).\*

\* cited by examiner

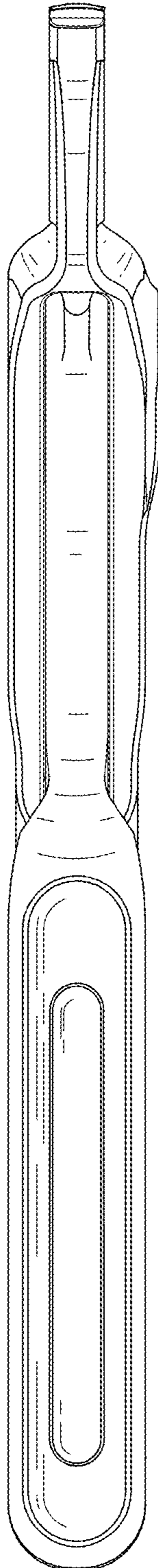
**FIG. 1**



**FIG.2**

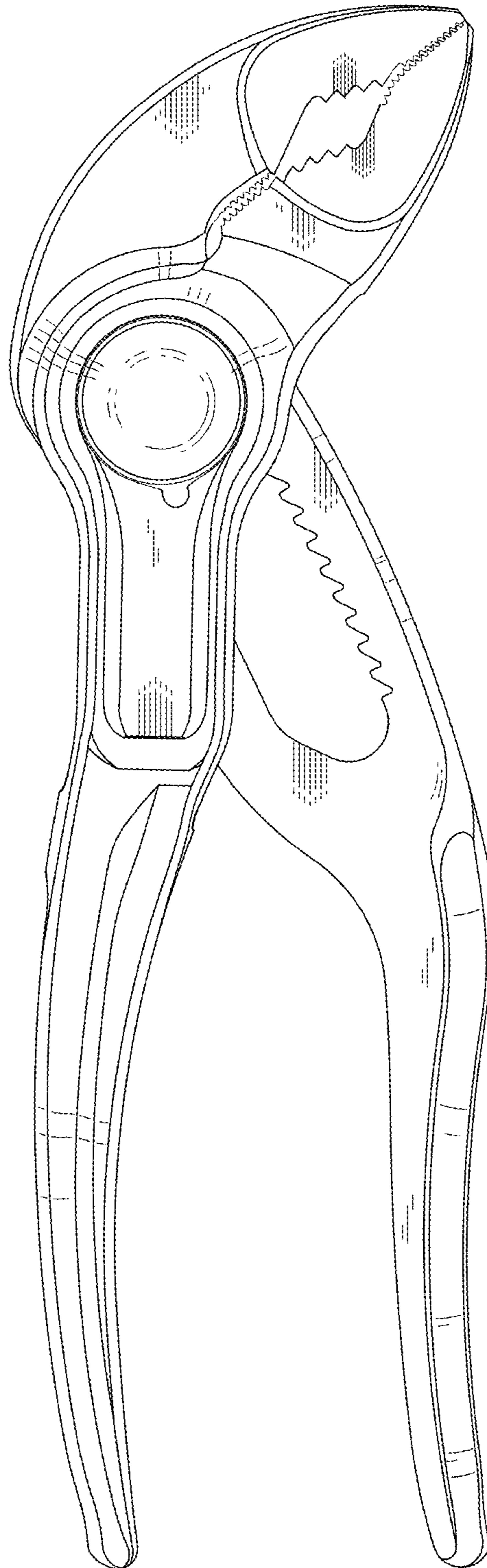


**FIG. 3**

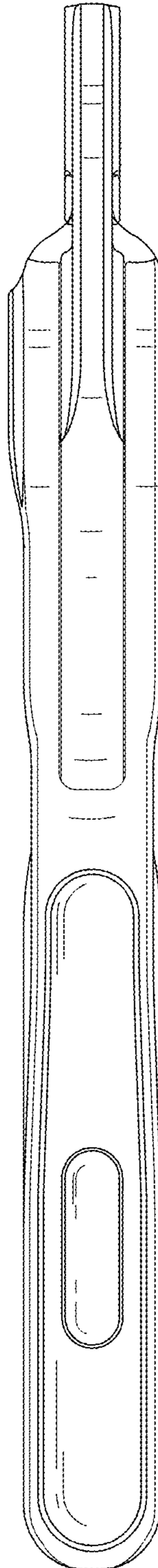




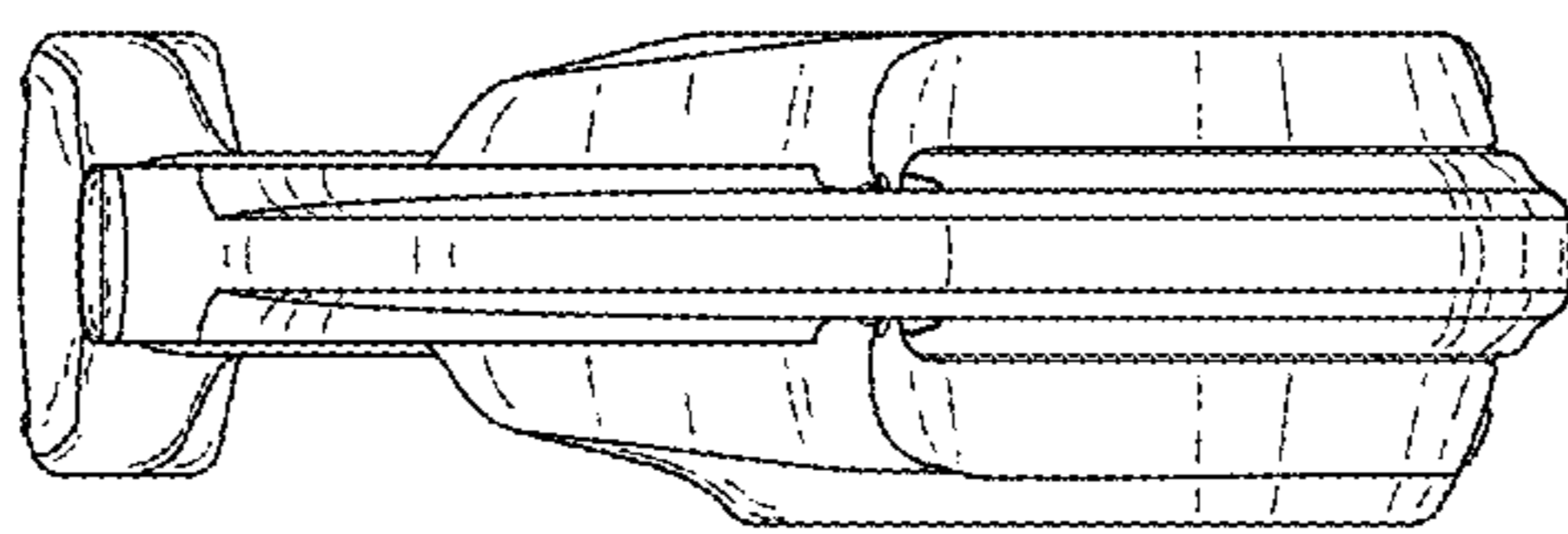
**FIG.4**



**FIG. 5**

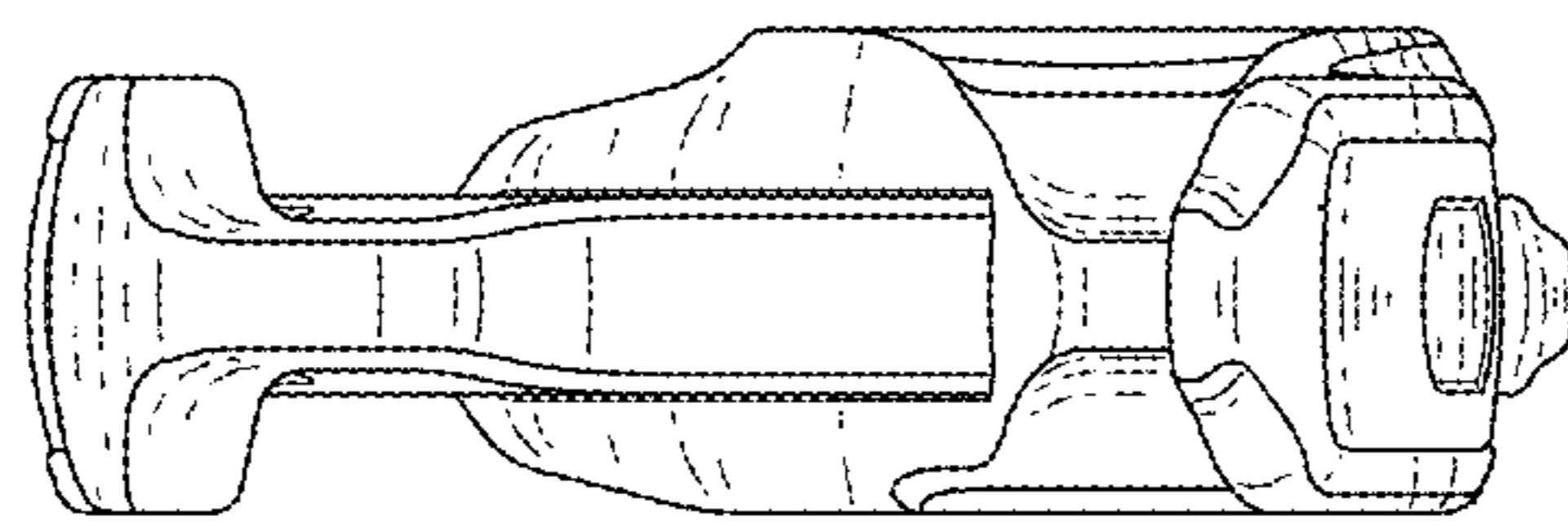


**FIG.6**

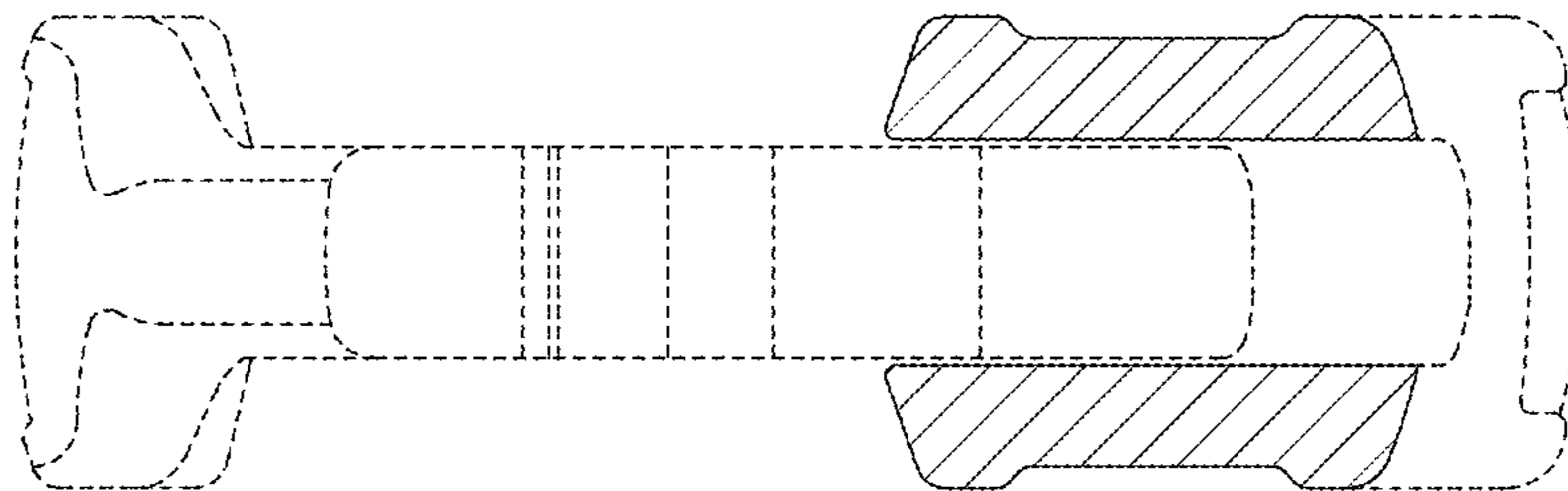




**FIG. 7**



**FIG. 8**



**FIG.9**

