



US00D978575S

(12) **United States Design Patent**  
**Wytas**

(10) **Patent No.:** **US D978,575 S**

(45) **Date of Patent:** **\*\* Feb. 21, 2023**

(54) **PARTIALLY FITTED TOP SHEET FOR A MATTRESS**

(71) Applicant: **Michele Wytas**, East Haddam, CT (US)

(72) Inventor: **Michele Wytas**, East Haddam, CT (US)

(\*\*) Term: **15 Years**

(21) Appl. No.: **29/722,084**

(22) Filed: **Jan. 27, 2020**

(51) **LOC (14) Cl.** ..... **06-13**

(52) **U.S. Cl.**  
USPC ..... **D6/602**

(58) **Field of Classification Search**  
USPC ..... D6/596, 602, 603, 610, 611, 616, 695.1,  
D6/695.3; D7/376, 391  
CPC ..... A45C 13/36; A45C 3/03; A45C 3/001;  
B60R 7/043; B60N 2/60; A47C 31/00  
See application file for complete search history.

(56) **References Cited**

U.S. PATENT DOCUMENTS

- 1,865,329 A \* 6/1932 McHorter ..... A47G 9/02  
5/500
- 2,679,056 A \* 5/1954 Simpson ..... A47G 9/0246  
5/485
- 2,695,414 A \* 11/1954 Ford ..... A47G 9/0246  
5/485
- 3,020,566 A \* 2/1962 Anderson ..... A47G 9/0246  
5/497
- 3,181,179 A \* 5/1965 Roddey, Jr. .... A47C 21/022  
5/497
- 3,962,739 A \* 6/1976 Crockett ..... A47G 9/02  
5/497
- 4,266,308 A \* 5/1981 Shatz ..... A47G 9/02  
5/494
- 4,308,626 A \* 1/1982 Weiss ..... A47G 9/0246  
5/485
- 4,316,299 A \* 2/1982 Friedman ..... A47G 9/02  
5/485

- 4,964,184 A \* 10/1990 Lewis ..... A47G 9/02  
5/498
- 5,027,460 A \* 7/1991 Honig ..... A47G 9/0246  
5/497
- 5,189,744 A \* 3/1993 Roberts ..... A47G 9/0246  
5/497

(Continued)

OTHER PUBLICATIONS

CleverFit Connected Bed Sheets, Feb. 2, 2018 found on Apr. 18, 2022 at <https://www.aslanmattress.com/products/clever-fit-connected-bed-sheets> (Year: 2018).\*

(Continued)

*Primary Examiner* — Karen S Acker

(74) *Attorney, Agent, or Firm* — John F. Vodopia

(57) **CLAIM**

The Ornamental Design for a partially fitted top sheet for a mattress, as shown and described.

**DESCRIPTION**

FIG. 1 is a top, front and left perspective view of a partially fitted top sheet for a mattress;  
FIG. 2 is a top plan view thereof;  
FIG. 3 is a bottom plan view thereof;  
FIG. 4 is a front elevation view thereof;  
FIG. 5 is a rear elevation view thereof;  
FIG. 6 is a right elevation view thereof;  
FIG. 7 is a left elevation view thereof; and,  
FIG. 8 is a top, front and left perspective view of the partially fitted top sheet for a mattress shown in a position of use. The broken lines within the article depict portions of the partially fitted top sheet for a mattress that form no part of the claimed design. The broken lines illustrating a bed and mattress in FIG. 8 depict environmental subject matter that forms no part of the claimed design.

**1 Claim, 5 Drawing Sheets**

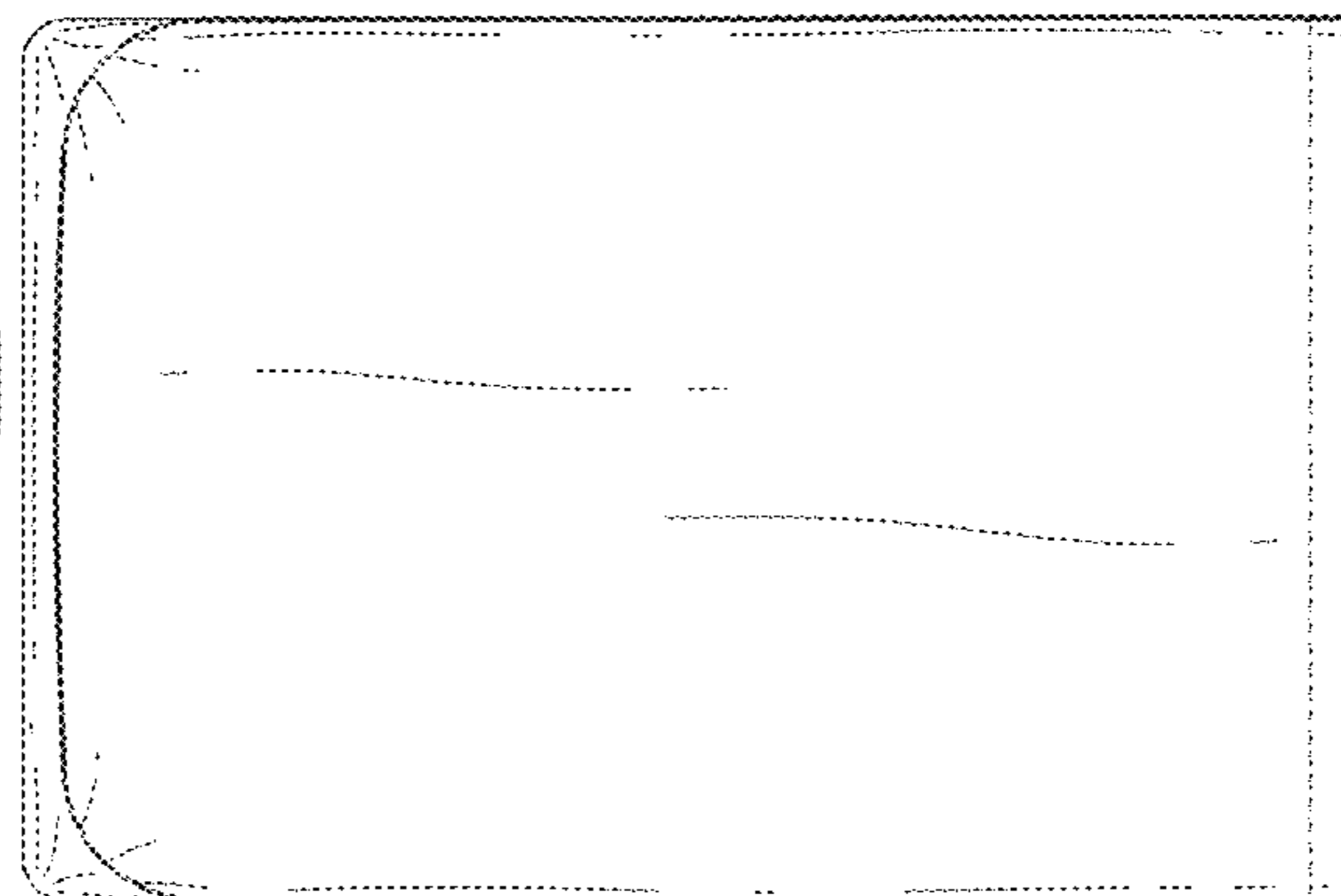
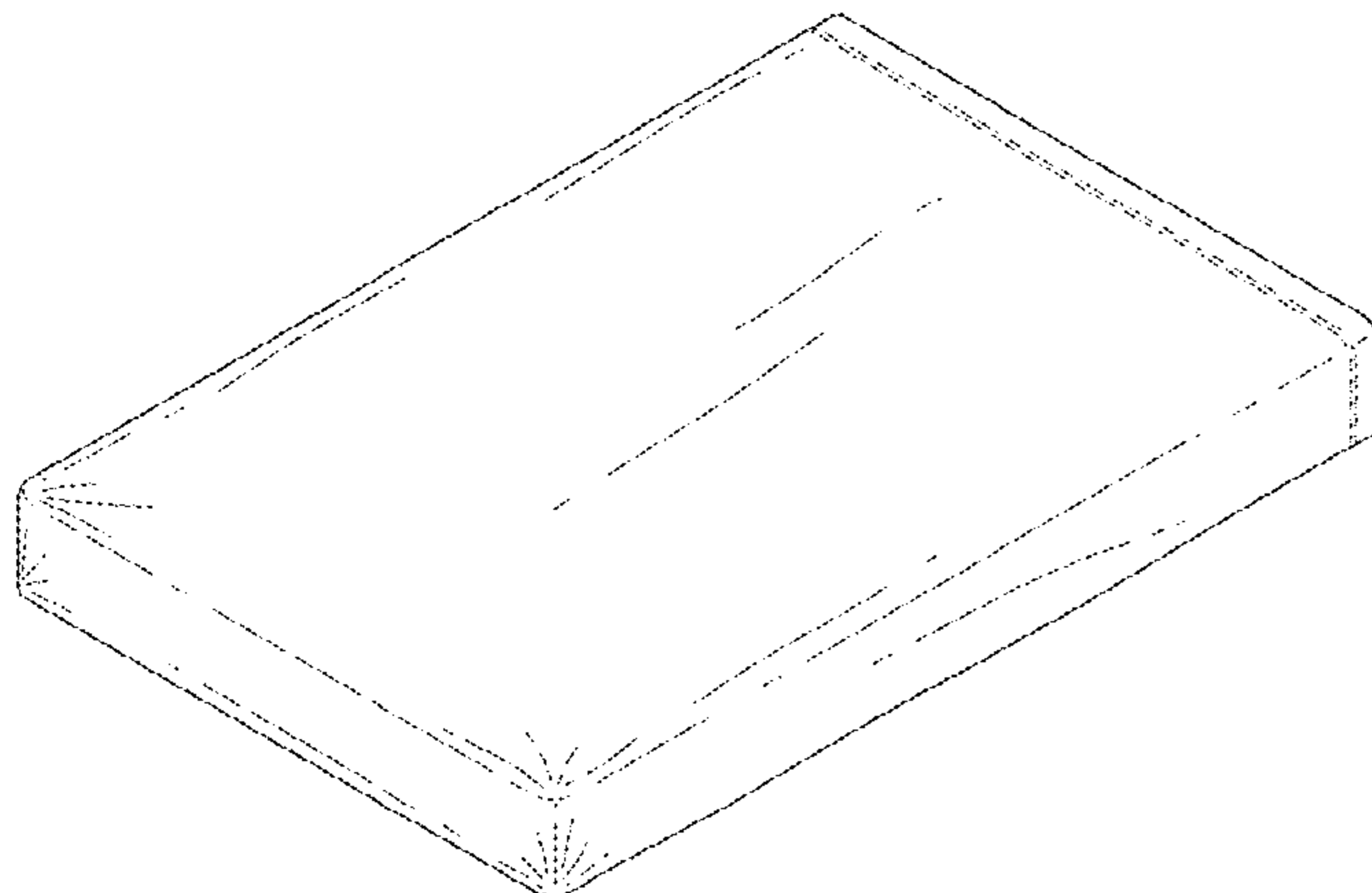

(56)

References Cited

U.S. PATENT DOCUMENTS

D338,796 S \* 8/1993 Staudinger ..... A47C 27/001  
D6/596  
5,465,440 A \* 11/1995 Heptner ..... A47G 9/0246  
5/495  
D383,028 S \* 9/1997 Pierce ..... D6/602  
D388,997 S \* 1/1998 Trower ..... D6/602  
5,884,349 A \* 3/1999 Gretsinger ..... A47G 9/02  
5/497  
5,901,389 A \* 5/1999 Manner ..... A47G 9/02  
5/482  
D433,865 S \* 11/2000 Willbanks ..... A47G 9/0246  
D6/602  
D437,722 S \* 2/2001 Ierino ..... D6/596  
6,532,608 B2 \* 3/2003 Schreiner ..... A47G 9/0246  
5/497  
6,725,477 B2 \* 4/2004 Ciaglia ..... A47G 9/02  
5/497  
7,086,102 B1 \* 8/2006 Frazier ..... A47G 9/02  
5/497  
7,260,858 B2 \* 8/2007 Cushing ..... A47G 9/0246  
5/497  
7,302,721 B1 \* 12/2007 Dorr ..... 5/485  
7,380,297 B2 \* 6/2008 Bauer ..... A47G 9/0207  
5/482  
D583,606 S \* 12/2008 Mazzuca ..... D6/606  
8,336,137 B2 \* 12/2012 Aprile ..... A47G 9/0246  
5/497  
D677,961 S \* 3/2013 McKee ..... A47G 9/0246  
D6/595  
D681,996 S \* 5/2013 Jimenez-Hernandez ..... D6/602  
8,601,621 B2 \* 12/2013 Aprile ..... A47G 9/0246  
5/497  
D698,585 S \* 2/2014 McClutchen ..... A47G 9/0246  
D6/596  
D698,587 S \* 2/2014 Caines ..... D6/602  
D699,983 S \* 2/2014 Polesuk ..... A47G 9/0246  
D6/602

9,038,213 B2 \* 5/2015 Cuneo ..... A47G 9/0246  
5/497  
9,138,060 B2 \* 9/2015 Vainberg ..... A47C 31/116  
9,167,919 B2 \* 10/2015 Walker ..... A47C 27/007  
9,247,835 B2 \* 2/2016 Blethen ..... A47G 9/0246  
D773,209 S \* 12/2016 Jaigobin ..... A47G 9/02  
D6/596  
D773,859 S \* 12/2016 Feldman ..... D6/602  
D792,124 S \* 7/2017 Blatt ..... A47G 9/0246  
D6/596  
D806,442 S \* 1/2018 Alletto, Jr. ..... D6/602  
D867,787 S \* 11/2019 Stricklen ..... D6/602  
10,624,475 B2 \* 4/2020 Holt ..... A47C 27/001  
D893,918 S \* 8/2020 Palit ..... D6/603  
D907,401 S \* 1/2021 Joy ..... D6/602  
D960,609 S \* 8/2022 Tak ..... D6/602  
D968,850 S \* 11/2022 Yao ..... D6/602  
2006/0248646 A1 \* 11/2006 Marsh ..... A47G 9/0246  
5/494  
2009/0313757 A1 \* 12/2009 Walsh-Barltrop .... A61F 5/3784  
5/424  
2011/0012405 A1 \* 1/2011 Conforti ..... A47C 7/62  
297/223  
2018/0360227 A1 \* 12/2018 Martin ..... A47G 9/0246  
2020/0128979 A1 \* 4/2020 Hinman ..... A47G 9/0223

OTHER PUBLICATIONS

Effortless Bedding, Nov. 14, 2016, found on Apr. 18, 2022 at [https://www.amazon.com/Effortless-Microfiber-Twin-Sage-Green/dp/B014A6D612/ref=sr\\_1\\_7?crid=2K02DY98P3BP5&keywords=semi%2Bfitted%2Btop%2Bsheet&qid=1650305966&sr=8-7&th=1](https://www.amazon.com/Effortless-Microfiber-Twin-Sage-Green/dp/B014A6D612/ref=sr_1_7?crid=2K02DY98P3BP5&keywords=semi%2Bfitted%2Btop%2Bsheet&qid=1650305966&sr=8-7&th=1) (Year: 2016).  
Effortless Plush, Sep. 11, 2015, found on Apr. 18, 2022 at [https://www.amazon.com/Effortless-Bedding-Oversized-Semi-Fitted-California/dp/B014QZ5NUQ?ref=ast\\_sto\\_dp&th=1](https://www.amazon.com/Effortless-Bedding-Oversized-Semi-Fitted-California/dp/B014QZ5NUQ?ref=ast_sto_dp&th=1) (Year: 2015).\*

\* cited by examiner

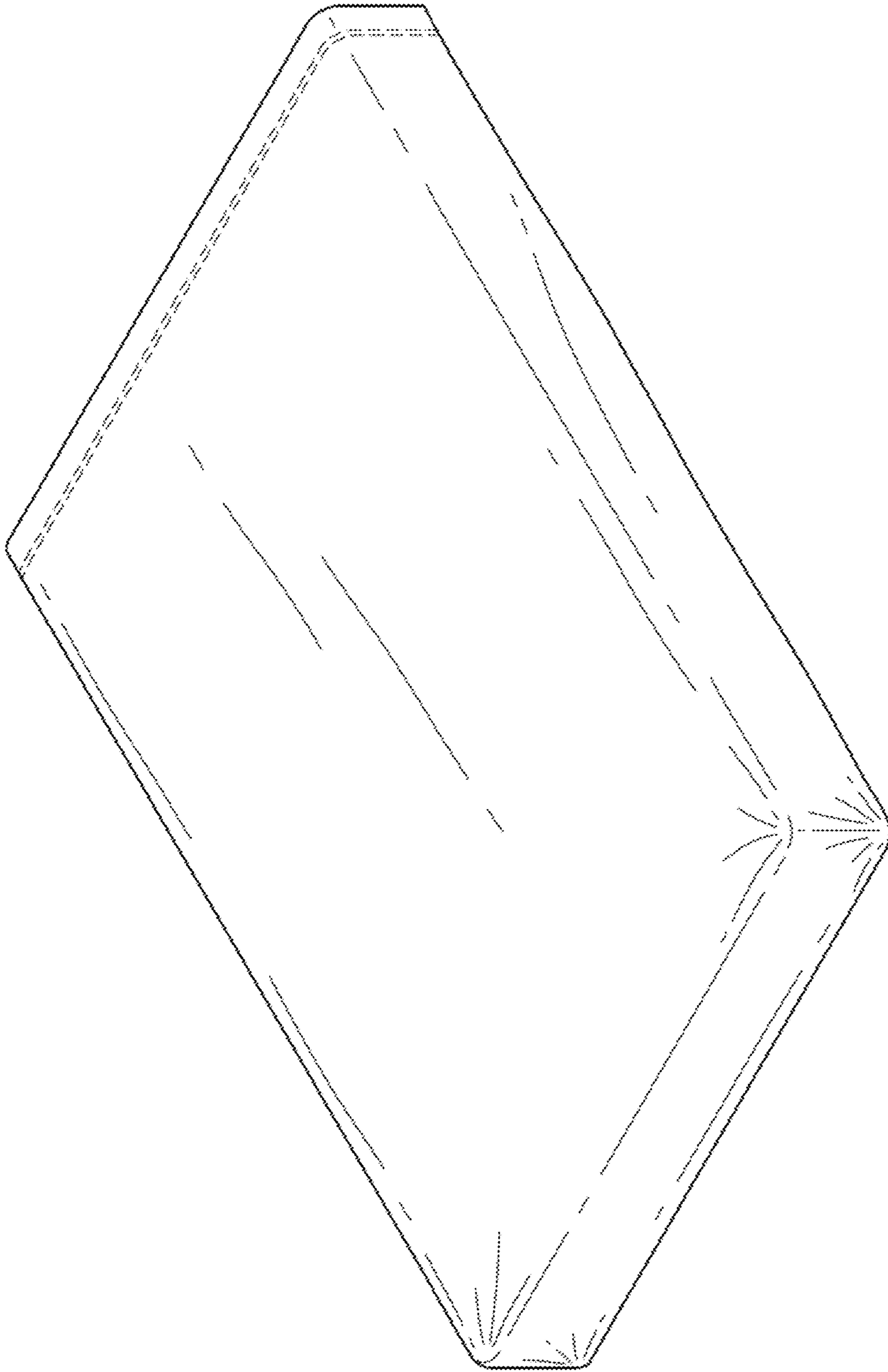

FIG. 1

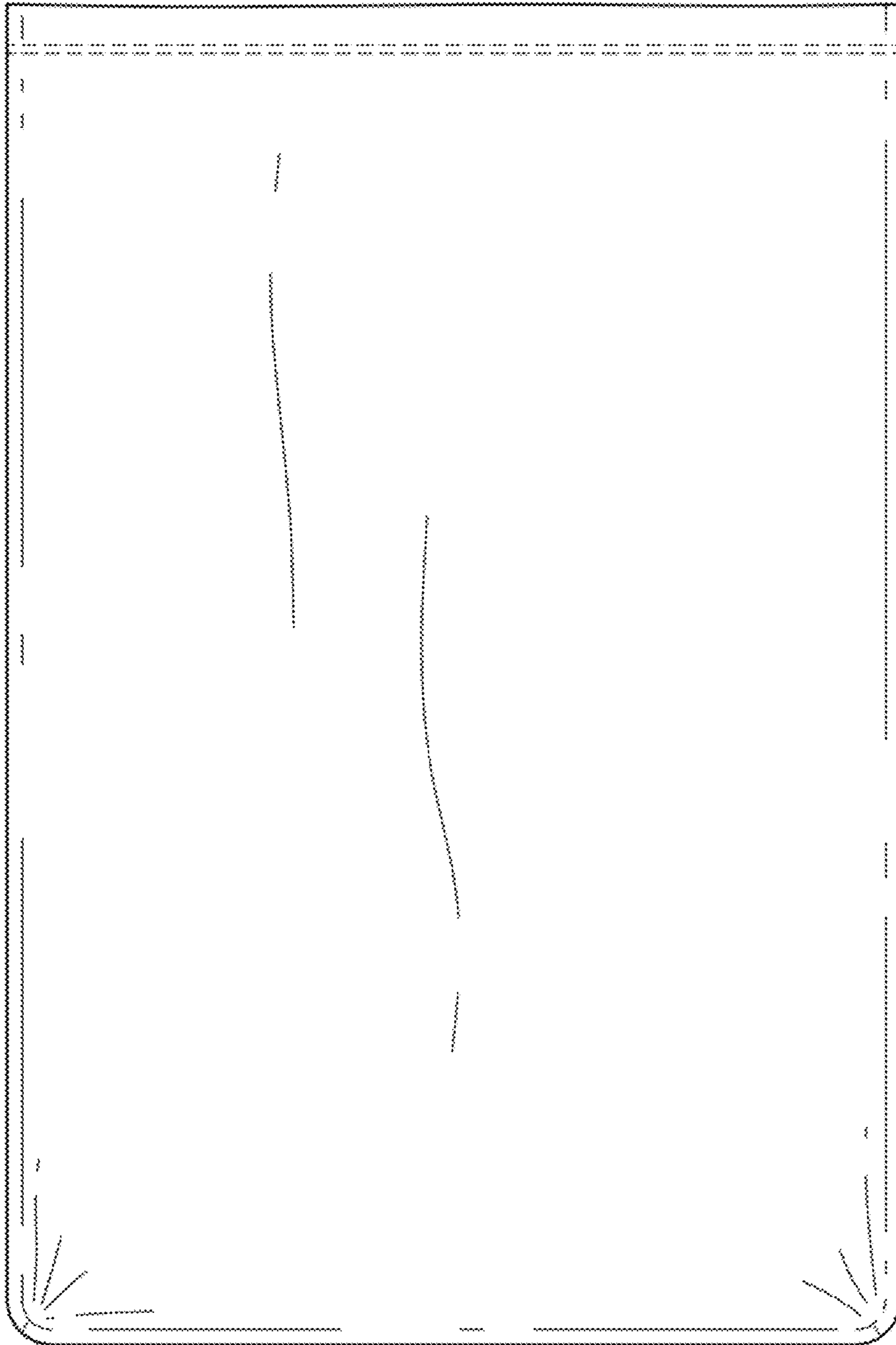

FIG. 2

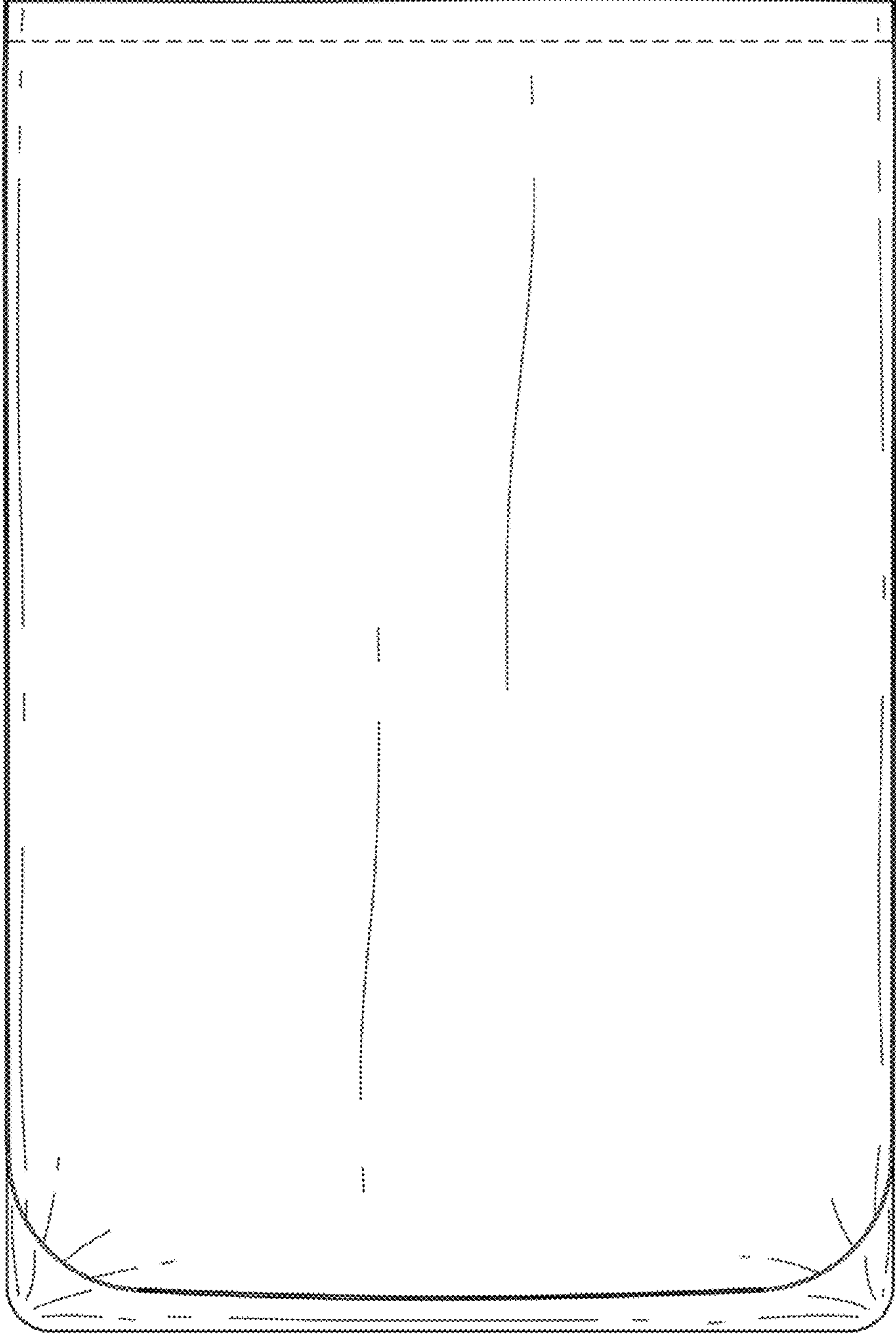

FIG. 3

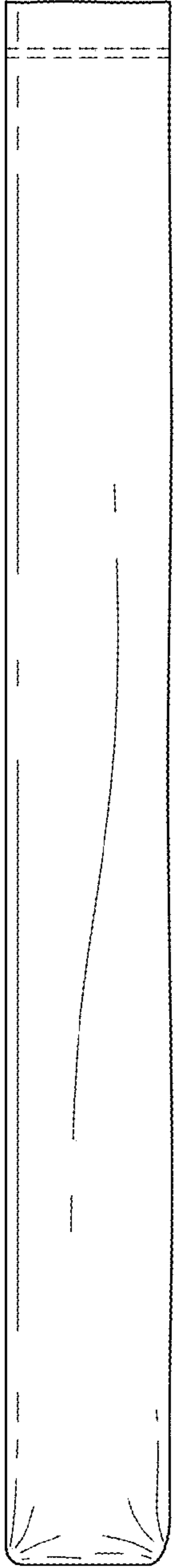

FIG. 4

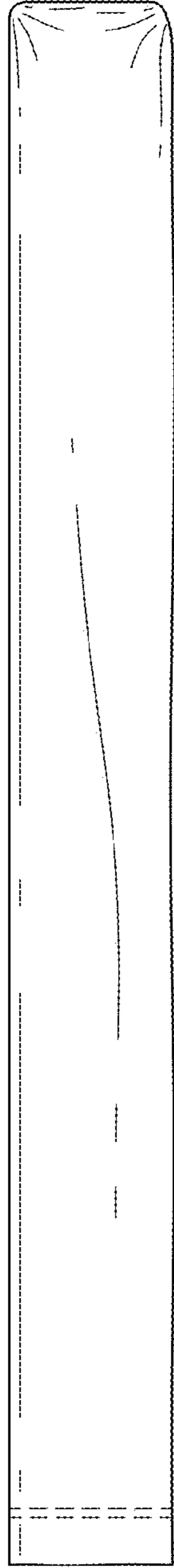

FIG. 5

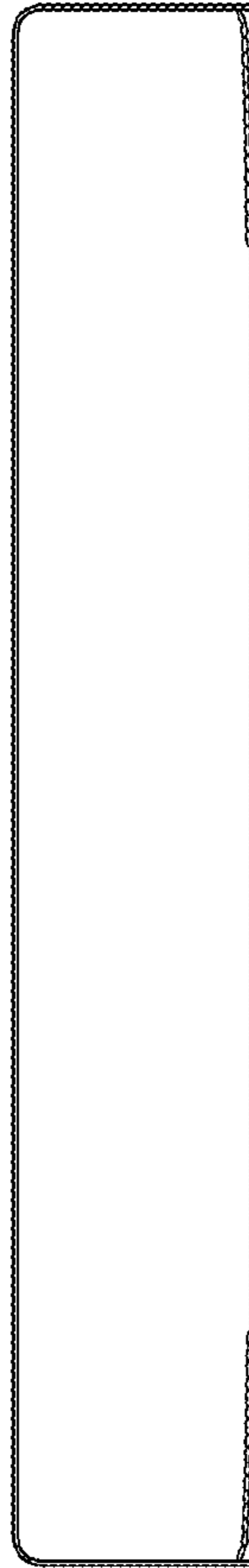

FIG. 6

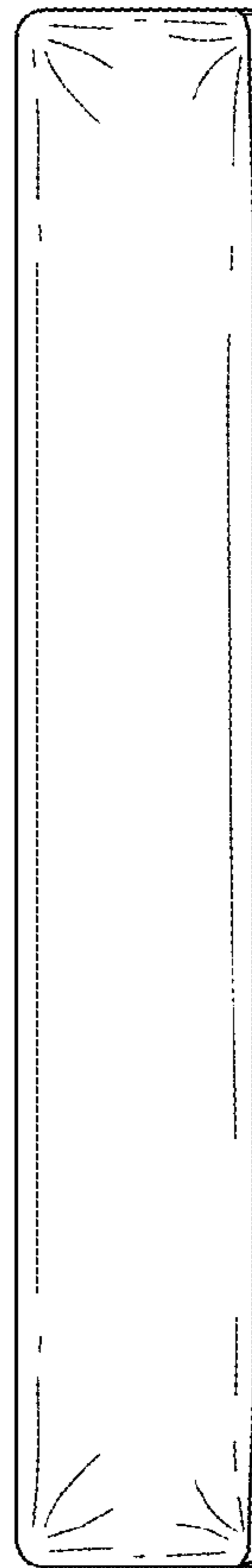

FIG. 7

