



US00D978461S

(12) **United States Design Patent**  
**Wang**

(10) **Patent No.:** **US D978,461 S**

(45) **Date of Patent:** **\*\* Feb. 14, 2023**

(54) **PET STEP**

(71) Applicant: **Jiyun Wang**, Zhejiang (CN)

(72) Inventor: **Jiyun Wang**, Zhejiang (CN)

(\*\*) Term: **15 Years**

(21) Appl. No.: **29/860,250**

(22) Filed: **Nov. 17, 2022**

(51) **LOC (14) Cl.** ..... **30-03**

(52) **U.S. Cl.**  
USPC ..... **D30/199**; D25/63

(58) **Field of Classification Search**

USPC ..... D30/199, 119, 160, 108, 118, 158, 161;  
119/843, 849, 847, 706-711, 28.5, 165,  
119/702, 485, 498; D25/63, 65, 62, 64,  
D25/66-69; 182/1, 20, 200, 33, 107,  
182/230, 129, 106, 93, 95, 115, 113, 151,  
182/35, 46, 222; 248/188.2; 52/182,  
52/184, 188, 190; 114/362; 14/71.1,  
14/69.5; 193/2 R, 33; D6/349-355, 335,  
D6/684, 406.6, 406.5, 535, 690, 691,  
D6/691.1-691.4, 691.8, 687, 686;  
D12/203; 280/166; 296/156; 105/443,  
105/447, 448; 297/118; 4/254, 483, 485,  
4/574.1, 578.1, 902, 572.1, 571.1;  
D23/296, 299, 309, 311; D21/686, 687,  
D21/690, 695, 671, 685, 521, 522;  
482/52, 142, 143; 473/476; D14/451,  
D14/447; D7/619.1, 698, 552.2, 554.3,  
D7/550.1

CPC ..... A01K 1/035; E04F 11/066; E04F 11/062;  
E04F 11/06; E04F 11/04; E04F 11/022;  
E04F 11/0223; E04F 11/0226; E04F  
11/035; E04F 2011/0203-0209; E04F  
2011/0218; E06C 1/383; E06C 1/3835;  
E06C 1/387; E06C 1/00; E06C 1/005;  
E06C 1/04; E06C 1/12; E06C 1/14; E06C  
1/16; E06C 1/30; E06C 1/38; E06C  
1/381; B60R 3/007; B60R 3/02; A47K  
11/06; A47K 11/08; A47K 11/12; A47K

17/028; A61G 9/00; A63B 23/0458;  
A47C 12/00; A47C 12/02; A47C 13/00;  
A47C 13/005; A47C 16/02; A47C 16/04;  
A47C 11/00; A47C 9/00; A47C 9/002;  
A47C 9/02; A47C 9/025; A47C 9/027;  
A47C 9/04; A47C 9/08; A47C 9/10

See application file for complete search history.

(56) **References Cited**

U.S. PATENT DOCUMENTS

361,983 A \* 4/1887 Brown ..... G02B 27/34  
404/22  
2,205,859 A \* 6/1940 O'Donnell ..... E04F 11/025  
52/188

(Continued)

*Primary Examiner* — Susan Moon Lee

(57) **CLAIM**

The ornamental design for a pet step, as shown and described.

**DESCRIPTION**

FIG. 1 is a front and top perspective view of a pet step, showing my new design;  
FIG. 2 is a rear and bottom perspective view thereof;  
FIG. 3 is a front elevation view thereof;  
FIG. 4 is a rear elevation view thereof;  
FIG. 5 is a left side elevation view thereof;  
FIG. 6 is a right side elevation view thereof;  
FIG. 7 is a top plan view thereof;  
FIG. 8 is a bottom plan view thereof; and,  
FIG. 9 is an enlarged perspective view of detail "9" identified in FIG. 1.

The dashed lines in the figures illustrate portions of the pet step that form no part of the claimed design. The dash dot dash lines in FIGS. 1 and 9 are for the purpose of illustrating the enlarged view indicators and form no part of the claimed design.

**1 Claim, 9 Drawing Sheets**

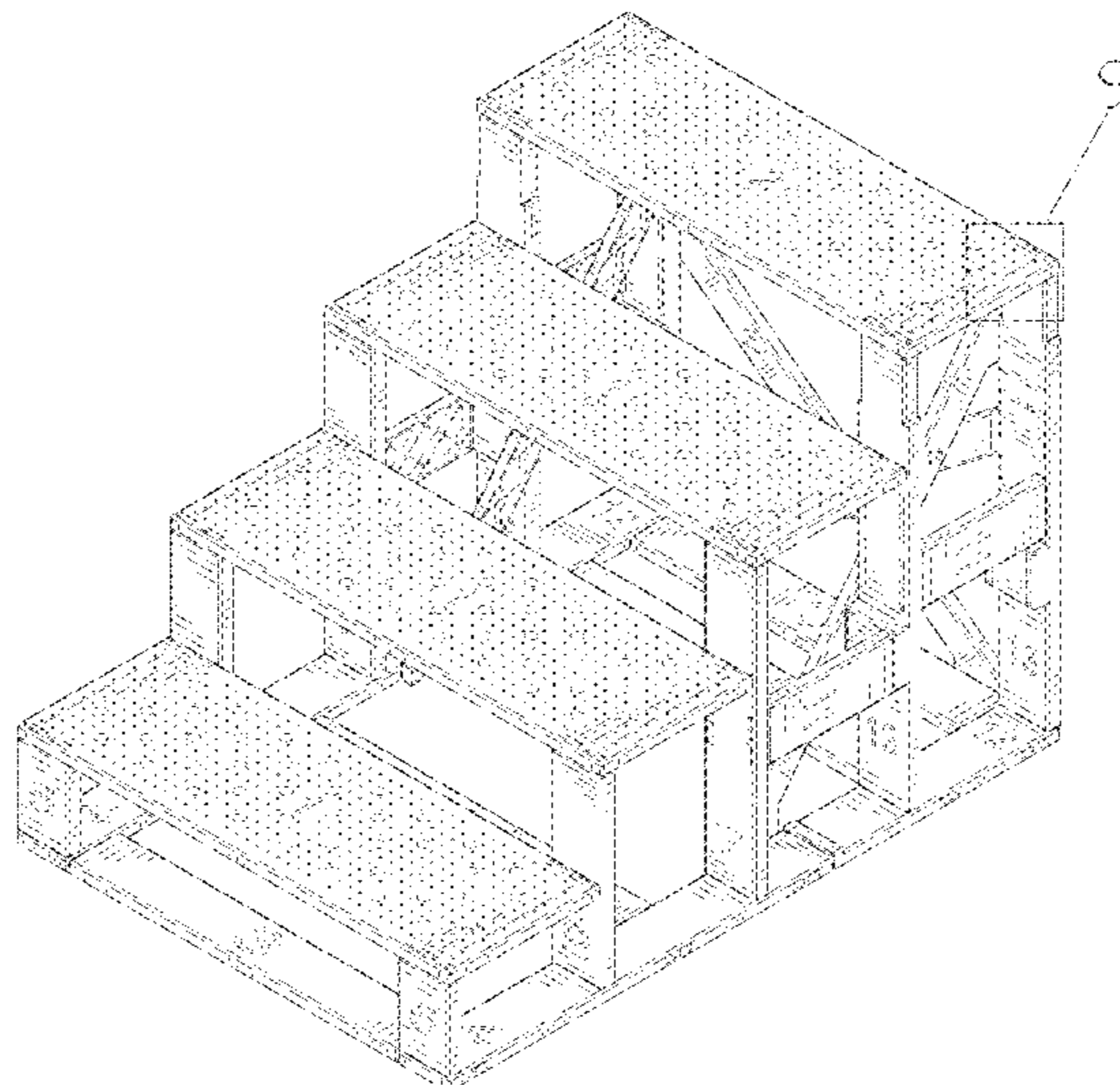

(56)

References Cited

U.S. PATENT DOCUMENTS

2,287,561 A \* 6/1942 Page ..... E04H 3/12  
52/690  
2,551,345 A \* 5/1951 Scott ..... B63B 27/14  
105/326  
2,939,309 A \* 6/1960 Sitton ..... E04F 11/025  
D25/63  
2,949,703 A \* 8/1960 Katzmarek ..... E04F 11/022  
D25/63  
3,099,336 A \* 7/1963 Hawkins ..... E04F 11/035  
182/178.1  
3,578,110 A \* 5/1971 Seagraves ..... E04F 11/02  
D25/63  
3,593,821 A \* 7/1971 Lister ..... E04F 11/06  
182/115  
3,709,323 A \* 1/1973 Tribble ..... E06C 1/14  
182/1  
4,108,457 A \* 8/1978 Garrett ..... B60R 3/02  
182/95  
4,367,613 A \* 1/1983 Strub ..... E04F 11/025  
52/741.2  
D375,290 S \* 11/1996 Hall ..... D12/318  
5,941,342 A \* 8/1999 Lee ..... B60R 3/02  
182/95  
6,205,722 B1 \* 3/2001 Bromley ..... E04F 11/025  
52/182  
6,397,529 B1 \* 6/2002 Grenier ..... E04F 11/0255  
52/190  
6,438,909 B2 \* 8/2002 Birch ..... E04F 11/00  
52/177  
D479,338 S \* 9/2003 Hennessy ..... D25/63  
6,763,912 B2 \* 7/2004 Robinson ..... E06C 1/39  
182/115  
D555,845 S \* 11/2007 Khubani ..... D30/199  
7,500,335 B1 \* 3/2009 Kjose ..... E04H 3/28  
52/79.5  
7,617,652 B1 \* 11/2009 Flatmoe ..... E04F 11/025  
52/263

7,621,236 B2 \* 11/2009 Steffey ..... A01K 1/035  
182/180.1  
D640,015 S \* 6/2011 Birck ..... D25/63  
8,091,294 B2 \* 1/2012 Whalen ..... A01K 1/035  
52/182  
8,627,926 B2 \* 1/2014 Gordon ..... E04F 11/02  
182/115  
D729,991 S \* 5/2015 Freiberg ..... D25/63  
D756,574 S \* 5/2016 Jakubowski ..... D30/199  
9,380,760 B2 \* 7/2016 Rorke ..... A01K 1/035  
9,499,991 B2 \* 11/2016 Preston ..... E04F 11/04  
9,527,448 B1 \* 12/2016 Kay ..... E06C 9/14  
D802,227 S \* 11/2017 Florey ..... D6/675.3  
D819,229 S \* 5/2018 Hoffman ..... D25/63  
D838,384 S \* 1/2019 Monnin ..... D25/63  
10,358,871 B2 \* 7/2019 Honeycutt ..... E04G 1/15  
D887,022 S \* 6/2020 Saccoccio ..... E06C 7/00  
D25/63  
D903,212 S \* 11/2020 Qiu ..... D30/119  
D910,250 S \* 2/2021 Fink ..... D25/63  
10,918,086 B2 \* 2/2021 Sarver ..... A01K 15/027  
D919,904 S 5/2021 Pollack  
11,268,276 B2 \* 3/2022 Oliver ..... E04F 11/1844  
11,447,965 B2 \* 9/2022 Honeycutt ..... E04G 1/17  
2002/0153201 A1 \* 10/2002 Warford ..... E06C 1/39  
182/115  
2002/0189177 A1 \* 12/2002 Eve ..... E04F 11/175  
52/182  
2004/0040785 A1 \* 3/2004 Robinson ..... E06C 1/39  
182/115  
2004/0244724 A1 \* 12/2004 Runge ..... A01K 1/035  
119/847  
2006/0230693 A1 \* 10/2006 Giordano ..... E04G 21/30  
52/182  
2007/0089690 A1 \* 4/2007 Khubani ..... A01K 1/035  
119/847  
2011/0209672 A1 \* 9/2011 Moore, III ..... A01K 1/035  
119/847  
2014/0123910 A1 \* 5/2014 Rorke ..... A01K 1/035  
119/849  
2019/0387706 A1 \* 12/2019 Bachman ..... E06C 1/393

\* cited by examiner

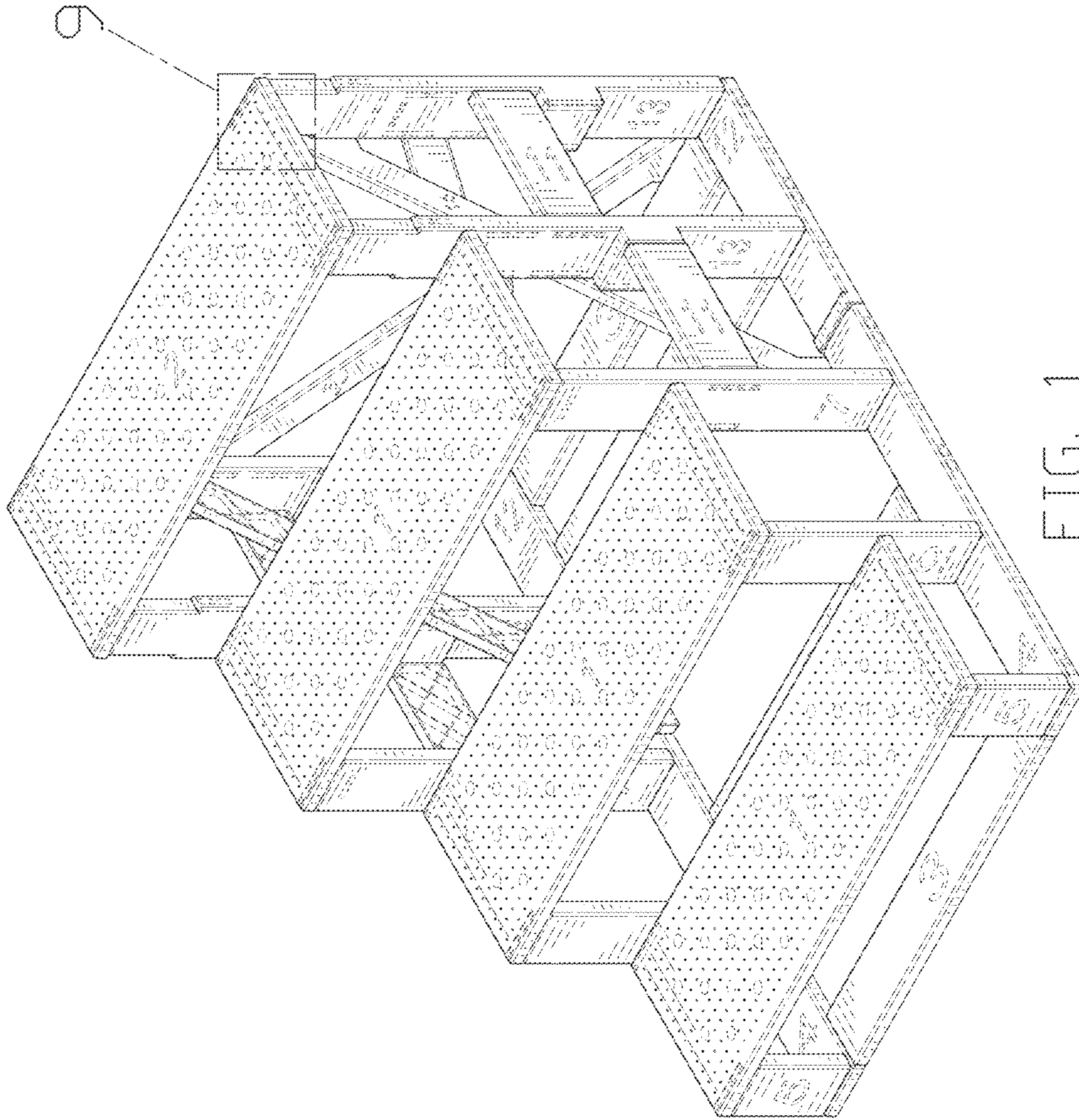

FIG. 1

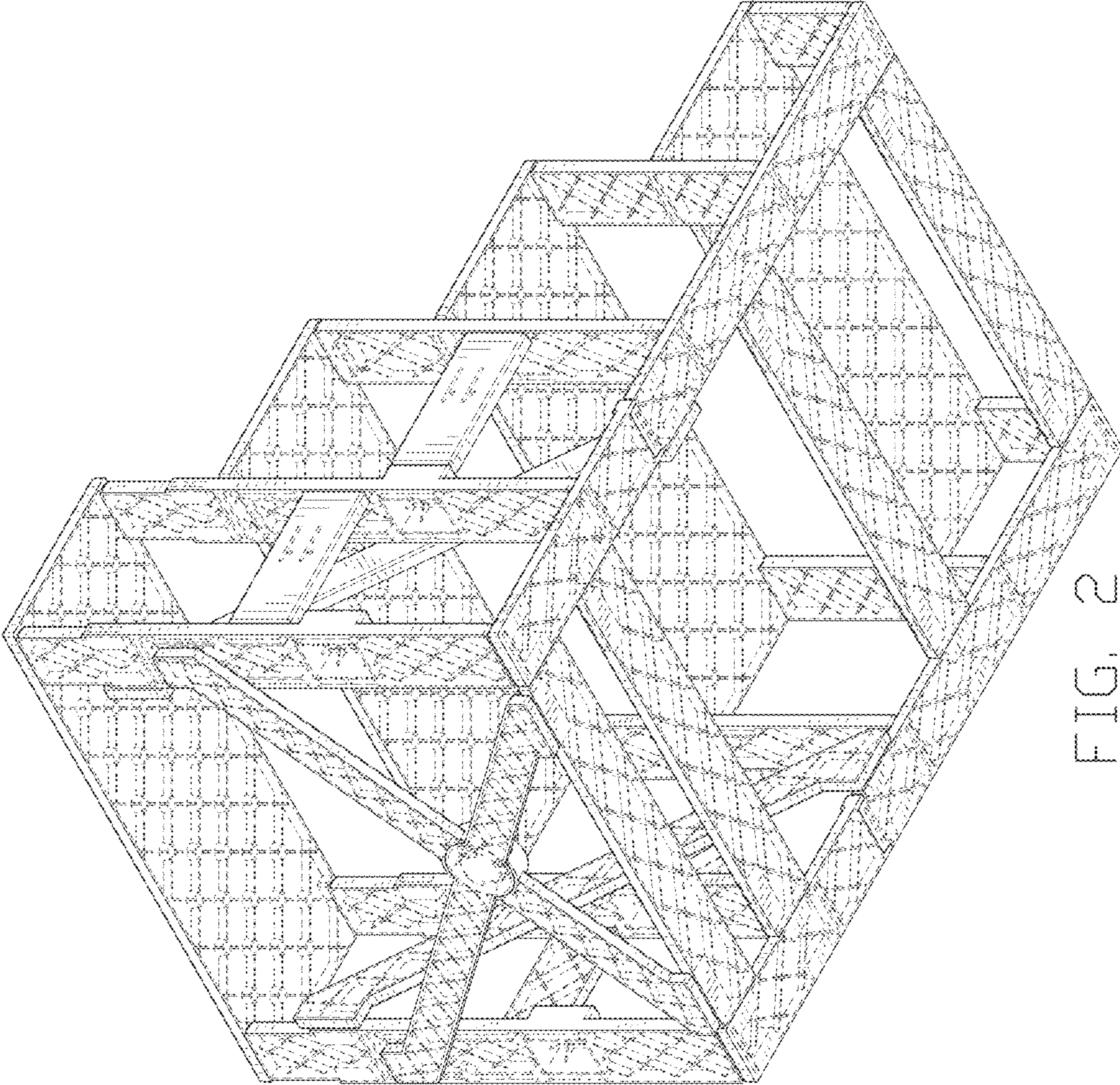

FIG. 2

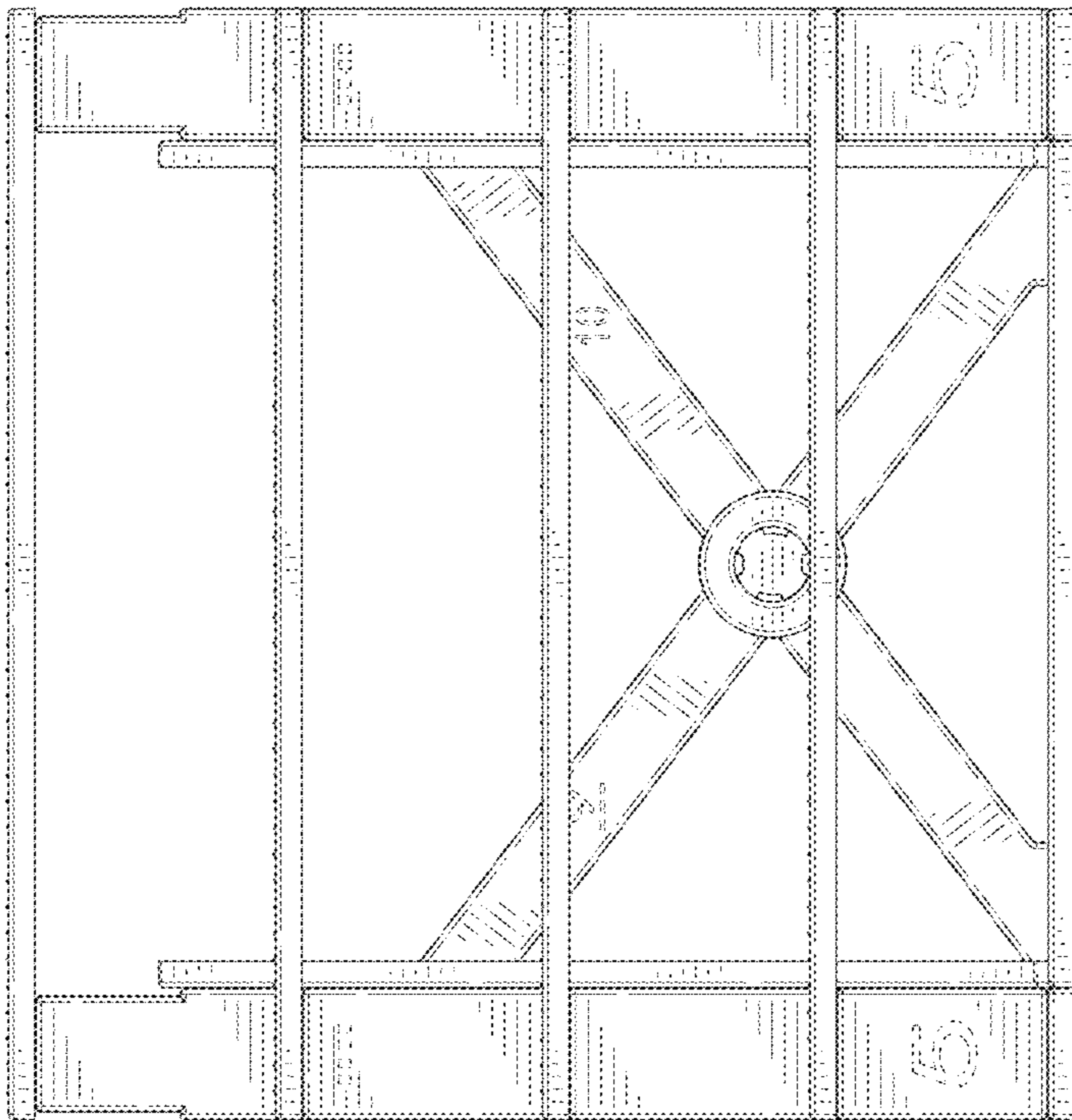

FIG. 3

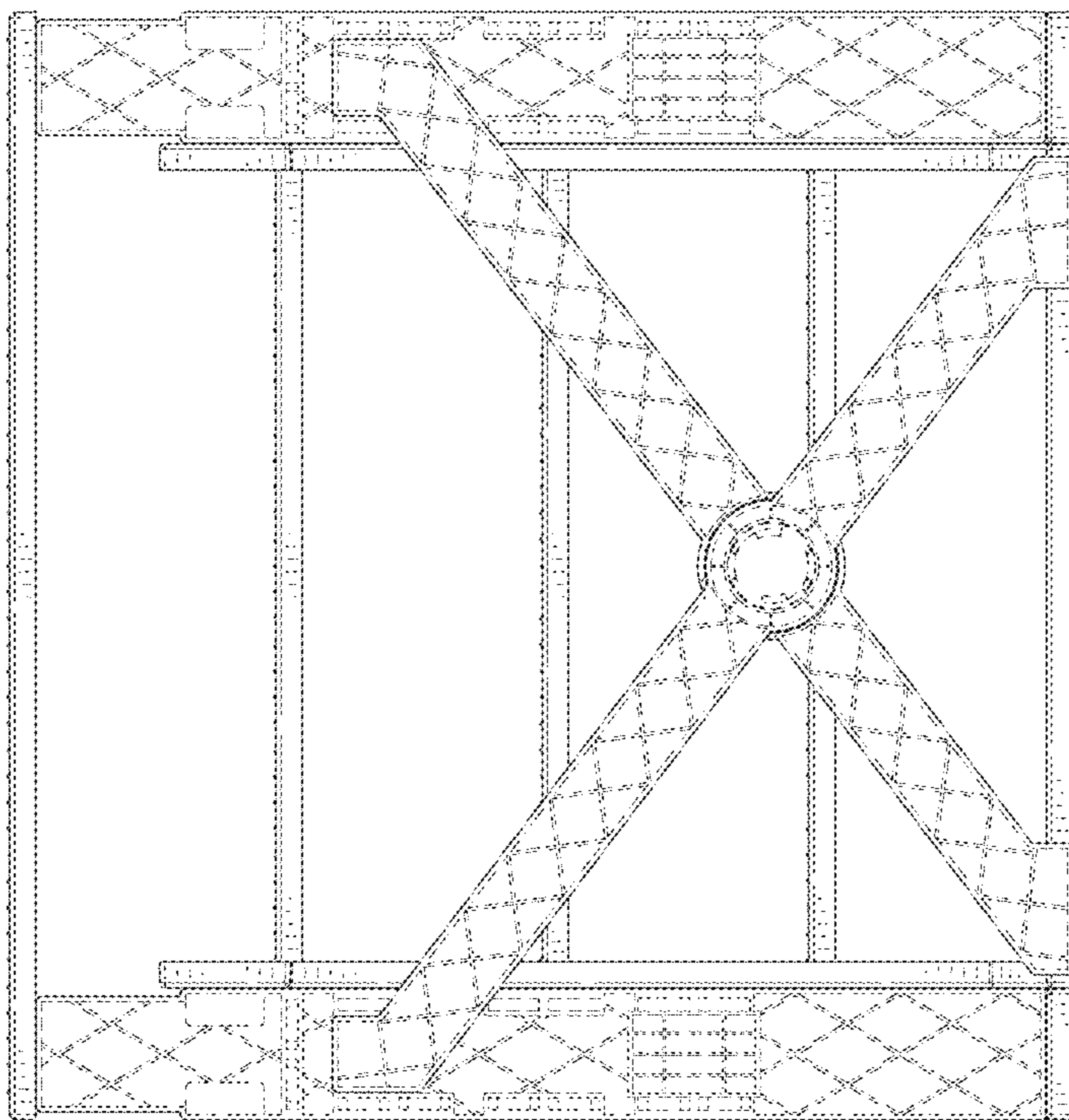

FIG. 4

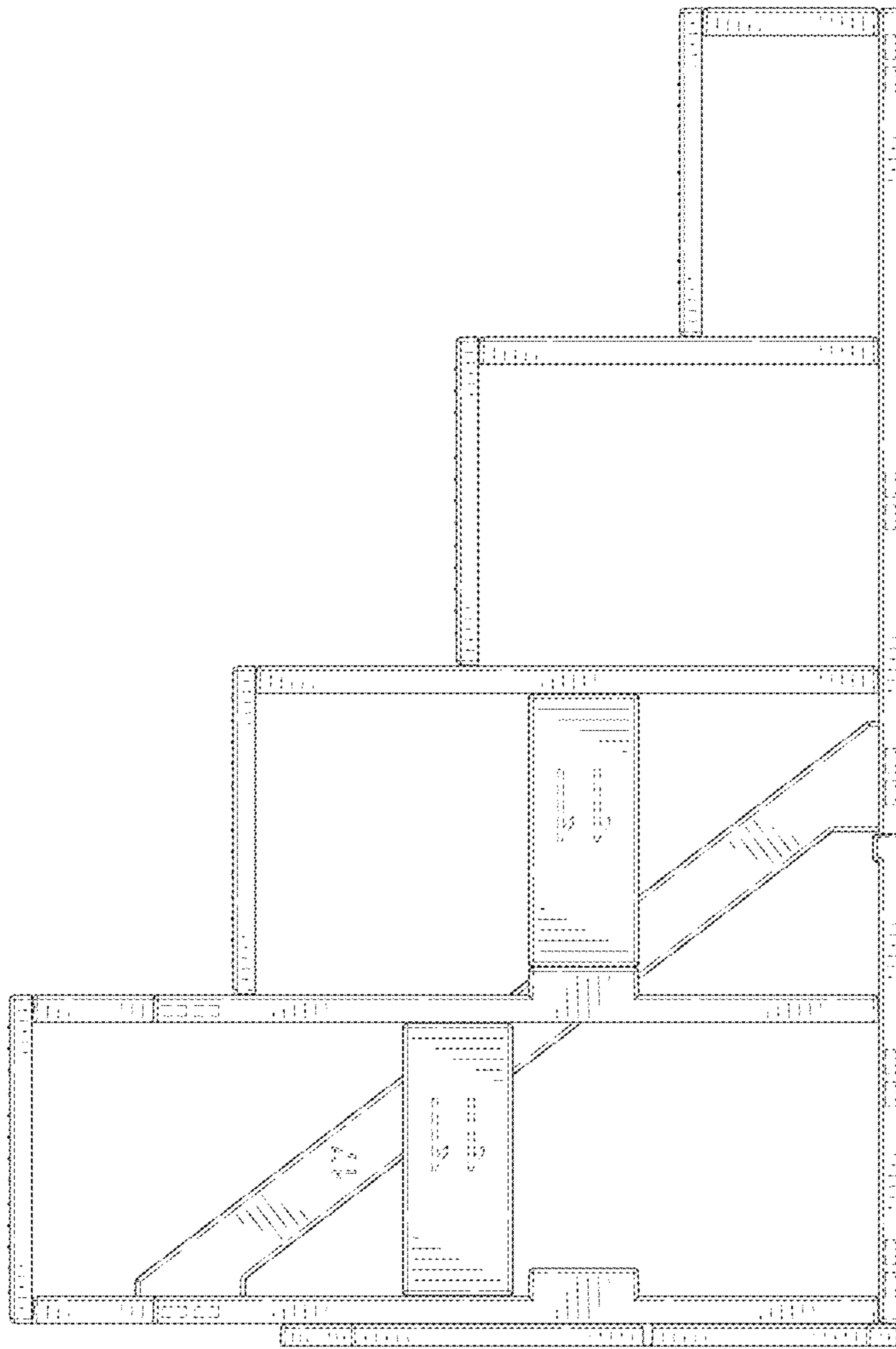

FIG. 5

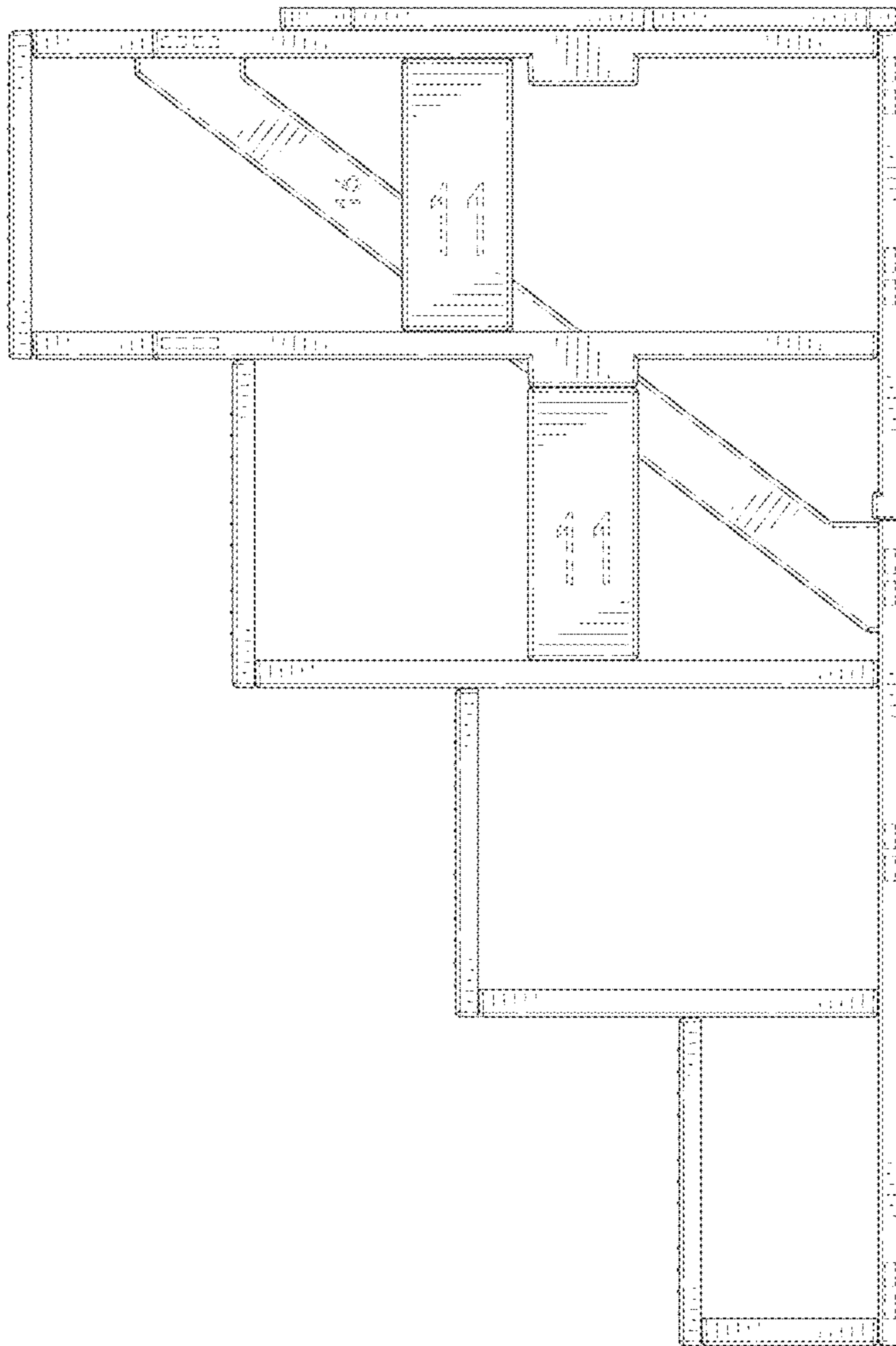

FIG. 6



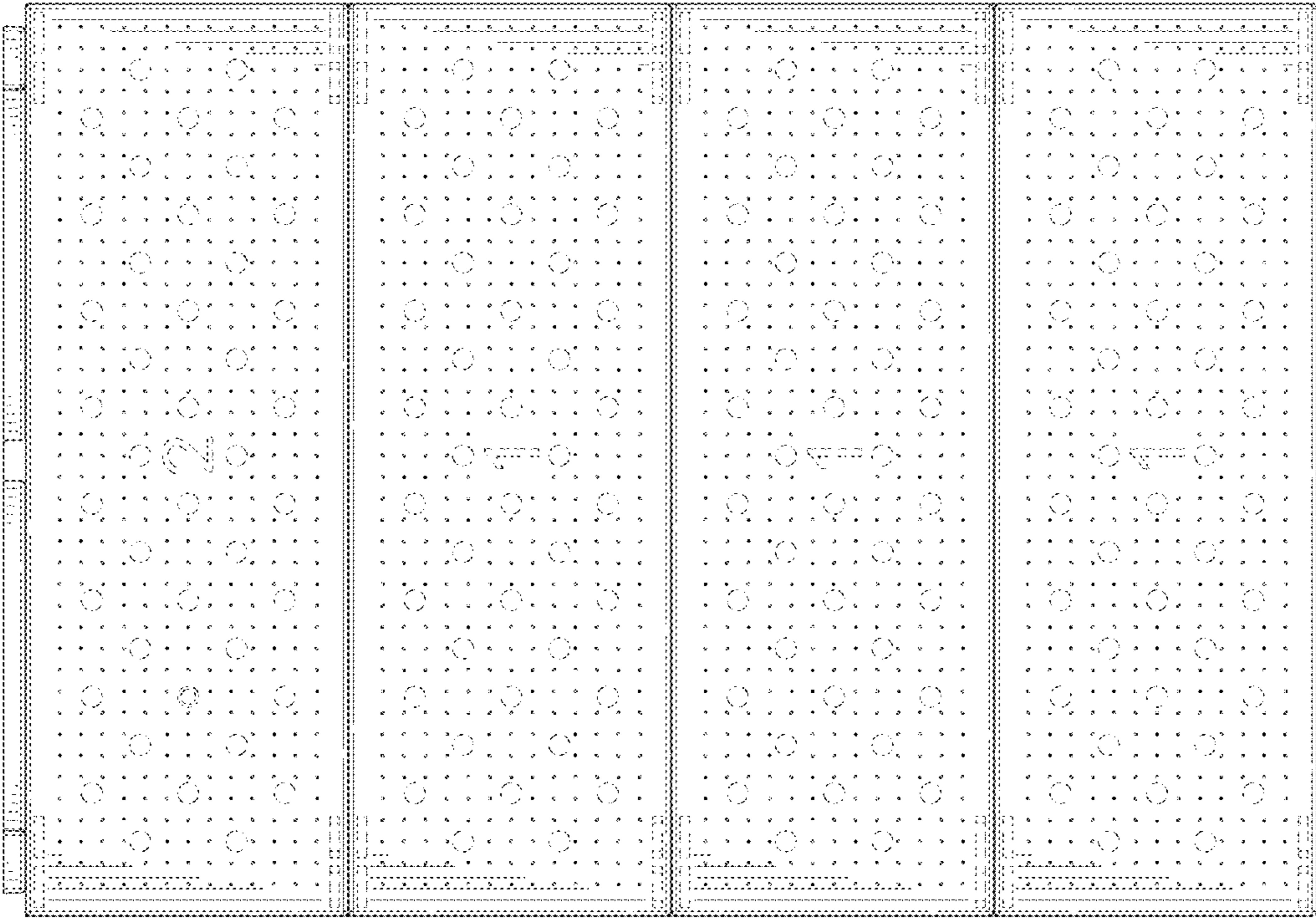

FIG. 7

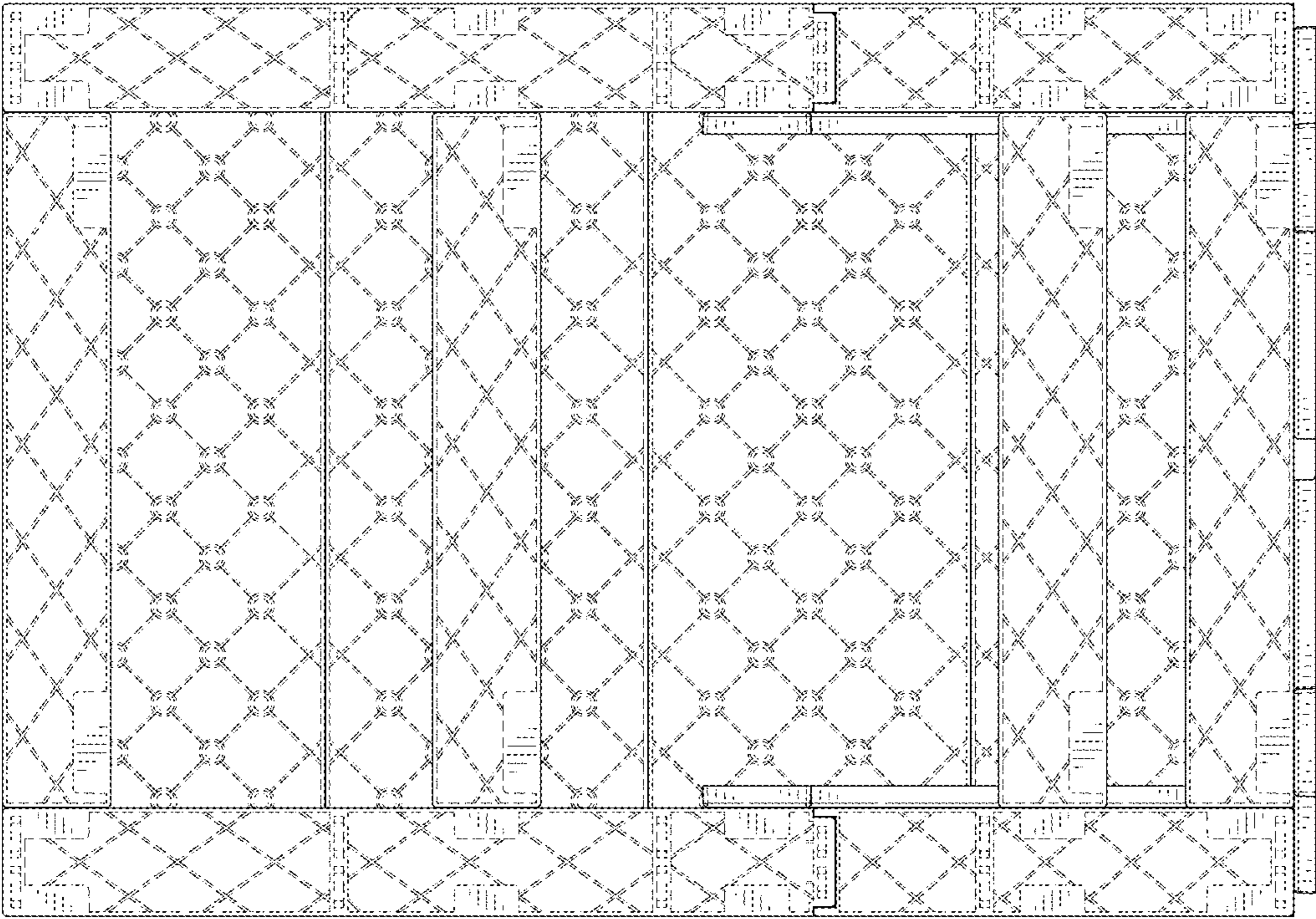

FIG. 8

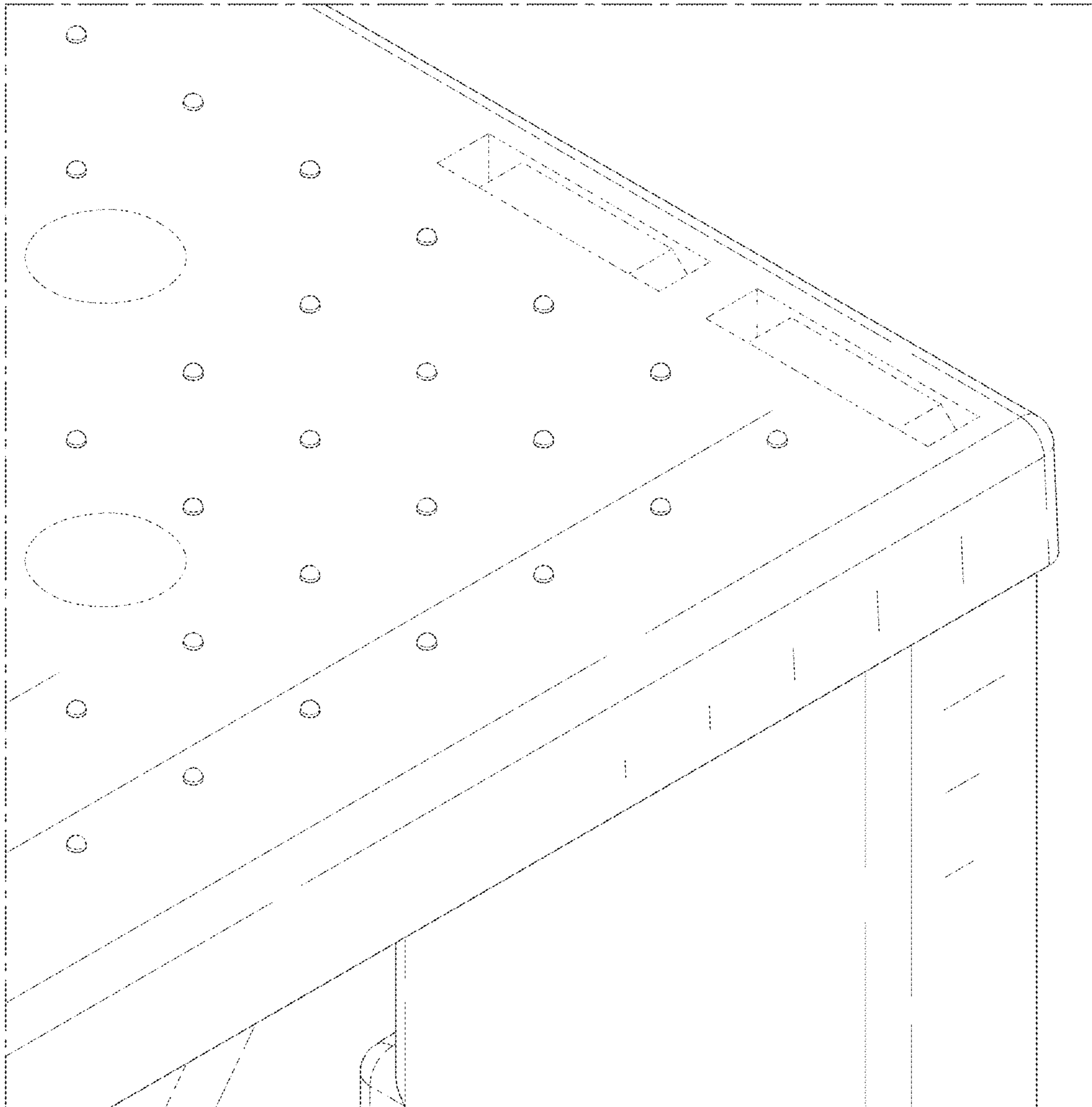

FIG. 9