

US00D978401S

(12) **United States Design Patent**
Mai

(10) **Patent No.:** **US D978,401 S**

(45) **Date of Patent:** **** Feb. 14, 2023**

(54) **LIGHT**

(71) Applicant: **Kunhua Mai**, Zhongshan (CN)

(72) Inventor: **Kunhua Mai**, Zhongshan (CN)

(**) Term: **15 Years**

(21) Appl. No.: **29/859,005**

(22) Filed: **Nov. 7, 2022**

(51) **LOC (14) Cl.** **26-03**

(52) **U.S. Cl.**

USPC **D26/67**

(58) **Field of Classification Search**

USPC D11/117, 121, 130; D26/1, 2, 4, 24, 25,
D26/27, 57, 61, 67, 73, 94, 98, 103, 110,
D26/119, 128

CPC F21V 21/0824; F21V 5/041; F21V 5/043;
F21V 5/045; F21V 5/046; F21V 5/048;
F21V 3/02; F21V 1/14; F21V 1/143;
F21V 1/24; F21V 1/20; F21V 1/22

See application file for complete search history.

(56) **References Cited**

U.S. PATENT DOCUMENTS

D309,787 S * 8/1990 Chien D26/93
D309,954 S * 8/1990 Chien D26/67

D483,138 S * 12/2003 Chen D26/67
D518,589 S * 4/2006 Harbaugh D26/68
D604,440 S * 11/2009 Chen D26/67
D694,932 S * 12/2013 Meyer D26/67
D895,876 S 9/2020 Tang
D899,659 S 10/2020 Wang
D924,458 S 7/2021 Tang

* cited by examiner

Primary Examiner — Michael A. Pratt

(74) *Attorney, Agent, or Firm* — Runit Ranjit Kanakia

(57) **CLAIM**

The ornamental design for a light, as shown and described.

DESCRIPTION

FIG. 1 is a first perspective view of a light showing my new design;

FIG. 2 is a second perspective view thereof;

FIG. 3 is a front view thereof;

FIG. 4 is a back view thereof;

FIG. 5 is a left side view thereof;

FIG. 6 is a right side view thereof;

FIG. 7 is a top view thereof; and,

FIG. 8 is a bottom view thereof.

The broken lines shown in the drawings depict portions of the light that form no part of the claimed design.

1 Claim, 8 Drawing Sheets

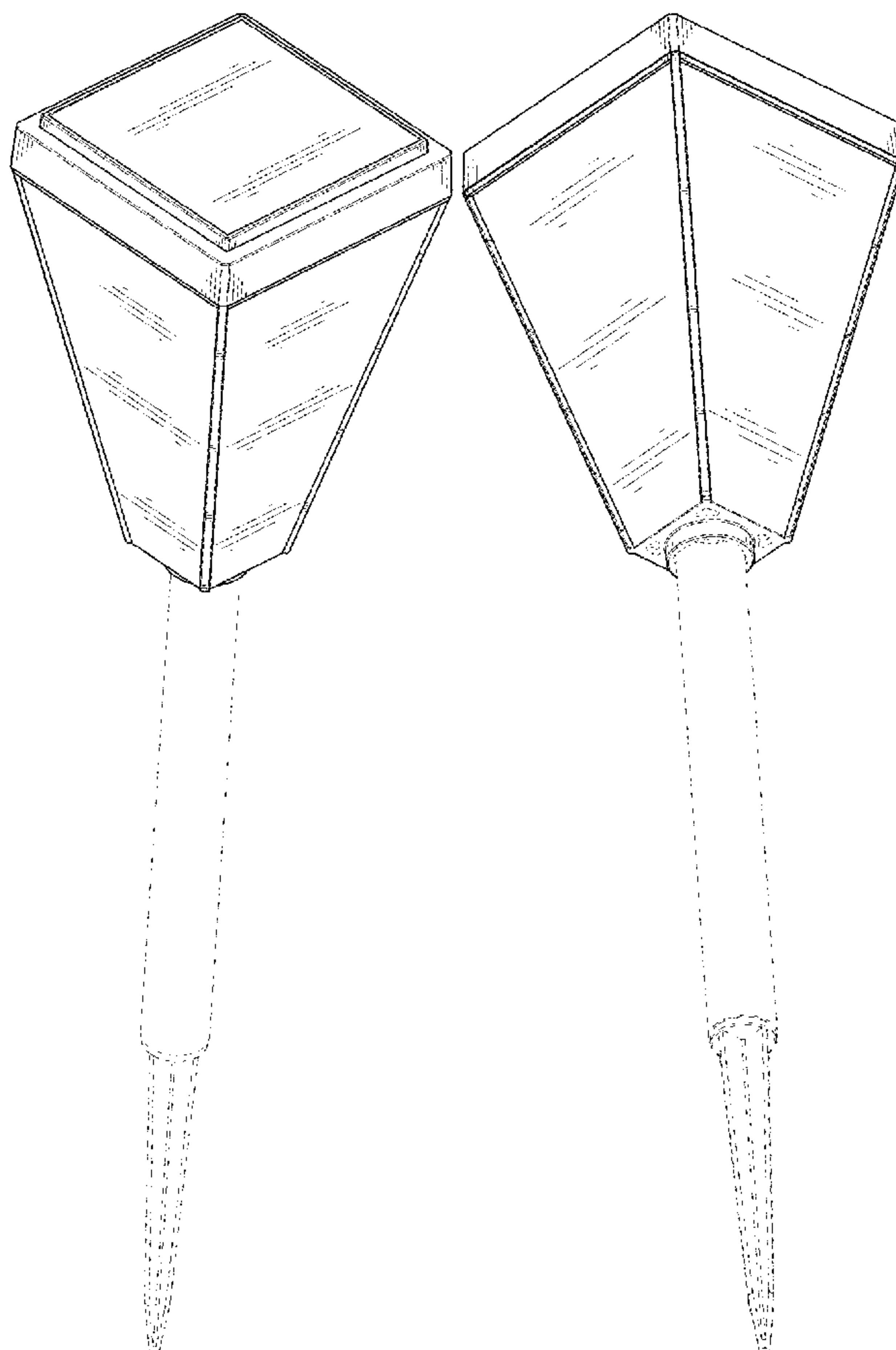

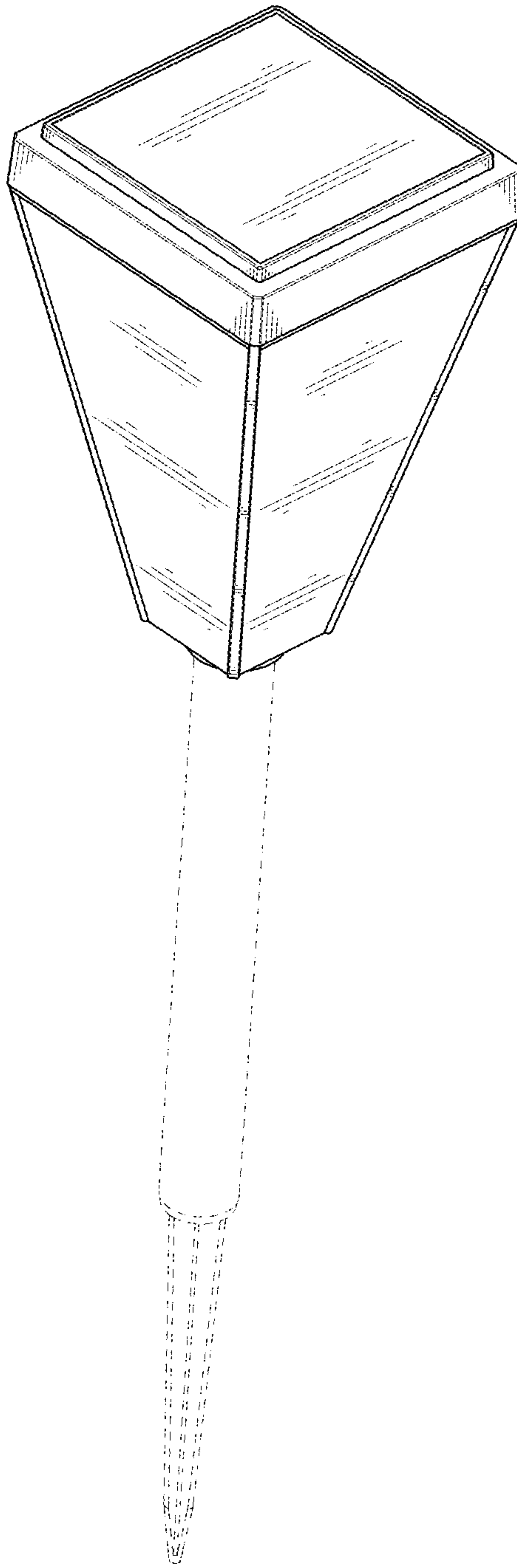

FIG. 1

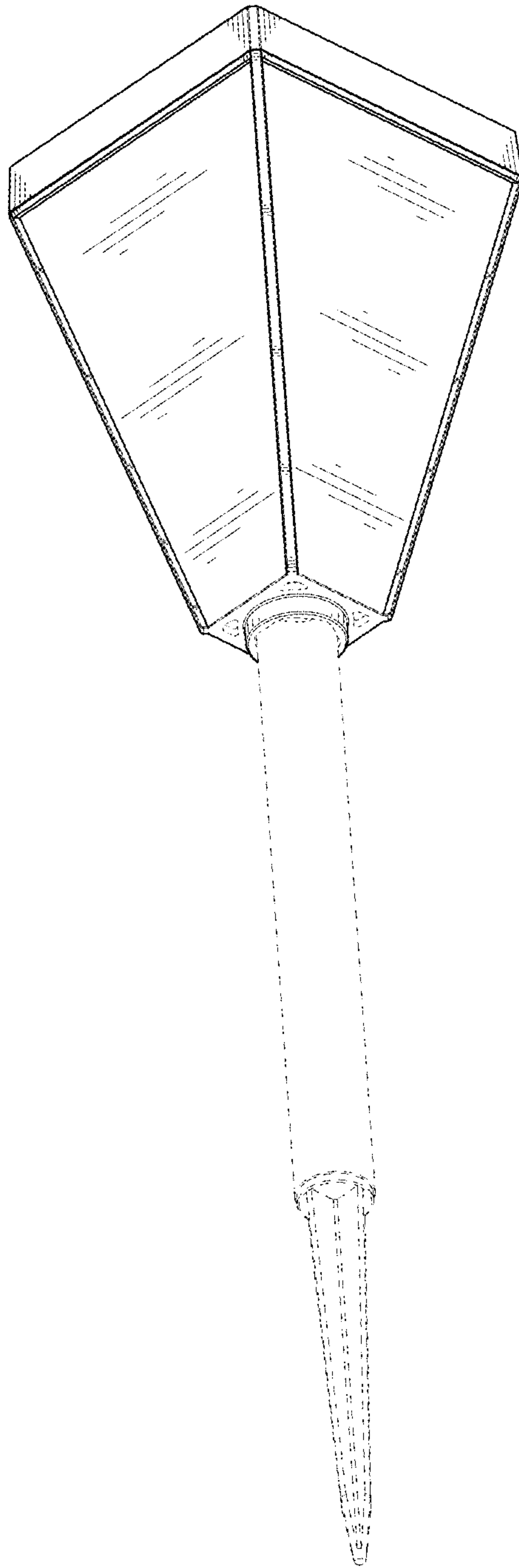

FIG. 2

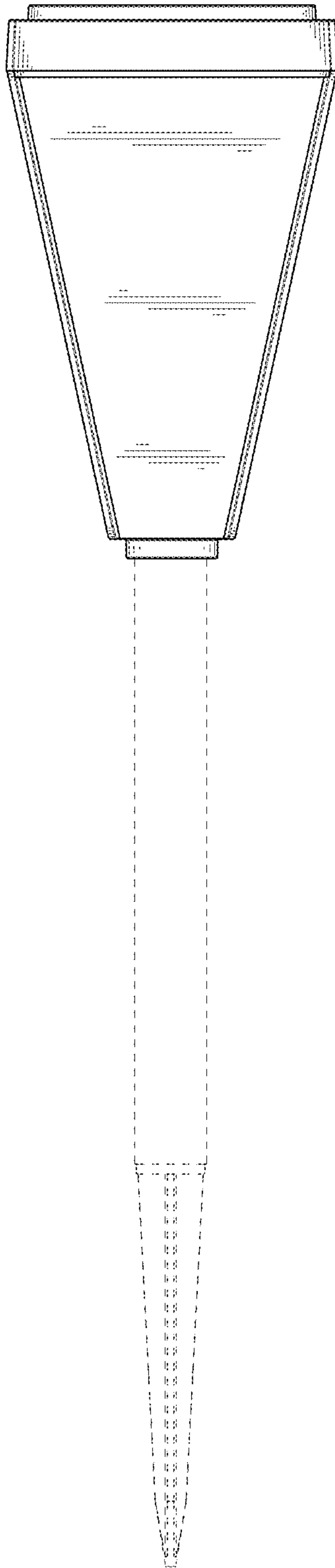

FIG. 3

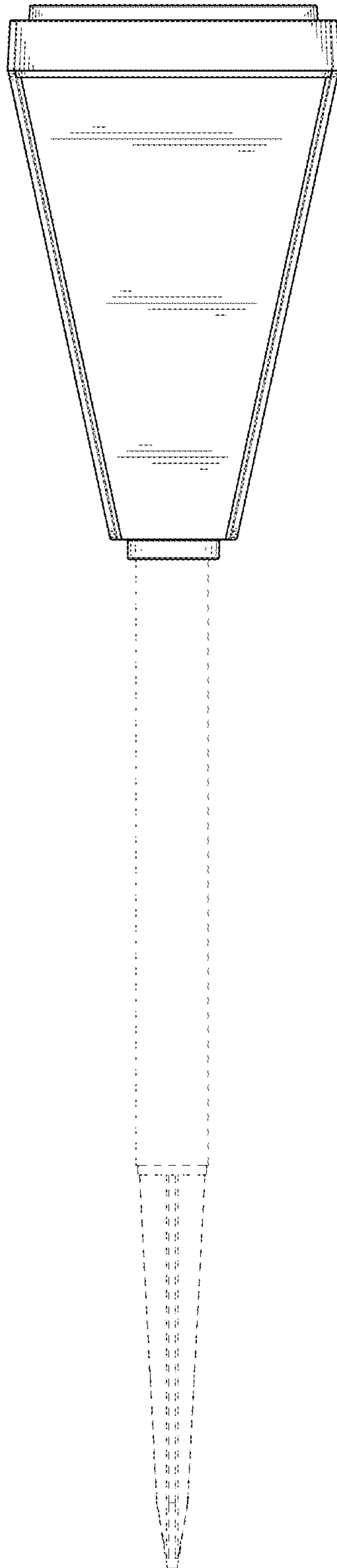

FIG. 4

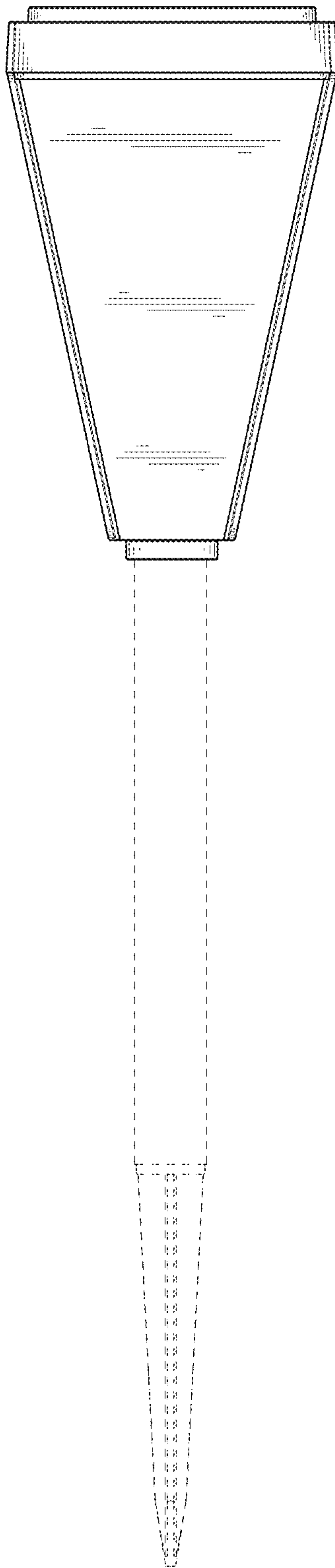

FIG. 5

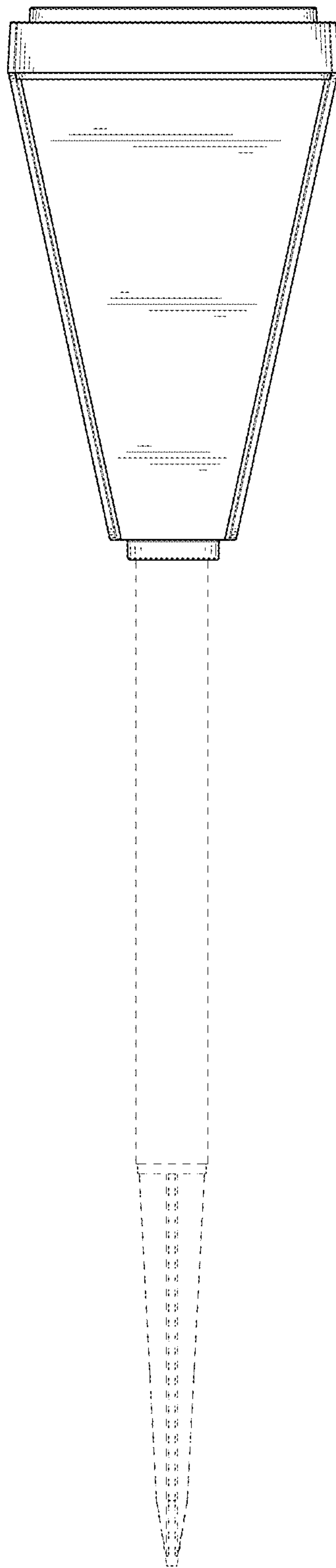

FIG. 6

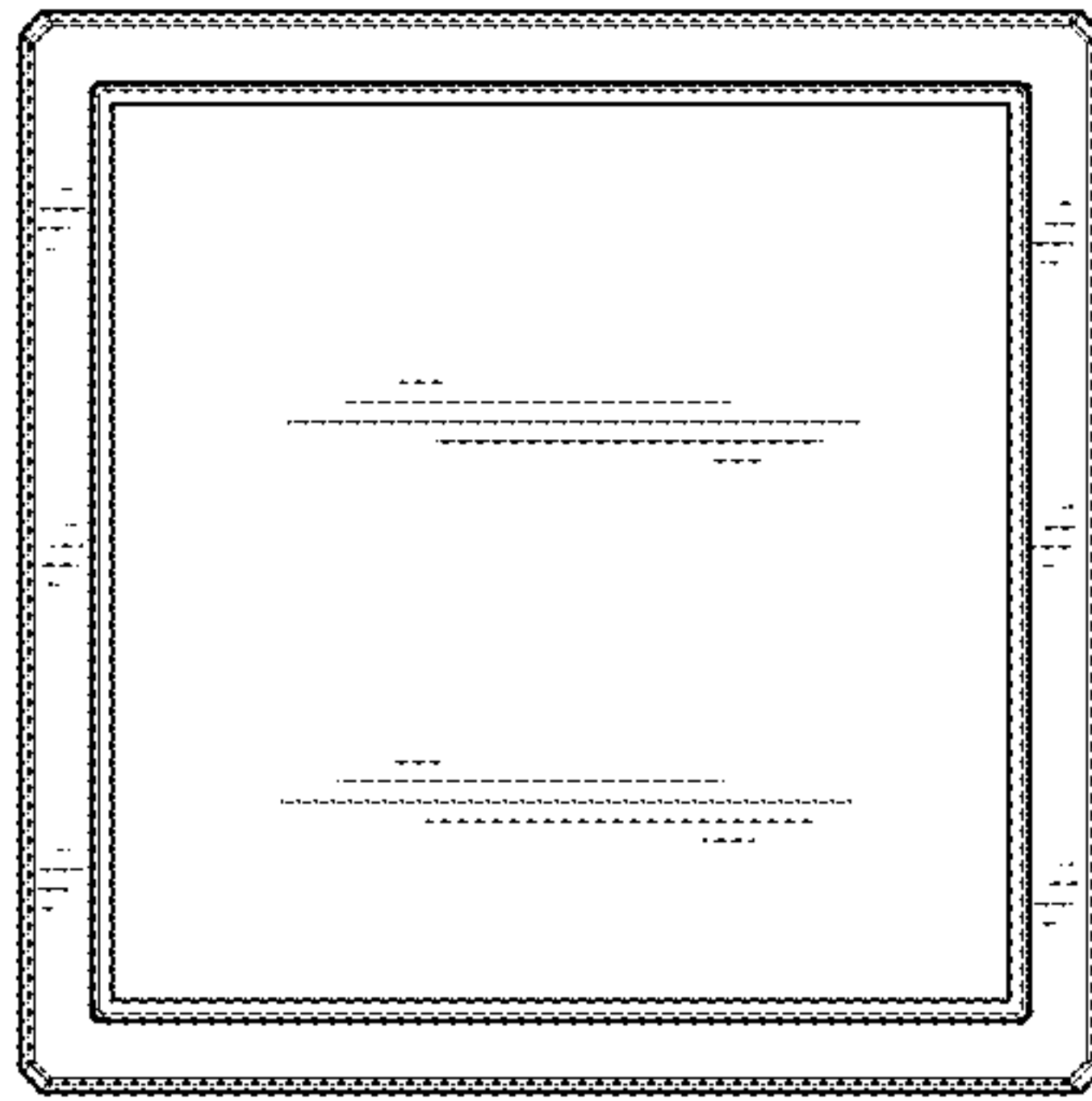

FIG. 7

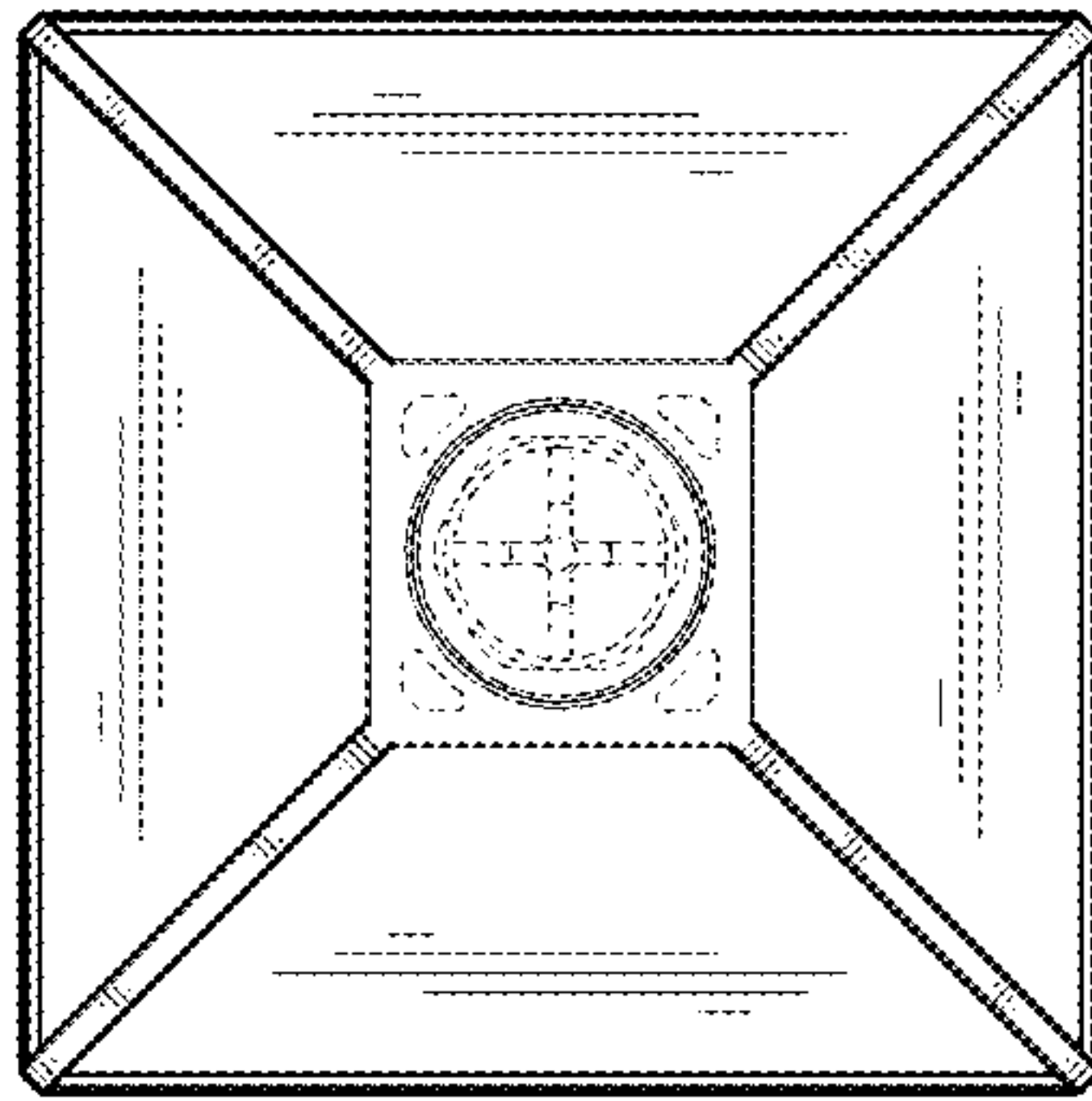

FIG. 8