



US00D978302S

(12) **United States Design Patent**
Fu et al.

(10) **Patent No.: US D978,302 S**

(45) **Date of Patent: ** Feb. 14, 2023**

(54) **TOILET LADDER**

(56) **References Cited**

(71) Applicant: **ZHEJIANG YIWU SHUMEIJIA TECHNOLOGY SHARE CO., LTD,**
Yiwu (CN)

U.S. PATENT DOCUMENTS

D346,206 S *	4/1994	Crossley	D23/296
D570,461 S *	6/2008	Desnos-Simon	D23/296
D594,564 S *	6/2009	Disch	D25/69
D618,321 S *	6/2010	Yeung	D23/296
D904,584 S *	12/2020	Stroikov	D23/296
D962,663 S *	9/2022	Chen	D6/350

(72) Inventors: **Junrong Fu**, Jinhua (CN); **Jiajian Fu**,
Yiwu (CN); **Yanwen Luo**, Jinhua (CN);
Huan Sun, Suzhou (CN)

* cited by examiner

(73) Assignee: **ZHEJIANG YIWU SHUMEIJIA TECHNOLOGY SHARE CO., LTD,**
Yiwu (CN)

Primary Examiner — Robert A Delehanty

(74) *Attorney, Agent, or Firm* — Georgi Korobanov

(**) Term: **15 Years**

(57) **CLAIM**

(21) Appl. No.: **29/845,874**

The ornamental design for a toilet ladder, as shown and described.

(22) Filed: **Jul. 11, 2022**

DESCRIPTION

(30) **Foreign Application Priority Data**

Mar. 10, 2022 (CN) 202230122422.1

(51) **LOC (14) Cl.** **23-02**

(52) **U.S. Cl.**
USPC **D23/296**

(58) **Field of Classification Search**
USPC D23/296, 309, 311; D6/339, 350;
D25/65

FIG. 1 is a perspective view of a toilet ladder, showing our new design;
FIG. 2 is another perspective view thereof;
FIG. 3 is a front view thereof;
FIG. 4 is a rear view thereof;
FIG. 5 is a left side view thereof;
FIG. 6 is a right side view thereof;
FIG. 7 is a top plan view thereof; and,
FIG. 8 is a bottom plan view thereof.

See application file for complete search history.

1 Claim, 8 Drawing Sheets

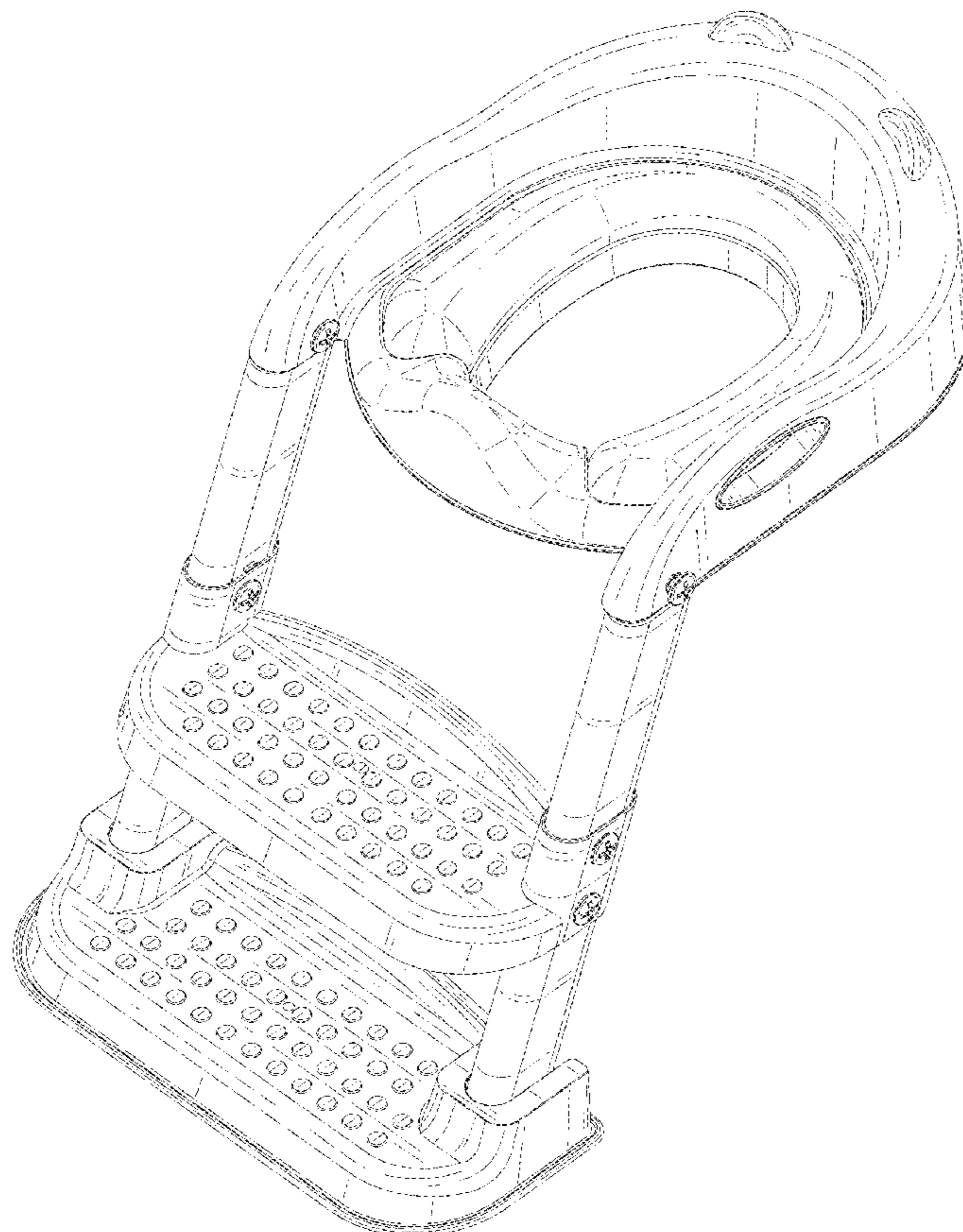

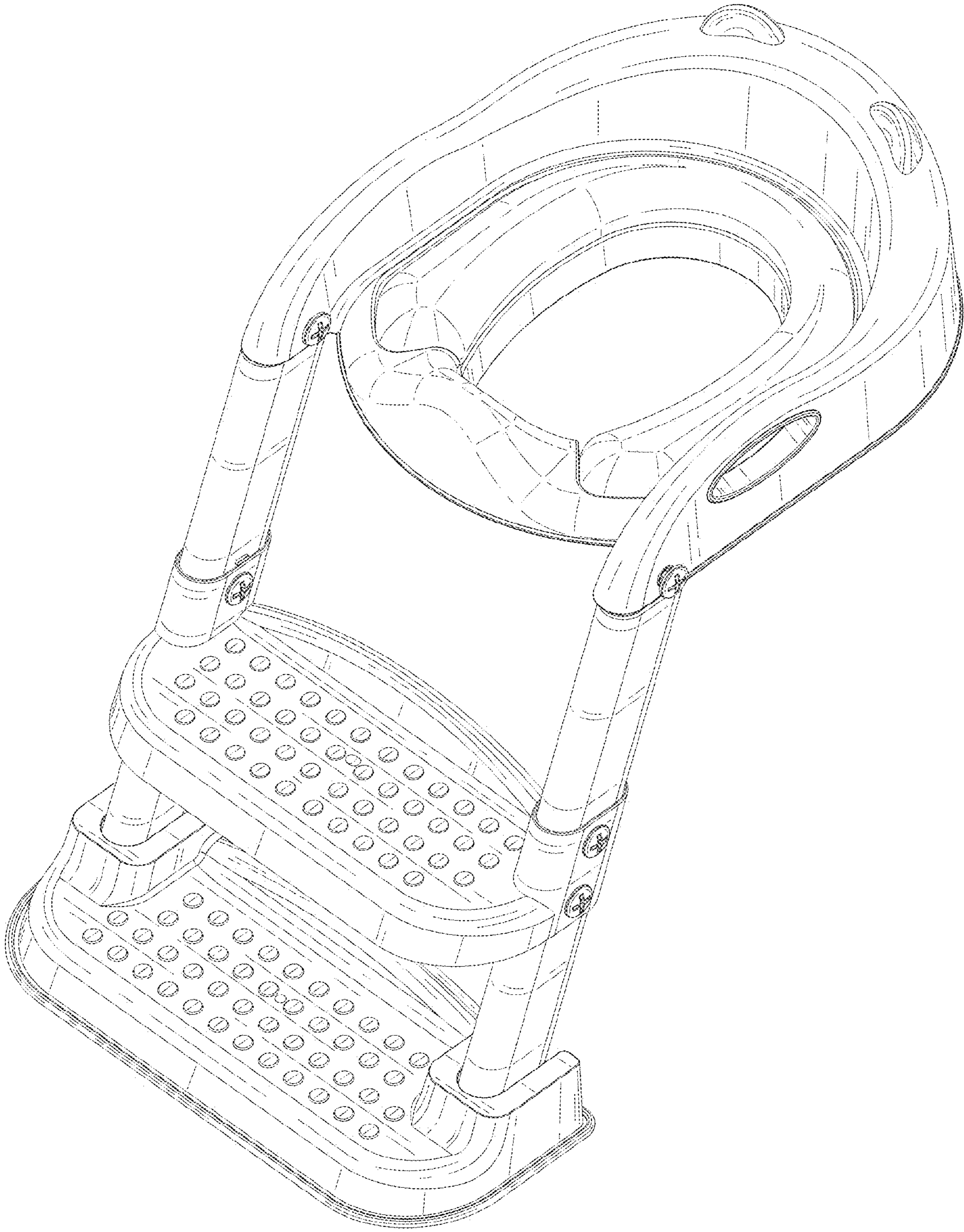

FIG. 1

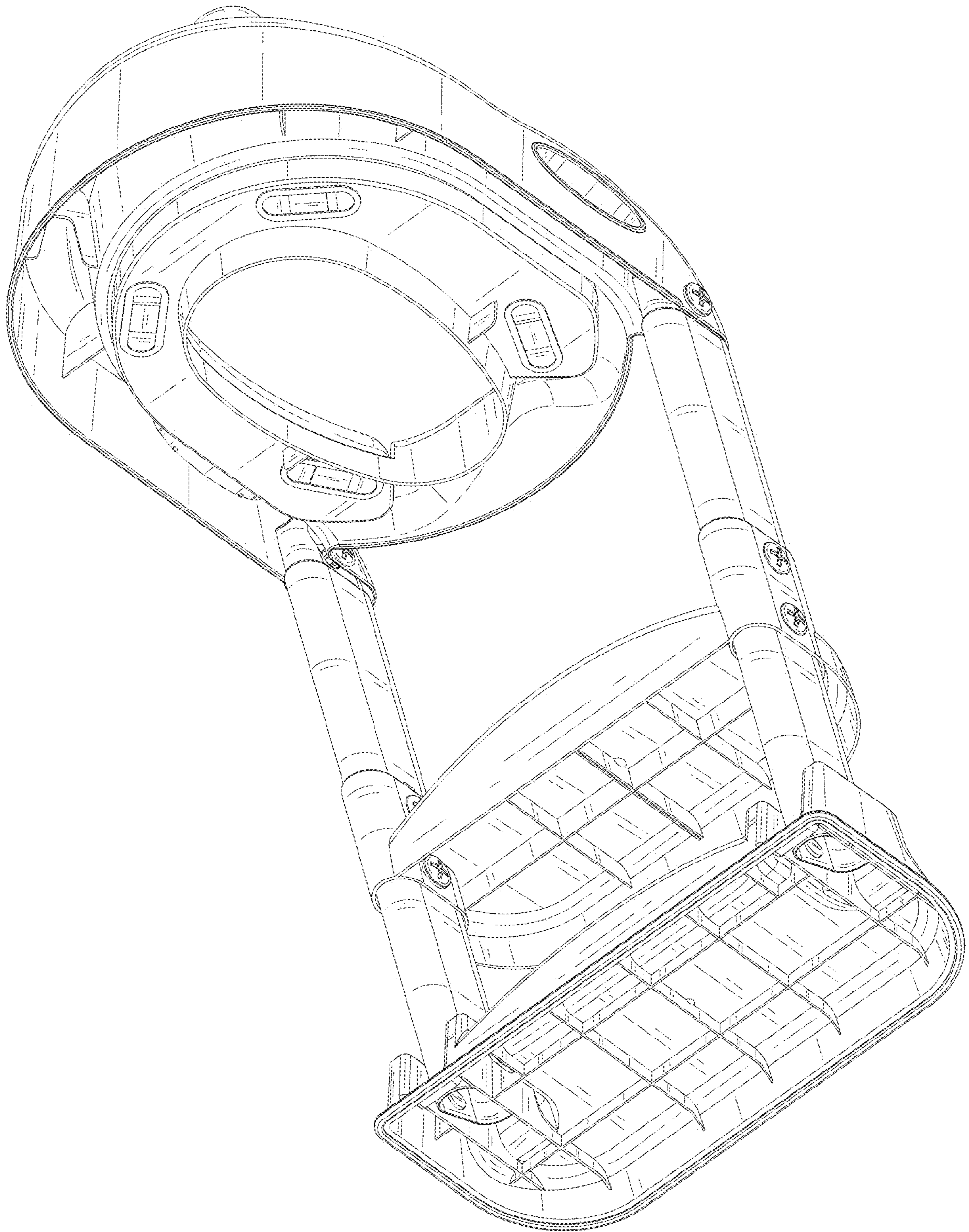

FIG. 2

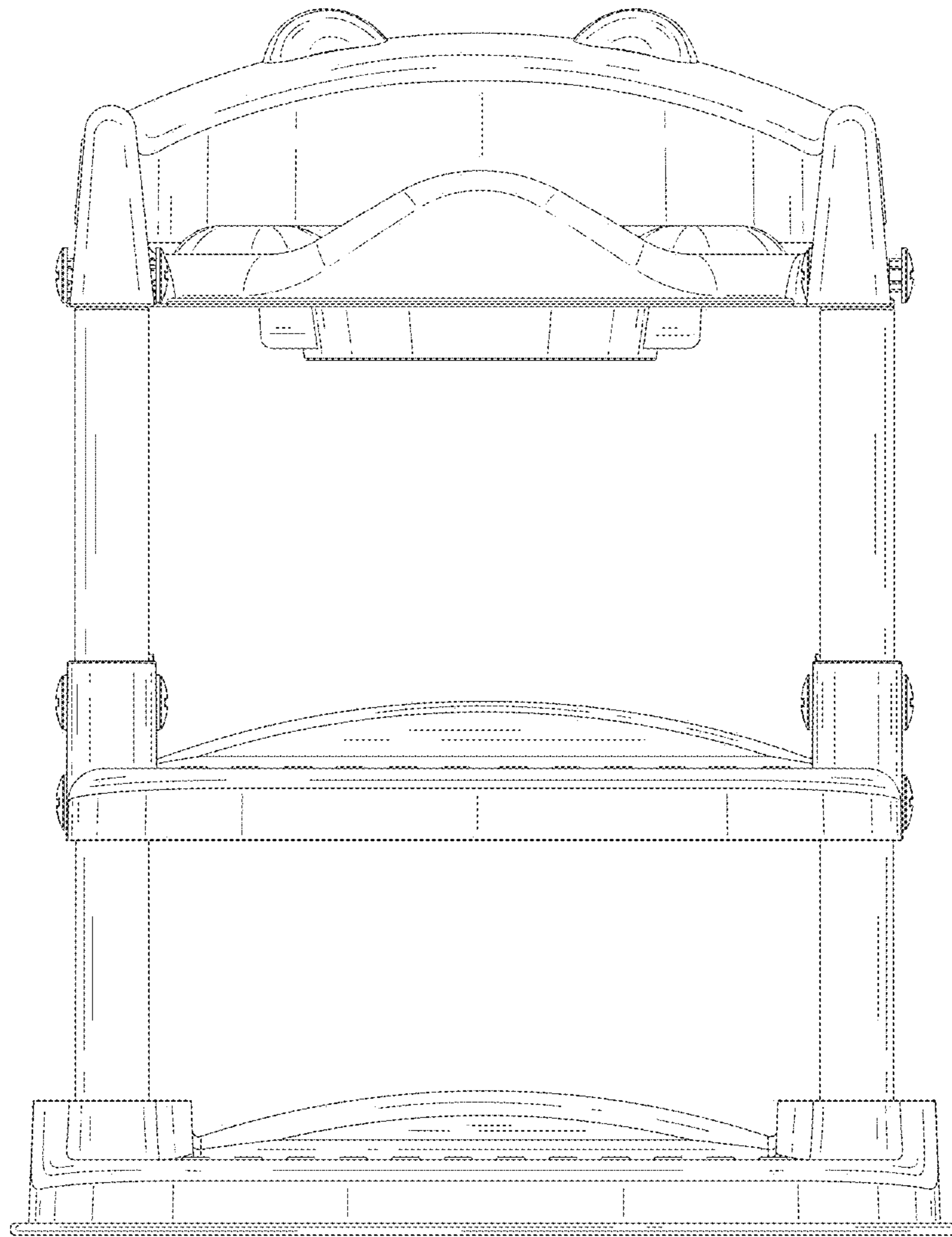

FIG. 3

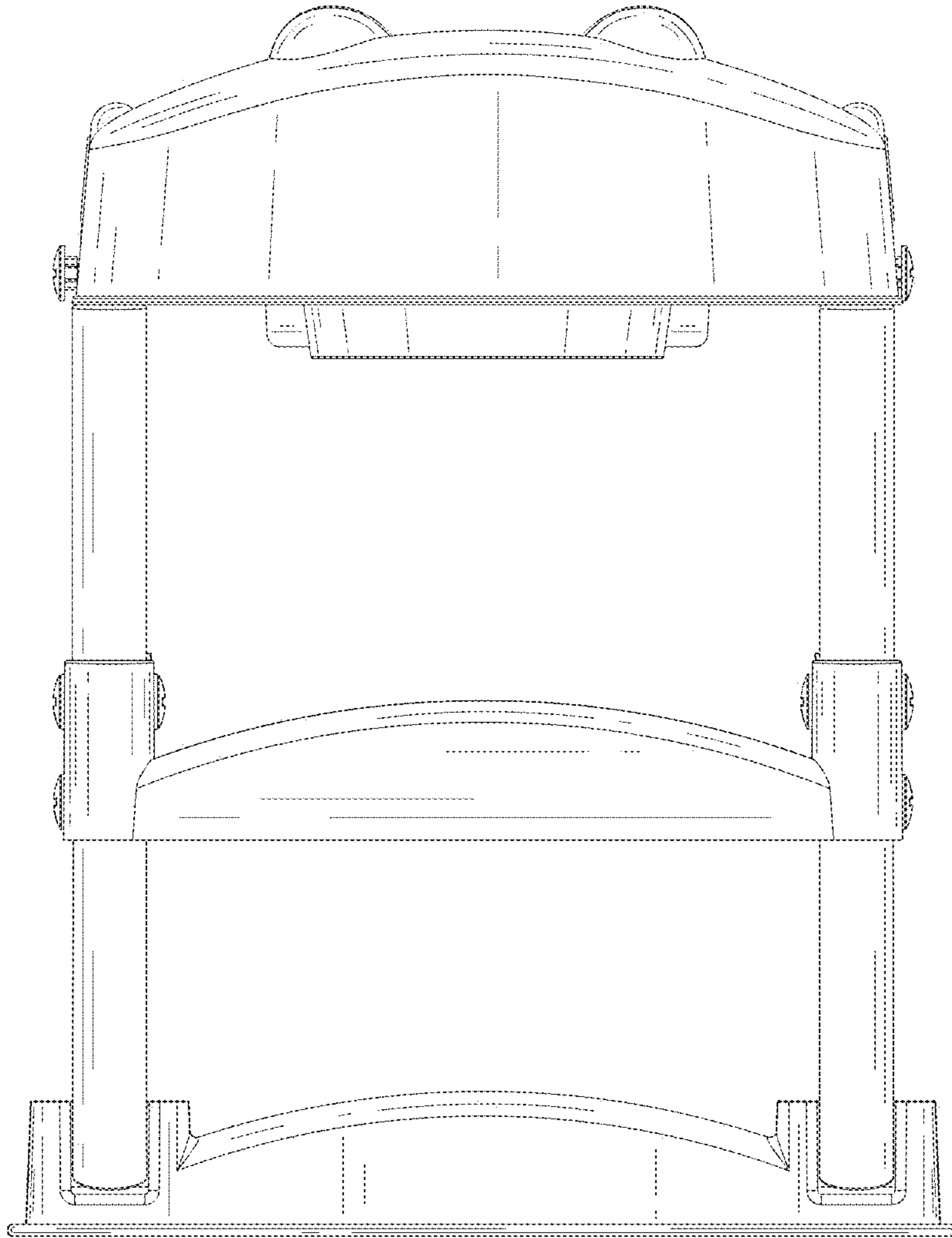

FIG. 4

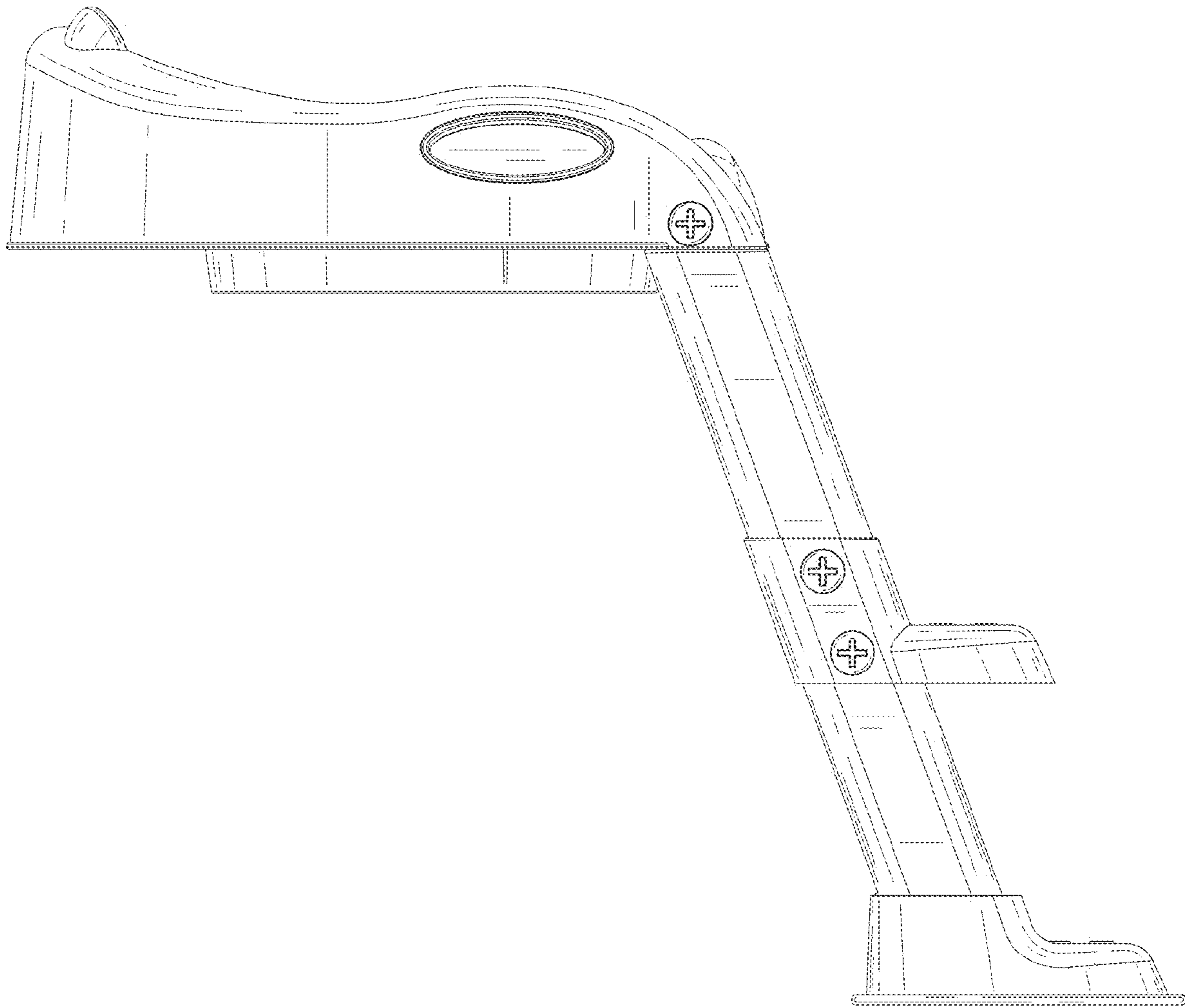

FIG. 5

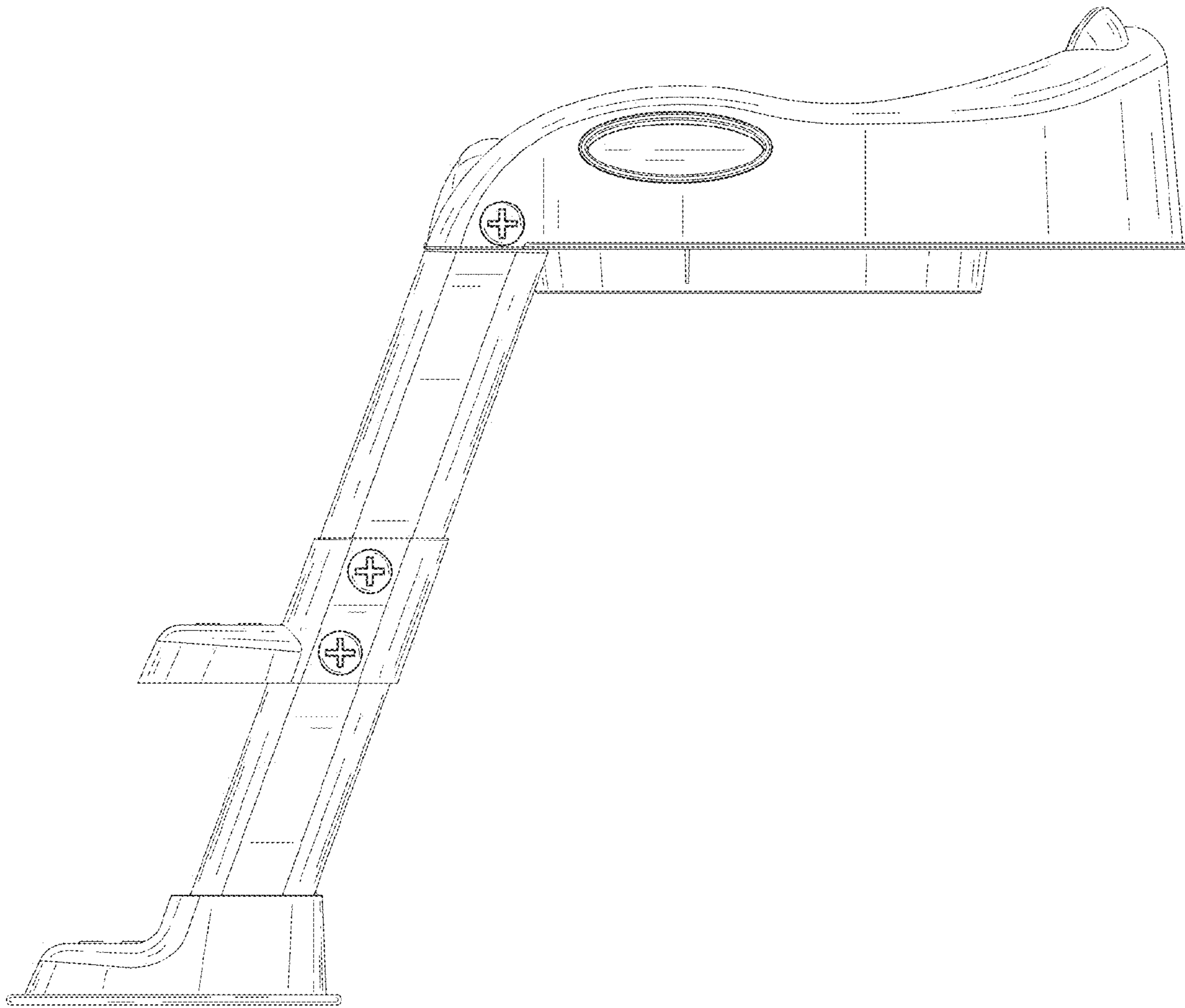

FIG. 6

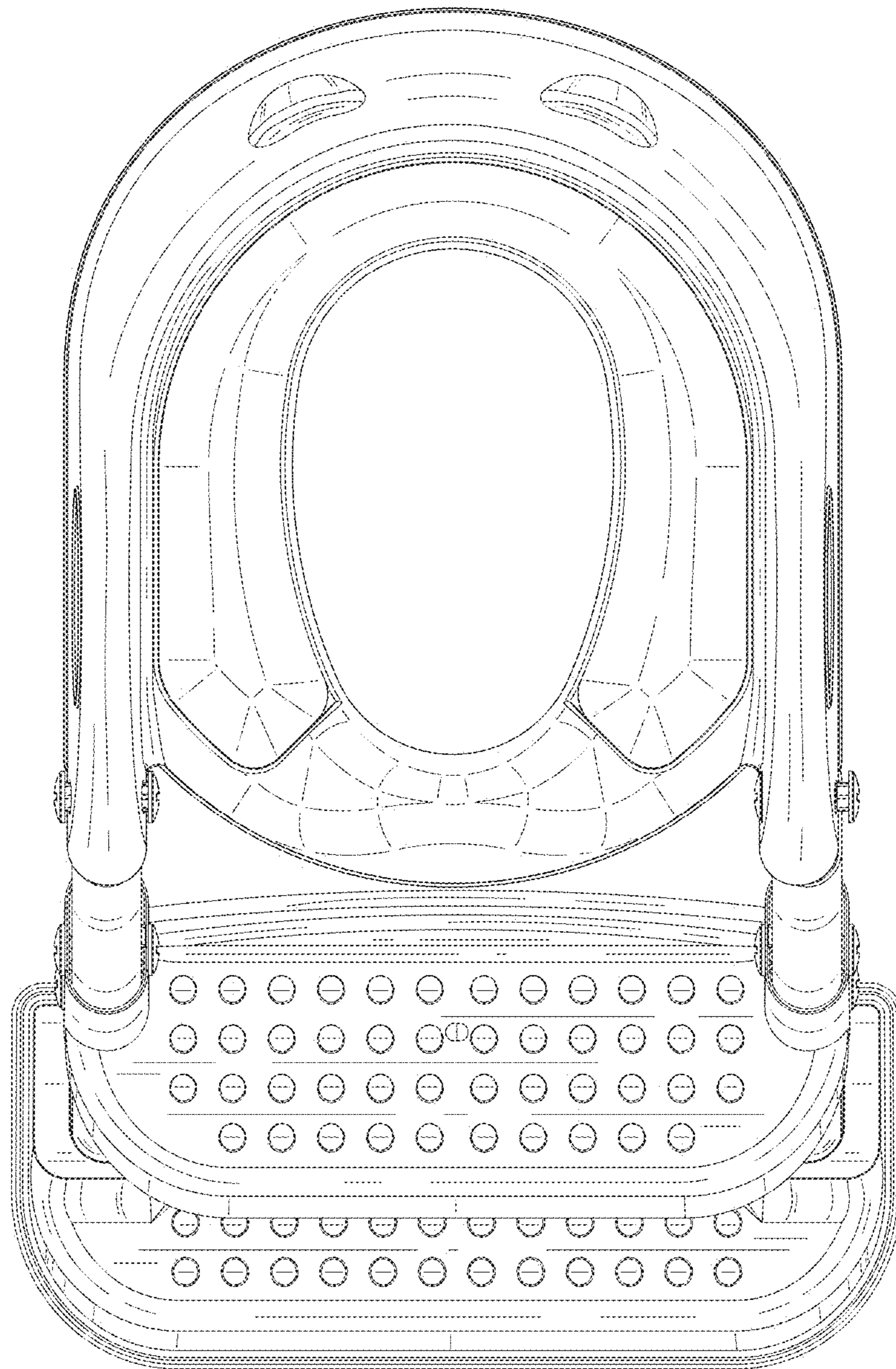

FIG. 7

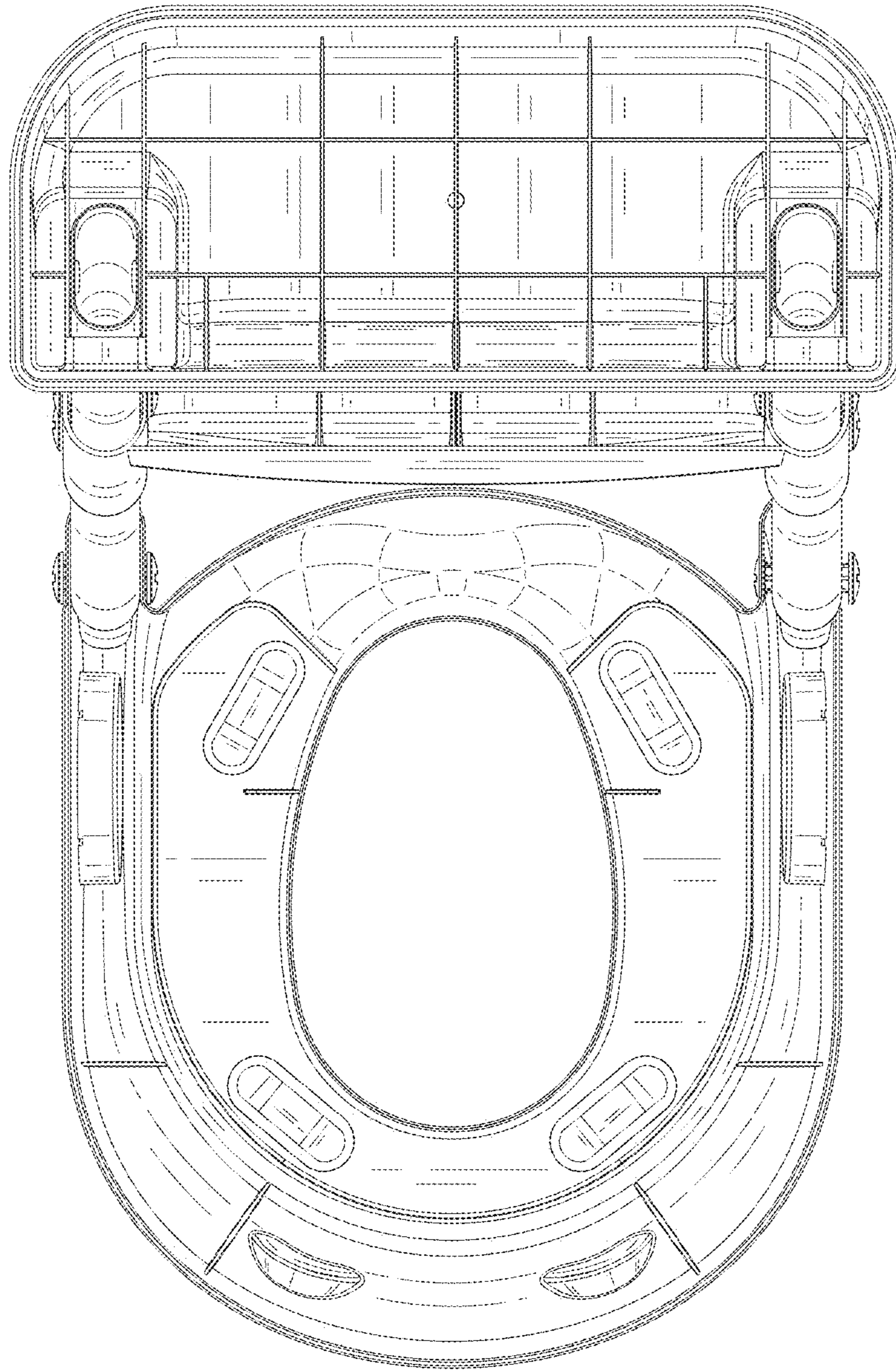

FIG. 8