



US00D978249S

(12) **United States Design Patent**  
**Urban et al.**

(10) **Patent No.:** **US D978,249 S**

(45) **Date of Patent:** **\*\* Feb. 14, 2023**

(54) **GAMING MACHINE**

(71) Applicant: **Aristocrat Technologies, Inc.**, Las Vegas, NV (US)

(72) Inventors: **Bruce Urban**, Las Vegas, NV (US);  
**Ariel Turgel**, San Francisco, CA (US);  
**Wei Gu**, Daly City, CA (US); **Daniel Harden**, Palo Alto, CA (US)

(73) Assignee: **Aristocrat Technologies, Inc.**, Las Vegas, NV (US)

(\*\*) Term: **15 Years**

(21) Appl. No.: **29/750,196**

(22) Filed: **Sep. 11, 2020**

(51) **LOC (14) Cl.** ..... **21-03**

(52) **U.S. Cl.**  
USPC ..... **D21/369**

(58) **Field of Classification Search**  
USPC ..... D21/329, 332, 333, 365, 385, 694, 371,  
D21/325, 324, 336, 369; D14/307, 308,  
D14/302

See application file for complete search history.

(56) **References Cited**

**U.S. PATENT DOCUMENTS**

D415,124 S	*	10/1999	Rooyackers	.....	D14/306
D481,078 S	*	10/2003	Stephan	.....	D21/369
D554,708 S		11/2007	Gutknecht		
D560,725 S	*	1/2008	Johnson	.....	D21/370
D599,859 S		9/2009	Lesley		
D603,909 S		11/2009	De Viveiros Ortiz		
D615,598 S		5/2010	McComb		
D677,736 S		3/2013	Dorn		
D697,558 S		1/2014	Myers		
D727,431 S		4/2015	Themann		
D732,520 S		6/2015	Themann		
D848,534 S		5/2019	Calhoun		
D849,150 S		5/2019	Gallagher		

D854,621 S		7/2019	Calhoun		
D858,642 S		9/2019	Legras		
D865,066 S	*	10/2019	Ortiz De Viveiros	.....	D21/369
D865,873 S		11/2019	Lewis		
D866,667 S		11/2019	Stair		

(Continued)

**OTHER PUBLICATIONS**

Office Action dated Jun. 23, 2022 for U.S. Appl. No. 29/750,136 (pp. 1-8).

(Continued)

*Primary Examiner* — Khawaja Anwar

*Assistant Examiner* — Julice Seung Eun Oum

(74) *Attorney, Agent, or Firm* — Armstrong Teasdale LLP

(57) **CLAIM**

We claim the ornamental design for a gaming machine, as shown and described.

**DESCRIPTION**

FIG. 1 is a front perspective view of a gaming machine showing our new design;

FIG. 2 is a front view of the gaming machine shown in FIG. 1;

FIG. 3 is a back view of the gaming machine shown in FIG. 1;

FIG. 4 is a right side view of the gaming machine shown in FIG. 1;

FIG. 5 is a left side view of the gaming machine shown in FIG. 1; and,

FIG. 6 is a top view of the gaming machine shown in FIG. 1.

In these drawings, the solid lines illustrate the claimed ornamental design, whereas the broken lines illustrate unclaimed environmental features and form no part of the claimed design.

**1 Claim, 6 Drawing Sheets**

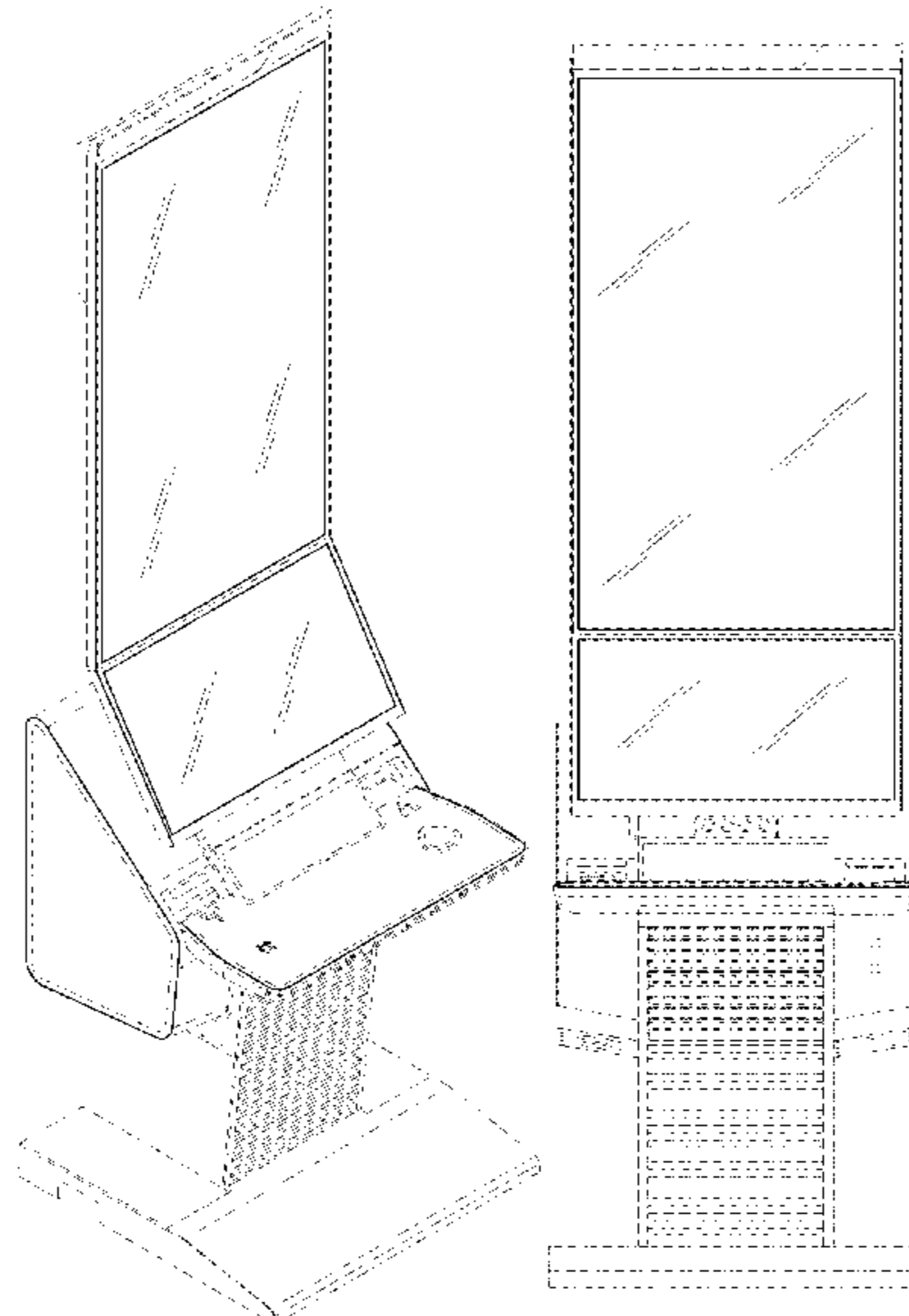

(56)

**References Cited**

U.S. PATENT DOCUMENTS

D889,553	S	*	7/2020	Glenn, II	.....	D21/369
D889,554	S		7/2020	Calhoun Lewis		
D890,850	S		7/2020	Johnson		
D893,628	S		8/2020	Thoeni		
D894,285	S		8/2020	Glenn, II		
D907,710	S	*	1/2021	DeMarco	.....	D21/369
D907,716	S	*	1/2021	DeMarco	.....	D21/369
D910,119	S	*	2/2021	DeMarco	.....	D21/369
D910,762	S		2/2021	Demarco		
D913,379	S		3/2021	Calhoun		
D943,028	S	*	2/2022	Ortiz de Viveiros	.....	D21/369
D946,661	S	*	3/2022	Thompson	.....	D21/369
D948,621	S		4/2022	Jadeja		
D951,359	S	*	5/2022	Lawson	.....	D21/370
2002/0065132	A1	*	5/2002	Stephan	.....	G07F 17/3216 463/47
2007/0238511	A1		10/2007	Sato		
2013/0303265	A1		11/2013	Wilkins		
2014/0274292	A1		9/2014	Suda		
2015/0262449	A1	*	9/2015	Meyer	.....	G07F 17/34 463/20
2020/0051374	A1		2/2020	Solaja		
2020/0051377	A1		2/2020	Montenegro		
2021/0035402	A1		2/2021	Rye		
2021/0110642	A1	*	4/2021	Ocampo	.....	G07F 17/3211
2021/0366236	A1	*	11/2021	Soong	.....	G07F 17/3211

OTHER PUBLICATIONS

Office Action dated Jun. 23, 2022 for U.S. Appl. No. 29/750,137 (pp. 1-8).

\* cited by examiner

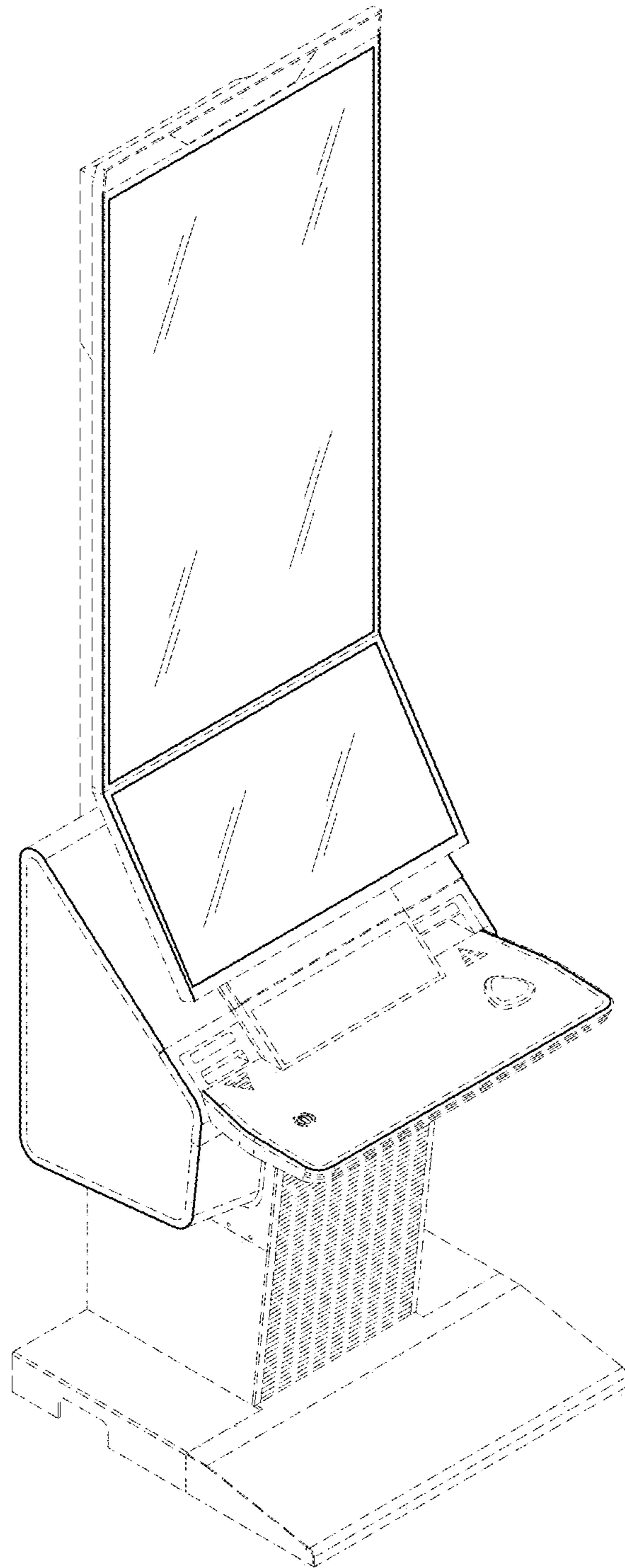

FIG. 1

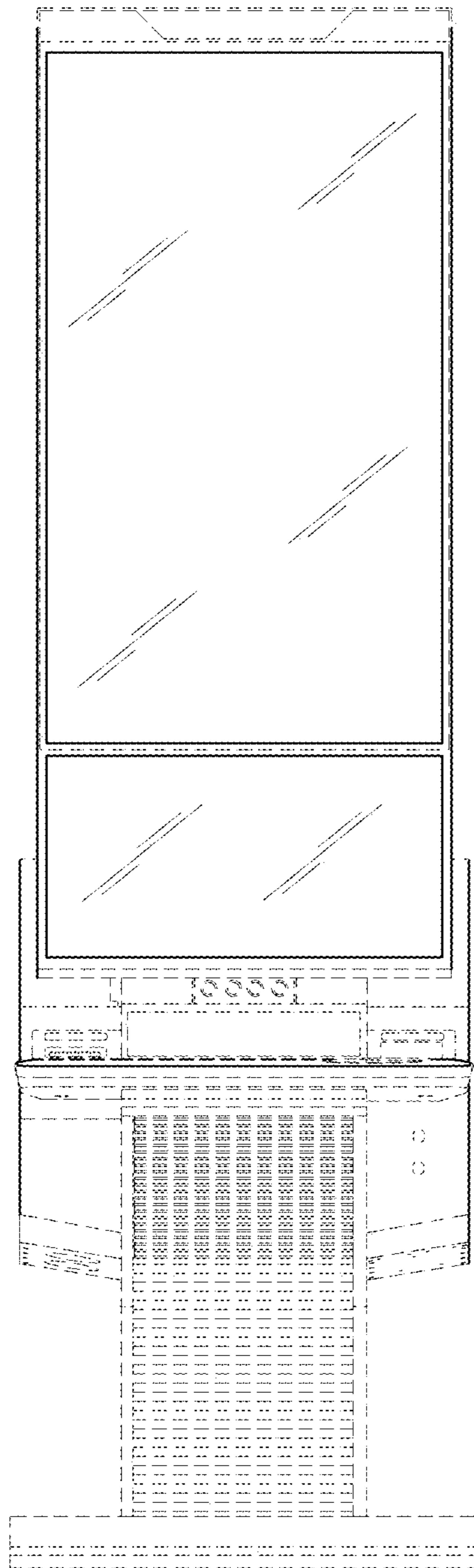

FIG. 2

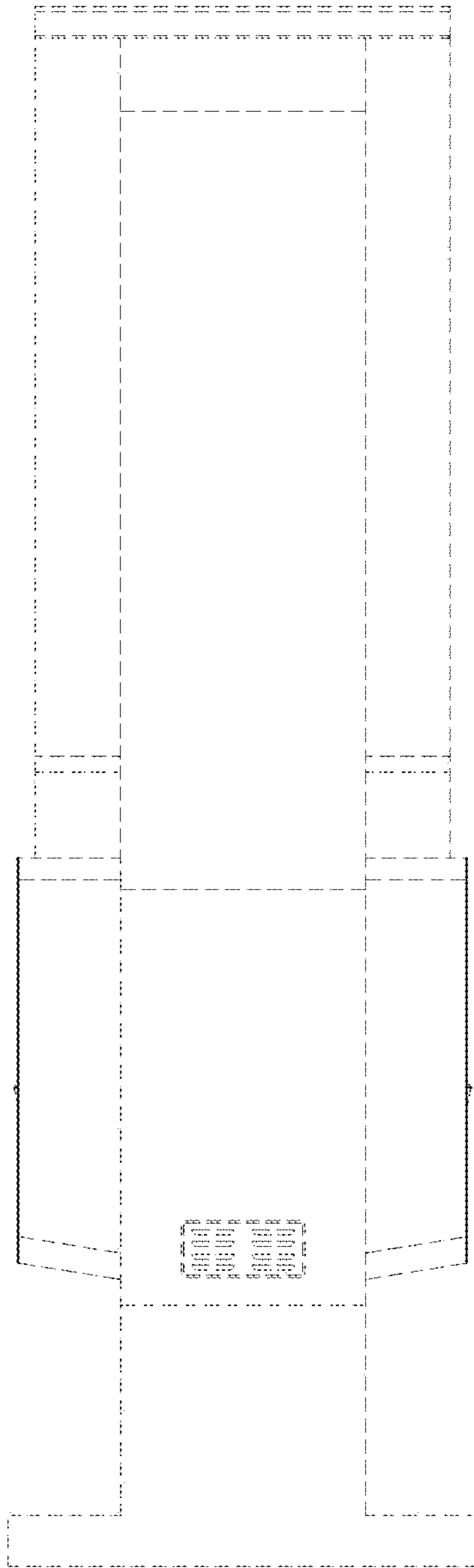

FIG. 3

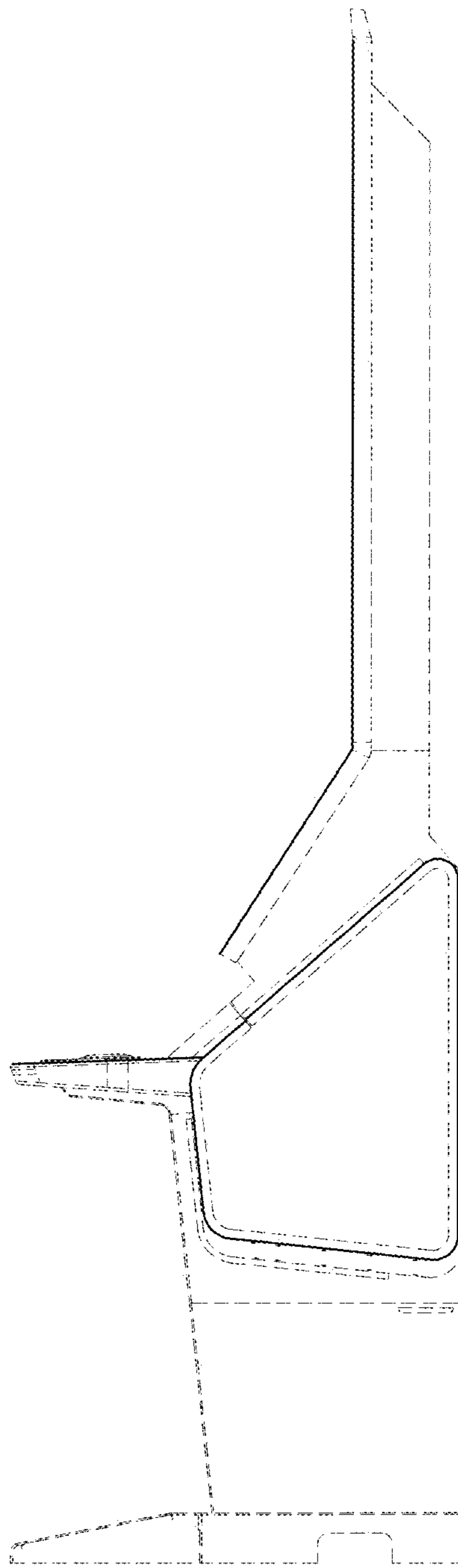

FIG. 4

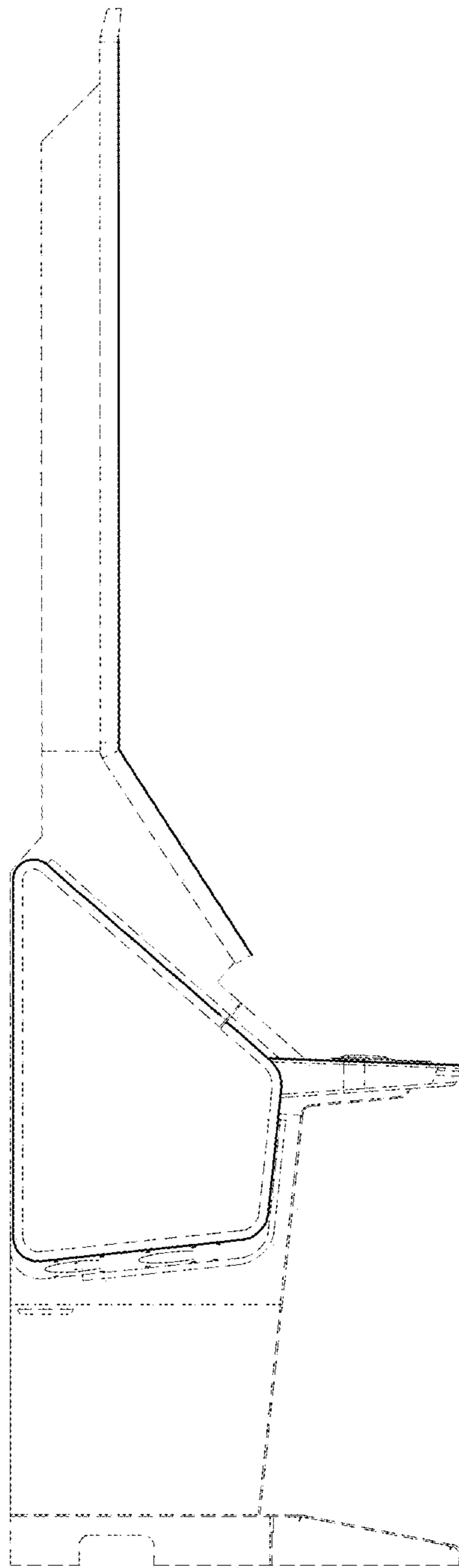

FIG. 5

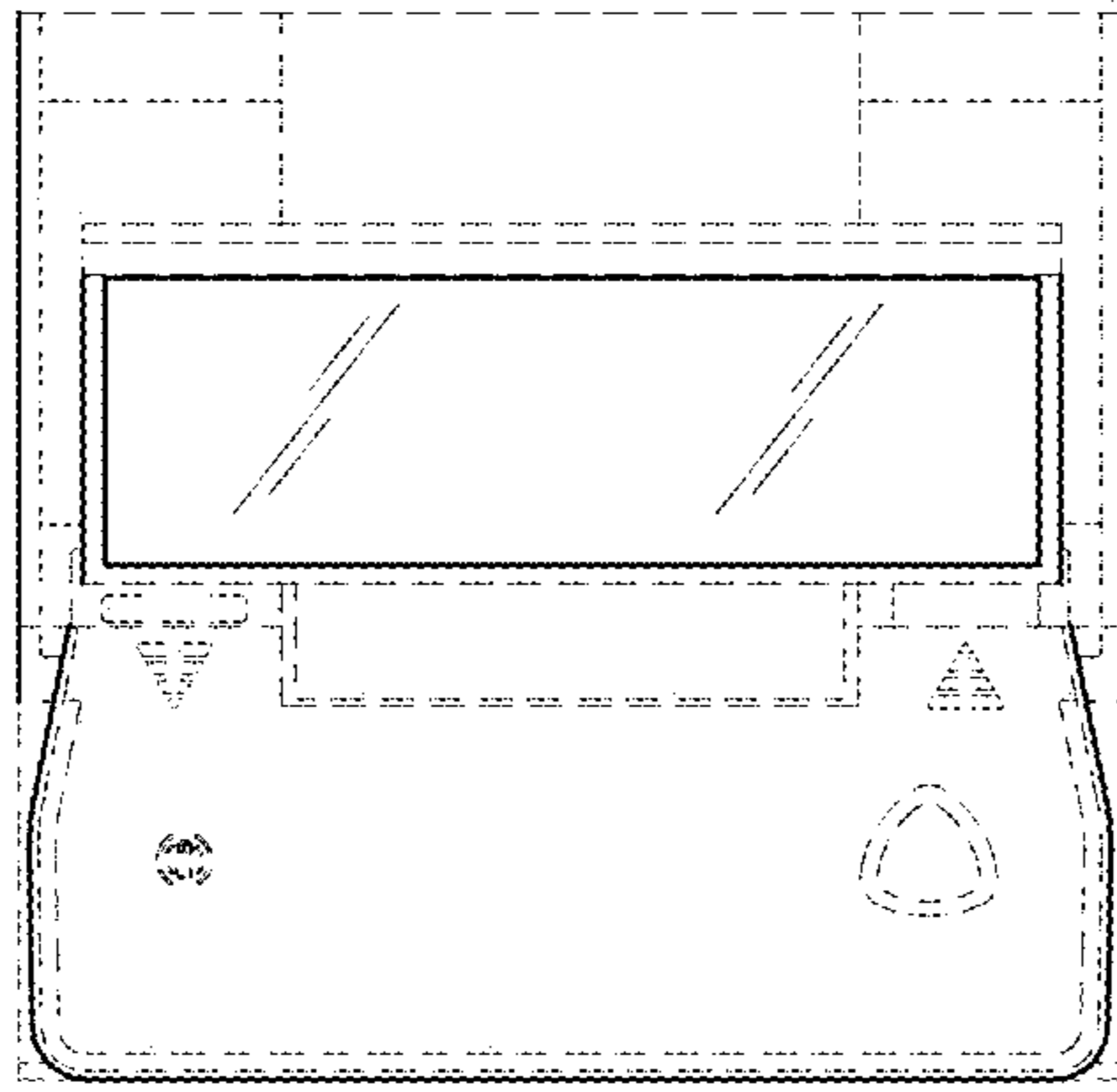

FIG. 6