



US00D978222S

(12) **United States Design Patent** (10) **Patent No.:** **US D978,222 S**
Li (45) **Date of Patent:** **** Feb. 14, 2023**

(54) **PROJECTOR**

(71) Applicant: **HONGKONG BAI CHUANG**
E-COMMERCE LIMITED, Kowloon
(CN)

(72) Inventor: **Ling Li**, Kowloon (CN)

(**) Term: **15 Years**

(21) Appl. No.: **29/747,714**

(22) Filed: **Aug. 25, 2020**

(51) **LOC (14) Cl.** **16-02**

(52) **U.S. Cl.**
USPC **D16/225; D16/230**

(58) **Field of Classification Search**
USPC D16/221, 225, 230–231, 234, 208;
D21/514; D14/138 AA, 138 R, 474
CPC G03B 21/001; G03B 21/003; G03B 21/00;
G03B 21/14; G03B 21/145; G03B 21/16
See application file for complete search history.

(56) **References Cited**

U.S. PATENT DOCUMENTS

D600,735 S * 9/2009 Chigira D16/230
D645,491 S * 9/2011 Lee D16/225

D666,661 S * 9/2012 Hong D16/230
D691,189 S * 10/2013 Zhao D16/230
D808,455 S * 1/2018 Lee D16/202
D860,290 S * 9/2019 Lee D16/208
2014/0016295 A1* 1/2014 Huang G03B 21/145
361/827

* cited by examiner

Primary Examiner — Wan Laymon

(74) *Attorney, Agent, or Firm* — Rumit Ranjit Kanakia

(57) **CLAIM**

The ornamental design for a projector, as shown and described.

DESCRIPTION

FIG. 1 is a perspective view of a projector showing my new design;
FIG. 2 is a front view thereof;
FIG. 3 is a back view thereof;
FIG. 4 is a right-side view thereof;
FIG. 5 is a left-side view thereof;
FIG. 6 is a top view thereof; and,
FIG. 7 is a bottom view thereof.
The broken lines are for the purpose of illustrating portions of the article that form no part of the claim.

1 Claim, 7 Drawing Sheets

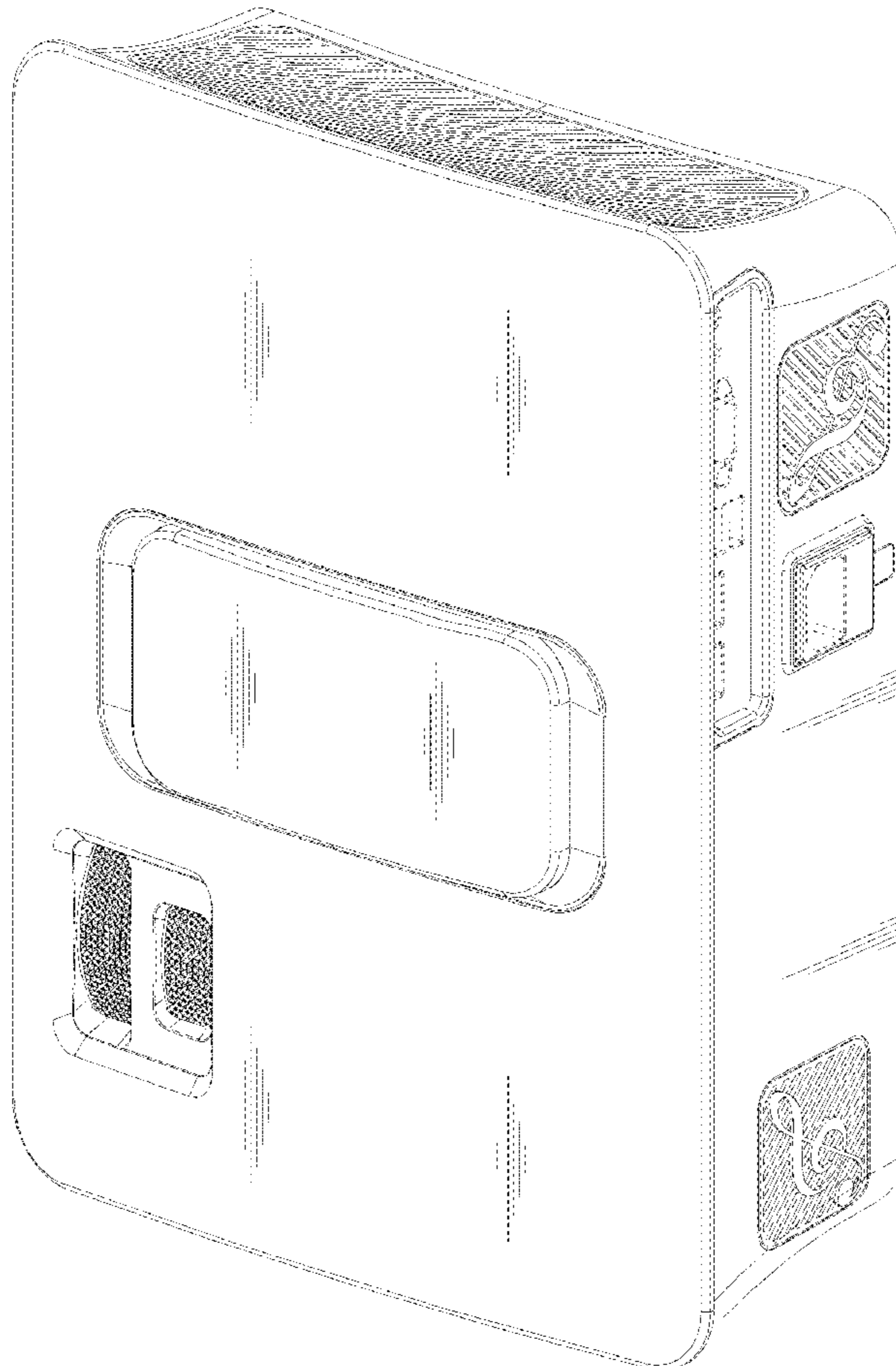

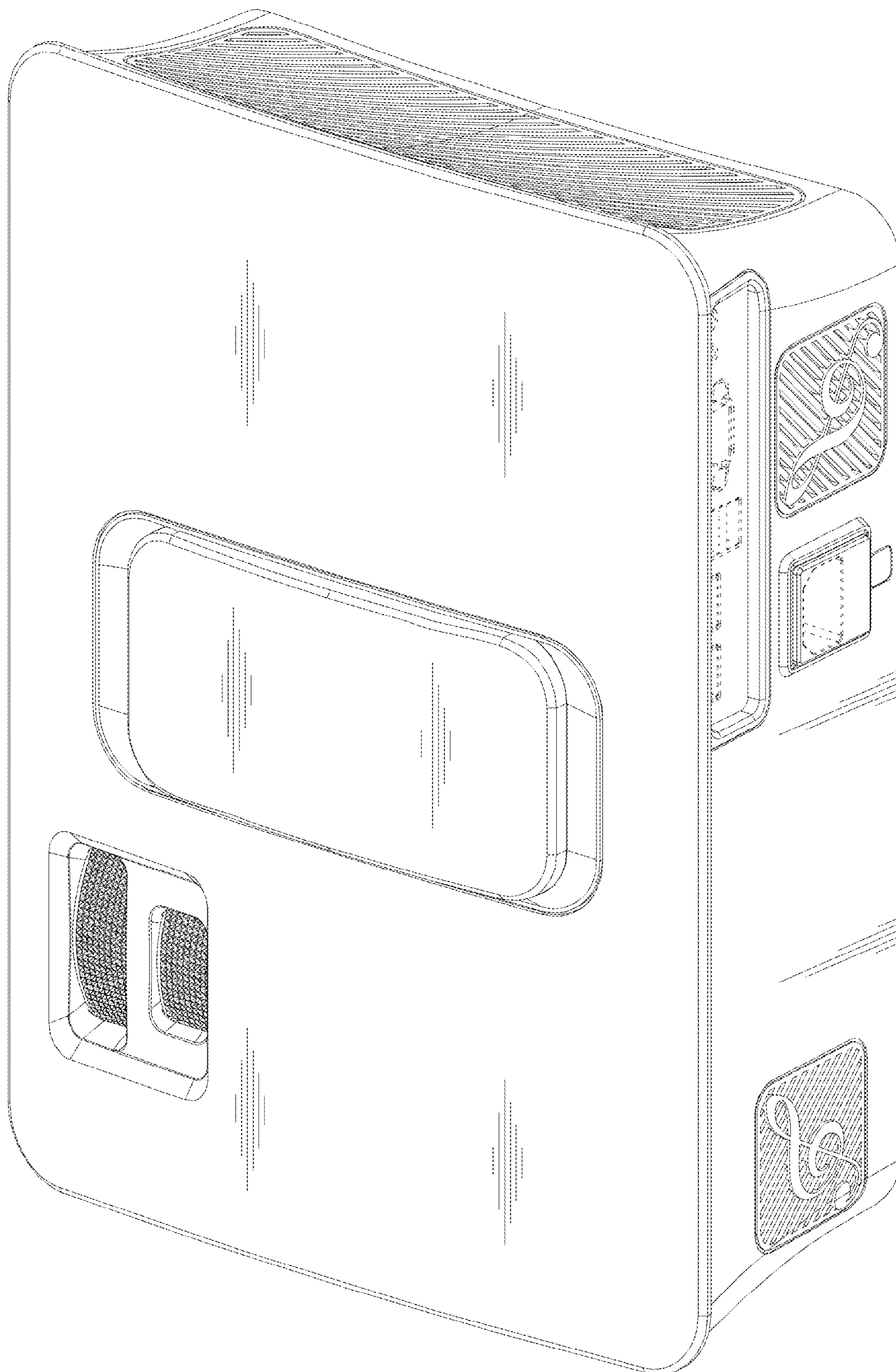

FIG. 1

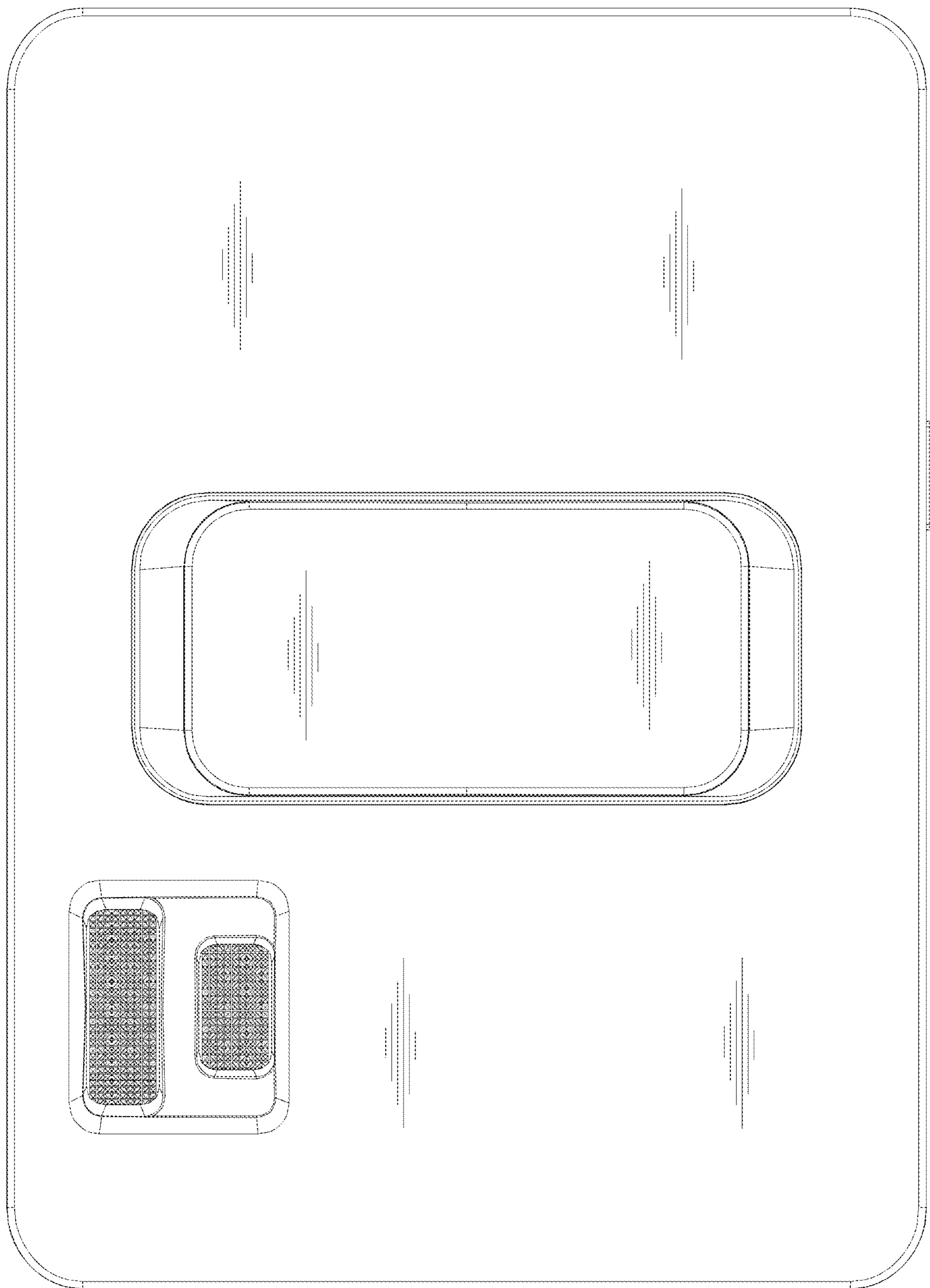

FIG. 2

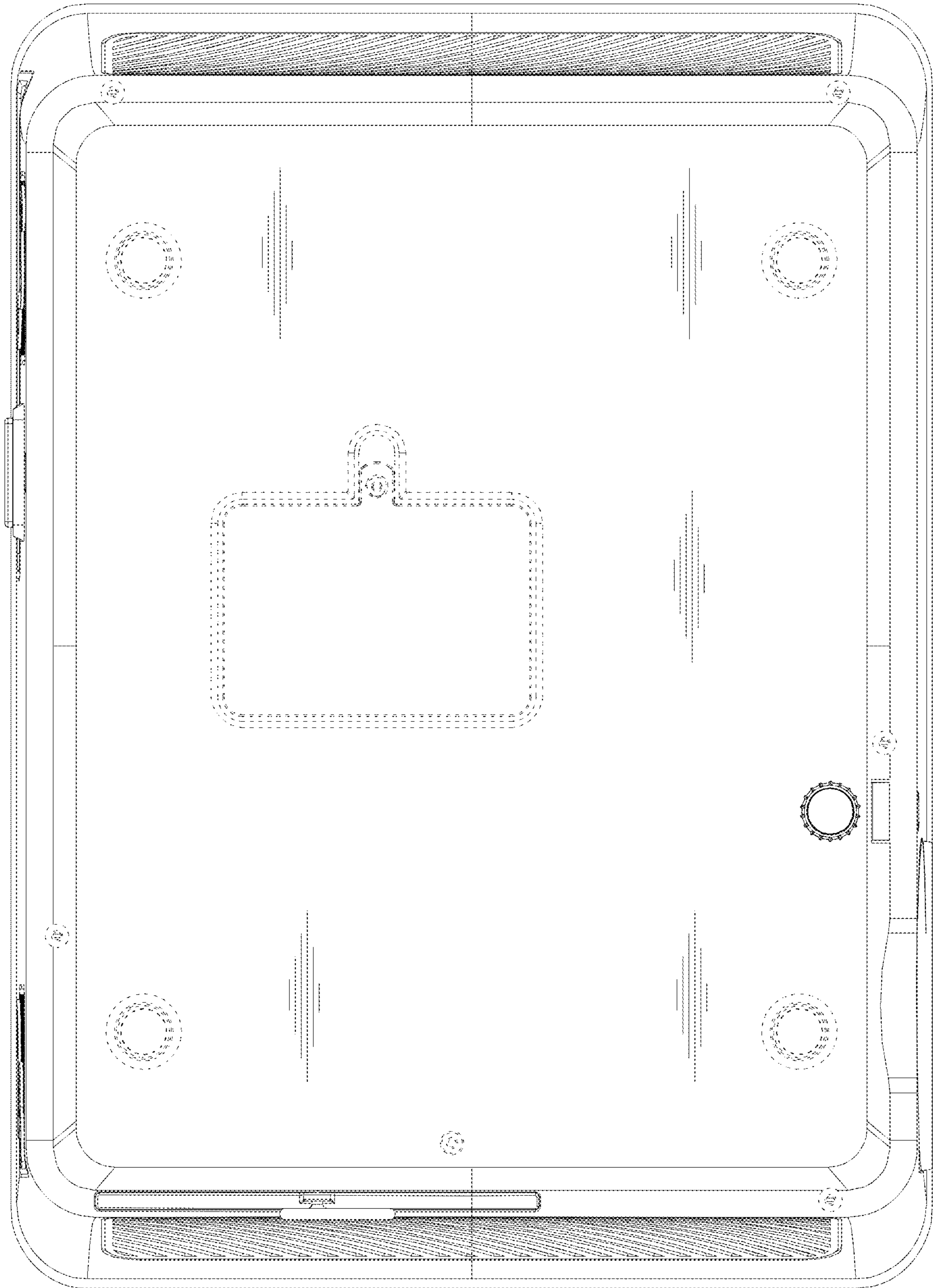

FIG. 3

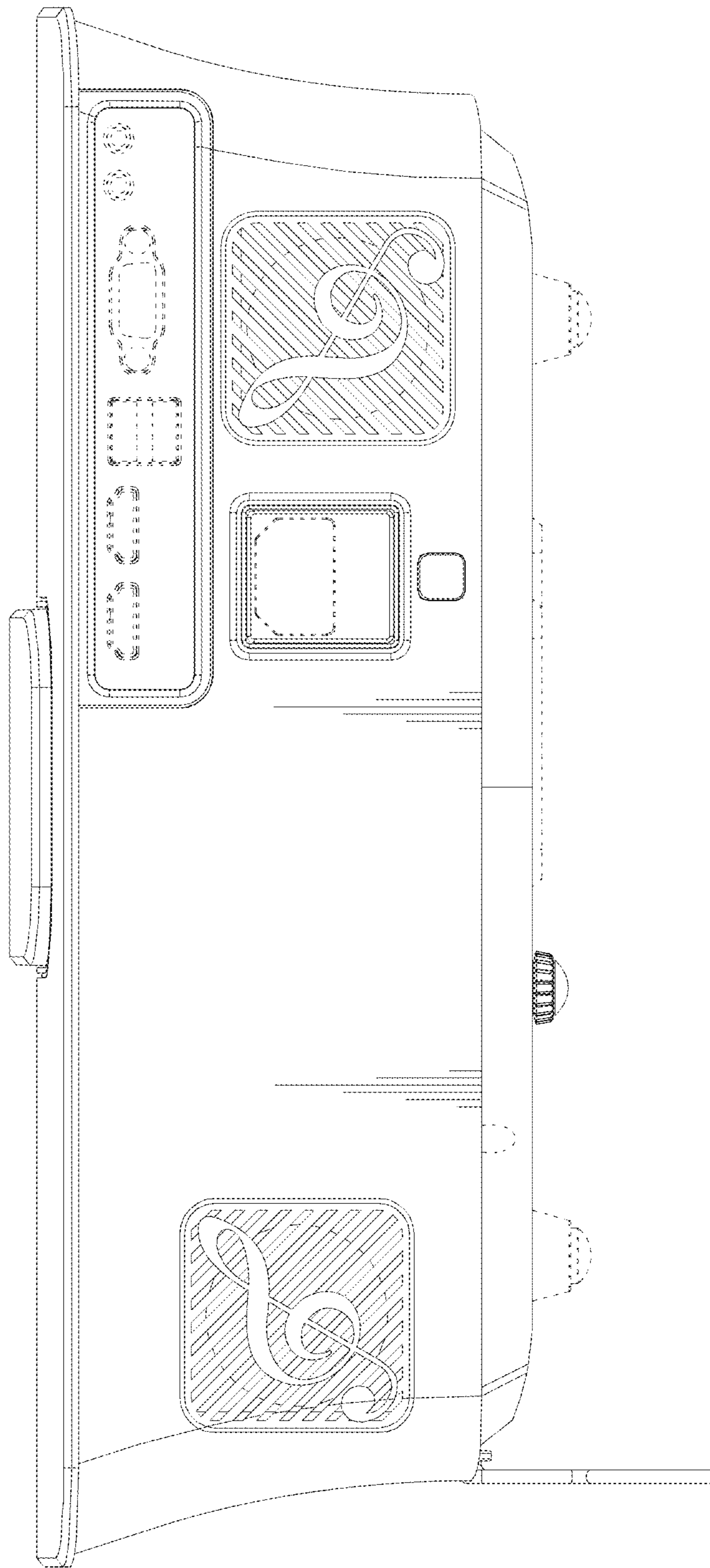

FIG. 4

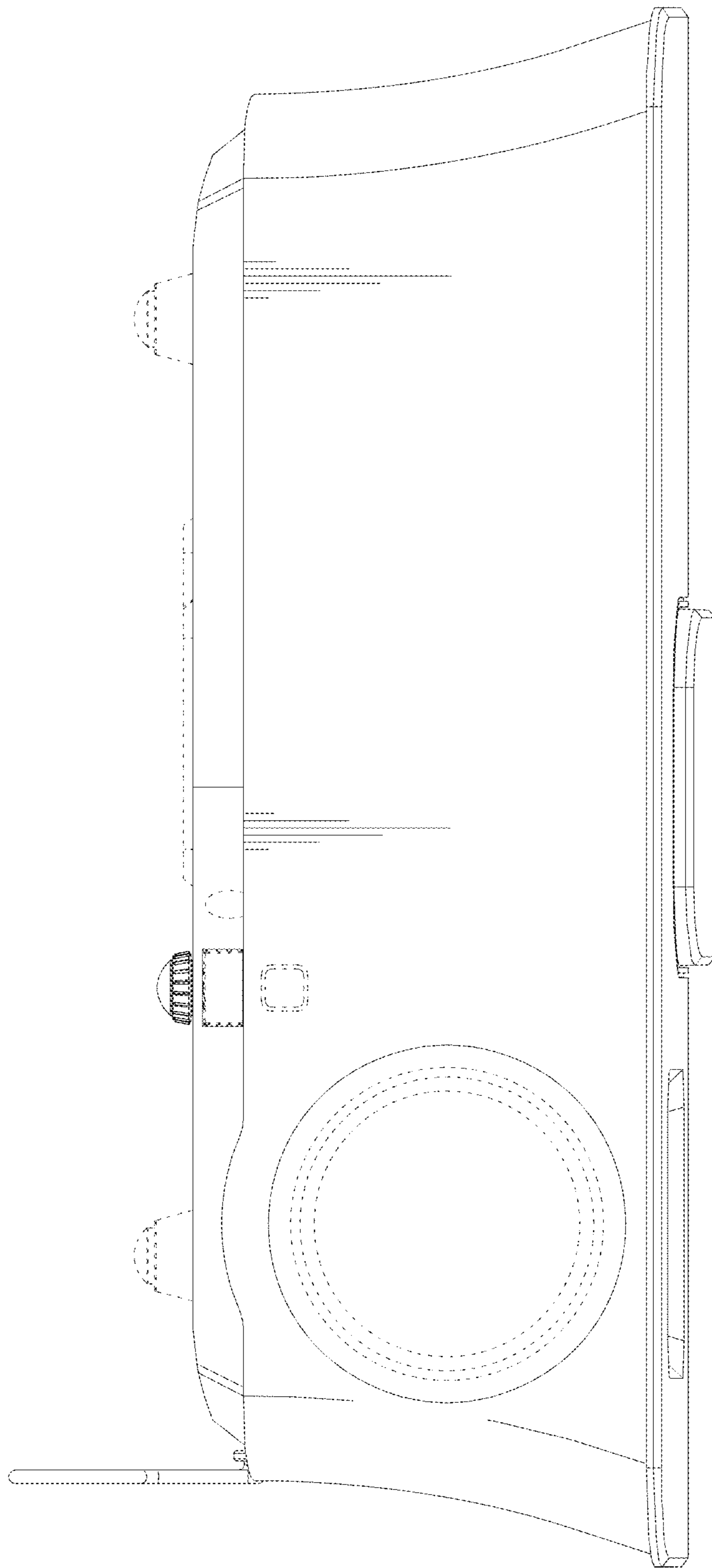

FIG. 5

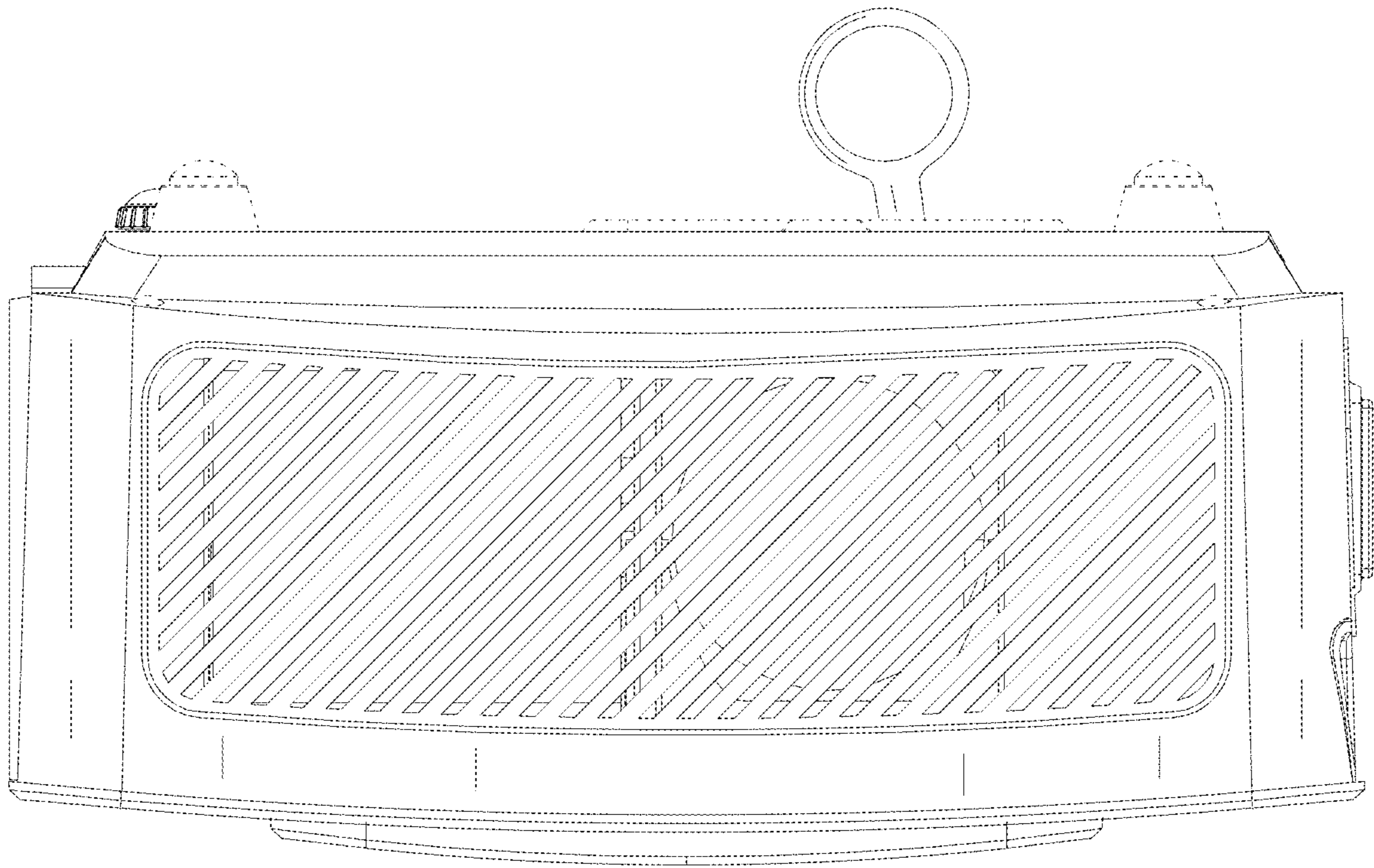

FIG. 6

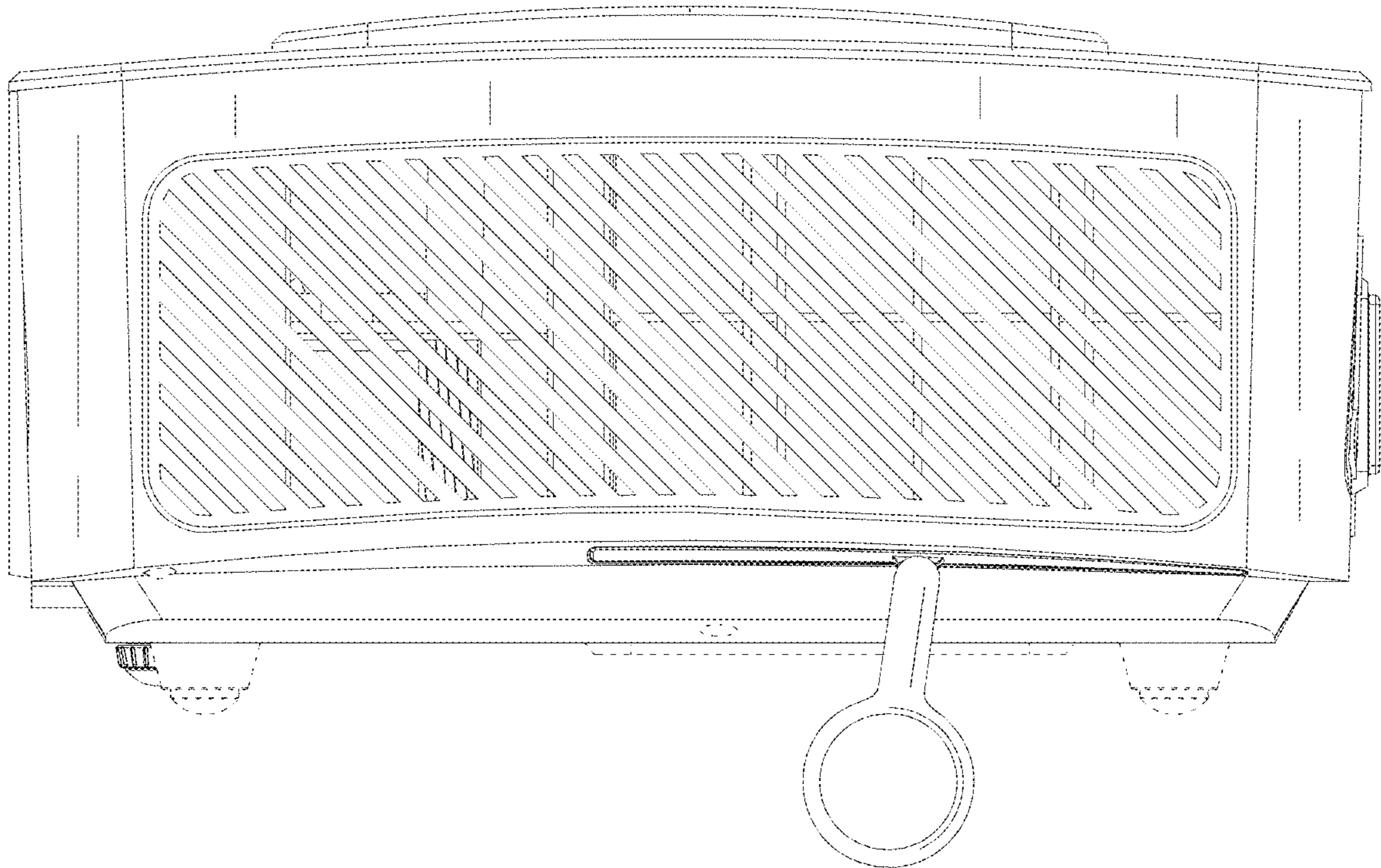

FIG. 7