



US00D978139S

(12) **United States Design Patent** (10) **Patent No.:** **US D978,139 S**
Akana et al. (45) **Date of Patent:** **** Feb. 14, 2023**

(54) **ELECTRONIC DEVICE**

(71) Applicant: **Apple Inc.**, Cupertino, CA (US)

(72) Inventors: **Jody Akana**, San Francisco, CA (US); **Molly Anderson**, San Francisco, CA (US); **Bartley K. Andre**, Palo Alto, CA (US); **Shota Aoyagi**, San Francisco, CA (US); **Anthony Michael Ashcroft**, San Francisco, CA (US); **Marine C. Bataille**, San Francisco, CA (US); **Jeremy Bataillou**, San Francisco, CA (US); **Markus Diebel**, San Francisco, CA (US); **M. Evans Hankey**, San Francisco, CA (US); **Julian Hoenig**, San Francisco, CA (US); **Richard P. Howarth**, San Francisco, CA (US); **Jonathan P. Ive**, San Francisco, CA (US); **Julian Jaede**, San Francisco, CA (US); **Duncan Robert Kerr**, San Francisco, CA (US); **Peter Russell-Clarke**, San Francisco, CA (US); **Benjamin Andrew Shaffer**, San Jose, CA (US); **Mikael Silvano**, San Francisco, CA (US); **Sung-Ho Tan**, San Francisco, CA (US); **Clement Tissandier**, San Francisco, CA (US); **Eugene Antony Whang**, San Francisco, CA (US); **Rico Zörkendörfer**, San Francisco, CA (US)

(73) Assignee: **Apple Inc.**, Cupertino, CA (US)

(**) Term: **15 Years**

(21) Appl. No.: **29/725,386**

(22) Filed: **Feb. 25, 2020**

Related U.S. Application Data

(63) Continuation of application No. 29/683,768, filed on Mar. 15, 2019.

(51) **LOC (14) Cl.** **14-02**

(52) **U.S. Cl.**

USPC **D14/341**

(58) **Field of Classification Search**

USPC ... D14/125-129, 138 AA, 138 AB, 138 AC, D14/138 AD, 138 C, 138 G, 155-159, D14/160-173, 187-188, 189-198, D14/203.1-203.8, 204-216, 217-222, D14/239, 248, 257-258, 315-318, D14/341-347, 371, 374, 432, 439-441, D14/496, 498-506; D6/308, 310; D10/50, 65, 104.1; D18/6-7; D21/324, D21/329-330, 332

CPC ... H04M 1/0202; H04M 1/0266; H04M 1/725
See application file for complete search history.

(56) **References Cited**

U.S. PATENT DOCUMENTS

D337,569 S	7/1993	Kando
D420,354 S	2/2000	Morales
D504,889 S	5/2005	Andre et al.
D548,732 S	8/2007	Cebe et al.
D558,756 S	1/2008	Andre et al.
D558,757 S	1/2008	Andre et al.
D558,758 S	1/2008	Andre et al.
D573,143 S	7/2008	Park et al.
D580,387 S	11/2008	Andre et al.
D597,067 S	7/2009	Oh et al.
D599,342 S	9/2009	Andre et al.
D600,241 S	9/2009	Andre et al.
D602,014 S	10/2009	Andre et al.
D602,015 S	10/2009	Andre et al.
D602,017 S	10/2009	Andre et al.
D602,488 S	10/2009	Jiang et al.
D603,834 S	11/2009	Lyman et al.
D604,297 S	11/2009	Andre et al.
D608,750 S	1/2010	He et al.
D613,736 S	4/2010	Andre et al.
7,697,281 B2	4/2010	Dabov et al.
D618,204 S	6/2010	Andre et al.
D619,555 S	7/2010	Yang et al.
D622,270 S	8/2010	Andre et al.
D622,718 S	8/2010	Andre et al.
D622,719 S	8/2010	Andre et al.
D625,307 S	10/2010	Cheng
D626,937 S	11/2010	Yeo et al.
D627,344 S	11/2010	Chien et al.
D627,769 S	11/2010	Kumagai
D627,778 S	11/2010	Akana et al.

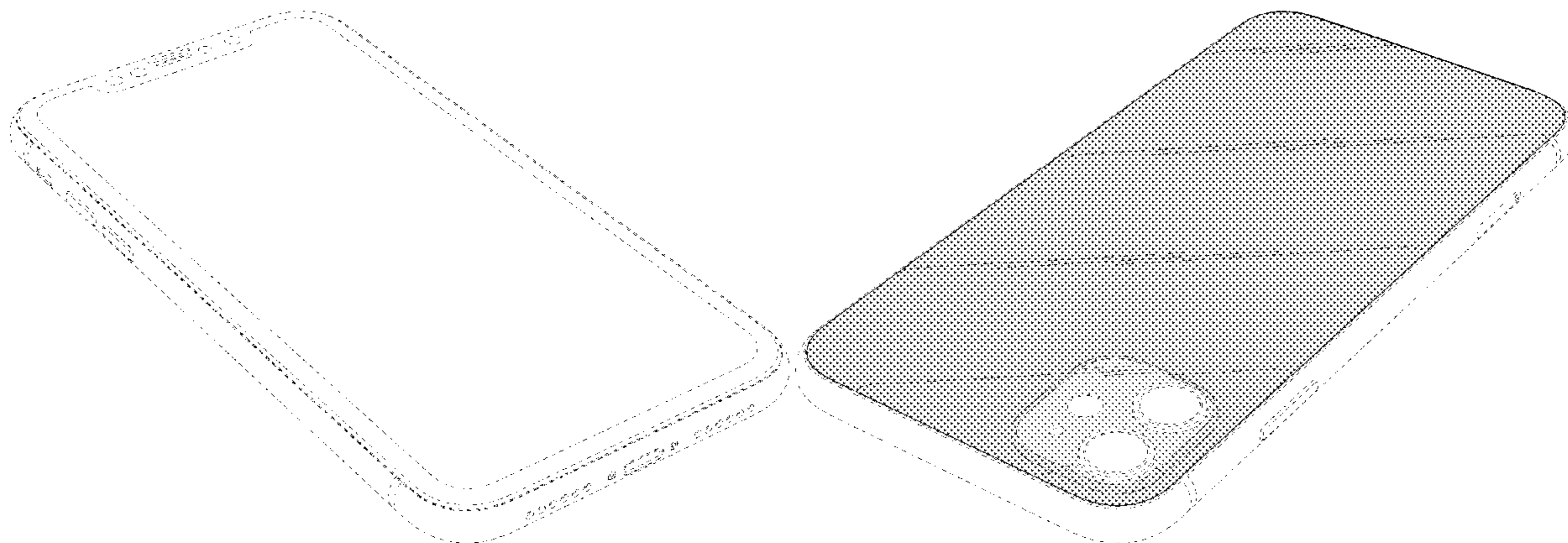

US D978,139 S

D631,028 S	1/2011	Park et al.	D732,497 S	6/2015	Lee et al.
D631,458 S	1/2011	Liao et al.	D732,498 S	6/2015	Huang et al.
D633,461 S	3/2011	Kim et al.	D732,539 S	6/2015	Akana et al.
D633,493 S	3/2011	Akana	D733,146 S	6/2015	Akana et al.
D633,908 S	3/2011	Akana et al.	D736,205 S	8/2015	Park et al.
D635,113 S	3/2011	Park et al.	D739,391 S	9/2015	Chen et al.
D635,952 S	4/2011	Park et al.	D741,279 S	10/2015	Tai et al.
D636,390 S	4/2011	Andre et al.	D742,351 S	11/2015	Chen et al.
D636,392 S	4/2011	Akana et al.	D743,391 S	11/2015	Akana et al.
D636,752 S	4/2011	Liao et al.	D744,993 S	12/2015	Diebel
D638,003 S	5/2011	Chen	D746,275 S	12/2015	Mohammad
D638,815 S	5/2011	Lee et al.	D747,287 S	1/2016	Chang et al.
D639,261 S	6/2011	Garnham et al.	D749,563 S	2/2016	Akana et al.
D639,763 S	6/2011	Kim et al.	9,256,252 B2	2/2016	Chao
D639,771 S	6/2011	Chen	D750,620 S	3/2016	Zhai
D640,663 S	6/2011	Arnholt et al.	D750,729 S	3/2016	Sheikh et al.
D642,563 S	8/2011	Akana et al.	D751,051 S	3/2016	Cho et al.
D648,303 S	11/2011	Park et al.	D752,010 S	3/2016	Kim
D649,968 S	12/2011	Li	D752,037 S	3/2016	Akana et al.
D653,645 S	2/2012	Park	9,274,142 B2	3/2016	Nickel et al.
D654,887 S	2/2012	McManigal et al.	D754,125 S	4/2016	Akana et al.
D656,477 S	3/2012	Yi et al.	D759,008 S	6/2016	Akana et al.
D662,503 S	6/2012	Akana et al.	D760,217 S	6/2016	Akana et al.
D668,627 S	10/2012	Chung	D761,226 S	7/2016	Poulin
D671,905 S	12/2012	Mauritzson	D762,207 S	7/2016	Akana et al.
D671,937 S	12/2012	Akana et al.	D762,610 S	8/2016	Joung et al.
D672,343 S	12/2012	Akana	D767,522 S	9/2016	Wu et al.
D673,562 S	1/2013	Johnson	D769,208 S	10/2016	Ho et al.
D676,432 S	2/2013	Hasbrook et al.	9,462,094 B2	10/2016	Liu et al.
D677,641 S	3/2013	Sutherland et al.	D770,411 S	11/2016	Zhang
D677,642 S	3/2013	Park	D770,433 S	11/2016	Kangasmaa et al.
D677,657 S	3/2013	Akana et al.	D771,607 S	11/2016	Kim et al.
D680,092 S	4/2013	Tsai et al.	D771,622 S	11/2016	Akana et al.
D680,984 S	4/2013	Harmon et al.	D771,623 S	11/2016	Akana et al.
D680,995 S	4/2013	Lee	D772,865 S	11/2016	Akana et al.
D681,032 S	4/2013	Akana et al.	D774,499 S	12/2016	Fathollahi
D681,632 S	5/2013	Akana et al.	D777,700 S	1/2017	Kwon et al.
D683,711 S	6/2013	Hofer et al.	9,537,219 B2	1/2017	Ayala et al.
D684,571 S	6/2013	Akana et al.	D778,867 S	2/2017	Husgafvel et al.
D686,586 S	7/2013	Cho et al.	D779,484 S	2/2017	Akana et al.
D687,404 S	8/2013	Yoshimura	9,577,318 B2	2/2017	Pascolini et al.
D687,793 S	8/2013	Park	D780,748 S	3/2017	Wang et al.
D688,218 S	8/2013	Lee	D781,807 S	3/2017	Hubbard et al.
D688,221 S	8/2013	Zuffo et al.	9,594,147 B2	3/2017	Han et al.
D688,660 S	8/2013	Akana et al.	D783,565 S	4/2017	Kim et al.
D689,455 S	9/2013	Daniel	D783,566 S	4/2017	Kim et al.
8,526,180 B2	9/2013	Rayner	D783,602 S	4/2017	Akana et al.
D690,693 S	10/2013	Akana et al.	D784,314 S	4/2017	Ryu et al.
D691,133 S	10/2013	Akana et al.	D784,315 S	4/2017	Ryu et al.
D692,881 S	11/2013	Akana et al.	D786,229 S	5/2017	Kim et al.
D693,324 S	11/2013	Wang	D790,535 S	6/2017	Akana et al.
D693,785 S	11/2013	Sutherland et al.	D792,366 S	7/2017	Zhang et al.
D696,247 S	12/2013	Kim	D792,386 S	7/2017	Lee et al.
D697,911 S	1/2014	McManigal et al.	D794,623 S	8/2017	Kwon et al.
D698,770 S	2/2014	Park	D796,497 S	9/2017	Kim et al.
D698,773 S	2/2014	Wildner	9,761,927 B2	9/2017	Kasar et al.
8,640,868 B2	2/2014	O'Dowd et al.	D798,851 S	10/2017	Kim et al.
D702,219 S	4/2014	Suk	D798,852 S	10/2017	Kim et al.
D705,188 S	5/2014	Chau et al.	D800,710 S	10/2017	Ryu et al.
D706,235 S	6/2014	Kim	D800,716 S	10/2017	Akana et al.
D706,251 S	6/2014	Park	D801,321 S	10/2017	Kim et al.
D706,301 S	6/2014	Akana et al.	D803,209 S	11/2017	Akana et al.
D706,776 S	6/2014	Akana et al.	D805,495 S	12/2017	Kester et al.
D707,223 S	6/2014	Akana et al.	D806,705 S	1/2018	Akana et al.
D708,608 S	7/2014	Sugiyama et al.	D810,715 S	2/2018	Cho et al.
D710,815 S	8/2014	Kim et al.	D835,620 S	12/2018	Akana et al.
8,804,353 B2	8/2014	Montevirgen et al.	D883,946 S *	5/2020	Xu D14/138 G
D712,384 S	9/2014	Hibi	D896,232 S *	9/2020	Akana D14/439
D712,405 S	9/2014	Akana et al.	D905,696 S *	12/2020	Akana D14/439
D713,833 S	9/2014	Wilkey	D919,589 S *	5/2021	Ji D14/138 G
D718,268 S	11/2014	Wu et al.	D920,942 S *	6/2021	Zhu D14/138 G
8,879,245 B2	11/2014	Kim	D924,828 S *	7/2021	Oh D14/138 G
D719,941 S	12/2014	Kim et al.	D940,119 S *	1/2022	Kim D14/248
D720,747 S	1/2015	Kim et al.	D942,437 S *	2/2022	Wang D14/248
D721,344 S	1/2015	Lee et al.	D945,978 S *	3/2022	Akana D14/138 G
8,933,347 B2	1/2015	Kiple et al.	D946,547 S *	3/2022	Kim D14/138 G
D724,572 S	3/2015	Wildner	D946,548 S *	3/2022	Kim D14/138 G
8,989,826 B1	3/2015	Connolly	D947,849 S *	4/2022	Akana D14/439
D731,481 S	6/2015	Akana et al.	D947,850 S *	4/2022	Akana D14/439

D951,897 S *	5/2022	Ha	D14/138 G	RU	90363 U1	10/2014
D954,670 S *	6/2022	Lee	D14/138 G	RU	104650 U1	8/2017
D954,671 S *	6/2022	Lee	D14/138 G	TW	D149042 S	9/2012
D955,354 S *	6/2022	Cho	D14/138 G	TW	D169484 S	8/2015
D958,768 S *	7/2022	Lee	D14/138 G	TW	D172231 S	12/2015
D958,770 S *	7/2022	Oh	D14/138 G	WO	WO-DM080555 S	2/2013
2009/0247244 A1	10/2009	Mittleman et al.				
2011/0050560 A1	3/2011	Foster et al.				
2011/0117971 A1	5/2011	Kim et al.				
2011/0268218 A1	11/2011	Kang et al.				
2012/0088555 A1	4/2012	Hu				
2012/0168577 A1	7/2012	Cheng				
2012/0170189 A1	7/2012	Li et al.				
2012/0329535 A1	12/2012	Kuo				
2013/0321237 A1	12/2013	Woodhull et al.				
2013/0331156 A1	12/2013	Lui				
2016/0191095 A1	6/2016	Santelli				

OTHER PUBLICATIONS

iPhone 11, Sep. 20, 2019, [retrieved Sep. 24, 2022], Retrieved from Internet, URL: <<https://www.cnn.com/cnn-underscored/reviews/apple-iphone-11-pricing-features>> (Year: 2019).*

Review: Apple iPhone 11, Sep. 17, 2019, [retrieved Sep. 24, 2022], Retrieved from Internet, URL: <<https://www.wired.com/review/apple-iphone-11/>> (Year: 2019).*

iPhone 11 Teardown, Oct. 14, 2019, [retrieved Sep. 24, 2022], Retrieved from Internet, URL: <<https://www.ifixit.com/Teardown/iPhone+11+Teardown/126192>> (Year: 2019).*

iPhone 11, iPhone 11 Pro, and iPhone 11 Pro Max, Aug. 30, 2019, [retrieved Sep. 24, 2022], Retrieved from Internet, URL: <https://www.gsmarena.com/iphone_11_iphone_11_pro_and_iphone_11_pro_max_have_all_their_specs_seemingly_leaked-news-38965.php>(Year: 2019).*

Apple iPhone 5 pictures, as posted at GsmArena.com [online], [retrieved on Apr. 27, 2017]. Available on the Internet, (URL: http://www.gsmarena.com/apple_iphone_5-pictures-4910.php#image15), accessed on Sep. 2012.

Apple iPhone 7 is here with a water resistant body, better cameras, 256GB capacity & no headphone jack, posted Sep. 8, 2016, [retrieved Aug. 28, 2017]. Retrieved from Internet, (URL: <https://collinsdail.blogspot.com/2016/09/apple-iphone-7-is-here-with-water.html>).

Apple iPhone 7 and 7plus | New Camera, posted Sep. 8, 2016, [retrieved Aug. 28, 2017]. Retrieved from Internet, (URL: <http://sujoyrdas.blogspot.com/2016/09/apple-iphone-7-and-7plus-new-camera.html>).

Brownlee, Marques, “Apple iPhone X Unboxing!” Youtube.com, Oct. 31, 2017, Available at (<https://youtu.be/ODoQYGZt8M?t=68>).

Carlson, Ronald, Tapscape.com , “Translucent iPhone: Will Apple Revisit G3 iMac?,” accessed at <http://www.tapscape.com/translucent-iphone/>, accessed on Apr. 3, 2013, 3 pages.

ConceptsiPhone, “iPhone 8 and iPhone 8 Plus—Introducing” Youtube, Oct. 7, 2016, accessed at (<https://www.youtube.com/watch?v=WSf8aJIYCjg>).

Cultofandroid, “This Android-Powered iPhone 5C Clone Will Cost Just \$100 In China” accessed at http://www.cultofandroid.com/40408/this-android-powered-iphone-5c-clone-will-cost-just-100-in-china/?utm_campaign=twitter&utm_medium=twitter&utm_source=twitter, accessed on Aug. 27, 2013, 2 pages.

Daily Life News, “iPhone 5s Leaked Images Hint 2 Different Screen Sizes.” accessed at <https://www.youtube.com/watch?v=8tcTHa63WHI>, accessed on Apr. 10, 2013, 4 pages.

Engadget, “Meizu’s M8? Apple lawyers, start your engines”, accessed at <http://www.engadget.com/2007/01/29/meizus-m8-apple-lawyers-start-your-engines/>, accessed on Jan. 29, 2007, 3 pages.

Everythingapplepro, “The 2018 iPhone X Plus Will be BIG!” Youtube.com, [retrieved on Feb. 12, 2018], Retrieved from the Internet: (<https://youtu.be/m2iMjpAkTeQ?t=14>).

Faulkner, Cameron, “Essential Phone Review”, Tech Radar, [retrieved on Nov. 25, 2017], 2017, accessed at Retrieved from the Internet: (URL: <http://www.techradar.com/reviews/essential-phone>).

Gokey, M., “LG G3 vs. HTC One M8: Which Android Flag Should iPhone Haters Fly?”, published Sep. 18, 2014, accessed at www.digitaltrends.com/mobile/lg-g3-vs-htc-one-m8/, 12 pages.

Gorsler, Fabian, “Leak Suggests Apple Will Release 3 New iPhone Models in 2018” Highsnobiety.com, [retrieved on Nov. 14, 2017], Retrieved from the Internet: (<https://www.highsnobiety.com/2017/11/14/three-new-iphones-2018/>).

Gsmarena, “Nokia Lumia 820 ”, accessed at http://www.gsmarena.com/nokia_lumia_820-4968.php , accessed on Aug. 29, 2013, 2 pages.

Gsmarena, “Xiaomi MI-2 ”, accessed at http://www.gsmarena.com/xiaomi_mi_2-4928.php , accessed on Aug. 29, 2013, 2 pages.

FOREIGN PATENT DOCUMENTS

CN	300928488 S	5/2009
CN	301134880 S	2/2010
CN	301139661 S	2/2010
CN	301161836 S	3/2010
CN	301271887 S	6/2010
CN	301300814 S	8/2010
CN	301794564 S	1/2012
CN	301867415 S	3/2012
CN	302242618 S	12/2012
CN	302268386 S	1/2013
CN	302279529 S	1/2013
CN	302321988 S	2/2013
CN	302333118 S	2/2013
CN	302350915 S	3/2013
CN	302404040 S	4/2013
CN	302430473 S	5/2013
CN	202998218 U	6/2013
CN	302455942 S	6/2013
CN	302476338 S	6/2013
CN	302560014 S	9/2013
CN	302588771 S	9/2013
CN	302606411 S	10/2013
CN	302619300 S	10/2013
CN	302748579 S	2/2014
CN	302808732 S	4/2014
CN	302873818 S	7/2014
CN	302982246 S	10/2014
CN	303000183 S	11/2014
CN	303000194 S	11/2014
CN	303453788 S	11/2015
CN	303617715 S	3/2016
CN	303647864 S	4/2016
CN	303774339 S	8/2016
CN	303805687 S	8/2016
CN	304095914 S	4/2017
CN	304095915 S	4/2017
CN	304130421 S	5/2017
DM	095015	2/2017
EM	002088591-0001	8/2012
GB	6085050	* 3/2020
HK	1914134-0001	* 12/2019
HK	1914135-0005	* 1/2020
IN	210894-0001	6/2007
IN	210897-0001	6/2007
IN	2768570001	2/2016
JP	D1326330 S	4/2008
JP	D1351277 S	2/2009
JP	D1456810 S	12/2012
JP	D1469635 S	5/2013
JP	D1478342 S	9/2013
JP	1548987 S	5/2016
JP	1563161 S	11/2016
JP	1574816 S	4/2017
JP	D1600999 S	4/2018
KR	3006068280	7/2011
KR	300849814	4/2016
KR	300902453	9/2017
RU	85816	7/2013
RU	89999 U1	9/2014

Gsmarena, “Xiaomi MI-2s”, accessed at http://www.gsmarena.com/xiaomi_mi_2s-5397.php, accessed on Aug. 29, 2013, 2 pages.

Hands-On With an iPhone 8 Dummy Model, posted Aug. 10, 2017, [retrieved Aug. 28, 2017]. Retrieved from Internet, (URL: <https://www.youtube.com/watch?v=YuQUBhOAbUM>).

Identify your iPhone Model, Retrieved from the Internet URL: <https://support.apple.com/en-us/HT201296>.

“iPhone 6, Une Enieme Maquette Comparee Avec L’iPhone 5s,” published May 3, 2014, accessed at <http://www.nowhereelse.fr/iphone-6-maquette-comparee-iphone-5s-97315/>, 2 pages.

K11 Bumper vs. RhinoShield Crash Guard: Super Thin Protective Bumpers for iPhone 6s Plus!, posted Feb. 23, 2016, [retrieved Jan. 26, 2018]. Retrieved from Internet, <url:<https://www.youtube.com/watch?v=eX5ETZkOhj4>>, 3 pages.</url:<a>

Karmakar, Amit, “The iPhone X plus 2018 Dummy model and leaks” Youtube.com, [retrieved on Dec. 1, 2017], Retrieved from the Internet: (<https://www.youtube.com/watch?v=1pEesxpiOd4>).

MacManus, Christopher, cnet.com, “Artist pictures a budget iPhone—in color.” accessed at <http://www.cnet.com/au/news/artist-pictures-a-budget-iphone-in-color/>, accessed at Mar. 21, 2013, 4 pages.

Maggio, Edoardo, “These renders show what Apple might have planned for the successor to the iPhone X” BusinessInsider.com, [retrieved on Jan. 24, 2018], Retrieved from the Internet: (<https://www.businessinsider.com.au/martin-hajek-renders-apple-2018-iphone-x-successor-2018-1?r=US&IR=T>).

Mayo, B., “Purported iPhone 6 Pictures Show Protruding Camera, Rounded Edges,” 9to5Mac.com, accessed at <http://9to5mac.com/2014/03/31/purported-iphone-6-pictures-show-protruding-camera-rounded-edges/>, 23 pages.

Mia P., “Apple Leak Reveals All Glass Phone With 3D Sensor; Touch Bar Feature Redefines Emoji Use; Is This iPhone 8?” GameNGuide, Oct. 31, 2016, accessed at (<http://www.gamenguide.com/articles/60727/20161031/apple-leak-reveals-all-glass-phone-with-3d-sensor-touch-bar-feature-redefines-emoji-use-is-this-iphone-8.htm>).

Nokia, “Nokia Lumia 820—Our most versatile Lumia”, accessed at <http://www.nokia.com/global/products/phone/lumia820/>, accessed on Aug. 29, 2013, 6 pages.

@NowhereElseFr, “Just Another Purported #iPhone6 or #iPhoneAir Dummy . . . #Apple,” published May 4, 2014, accessed at <https://twitter.com/NowhereElseFr/status/462938116924264448/photo/1>, 5 pages.

@Onleaks, “#iPhone X!!! Yes, time has already come to meet the new #iPhone . . .” dated Jan. 6, 2019, accessed at <https://twitter.com/Onleaks/status/1081902300434780161>, 5 pages.

Photo-John, “Apple’s iPhone 5 Camera—What’s New?”, as archived at <https://web.archive.org/web/20140805181048/http://www.photographyreview.com/reviews/apple-iphone-5-camera-whats-new>, published Sep. 12, 2012, 3 pages.

Schroeder, S., “Sharp Aquos S2 is a Nearly Bezel-Less Phone with Mid-Range Specs,” Mashable, Aug. 8, 2017, Retrieved from the Internet: (URL: <http://mashable.com/2017/08/08/sharp-aquos-s2/#C05q3N0tzOqV>), 10 Pages.

“Sharp Executive Confirms iPhone 8 to Use OLED Display; Limited to Only Premium 5.5-inch Plus Model” Oct. 29, 2016, accessed at (<http://www.redsn0w.us/2016/10/sharp-executive-confirms-iphone-8-to.html>).

Stuff Staff in News, stuffmideast.com “Apple’s new iPhone to come in a five colours.” accessed at <http://stuffmideast.com/2013/04/11/151344/apples-new-iphone-to-come-in-a-five-colours/>, accessed on Apr. 11, 2013, 1 page.

stuff.tv, “Sparse wallets rejoice, the plastic budget iPhone 5S cometh, The iPhone 5S may not be an incremental increase but a decrease, in price and build quality.” accessed at <http://www.stuff>

tv/news/sparse-wallets-rejoice-plastic-budget-iphone-5s-cometh, accessed on Mar. 23, 2013, 1 page.

Swift, “BBK Vivo Xplay X510W Review,” published Oct. 21, 2013, accessed at <http://chinesetech.net/2013/10/21/bbk-vivo-xplay-x510w-review/>, 12 pages.

Team Digit, “Exclusive: First look at 2019 Apple iPhone XI renders,” [retrieved on Jan. 6, 2019]. Retrieved from the Internet: (<https://www.digit.in/news/mobile-phones/exclusive-first-look-at-2019-iphone-xi-renders-45655.html>), 3 pages.

TechDesigns, “iPhone 8 Official 2017—Concept” Youtube, Oct. 27, 2016, accessed at (<https://www.youtube.com/watch?v=LYUJYLD1XR0>).

Verykool Spark LTE SL5011 review: All that glitters is not gold, posted May 24, 2016, [retrieved on Sep. 30, 2018]. Retrieved from Internet, (URL:<https://www.androidguys.com/reviews/verykool-spark-lte-sl5011-review-all-that-glitters-is-not-gold/>).

welectronics.com, “Xiaomi MI 2 GSM unlocked,” accessed at <http://www.welectronics.com/gsm/misc/XIAOMI-MI-2.HTML?gclid=CK7Nr9bv-rYCFY0o4AodZ0EAEW>, accessed at Aug. 29, 2013, 2 pages.

Wu, Debbie, “All three iPhone 8 models to have glass backs” Nikkei Asian Review, Oct. 26, 2016, accessed at (<https://asia.nikkei.com/Business/Companies/All-three-iPhone-8-models-to-have-glass-backs?page=1>).

* cited by examiner

Primary Examiner — Messina L Smith

Assistant Examiner — Aram Kwon

(74) *Attorney, Agent, or Firm* — Sterne, Kessler, Goldstein & Fox P.L.L.C.

(57)

CLAIM

The ornamental design for an electronic device, as shown and described.

DESCRIPTION

FIG. 1 is a bottom front perspective view of an electronic device showing the claimed design;

FIG. 2 is a top rear perspective view thereof;

FIG. 3 is a front view thereof;

FIG. 4 is a rear view thereof;

FIG. 5 is a left side view thereof;

FIG. 6 is a right side view thereof;

FIG. 7 is a top view thereof; and,

FIG. 8 is a bottom view thereof.

The broken lines in the figures show portions of the electronic device that form no part of the claimed design.

FIGS. 1-8 are illustrated to show contrasting appearance. Areas of the electronic device that appear in different shades of gray/black represent areas with contrasting appearances.

1 Claim, 6 Drawing Sheets

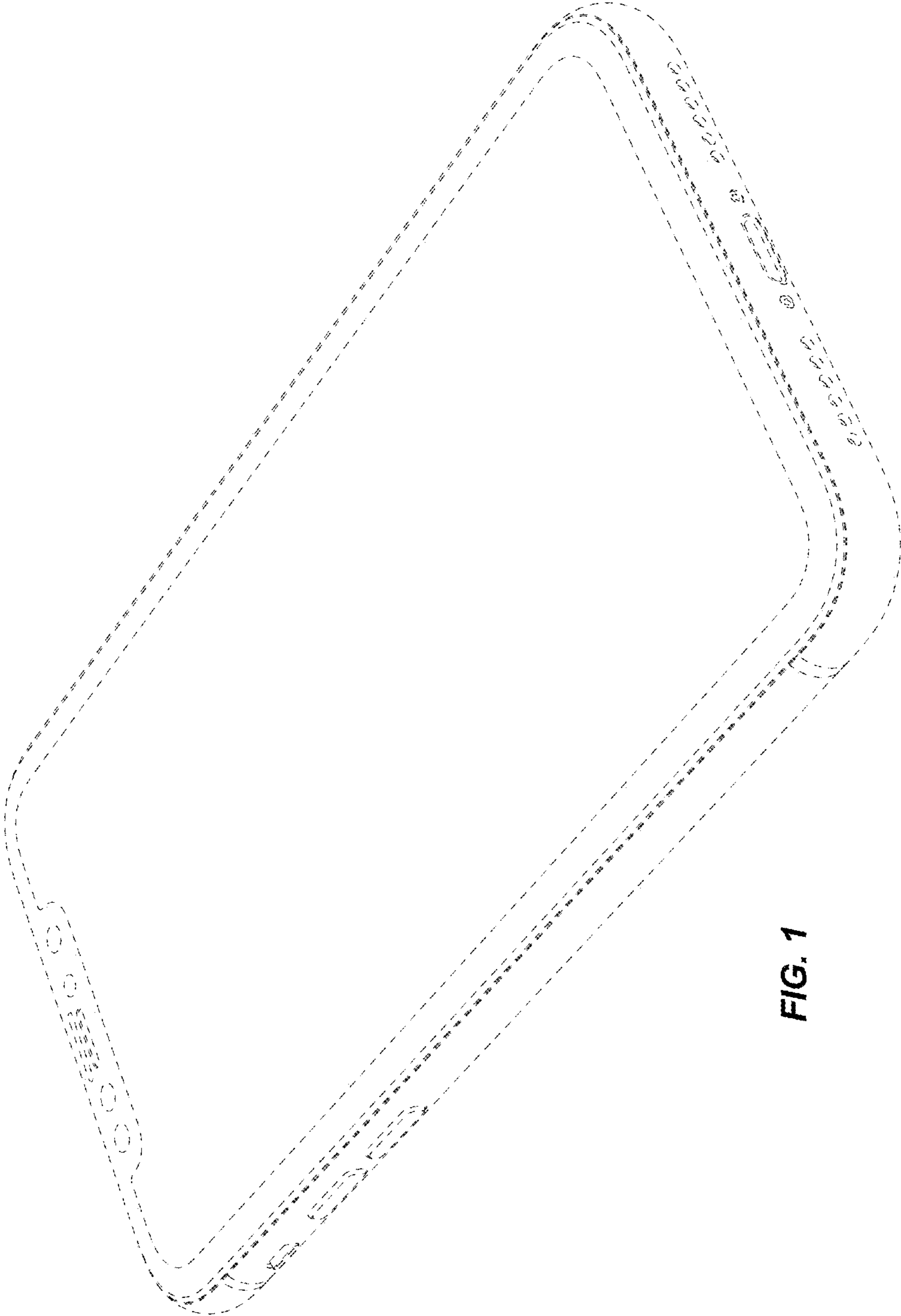

FIG. 1

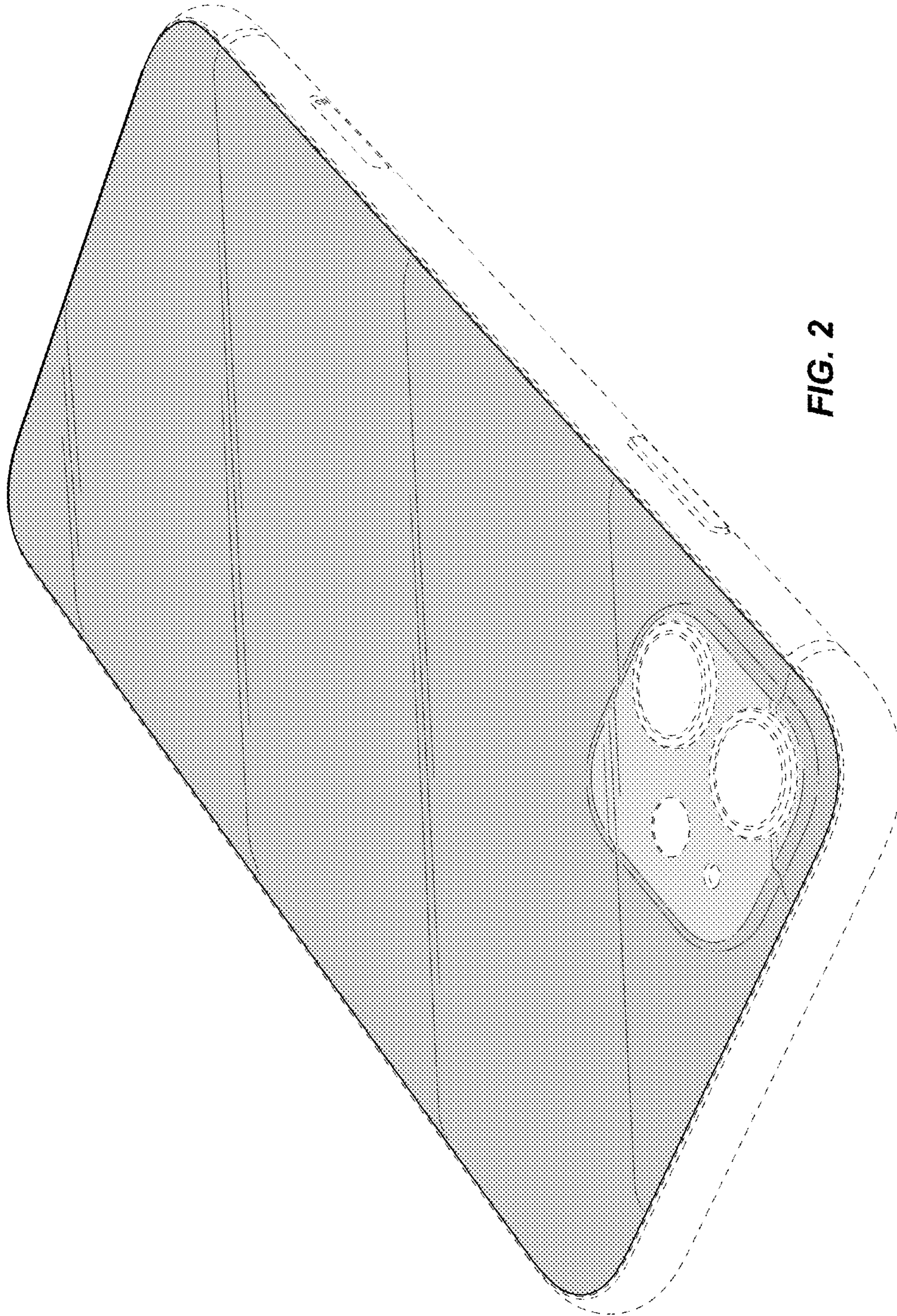

FIG. 2

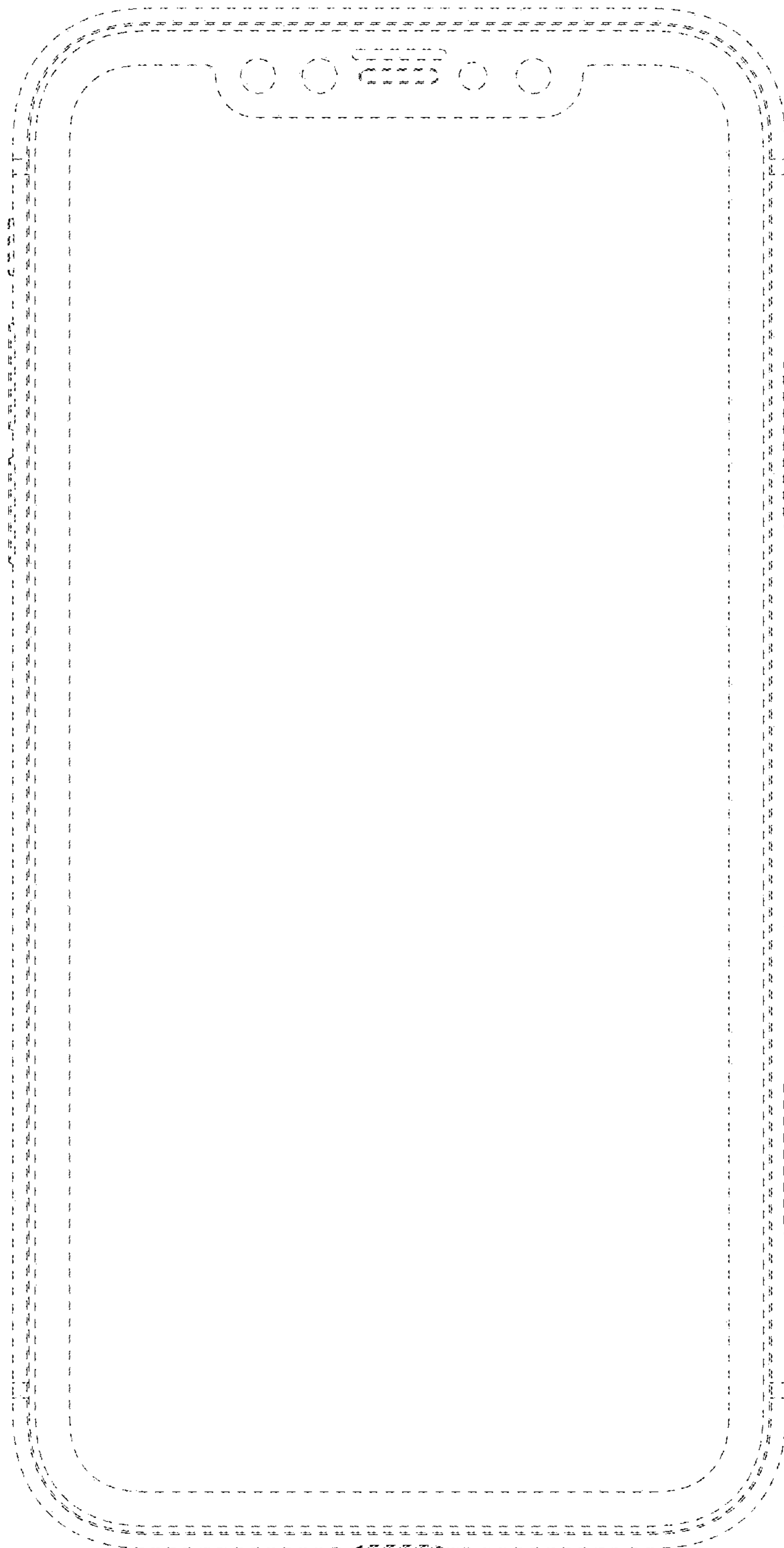

FIG. 3

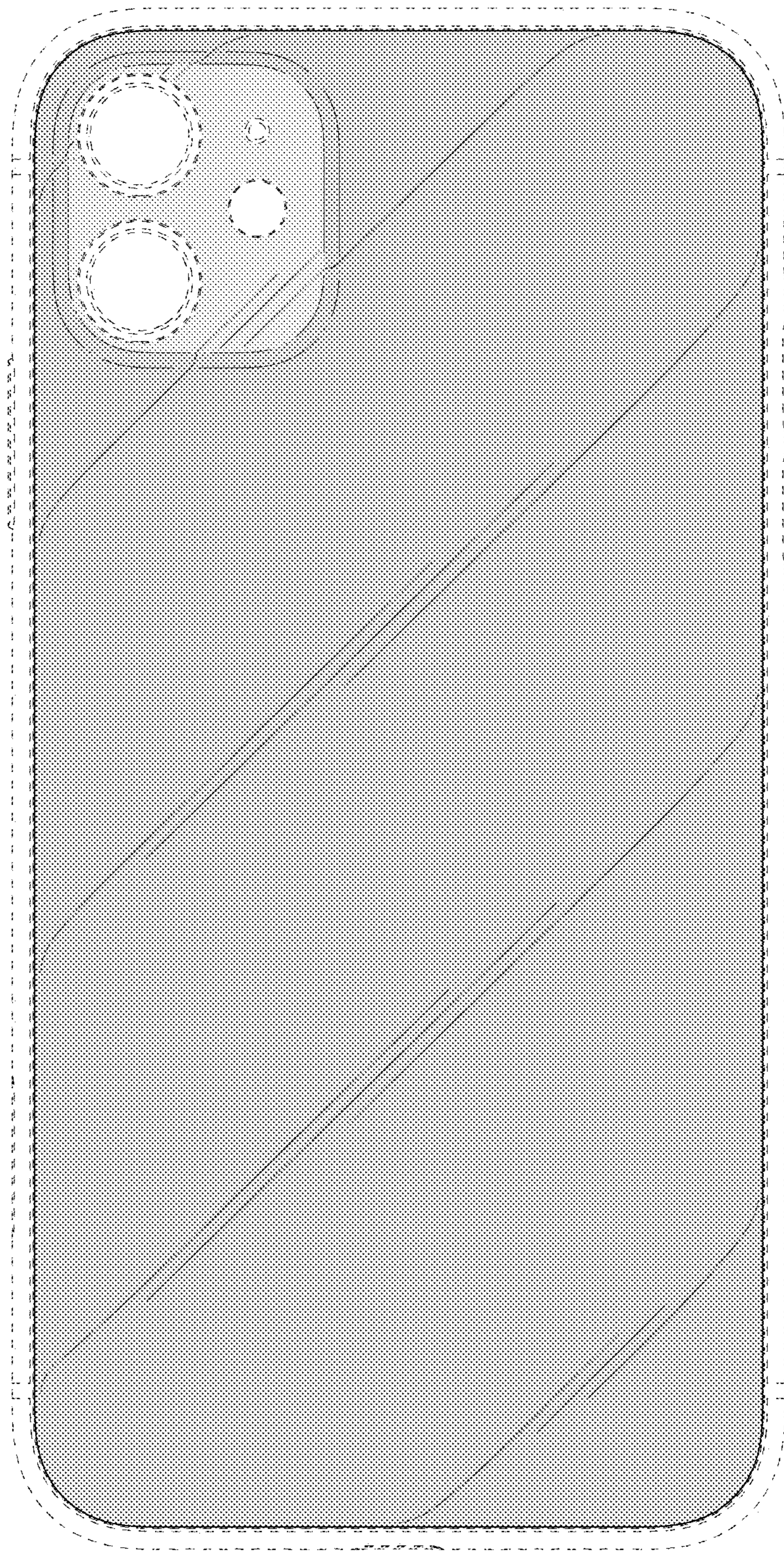

FIG. 4



FIG. 5

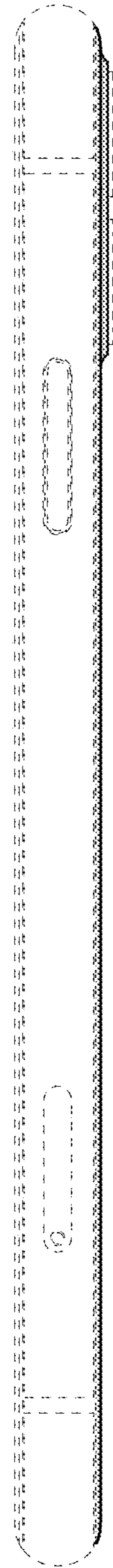

FIG. 6

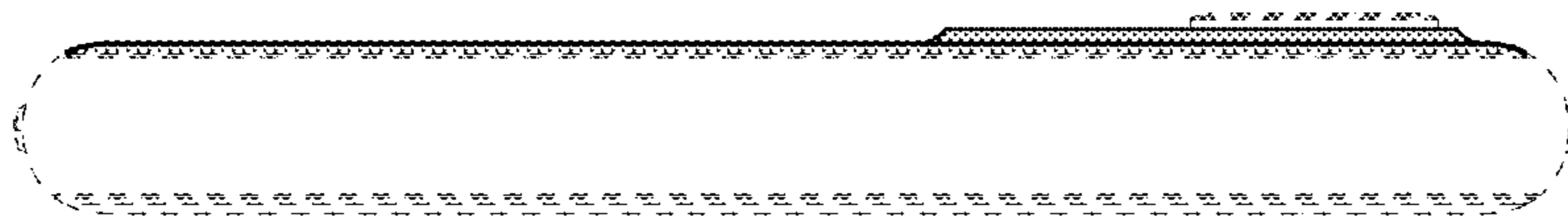

FIG. 7



FIG. 8