



US00D978034S

(12) **United States Design Patent** (10) **Patent No.:** **US D978,034 S**  
**Ozawa et al.** (45) **Date of Patent:** **\*\* Feb. 14, 2023**

(54) **FRONT BUMPER FOR AN AUTOMOBILE**

(71) Applicant: **Subaru Corporation**, Tokyo (JP)

(72) Inventors: **Shuji Ozawa**, Tokyo (JP); **Shinsuke Aizawa**, Tokyo (JP)

(73) Assignee: **Subaru Corporation**, Tokyo (JP)

(\*\*) Term: **15 Years**

(21) Appl. No.: **29/785,075**

(22) Filed: **May 24, 2021**

(51) **LOC (14) Cl.** ..... **12-16**

(52) **U.S. Cl.**  
USPC ..... **D12/169**

(58) **Field of Classification Search**  
USPC ..... D12/169, 196, 86, 90-92, 163, 190, 98,  
D12/164; 293/102, 113, 115, 117, 120,  
293/193.11; 296/180.1, 180.2  
CPC ..... B60R 19/02; B60R 19/04; B62D 25/08  
See application file for complete search history.

(56) **References Cited**

**U.S. PATENT DOCUMENTS**

D733,621 S *	7/2015	Ikuma	.....	D12/169
D748,021 S *	1/2016	Iwanaga	.....	D12/169
D751,957 S *	3/2016	Tomatsu	.....	D12/169
D752,486 S *	3/2016	Sperling	.....	D12/169
D784,214 S *	4/2017	Kanasugi	.....	D12/169
D793,923 S *	8/2017	Katou	.....	D12/169
D800,032 S *	10/2017	Yokoi	.....	D12/169
D800,035 S *	10/2017	Takamatsu	.....	D12/169
D813,735 S *	3/2018	Kanno	.....	D12/169
D813,736 S *	3/2018	Jevremovic	.....	D12/169

D814,989 S *	4/2018	Ino	.....	D12/169
D829,616 S *	10/2018	Fuchino	.....	D12/169
D829,617 S *	10/2018	Takamatsu	.....	D12/169
D829,618 S *	10/2018	Kamahara	.....	D12/169
D830,250 S *	10/2018	Tomita	.....	D12/169
D839,150 S *	1/2019	Roller	.....	D12/169
D851,562 S *	6/2019	Andoh	.....	D12/169
D904,940 S *	12/2020	Utsunomiya	.....	D12/169
D904,944 S *	12/2020	Higurashi	.....	D12/169
D906,907 S *	1/2021	Yagi	.....	D12/169
D909,933 S *	2/2021	Tanaka	.....	D12/169
D921,545 S *	6/2021	Fuchino	.....	D12/169
D937,154 S *	11/2021	Akcaay	.....	D12/169
D939,403 S *	12/2021	Matsumoto	.....	D12/169
D939,404 S *	12/2021	Takeda	.....	D12/169
D939,405 S *	12/2021	Kobayashi	.....	D12/169

\* cited by examiner

*Primary Examiner* — Melody N Brown

(74) *Attorney, Agent, or Firm* — Banner & Witcoff Ltd.

(57) **CLAIM**

We claim the ornamental design for a front bumper for an automobile, as shown and described.

**DESCRIPTION**

FIG. 1 is a front perspective view for a “front bumper for an automobile” showing our new design, FIG. 2 is a rear perspective view thereof, FIG. 3 is a front view thereof, FIG. 4 is a rear view thereof, FIG. 5 is a top view thereof, FIG. 6 is a bottom view thereof, FIG. 7 is a left-side view thereof; and, FIG. 8 is a right-side view thereof.

**1 Claim, 4 Drawing Sheets**

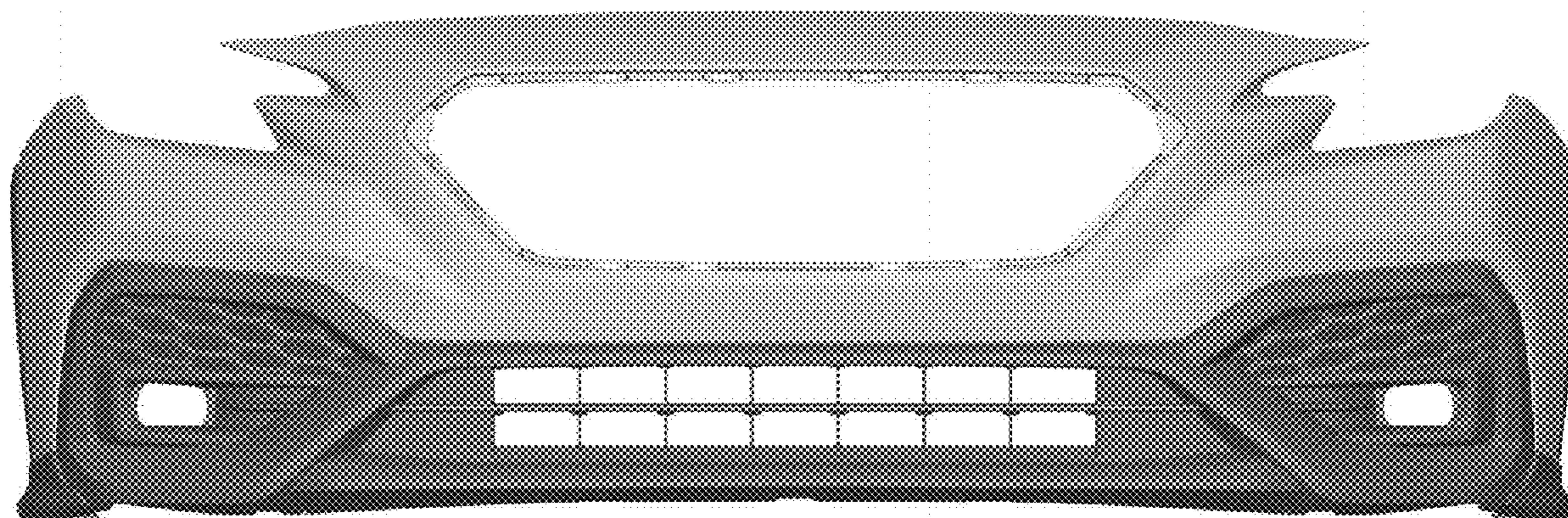

FIG. 1

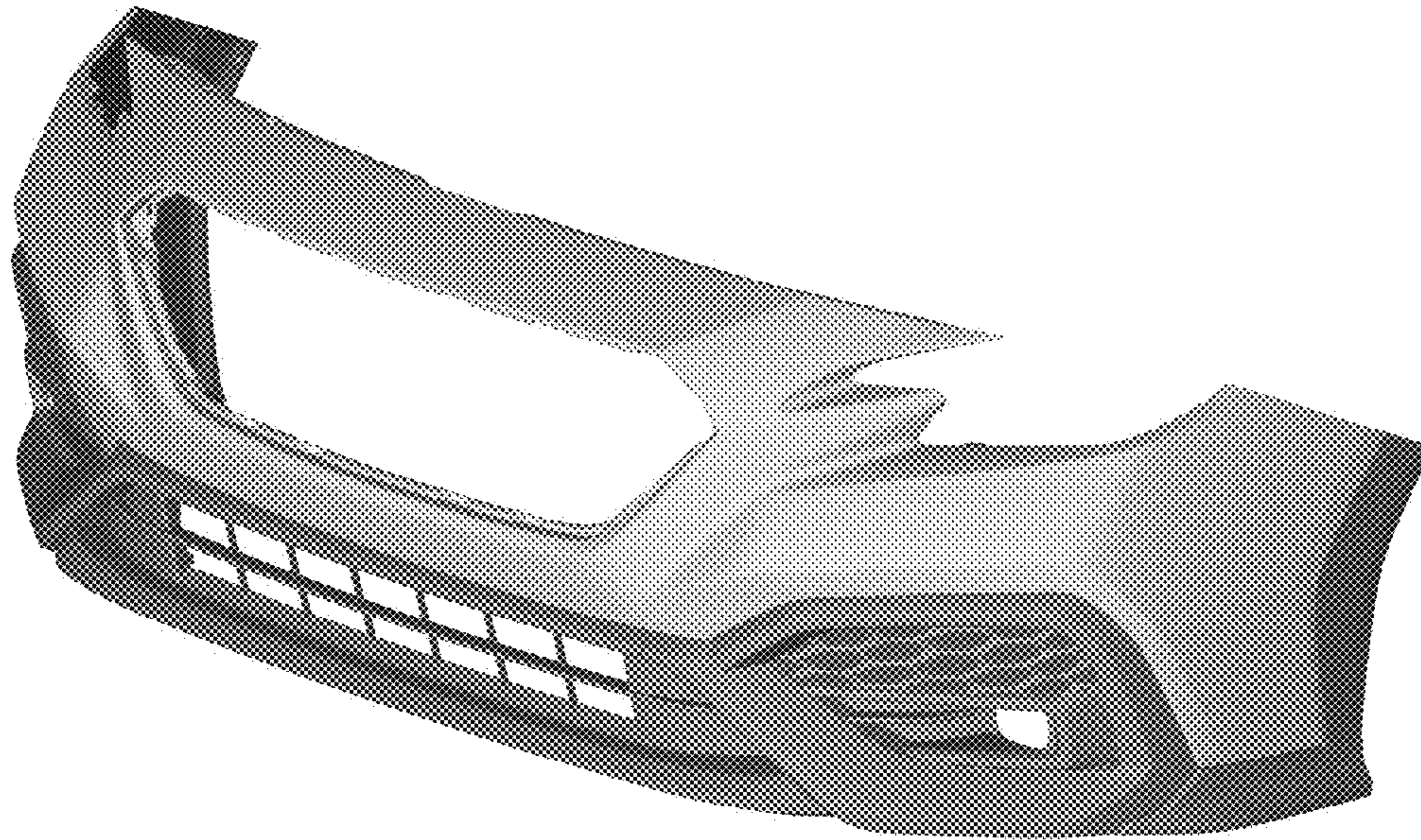

FIG. 2

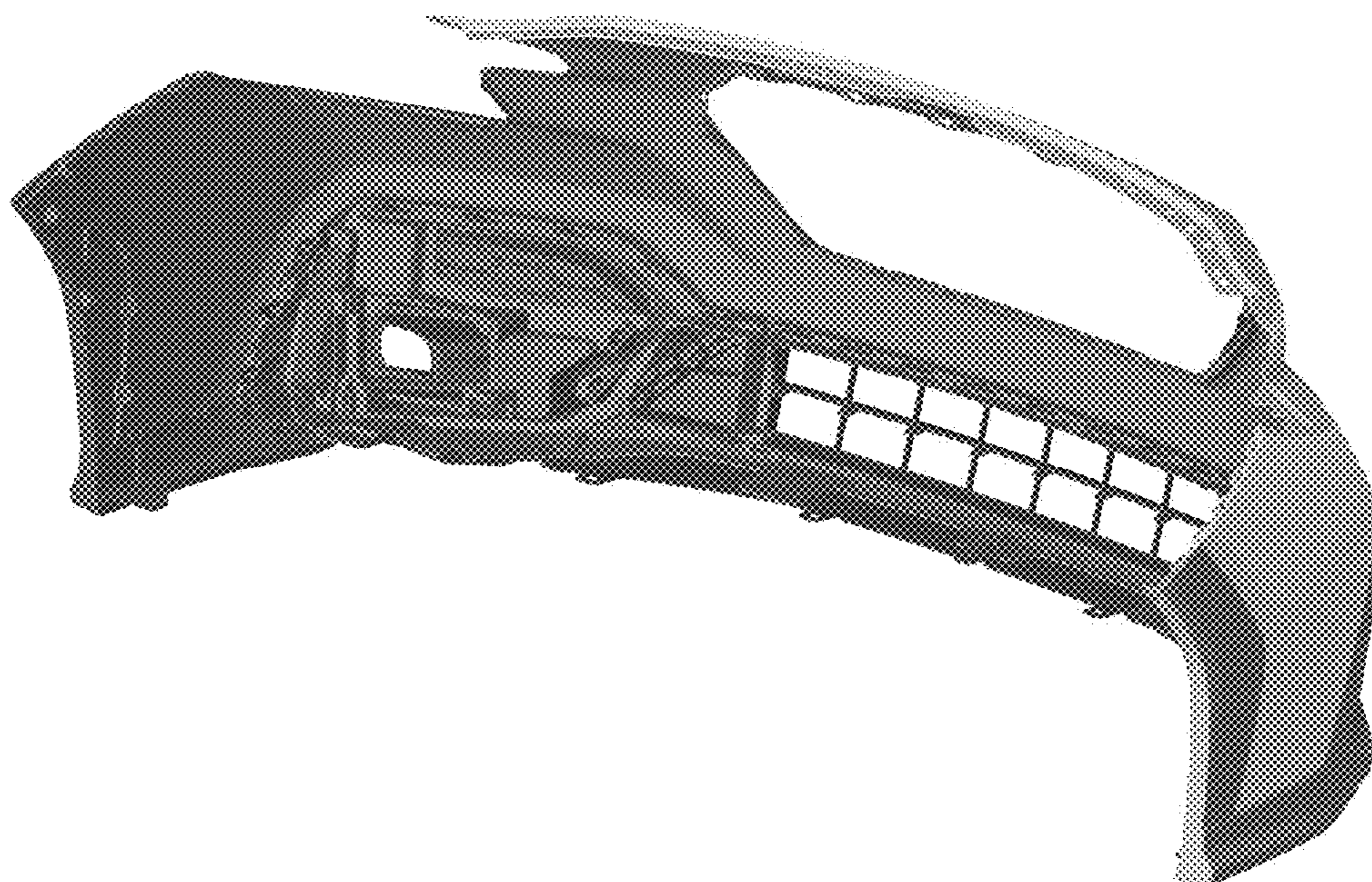

FIG. 3

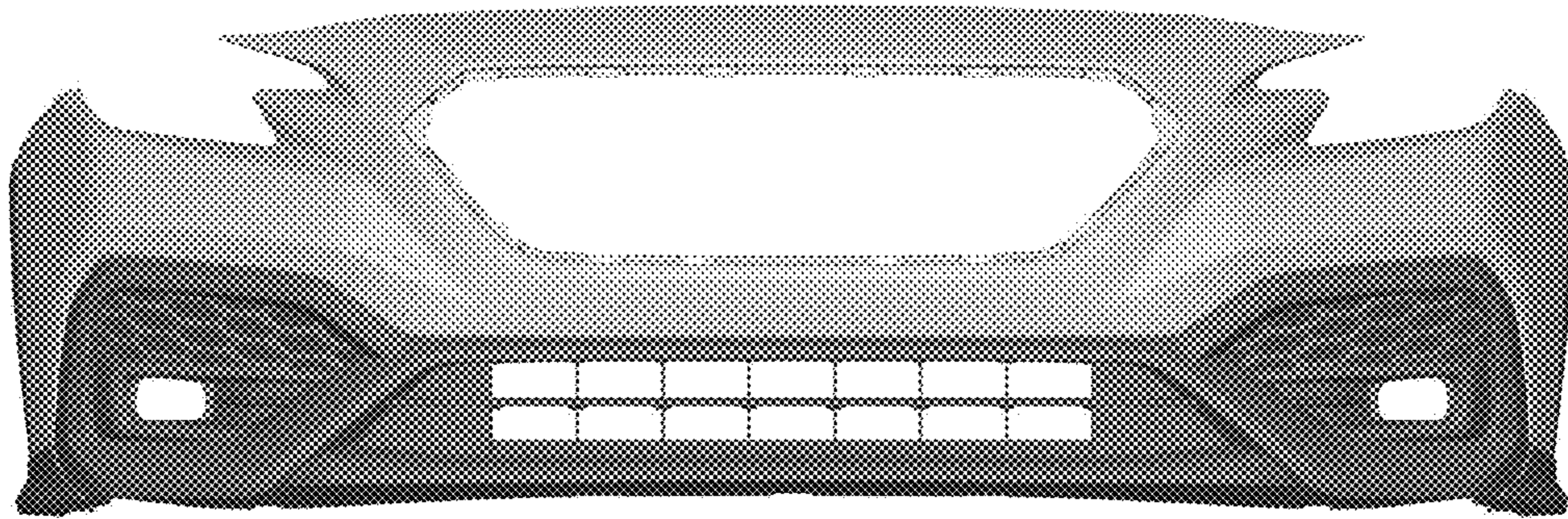

FIG. 4

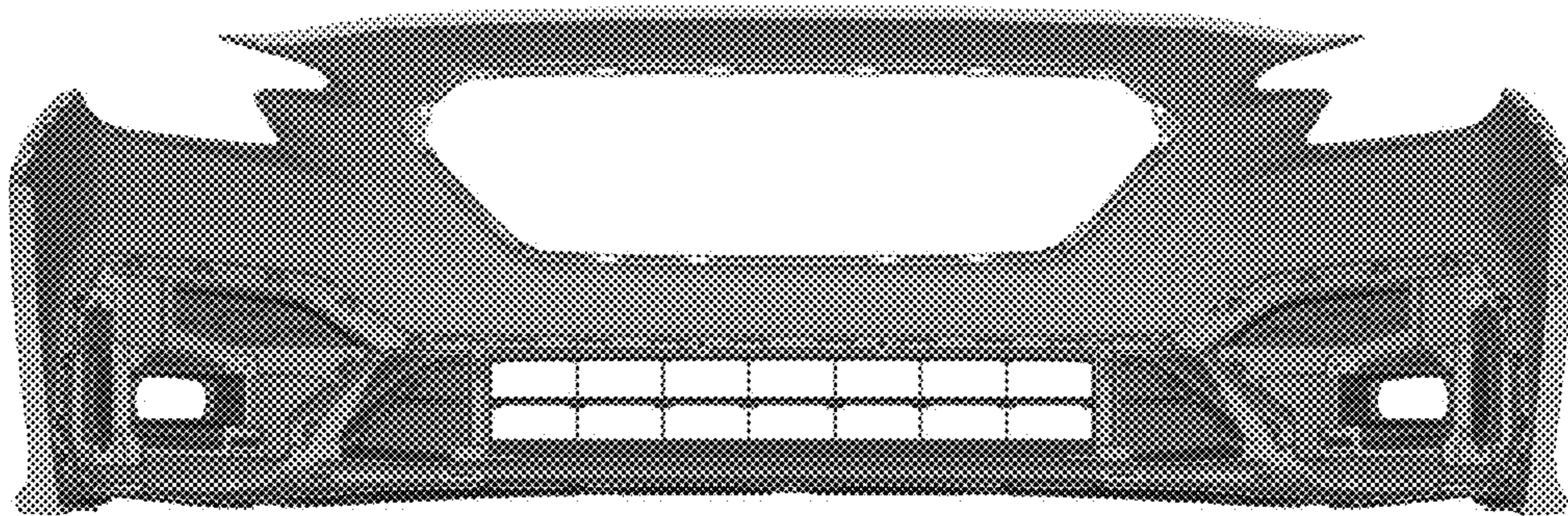

FIG. 5

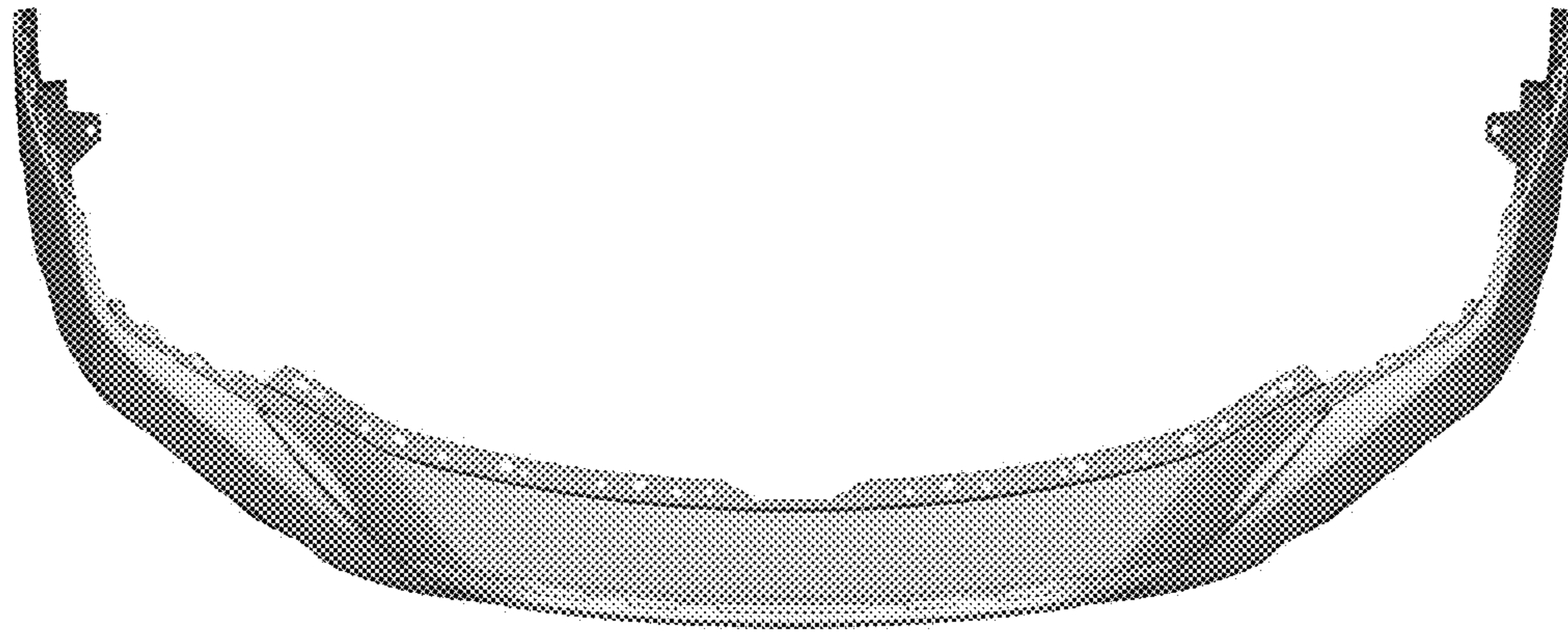

FIG. 6

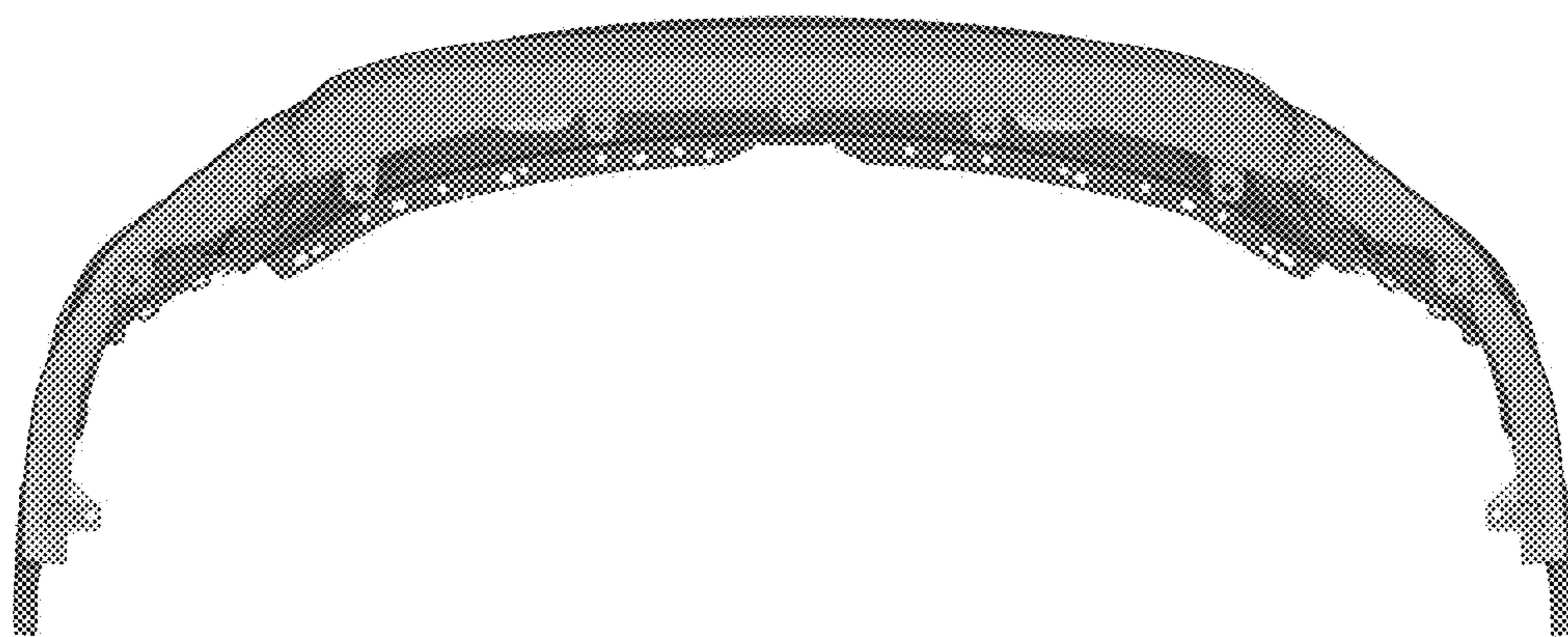

FIG. 7

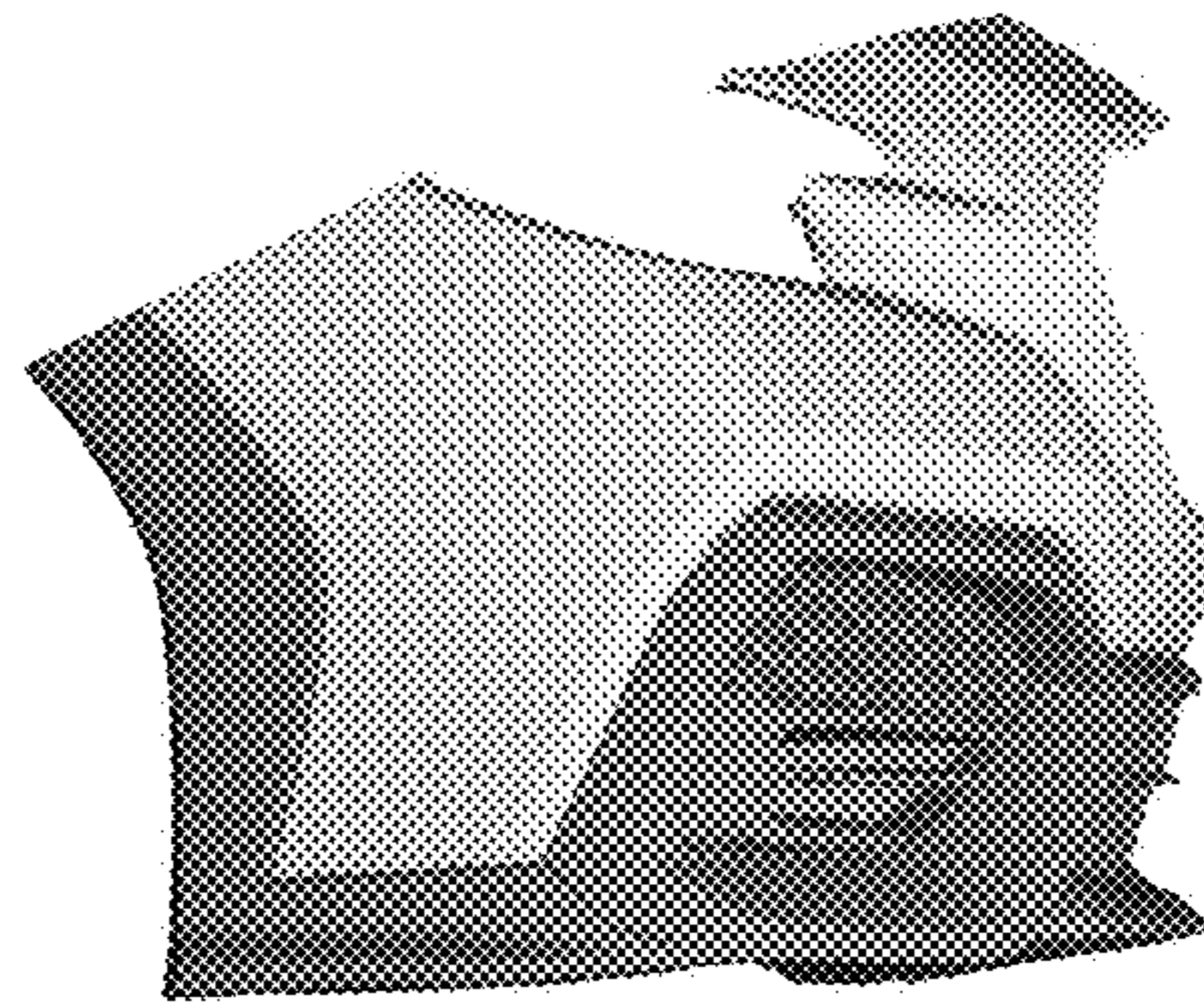

FIG. 8

